



# THE DATASHEET OF ST1802FX





# ST1802FX

## HIGH VOLTAGE FAST - SWITCHING NPN POWER TRANSISTOR

### Features

- NEW SERIES, ENHANCED PERFORMANCE
- FULLY INSULATED POWER PACKAGE (U.L. COMPLIANT) FOR EASY MOUNTING
- HIGH VOLTAGE CAPABILITY (>1500V)
- HIGH SWITCHING SPEED
- TIGHTER  $h_{FE}$  CONTROL
- IMPROVED RUGGEDNESS
- IN COMPLIANCE WITH THE 2002/93/EC EUROPEAN DIRECTIVE

### Applications

- HORIZONTAL DEFLECTION OUTPUT FOR COLOR TV UP TO 29-INCHES

### Description

The ST1802FX is manufactured using new Diffused Collector Technology for more stable operation Vs base drive circuit variations resulting in very low worst case dissipation.

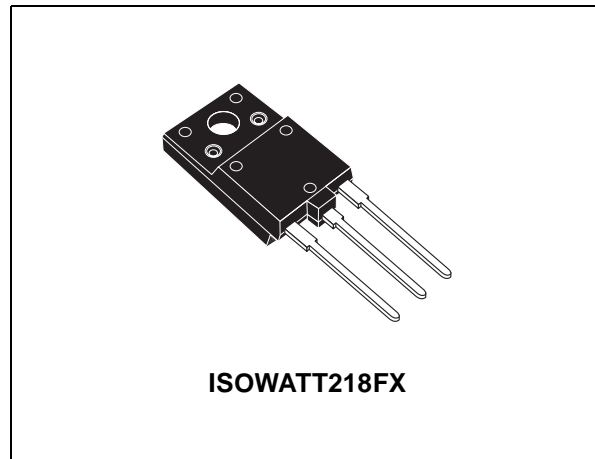

### Internal Schematic Diagram

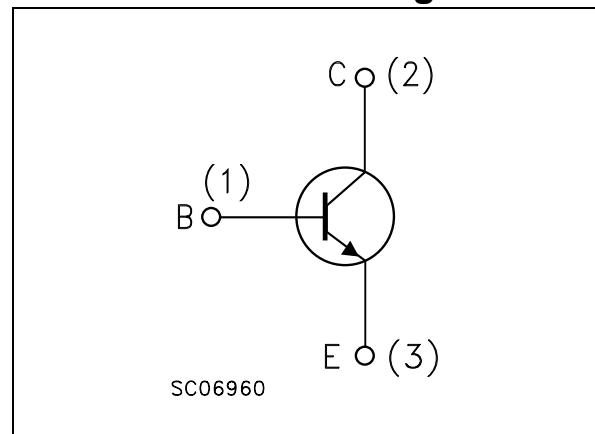

### Order codes

Part Number	Marking	Package	Packing
ST1802FX	1802FX	ISOWATT218FX	TUBE

# 1 Electrical Ratings

**Table 1. Absolute Maximum Rating**

Symbol	Parameter	Value	Unit
$V_{CBO}$	Collector-Base Voltage ( $I_E = 0$ )	1500	V
$V_{CEO}$	Collector-Emitter Voltage ( $I_B = 0$ )	600	V
$V_{EBO}$	Collector-Base Voltage ( $I_C = 0$ )	7	V
$I_C$	Collector Current	10	A
$I_{CM}$	Collector Peak Current ( $t_P < 5ms$ )	15	A
$I_B$	Base Current	4	A
$P_{TOT}$	Total dissipation at $T_C = 25^\circ C$	60	W
$V_{isol}$	Insulation Withstand Voltage (RMS) from all three Leads to External Heatsink	2500	V
$T_{stg}$	Storage Temperature	-65 to 150	°C
$T_J$	Max. Operating Junction Temperature	150	

**Table 2. Thermal Data**

Symbol	Parameter	Value	Unit
$R_{thj-case}$	Thermal Resistance Junction-Case Max	2.1	°C/W

## 2 Electrical Characteristics

( $T_{CASE} = 25^{\circ}C$ ; unless otherwise specified)

**Table 3. Electrical Characteristics**

Symbol	Parameter	Test Conditions	Min.	Typ.	Max.	Unit
$I_{CES}$	Collector Cut-off Current ( $V_{BE} = 0$ )	$V_{CE} = 1500V$			1	mA
		$V_{CE} = 1500V$ $T_C = 125^{\circ}C$			2	mA
$I_{EBO}$	Emitter Cut-off Current ( $I_C = 0$ )	$V_{EB} = 7V$			1	mA
$V_{CEO(sus)}$ <i>Note 1</i>	Collector-Emitter Sustaining Voltage ( $I_B = 0$ )	$I_C = 700\text{ mA}$ $L = 25\text{ mH}$	600			V
$V_{CE(sat)}$ <i>Note 1</i>	Collector-Emitter Saturation Voltage	$I_C = 4\text{ A}$ $I_B = 0.8\text{ A}$			5	V
		$I_C = 4\text{ A}$ $I_B = 1.2\text{ A}$			1.5	V
$V_{BE(sat)}$ <i>Note 1</i>	Base-Emitter Saturation Voltage	$I_C = 4.5\text{ A}$ $I_B = 1\text{ A}$			1.2	V
$h_{FE}$	DC Current Gain	$I_C = 1\text{ A}$ $V_{CE} = 5\text{ V}$		25		
		$I_C = 5\text{ A}$ $V_{CE} = 1\text{ V}$		4.5		
		$I_C = 5\text{ A}$ $V_{CE} = 5\text{ V}$	4		9	
$t_s$ $t_f$	INDUCTIVE LOAD	$I_C = 4A$ $f_h = 16KHz$				
	Storage Time	$I_{Bon(END)} = 850mA$		2.6	4	$\mu s$
	Fall Time	$V_{BB(off)} = -2.5V$ $L_B = 4.5\mu H$		0.2	0.6	$\mu s$

1 Pulsed duration = 300  $\mu s$ , duty cycle  $\leq 1.5\%$ .

## 2.1 Electrical Characteristics (curves)

Figure 1. Safe Operating Area

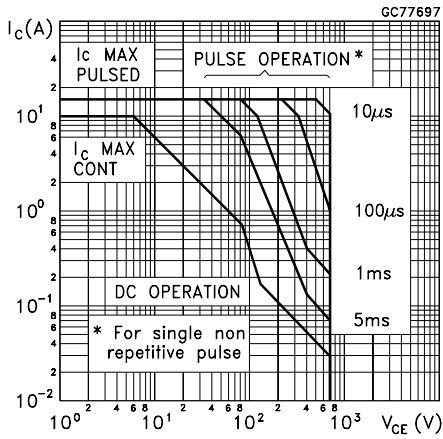

Figure 2. Thermal Impedance

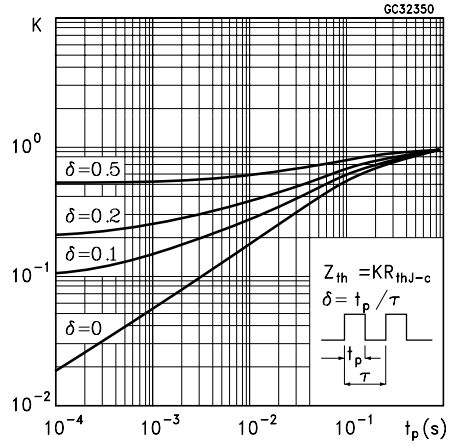

Figure 3. Collector-emitter saturation voltage

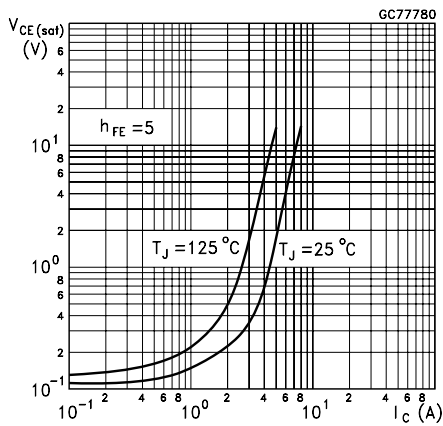

Figure 4. Base-emitter saturation voltage

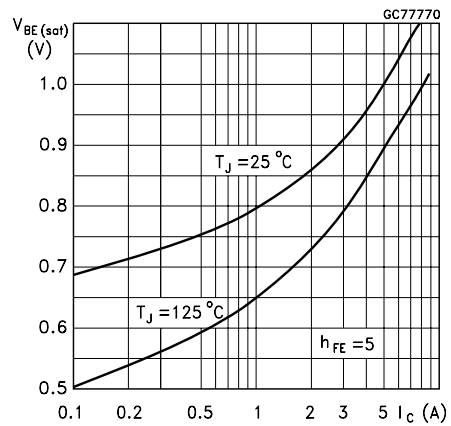

Figure 5. DC current gain

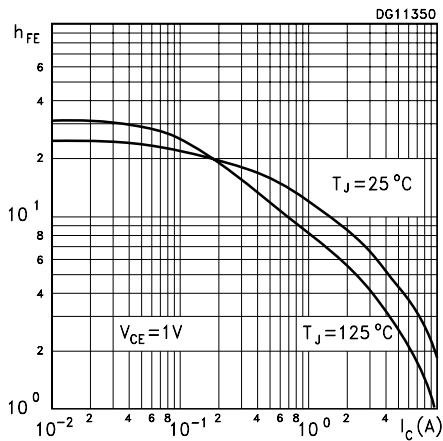

Figure 6. DC current gain

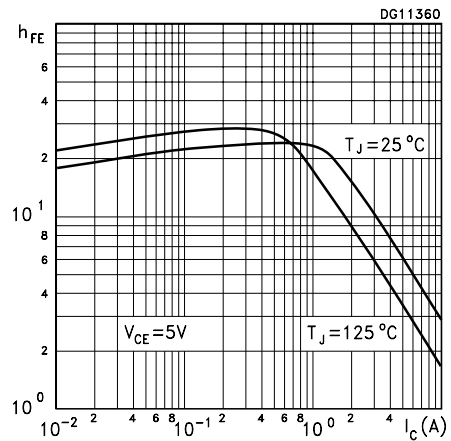

Figure 7. Power losses at 16KHz

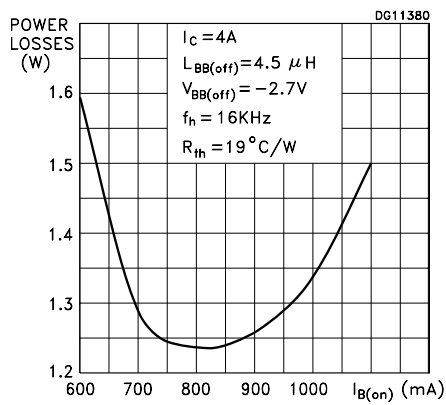

Figure 8. Switching time inductive load

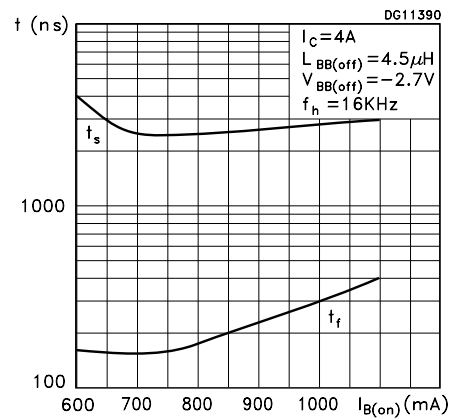
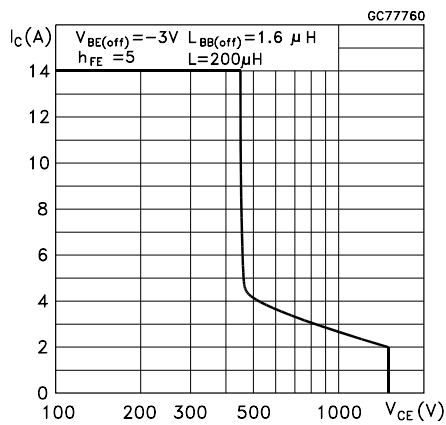
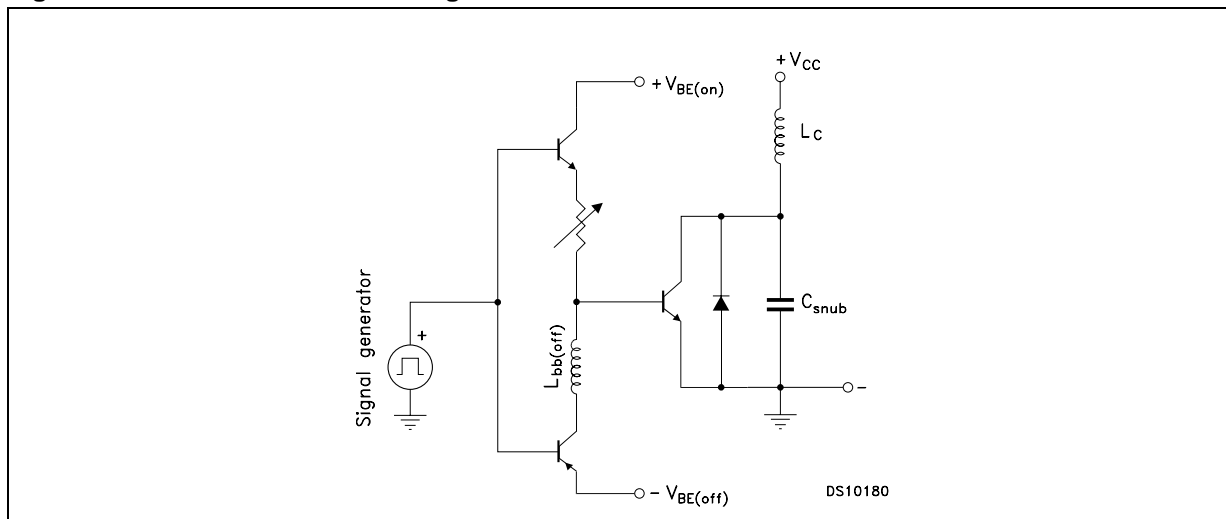

Figure 9. Reverse biased area



### 3 Test Circuit

Figure 10. Inductive load switching test circuit



## 4 Package Mechanical Data

In order to meet environmental requirements, ST offers these devices in ECOPACK® packages. These packages have a Lead-free second level interconnect . The category of second level interconnect is marked on the package and on the inner box label, in compliance with JEDEC Standard JESD97. The maximum ratings related to soldering conditions are also marked on the inner box label. ECOPACK is an ST trademark. ECOPACK specifications are available at: [www.st.com](http://www.st.com)

**ISOWATT218FX MECHANICAL DATA**

DIM.	mm.		
	MIN.	TYP	MAX.
A	5.30		5.70
C	2.80		3.20
D	3.10		3.50
D1	1.80		2.20
E	0.80		1.10
F	0.65		0.95
F2	1.80		2.20
G	10.30		11.50
G1		5.45	
H	15.30		15.70
L	9		10.20
L2	22.80		23.20
L3	26.30		26.70
L4	43.20		44.40
L5	4.30		4.70
L6	24.30		24.70
L7	14.60		15
N	1.80		2.20
R	3.80		4.20
Dia	3.40		3.80

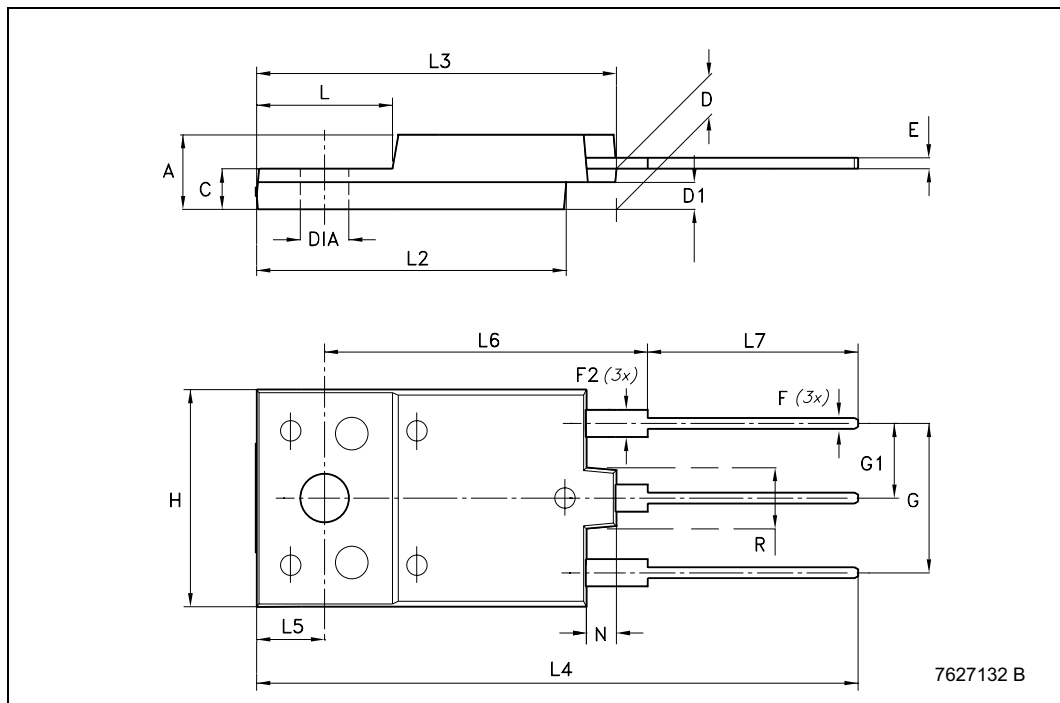

7627132 B

## 5 Revision History

Date	Revision	Changes
18-Oct-2005	1	First release

Information furnished is believed to be accurate and reliable. However, STMicroelectronics assumes no responsibility for the consequences of use of such information nor for any infringement of patents or other rights of third parties which may result from its use. No license is granted by implication or otherwise under any patent or patent rights of STMicroelectronics. Specifications mentioned in this publication are subject to change without notice. This publication supersedes and replaces all information previously supplied. STMicroelectronics products are not authorized for use as critical components in life support devices or systems without express written approval of STMicroelectronics.

The ST logo is a registered trademark of STMicroelectronics.  
All other names are the property of their respective owners

© 2005 STMicroelectronics - All rights reserved



STMicroelectronics group of companies

Australia - Belgium - Brazil - Canada - China - Czech Republic - Finland - France - Germany - Hong Kong - India - Israel - Italy - Japan -  
Malaysia - Malta - Morocco - Singapore - Spain - Sweden - Switzerland - United Kingdom - United States of America

[www.st.com](http://www.st.com)

## Looking for pricing, stock, or lifecycle information?

Click below to explore more details on WIN SOURCE:

-  [View ST1802FX on WIN SOURCE](#)
-  [STMicroelectronics Information](#)

## Optimize Your Supply Chain with WIN SOURCE Solutions

-  Global Sourcing Solution
-  Obsolete Management
-  Cost Control Management
-  Shortage Management
-  Alternative Solution
-  Excess Inventory Management