



# THE DATASHEET OF AOB298L



**General Description**

- Trench Power AlphaSGT™ technology
- Low  $R_{DS(ON)}$
- Low Gate Charge

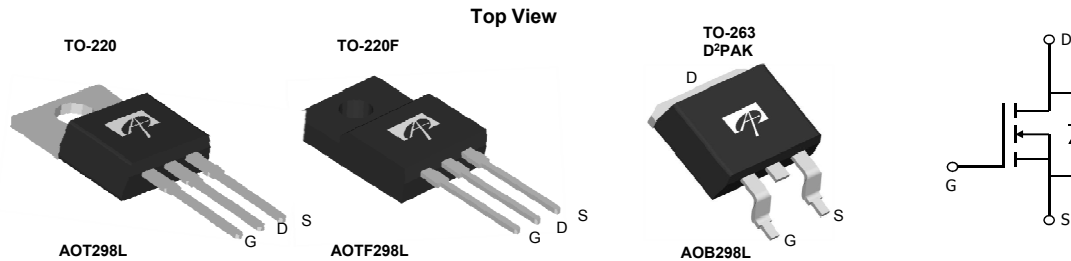
**Applications**

- Synchronous Rectification in DC/DC and AC/DC Converters
- Notebook Adaptor, TV Power Supply applications

**Product Summary**

$V_{DS}$	100V
$I_D$ (at $V_{GS}=10V$ )	58A/33A
$R_{DS(ON)}$ (at $V_{GS}=10V$ )	< 14.5m $\Omega$

100% UIS Tested  
 100%  $R_g$  Tested



Orderable Part Number	Package Type	Form	Minimum Order Quantity
AOT298L	TO-220	Tube	1000
AOB298L	TO-263	Tape & Reel	800
AOTF298L	TO-220F	Tube	1000

**Absolute Maximum Ratings  $T_A=25^\circ\text{C}$  unless otherwise noted**

Parameter	Symbol	AOT298L/AOB298L	AOTF298L	Units
Drain-Source Voltage	$V_{DS}$	100		V
Gate-Source Voltage	$V_{GS}$	$\pm 20$		V
Continuous Drain Current	$I_D$	$T_C=25^\circ\text{C}$	58	A
		$T_C=100^\circ\text{C}$	41	
Pulsed Drain Current <sup>C</sup>	$I_{DM}$	130		
Continuous Drain Current	$I_{DSM}$	$T_A=25^\circ\text{C}$	9	A
		$T_A=70^\circ\text{C}$	7	
Avalanche Current <sup>C</sup>	$I_{AS}, I_{AR}$	20		A
Avalanche energy $L=0.1\text{mH}$ <sup>C</sup>	$E_{AS}, E_{AR}$	20		mJ
$V_{DS}$ Spike <sup>I</sup>	$V_{SPIKE}$	120		V
Power Dissipation <sup>B</sup>	$P_D$	$T_C=25^\circ\text{C}$	100	W
		$T_C=100^\circ\text{C}$	50	
Power Dissipation <sup>A</sup>	$P_{DSM}$	$T_A=25^\circ\text{C}$	2.1	
		$T_A=70^\circ\text{C}$	1.33	
Junction and Storage Temperature Range	$T_J, T_{STG}$	-55 to 175		$^\circ\text{C}$

**Thermal Characteristics**

Parameter	Symbol	AOT298L/AOB298L	AOTF298L	Units
Maximum Junction-to-Ambient <sup>A</sup>	$R_{\theta JA}$	$t \leq 10\text{s}$	15	$^\circ\text{C/W}$
Maximum Junction-to-Ambient <sup>A,D</sup>		Steady-State	60	$^\circ\text{C/W}$
Maximum Junction-to-Case	$R_{\theta JC}$	1.5	4.5	$^\circ\text{C/W}$

**Electrical Characteristics (T<sub>J</sub>=25°C unless otherwise noted)**

Symbol	Parameter	Conditions	Min	Typ	Max	Units
<b>STATIC PARAMETERS</b>						
BV <sub>DSS</sub>	Drain-Source Breakdown Voltage	I <sub>D</sub> =250μA, V <sub>GS</sub> =0V	100			V
I <sub>DSS</sub>	Zero Gate Voltage Drain Current	V <sub>DS</sub> =100V, V <sub>GS</sub> =0V T <sub>J</sub> =55°C			1 5	μA
I <sub>GSS</sub>	Gate-Body leakage current	V <sub>DS</sub> =0V, V <sub>GS</sub> =±20V			±100	nA
V <sub>GS(th)</sub>	Gate Threshold Voltage	V <sub>DS</sub> =V <sub>GS</sub> , I <sub>D</sub> =250μA	2.7	3.3	4.1	V
I <sub>D(ON)</sub>	On state drain current	V <sub>GS</sub> =10V, V <sub>DS</sub> =5V	130			A
R <sub>DS(ON)</sub>	Static Drain-Source On-Resistance	V <sub>GS</sub> =10V, I <sub>D</sub> =20A T <sub>J</sub> =125°C		12 19	14.5 24	mΩ
g <sub>FS</sub>	Forward Transconductance	V <sub>DS</sub> =5V, I <sub>D</sub> =20A		30		S
V <sub>SD</sub>	Diode Forward Voltage	I <sub>S</sub> =1A, V <sub>GS</sub> =0V		0.7	1	V
I <sub>S</sub>	Maximum Body-Diode Continuous Current <sup>G</sup>				70	A
<b>DYNAMIC PARAMETERS</b>						
C <sub>iss</sub>	Input Capacitance	V <sub>GS</sub> =0V, V <sub>DS</sub> =50V, f=1MHz		1250	1670	pF
C <sub>oss</sub>	Output Capacitance			727	970	pF
C <sub>rss</sub>	Reverse Transfer Capacitance			25	43	pF
R <sub>g</sub>	Gate resistance	f=1MHz	0.8	2	3	Ω
<b>SWITCHING PARAMETERS</b>						
Q <sub>g(10V)</sub>	Total Gate Charge	V <sub>GS</sub> =10V, V <sub>DS</sub> =50V, I <sub>D</sub> =20A		19	27	nC
Q <sub>gs</sub>	Gate Source Charge			5.5		nC
Q <sub>gd</sub>	Gate Drain Charge			6		nC
t <sub>D(on)</sub>	Turn-On DelayTime	V <sub>GS</sub> =10V, V <sub>DS</sub> =50V, R <sub>L</sub> =2.5Ω, R <sub>GEN</sub> =3Ω		7.5		ns
t <sub>r</sub>	Turn-On Rise Time			14		ns
t <sub>D(off)</sub>	Turn-Off DelayTime			15		ns
t <sub>f</sub>	Turn-Off Fall Time			14		ns
t <sub>rr</sub>	Body Diode Reverse Recovery Time	I <sub>F</sub> =20A, dI/dt=500A/μs		39		ns
Q <sub>rr</sub>	Body Diode Reverse Recovery Charge	I <sub>F</sub> =20A, dI/dt=500A/μs		140		nC

A. The value of R<sub>θJA</sub> is measured with the device mounted on 1in<sup>2</sup> FR-4 board with 2oz. Copper, in a still air environment with T<sub>A</sub>=25° C. The Power dissipation P<sub>D(SM)</sub> is based on R<sub>θJA</sub> and the maximum allowed junction temperature of 150° C. The value in any given application depends on the user's specific board design, and the maximum temperature of 175° C may be used if the PCB allows it.

B. The power dissipation P<sub>D</sub> is based on T<sub>J(MAX)</sub>=175° C, using junction-to-case thermal resistance, and is more useful in setting the upper dissipation limit for cases where additional heatsinking is used.

C. Repetitive rating, pulse width limited by junction temperature T<sub>J(MAX)</sub>=175° C. Ratings are based on low frequency and duty cycles to keep initial T<sub>J</sub>=25° C.

D. The R<sub>θJA</sub> is the sum of the thermal impedance from junction to case R<sub>θJC</sub> and case to ambient.

E. The static characteristics in Figures 1 to 6 are obtained using <300μs pulses, duty cycle 0.5% max.

F. These curves are based on the junction-to-case thermal impedance which is measured with the device mounted to a large heatsink, assuming a maximum junction temperature of T<sub>J(MAX)</sub>=175° C. The SOA curve provides a single pulse rating.

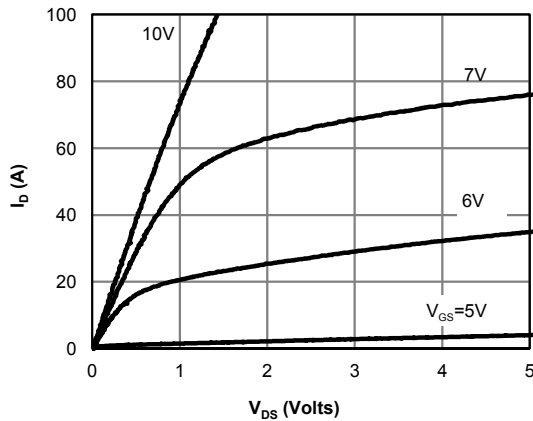
G. The maximum current limited by package.

H. These tests are performed with the device mounted on 1 in<sup>2</sup> FR-4 board with 2oz. Copper, in a still air environment with T<sub>A</sub>=25° C.

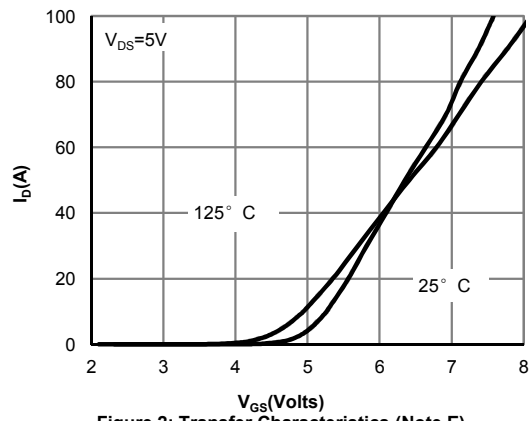
I. The spike duty cycle 5% max, limited by junction temperature T<sub>J(MAX)</sub>=120° C.

APPLICATIONS OR USE AS CRITICAL COMPONENTS IN LIFE SUPPORT DEVICES OR SYSTEMS ARE NOT AUTHORIZED. AOS DOES NOT ASSUME ANY LIABILITY ARISING OUT OF SUCH APPLICATIONS OR USES OF ITS PRODUCTS. AOS RESERVES THE RIGHT TO IMPROVE PRODUCT DESIGN,FUNCTIONS AND RELIABILITY WITHOUT NOTICE.

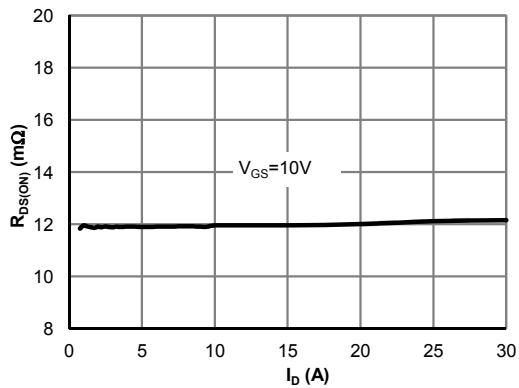
**TYPICAL ELECTRICAL AND THERMAL CHARACTERISTICS**



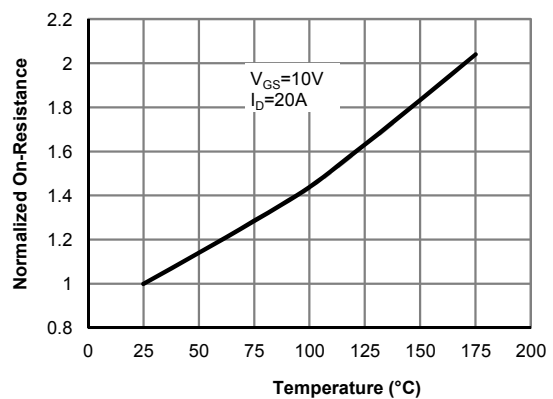
**Fig 1: On-Region Characteristics (Note E)**



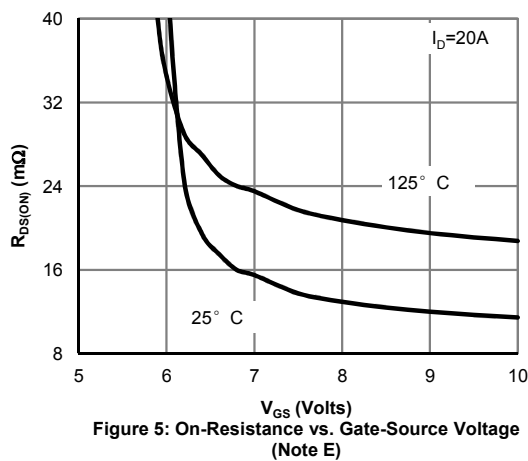
**Figure 2: Transfer Characteristics (Note E)**



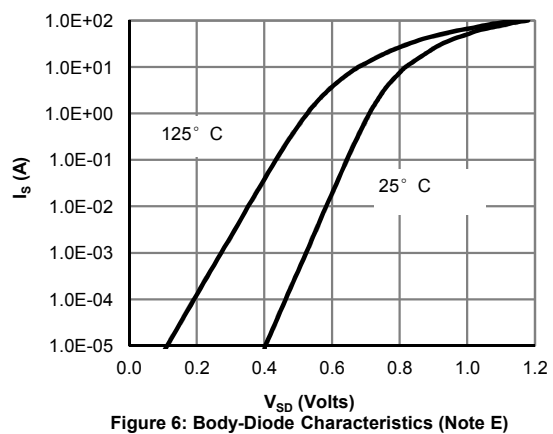
**Figure 3: On-Resistance vs. Drain Current and Gate Voltage (Note E)**



**Figure 4: On-Resistance vs. Junction Temperature (Note E)**

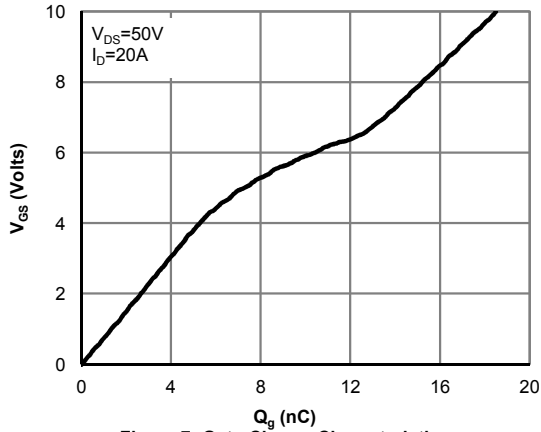


**Figure 5: On-Resistance vs. Gate-Source Voltage (Note E)**

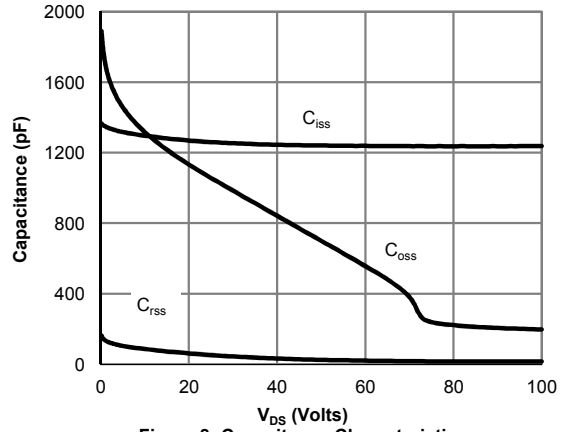


**Figure 6: Body-Diode Characteristics (Note E)**

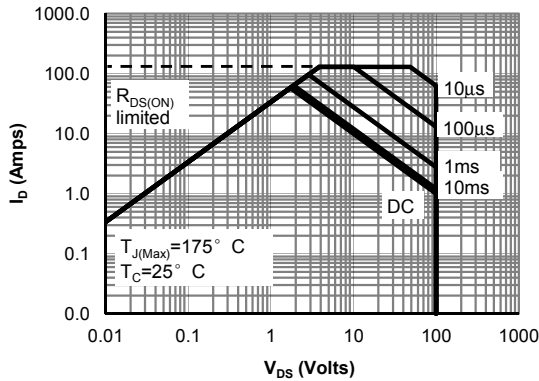
**TYPICAL ELECTRICAL AND THERMAL CHARACTERISTICS**



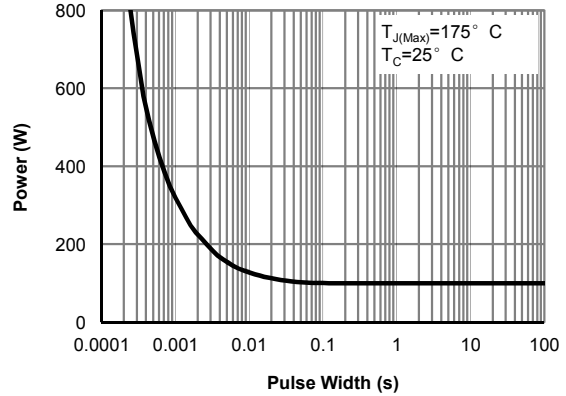
**Figure 7: Gate-Charge Characteristics**



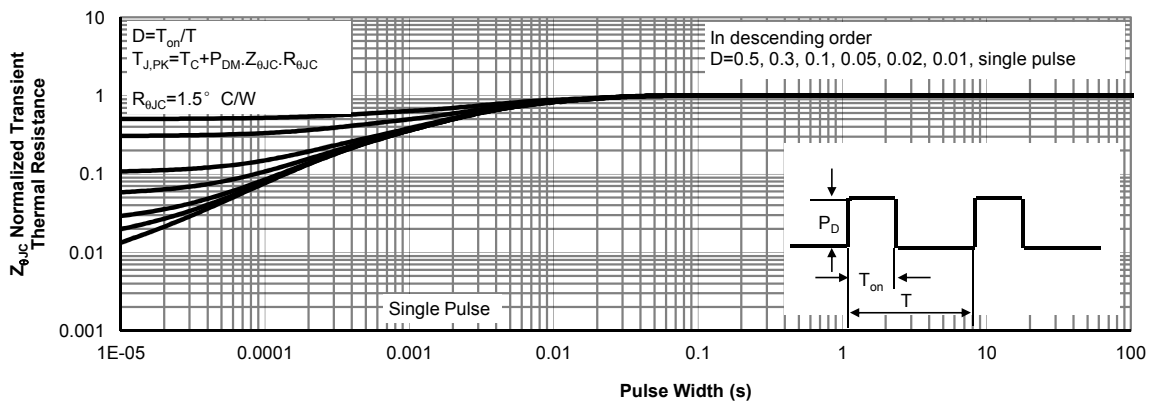
**Figure 8: Capacitance Characteristics**



**Figure 9: Maximum Forward Biased Safe Operating Area for AOT298L and AOB298L (Note F)**

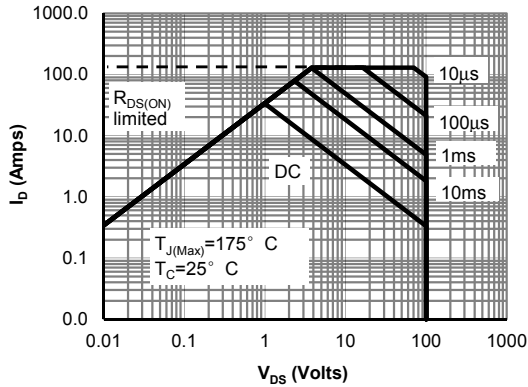


**Figure 10: Single Pulse Power Rating Junction-to-Case for AOT298L and AOB298L (Note F)**

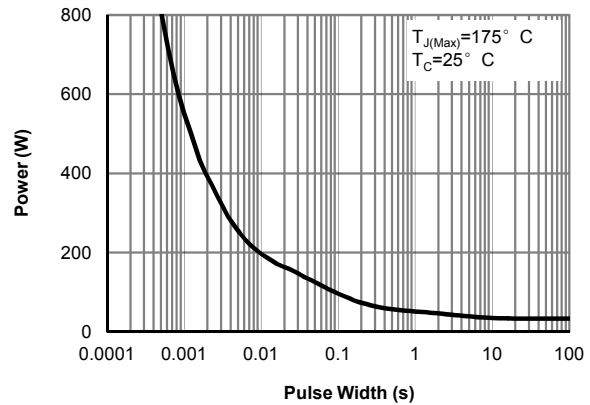


**Figure 11: Normalized Maximum Transient Thermal Impedance for AOT298L and AOB298L (Note F)**

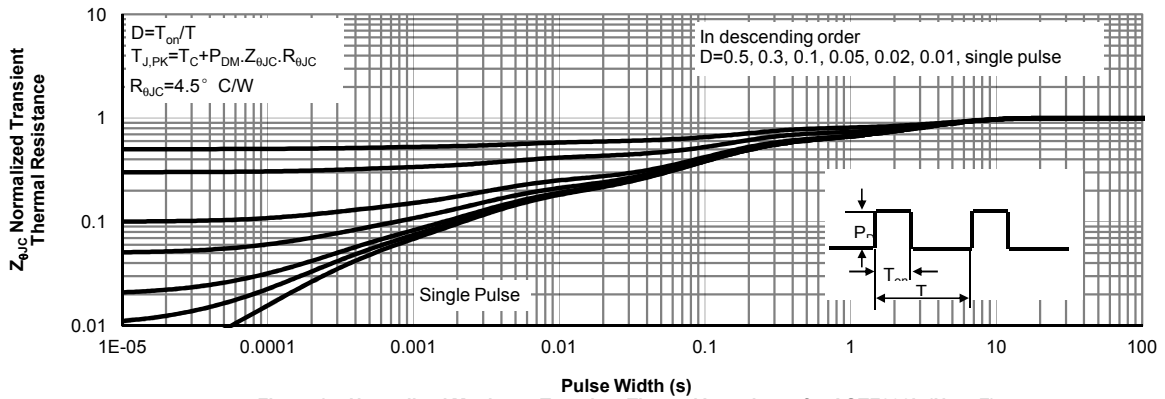
**TYPICAL ELECTRICAL AND THERMAL CHARACTERISTICS**



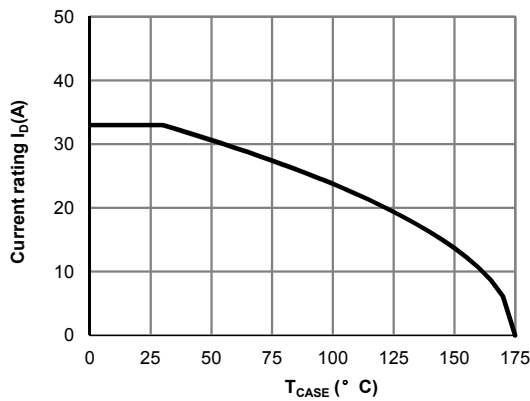
**Figure 12: Maximum Forward Biased Safe Operating Area for AOTF298L (Note F)**



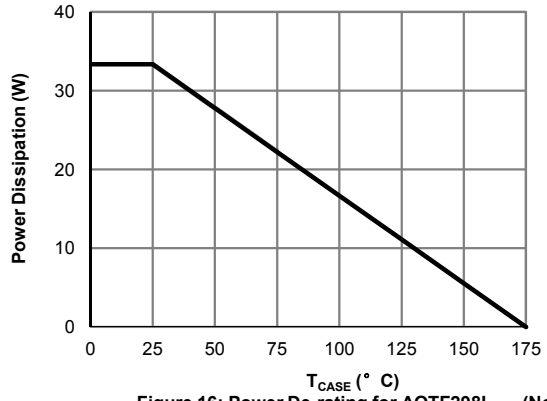
**Figure 13: Single Pulse Power Rating Junction-to-Case for AOTF298L (Note F)**



**Figure 14: Normalized Maximum Transient Thermal Impedance for AOTF298L (Note F)**



**Figure 15: Current De-rating for AOTF298L (Note F)**



**Figure 16: Power De-rating for AOTF298L (Note F)**

**TYPICAL ELECTRICAL AND THERMAL CHARACTERISTICS**

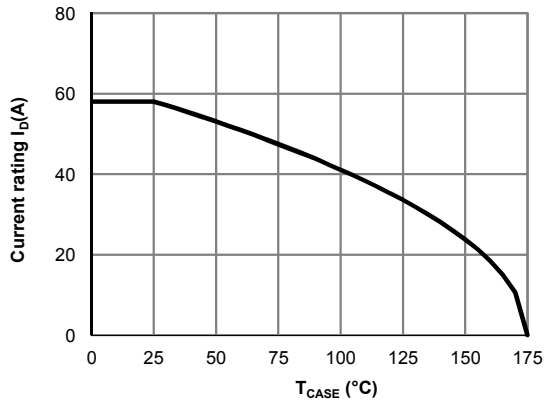


Figure 17: Current De-rating for AOT298L and AOB298L (Note F)

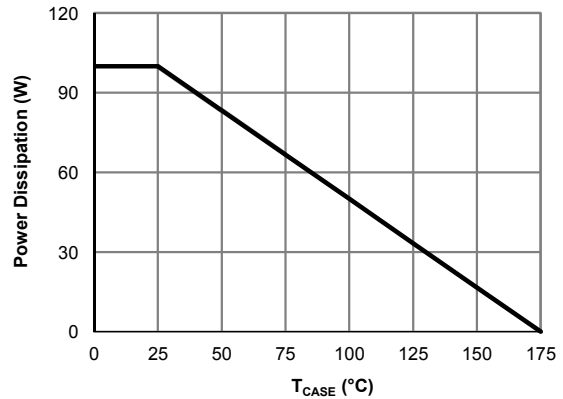


Figure 18: Power De-rating for AOT298L and AOB298L (Note F)

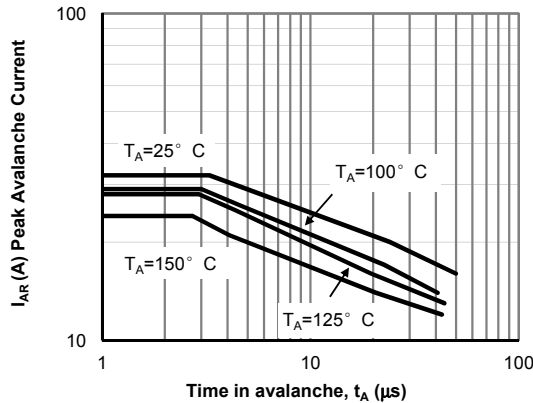


Figure 19: Single Pulse Avalanche capability (Note C)

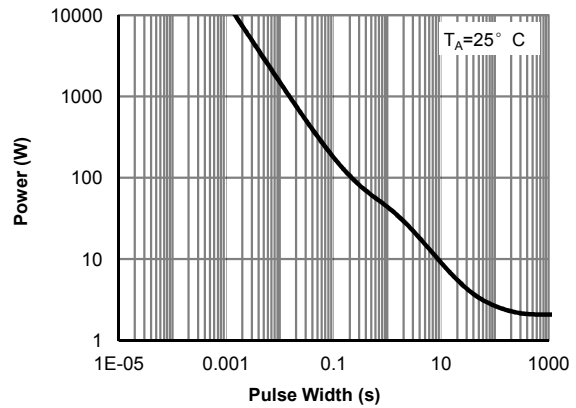


Figure 20: Single Pulse Power Rating Junction-to-Ambient (Note H)

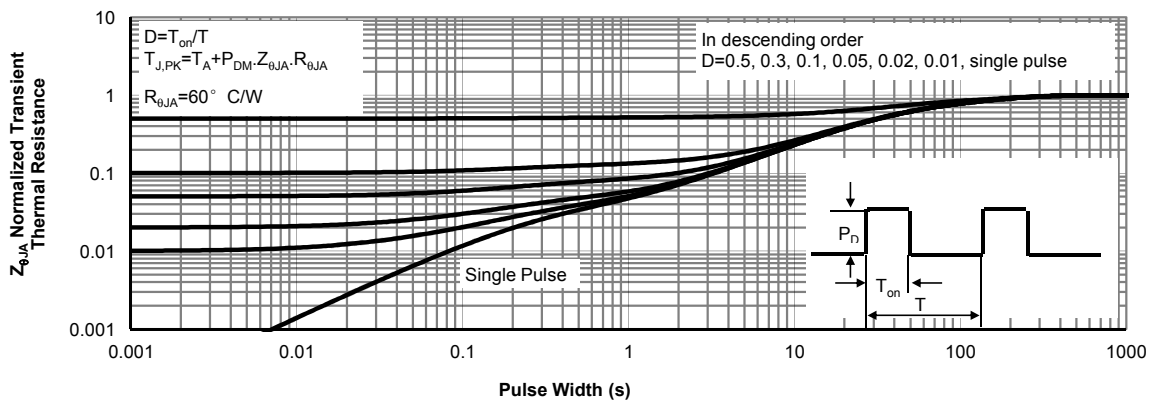
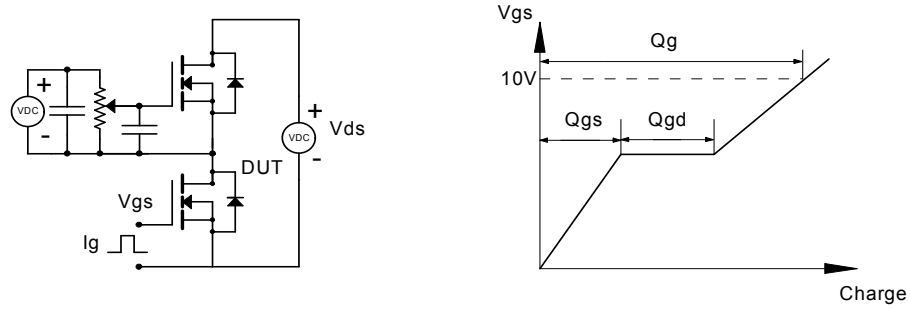
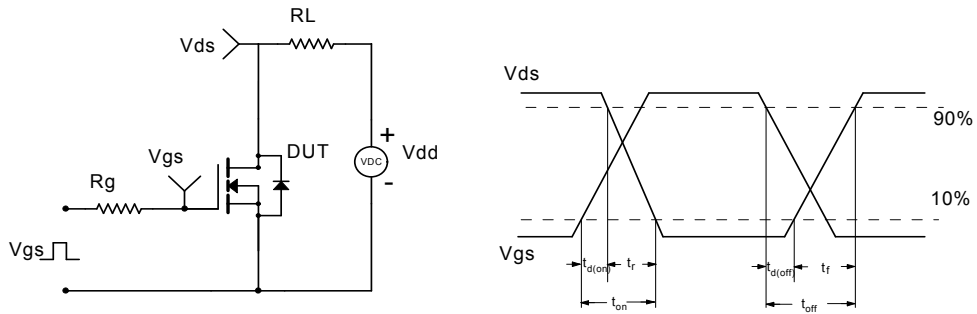


Figure 21: Normalized Maximum Transient Thermal Impedance (Note H)

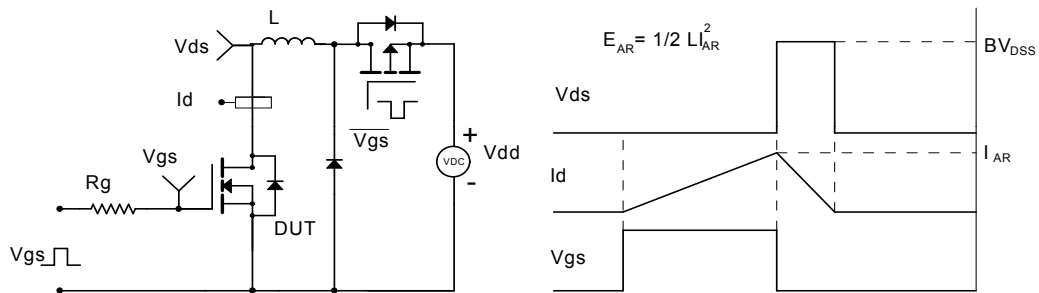
**Gate Charge Test Circuit & Waveform**



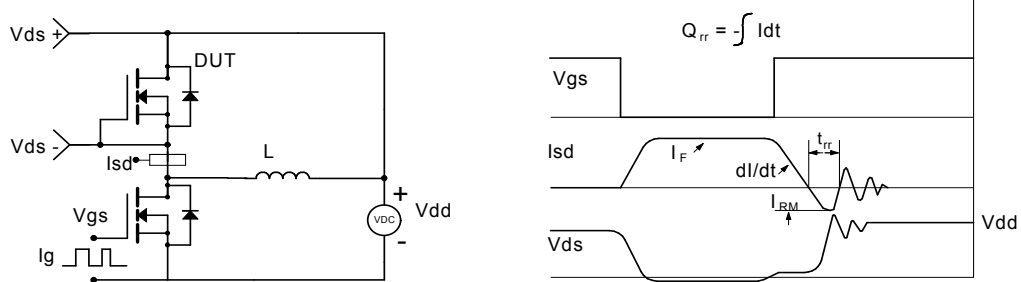
**Resistive Switching Test Circuit & Waveforms**



**Unclamped Inductive Switching (UIS) Test Circuit & Waveforms**



**Diode Recovery Test Circuit & Waveforms**



## Looking for pricing, stock, or lifecycle information?

Click below to explore more details on WIN SOURCE:

- ⊖ [View AOB298L on WIN SOURCE](#)
- ⊖ [Alpha & Omega Semiconductor Inc. Information](#)

## Optimize Your Supply Chain with WIN SOURCE Solutions

- ✓ Global Sourcing Solution
- ✓ Obsolete Management
- ✓ Cost Control Management
- ✓ Shortage Management
- ✓ Alternative Solution
- ✓ Excess Inventory Management