



**THE DATASHEET OF
AON4703**



20V P-Channel MOSFET with Schottky Diode

General Description

The AON4703 uses advanced trench technology to provide excellent $R_{DS(ON)}$ and low gate charge. A Schottky diode is provided to facilitate the implementation of a bidirectional blocking switch, or for buck converter applications.

Features

V_{DS} (V) = -20V
 $I_D = -3.4A$ ($V_{GS} = -4.5V$)
 $R_{DS(ON)} < 90m\Omega$ ($V_{GS} = -4.5V$)
 $R_{DS(ON)} < 120m\Omega$ ($V_{GS} = -2.5V$)
 $R_{DS(ON)} < 160m\Omega$ ($V_{GS} = -1.8V$)
SCHOTTKY
 V_{KA} (V) = 20V, $I_F = 1A$, $V_F < 0.5V @ 1A$

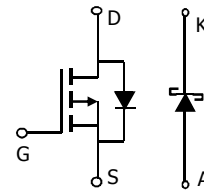
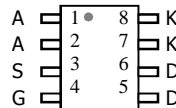
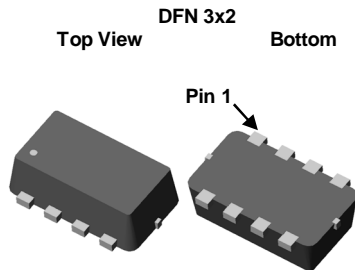

Absolute Maximum Ratings $T_A=25^\circ C$ unless otherwise noted

Parameter	Symbol	MOSFET	Schottky	Units
Drain-Source Voltage	V_{DS}	-20		V
Gate-Source Voltage	V_{GS}	± 8		V
Continuous Drain Current ^A	$T_A=25^\circ C$	-3.4		A
	$T_A=70^\circ C$	-2.7		
Pulsed Drain Current ^B	I_{DM}	-15		
Schottky reverse voltage	V_{KA}		20	V
Continuous Forward Current ^A	$T_A=25^\circ C$		1.9	A
	$T_A=70^\circ C$		1.2	
Pulsed Forward Current ^B	I_{FM}		7	
Power Dissipation	$T_A=25^\circ C$	P_D	1.7	W
	$T_A=70^\circ C$		1.1	
Junction and Storage Temperature Range	T_J, T_{STG}	-55 to 150	-55 to 150	$^\circ C$

Parameter: Thermal Characteristics MOSFET		Symbol	Typ	Max	Units
Maximum Junction-to-Ambient ^A	$t \leq 10s$	$R_{\theta JA}$	51	75	$^\circ C/W$
	Steady-State		88	110	
Maximum Junction-to-Lead ^C	Steady-State	$R_{\theta JL}$	28	35	
Thermal Characteristics Schottky					
Maximum Junction-to-Ambient ^A	$t \leq 10s$	$R_{\theta JA}$	66	80	$^\circ C/W$
	Steady-State		95	130	
Maximum Junction-to-Lead ^C	Steady-State	$R_{\theta JL}$	40	50	

Electrical Characteristics (T_J=25°C unless otherwise noted)

Symbol	Parameter	Conditions	Min	Typ	Max	Units
STATIC PARAMETERS						
BV _{DSS}	Drain-Source Breakdown Voltage	I _D =-250μA, V _{GS} =0V	-20			V
I _{DSS}	Zero Gate Voltage Drain Current	V _{DS} =-20V, V _{GS} =0V T _J =55°C			-1 -5	μA
I _{GSS}	Gate-Body leakage current	V _{DS} =0V, V _{GS} =±8V			±100	nA
V _{GS(th)}	Gate Threshold Voltage	V _{DS} =V _{GS} , I _D =-250μA	-0.4	-0.65	-1	V
I _{D(ON)}	On state drain current	V _{GS} =-4.5V, V _{DS} =-5V	-15			A
R _{DS(ON)}	Static Drain-Source On-Resistance	V _{GS} =-4.5V, I _D =-3.4A T _J =125°C		51 64	90 135	mΩ
		V _{GS} =-2.5V, I _D =-2.5A		65	120	mΩ
		V _{GS} =-1.8V, I _D =-1.5A		83	160	mΩ
g _{FS}	Forward Transconductance	V _{DS} =-5V, I _D =-3.4A		12		S
V _{SD}	Diode Forward Voltage	I _S =-1A, V _{GS} =0V		-0.7	-1	V
I _S	Maximum Body-Diode Continuous Current				-2	A
DYNAMIC PARAMETERS						
C _{ISS}	Input Capacitance	V _{GS} =0V, V _{DS} =-10V, f=1MHz		560	745	pF
C _{OSS}	Output Capacitance		80		pF	
C _{RSS}	Reverse Transfer Capacitance		70		pF	
R _g	Gate resistance	V _{GS} =0V, V _{DS} =0V, f=1MHz		15	23	Ω
SWITCHING PARAMETERS						
Q _g	Total Gate Charge	V _{GS} =-4.5V, V _{DS} =-10V, I _D =-3.4A		8.5	11	nC
Q _{gs}	Gate Source Charge		1.2		nC	
Q _{gd}	Gate Drain Charge		2.1		nC	
t _{D(on)}	Turn-On Delay Time	V _{GS} =-4.5V, V _{DS} =-10V, R _L =2.9Ω, R _{GEN} =3Ω		7.2		ns
t _r	Turn-On Rise Time		36		ns	
t _{D(off)}	Turn-Off Delay Time		53		ns	
t _f	Turn-Off Fall Time		56		ns	
t _{rr}	Body Diode Reverse Recovery Time	I _F =-3.4A, di/dt=100A/μs		37	49	ns
Q _{rr}	Body Diode Reverse Recovery Charge	I _F =-3.4A, di/dt=100A/μs		27		nC
SCHOTTKY PARAMETERS						
V _F	Forward Voltage Drop	I _F =1A		0.4	0.5	V
I _{rm}	Maximum reverse leakage current	V _R =16V			0.2	mA
		V _R =16V, T _J =125°C			20	
C _T	Junction Capacitance	V _R =10V		44		pF
t _{rr}	Schottky Reverse Recovery Time	I _F =1A, di/dt=100A/μs		11	14	ns
Q _{rr}	Schottky Reverse Recovery Charge	I _F =1A, di/dt=100A/μs		2.5		nC

A: The value of R_{θJA} is measured with the device mounted on 1in² FR-4 board with 2oz. Copper, in a still air environment with T_A = 25° C. The value in any given application depends on the user's specific board design.

B: Repetitive rating, pulse width limited by junction temperature.

C: The R_{θJA} is the sum of the thermal impedance from junction to lead R_{θJL} and lead to ambient.

D: The static characteristics in Figures 1 to 6 are obtained using t ≤ 300μs pulses, duty cycle 0.5% max.

E: These tests are performed with the device mounted on 1 in² FR-4 board with 2oz. Copper, in a still air environment with T_A=25° C. The SOA curve provides a single pulse rating.

F: The current rating is based on the t ≤ 10s thermal resistance rating.

COMPONENTS IN LIFE SUPPORT DEVICES OR SYSTEMS ARE NOT AUTHORIZED. AOS DOES NOT ASSUME ANY LIABILITY ARISING OUT OF SUCH APPLICATIONS OR USES OF ITS PRODUCTS. AOS RESERVES THE RIGHT TO IMPROVE PRODUCT DESIGN, FUNCTIONS AND RELIABILITY WITHOUT NOTICE.

TYPICAL ELECTRICAL AND THERMAL CHARACTERISTICS

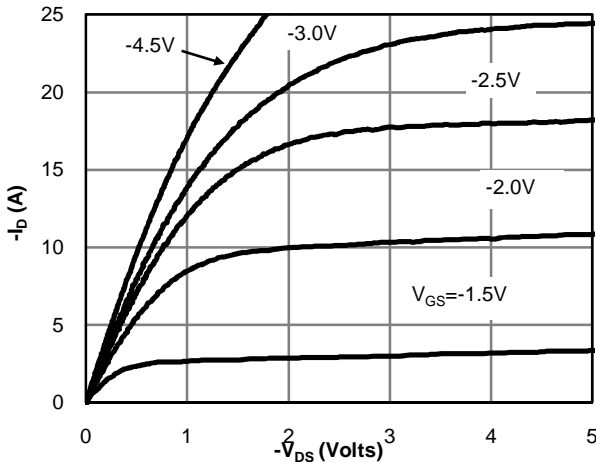

Fig 1: On-Region Characteristics

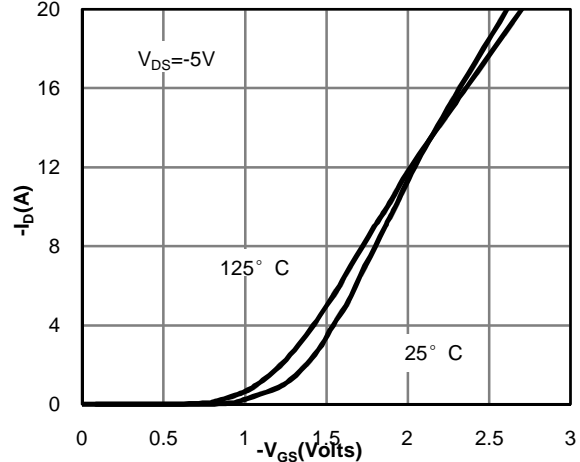

Figure 2: Transfer Characteristics

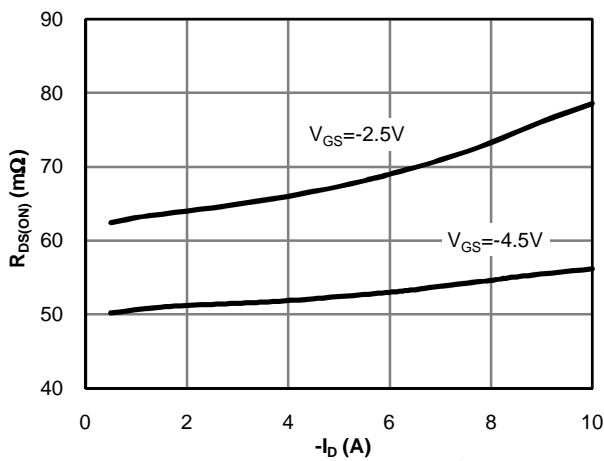

Figure 3: On-Resistance vs. Drain Current and Gate Voltage

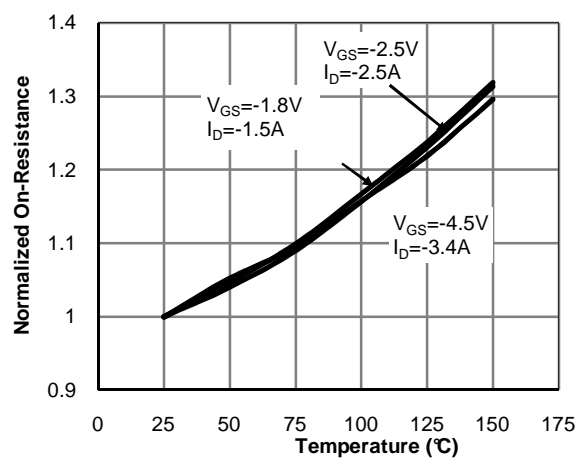

Figure 4: On-Resistance vs. Junction Temperature

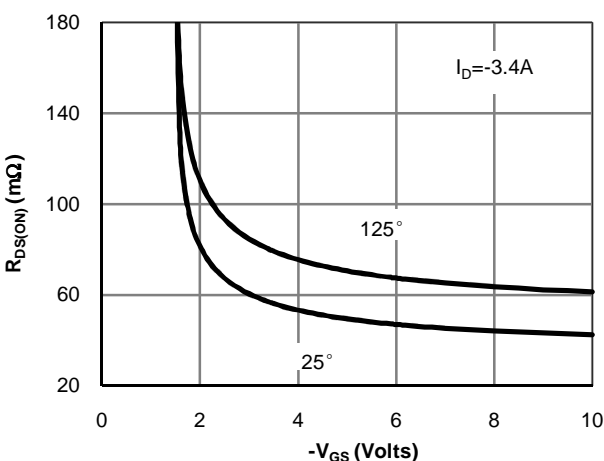

Figure 5: On-Resistance vs. Gate-Source Voltage

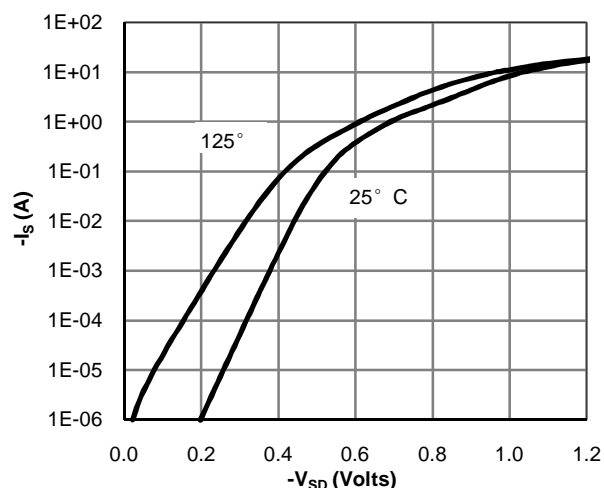

Figure 6: Body-Diode Characteristics

TYPICAL ELECTRICAL AND THERMAL CHARACTERISTICS

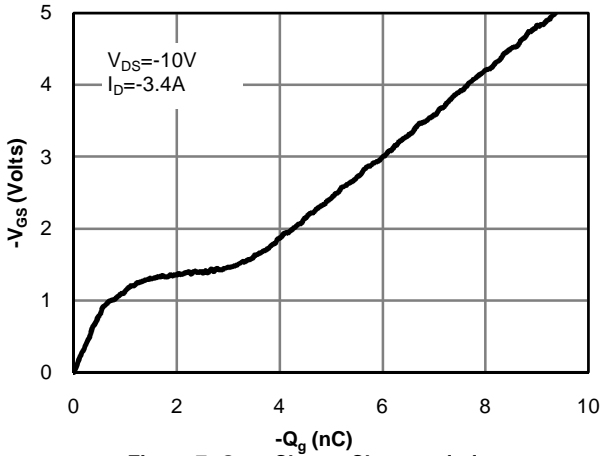

Figure 7: Gate-Charge Characteristics

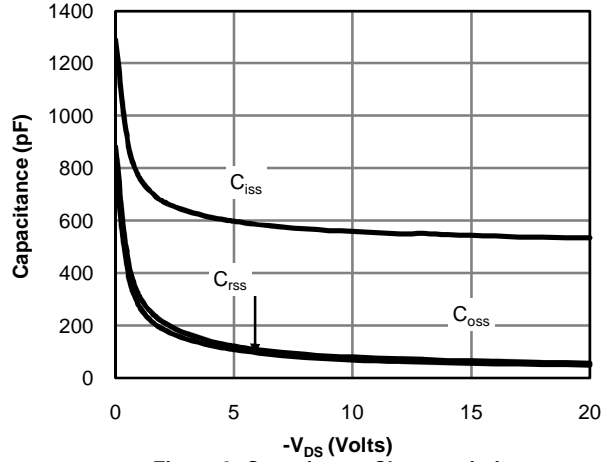

Figure 8: Capacitance Characteristics

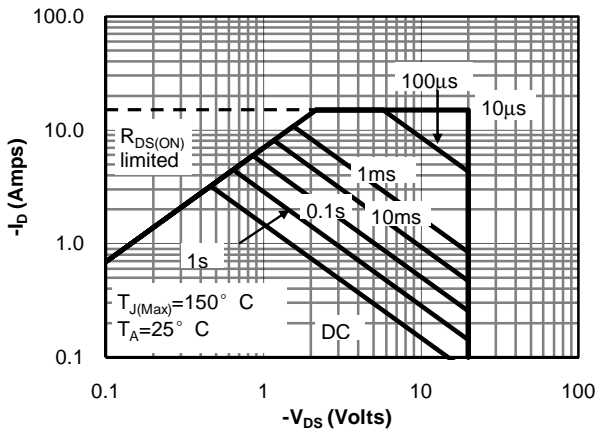

Figure 9: Maximum Forward Biased Safe Operating Area (Note E)

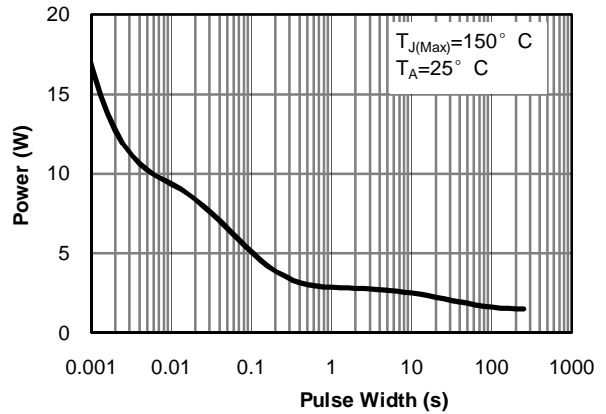

Figure 10: Single Pulse Power Rating Junction-to-Ambient (Note E)

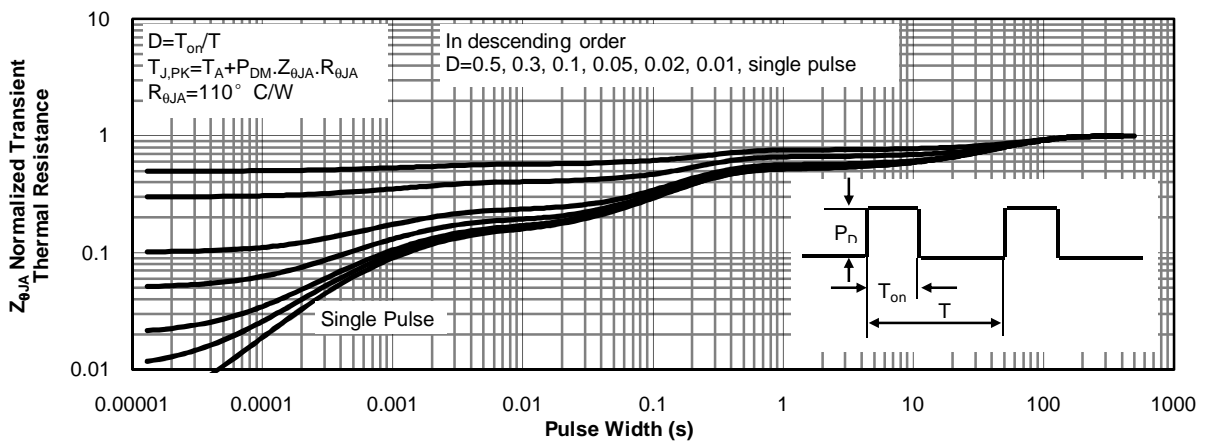

Figure 11: Normalized Maximum Transient Thermal Impedance

TYPICAL ELECTRICAL AND THERMAL CHARACTERISTICS: SCHOTTKY

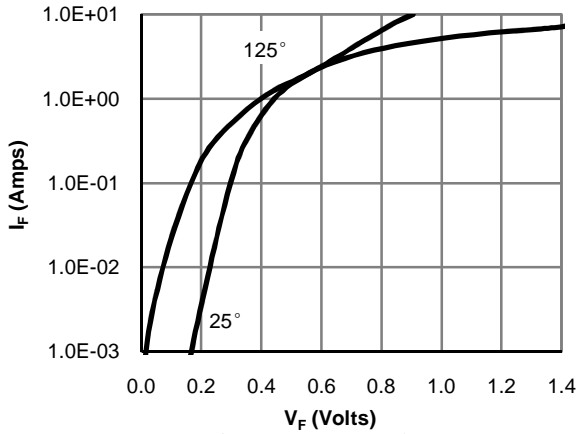

Figure 12: Schottky Forward Characteristics

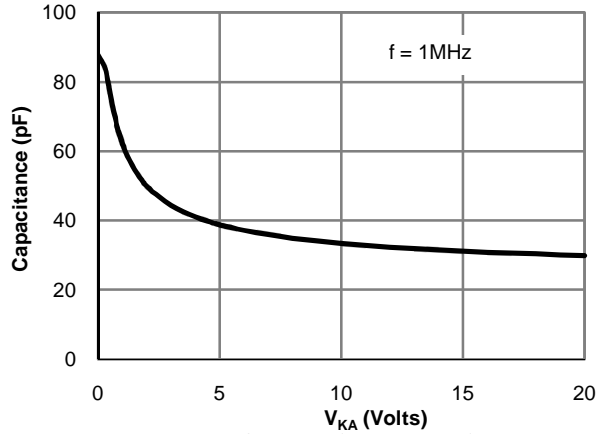

Figure 13: Schottky Capacitance Characteristics

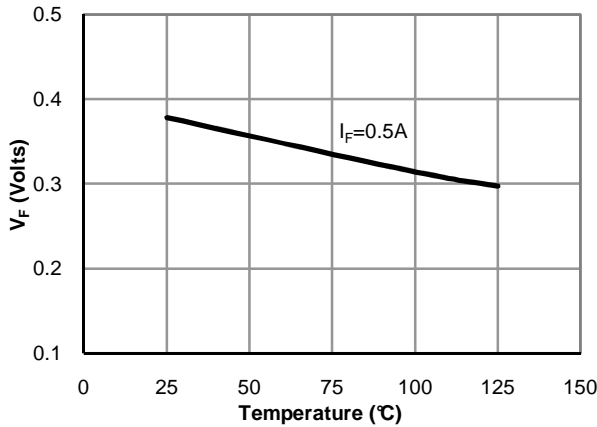

Figure 14: Schottky Forward Drop vs. Junction Temperature

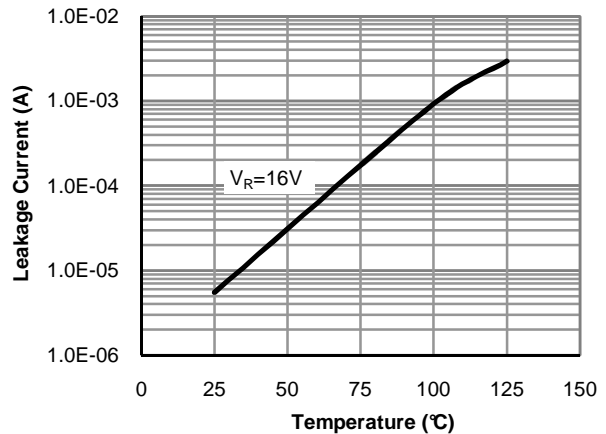

Figure 15: Schottky Leakage current vs. Junction Temperature

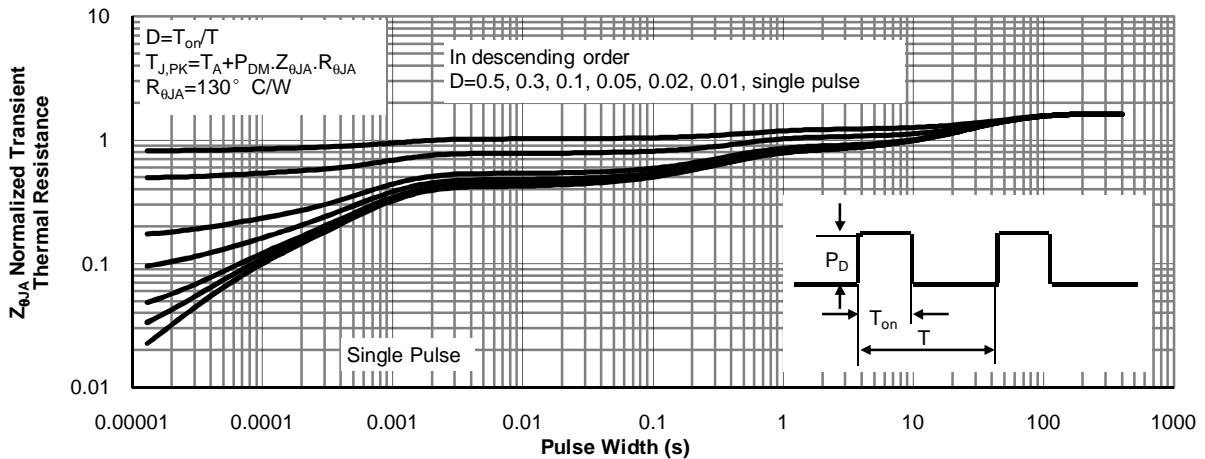
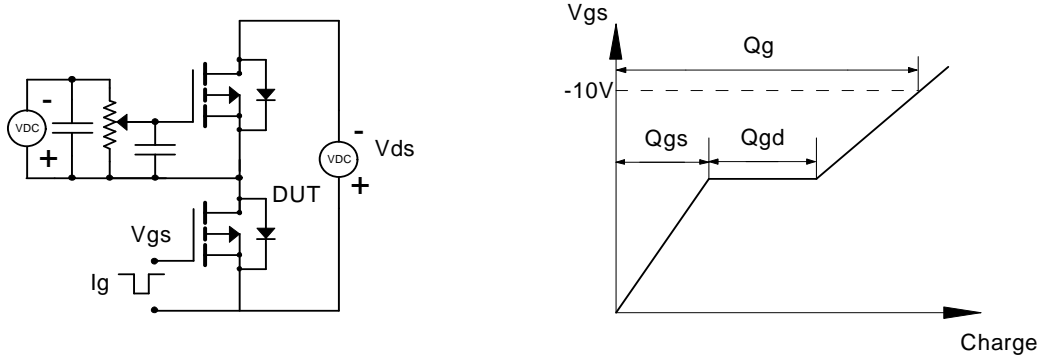
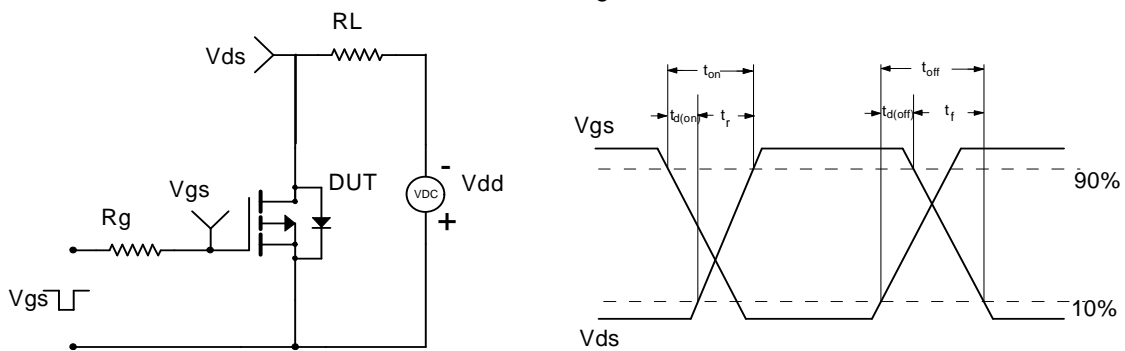

Figure 16: Schottky Normalized Maximum Transient Thermal Impedance

Gate Charge Test Circuit & Waveform



Resistive Switching Test Circuit & Waveforms



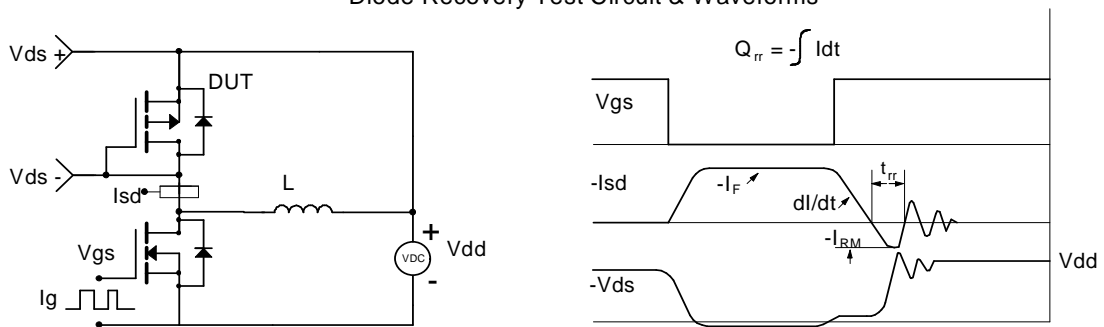

Diode Recovery Test Circuit & Waveforms







Looking for pricing, stock, or lifecycle information?

Click below to explore more details on WIN SOURCE:

-  [View AON4703 on WIN SOURCE](#)
-  [Alpha & Omega Semiconductor Inc. Information](#)

Optimize Your Supply Chain with WIN SOURCE Solutions

-  Global Sourcing Solution
-  Obsolete Management
-  Cost Control Management
-  Shortage Management
-  Alternative Solution
-  Excess Inventory Management