



**THE DATASHEET OF
AON6444L**



General Description

The AON6444L is fabricated with SDMOS™ trench technology that combines excellent $R_{DS(ON)}$ with low gate charge. The result is outstanding efficiency with controlled switching behavior. This universal technology is well suited for PWM, load switching and general purpose applications.

Product Summary

| | |
|------------------------------------|-----------------|
| V_{DS} | 60V |
| I_D (at $V_{GS}=10V$) | 81A |
| $R_{DS(ON)}$ (at $V_{GS}=10V$) | < 6.5m Ω |
| $R_{DS(ON)}$ (at $V_{GS} = 4.5V$) | < 8m Ω |

100% UIS Tested
 100% R_g Tested

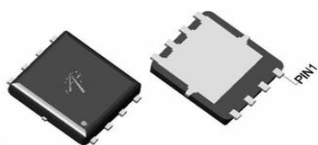

DFN5X6

Top View

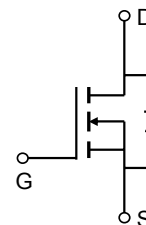
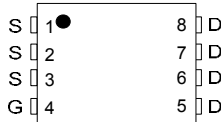

Absolute Maximum Ratings $T_A=25^\circ\text{C}$ unless otherwise noted

| Parameter | Symbol | Maximum | Units |
|---|----------------|-------------------------|------------------|
| Drain-Source Voltage | V_{DS} | 60 | V |
| Gate-Source Voltage | V_{GS} | ± 20 | V |
| Continuous Drain Current | I_D | $T_C=25^\circ\text{C}$ | 81 |
| | | $T_C=100^\circ\text{C}$ | 51 |
| Pulsed Drain Current ^C | I_{DM} | 170 | A |
| Continuous Drain Current | I_{DSM} | $T_A=25^\circ\text{C}$ | 14 |
| | | $T_A=70^\circ\text{C}$ | 11 |
| Avalanche Current ^C | I_{AR} | 58 | A |
| Repetitive avalanche energy $L=0.1\text{mH}$ ^C | E_{AR} | 168 | mJ |
| Power Dissipation ^B | P_D | $T_C=25^\circ\text{C}$ | 83 |
| | | $T_C=100^\circ\text{C}$ | 33 |
| Power Dissipation ^A | P_{DSM} | $T_A=25^\circ\text{C}$ | 2.3 |
| | | $T_A=70^\circ\text{C}$ | 1.4 |
| Junction and Storage Temperature Range | T_J, T_{STG} | -55 to 150 | $^\circ\text{C}$ |

Thermal Characteristics

| Parameter | Symbol | Typ | Max | Units |
|--|-----------------|--------------|-----|--------------------|
| Maximum Junction-to-Ambient ^A | $R_{\theta JA}$ | 14 | 17 | $^\circ\text{C/W}$ |
| Maximum Junction-to-Ambient ^{A D} | | Steady-State | 40 | 55 |
| Maximum Junction-to-Case | $R_{\theta JC}$ | 1 | 1.5 | $^\circ\text{C/W}$ |

Electrical Characteristics (T_J=25°C unless otherwise noted)

| Symbol | Parameter | Conditions | Min | Typ | Max | Units |
|-----------------------------|---------------------------------------|---|------|------------|-------------|-------|
| STATIC PARAMETERS | | | | | | |
| BV _{DSS} | Drain-Source Breakdown Voltage | I _D =250μA, V _{GS} =0V | 60 | | | V |
| I _{DSS} | Zero Gate Voltage Drain Current | V _{DS} =60V, V _{GS} =0V T _J =55°C | | | 100 500 | μA |
| I _{GSS} | Gate-Body leakage current | V _{DS} =0V, V _{GS} = ±20V | | | 100 | nA |
| V _{GS(th)} | Gate Threshold Voltage | V _{DS} =V _{GS} , I _D =250μA | 1.5 | 2 | 2.5 | V |
| I _{D(ON)} | On state drain current | V _{GS} =10V, V _{DS} =5V | 170 | | | A |
| R _{DS(ON)} | Static Drain-Source On-Resistance | V _{GS} =10V, I _D =20A T _J =125°C | | 5.4 9.6 | 6.5 11.5 | mΩ |
| | | V _{GS} =4.5V, I _D =20A | | 6.4 | 8 | mΩ |
| g _{FS} | Forward Transconductance | V _{DS} =5V, I _D =20A | | 75 | | S |
| V _{SD} | Diode Forward Voltage | I _S =1A, V _{GS} =0V | | 0.7 | 1 | V |
| I _S | Maximum Body-Diode Continuous Current | | | | 81 | A |
| DYNAMIC PARAMETERS | | | | | | |
| C _{iss} | Input Capacitance | V _{GS} =0V, V _{DS} =30V, f=1MHz | 3800 | 4800 | 5800 | pF |
| C _{oss} | Output Capacitance | | 330 | 470 | 610 | pF |
| C _{rss} | Reverse Transfer Capacitance | | 110 | 190 | 270 | pF |
| R _g | Gate resistance | V _{GS} =0V, V _{DS} =0V, f=1MHz | 0.5 | 1 | 1.5 | Ω |
| SWITCHING PARAMETERS | | | | | | |
| Q _g (10V) | Total Gate Charge | V _{GS} =10V, V _{DS} =30V, I _D =20A | 64 | 80 | 96 | nC |
| Q _g (4.5V) | Total Gate Charge | | 32 | 40 | 48 | nC |
| Q _{gs} | Gate Source Charge | | 12 | 15 | 18 | nC |
| Q _{gd} | Gate Drain Charge | | 8 | 14 | 20 | nC |
| t _{D(on)} | Turn-On Delay Time | V _{GS} =10V, V _{DS} =30V, R _L =1.5Ω, R _{GEN} =3Ω | | 13.5 | | ns |
| t _r | Turn-On Rise Time | | | 4.2 | | ns |
| t _{D(off)} | Turn-Off Delay Time | | | 51 | | ns |
| t _f | Turn-Off Fall Time | | | 7 | | ns |
| t _{rr} | Body Diode Reverse Recovery Time | I _F =20A, dI/dt=500A/μs | 14 | 18 | 22 | ns |
| Q _{rr} | Body Diode Reverse Recovery Charge | I _F =20A, dI/dt=500A/μs | 43 | 54 | 65 | nC |

A. The value of R_{θJA} is measured with the device mounted on 1in² FR-4 board with 2oz. Copper, in a still air environment with T_A=25°C. The Power dissipation P_{DSM} is based on R_{θJA} and the maximum allowed junction temperature of 150°C. The value in any given application depends on the user's specific board design, and the maximum temperature of 150°C may be used if the PCB allows it.

B. The power dissipation P_D is based on T_{J(MAX)}=150°C, using junction-to-case thermal resistance, and is more useful in setting the upper dissipation limit for cases where additional heatsinking is used.

C. Repetitive rating, pulse width limited by junction temperature T_{J(MAX)}=150°C. Ratings are based on low frequency and duty cycles to keep initial T_J=25°C.

D. The R_{θJA} is the sum of the thermal impedance from junction to case R_{θJC} and case to ambient.

E. The static characteristics in Figures 1 to 6 are obtained using <300μs pulses, duty cycle 0.5% max.

F. These curves are based on the junction-to-case thermal impedance which is measured with the device mounted to a large heatsink, assuming a maximum junction temperature of T_{J(MAX)}=150°C. The SOA curve provides a single pulse rating.

G. These tests are performed with the device mounted on 1 in² FR-4 board with 2oz. Copper, in a still air environment with T_A=25°C.

Rev 0: January 2009

COMPONENTS IN LIFE SUPPORT DEVICES OR SYSTEMS ARE NOT AUTHORIZED. AOS DOES NOT ASSUME ANY LIABILITY ARISING OUT OF SUCH APPLICATIONS OR USES OF ITS PRODUCTS. AOS RESERVES THE RIGHT TO IMPROVE PRODUCT DESIGN, FUNCTIONS AND RELIABILITY WITHOUT NOTICE.

TYPICAL ELECTRICAL AND THERMAL CHARACTERISTICS

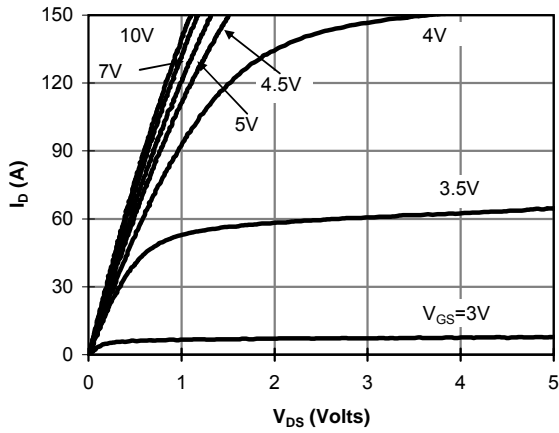

Fig 1: On-Region Characteristics (Note E)

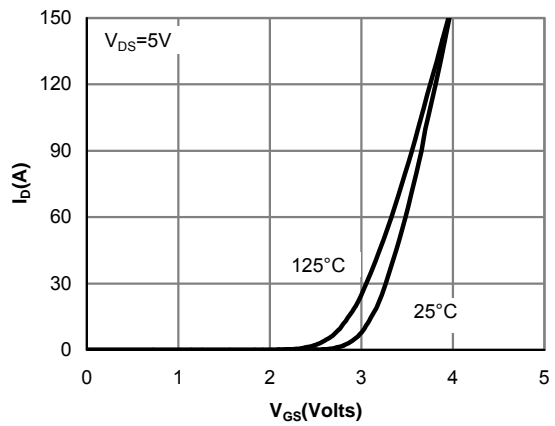

Figure 2: Transfer Characteristics (Note E)

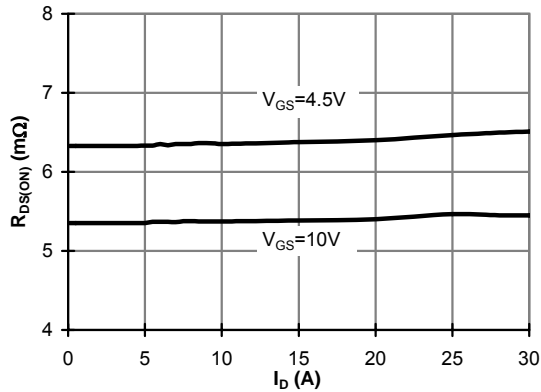

Figure 3: On-Resistance vs. Drain Current and Gate Voltage (Note E)

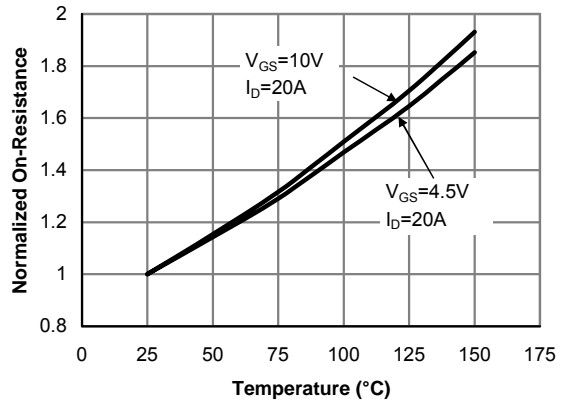

Figure 4: On-Resistance vs. Junction Temperature (Note E)

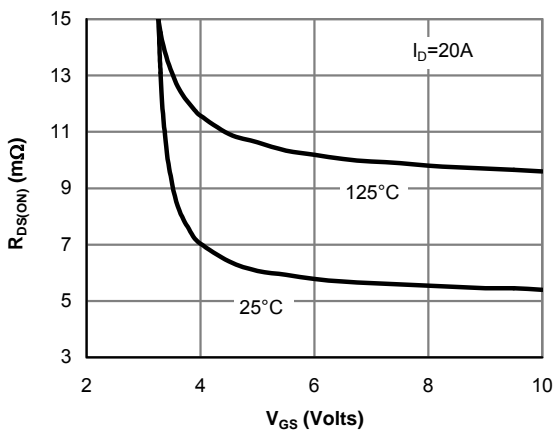

Figure 5: On-Resistance vs. Gate-Source Voltage (Note E)

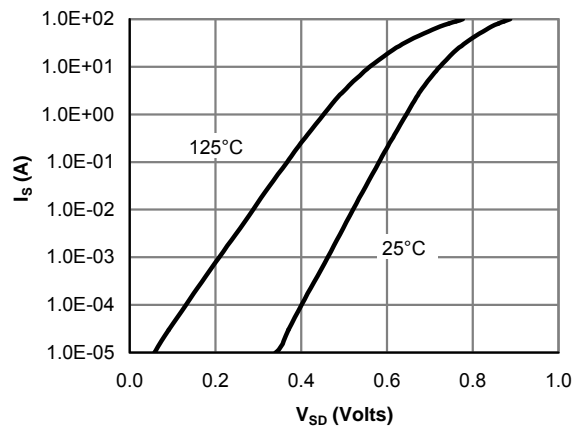

Figure 6: Body-Diode Characteristics (Note E)

TYPICAL ELECTRICAL AND THERMAL CHARACTERISTICS

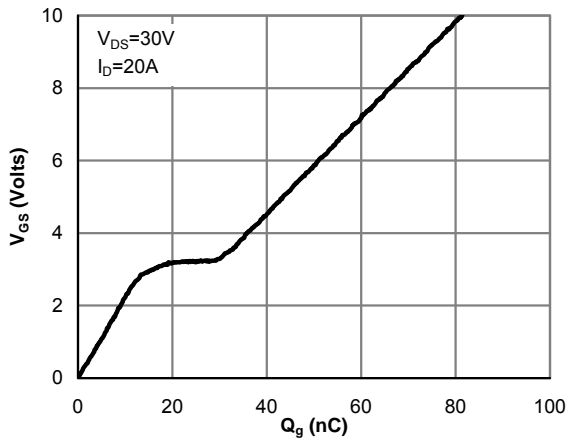

Figure 7: Gate-Charge Characteristics

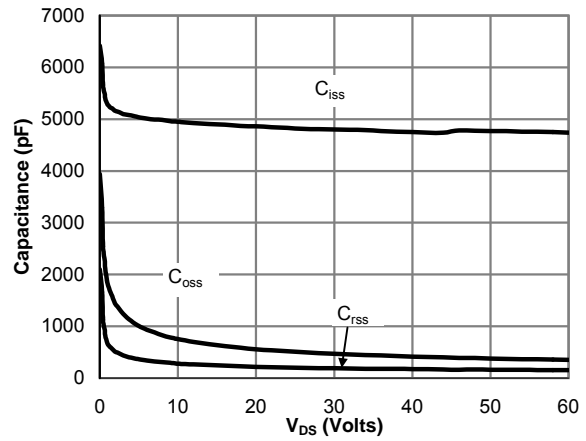

Figure 8: Capacitance Characteristics

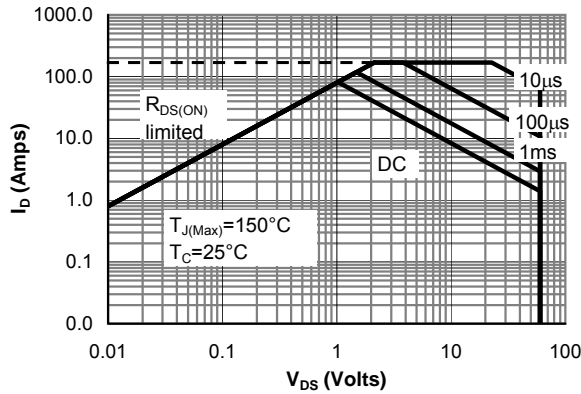

Figure 9: Maximum Forward Biased Safe Operating Area (Note F)

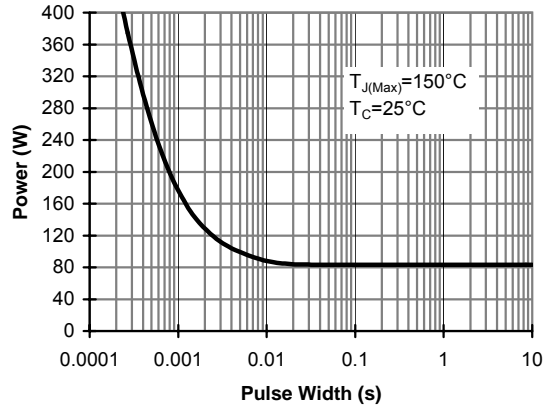

Figure 10: Single Pulse Power Rating Junction-to-Case (Note F)

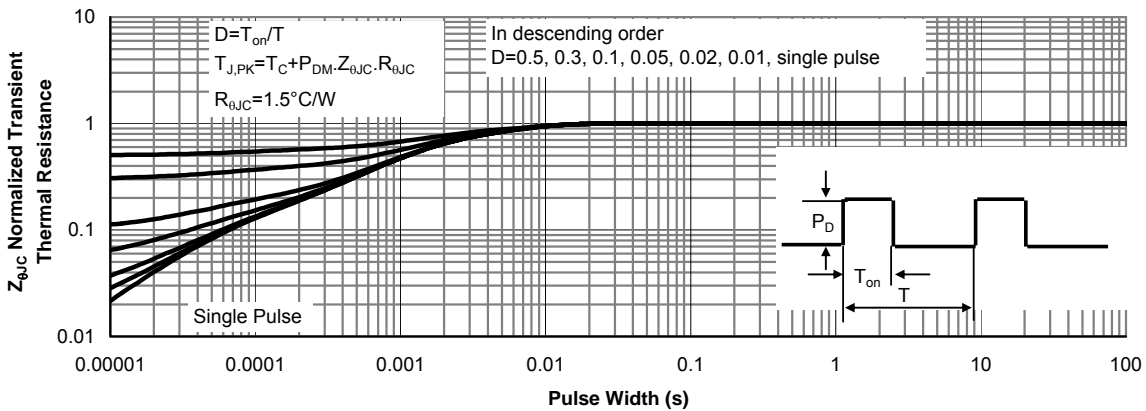

Figure 11: Normalized Maximum Transient Thermal Impedance (Note F)

TYPICAL ELECTRICAL AND THERMAL CHARACTERISTICS

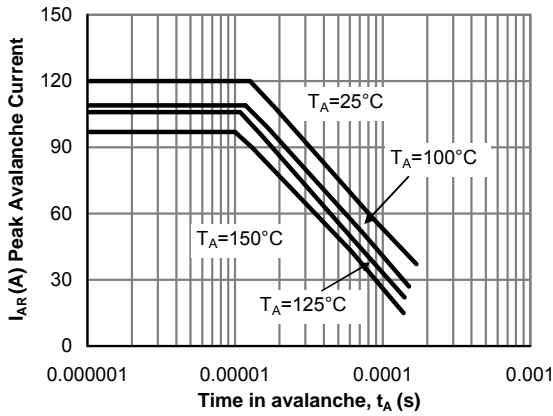

Figure 12: Single Pulse Avalanche capability (Note C)

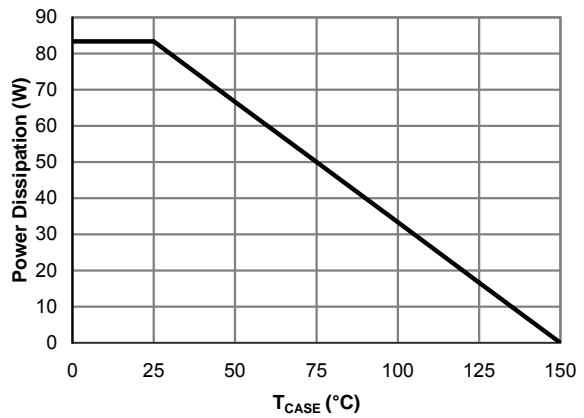

Figure 13: Power De-rating (Note F)

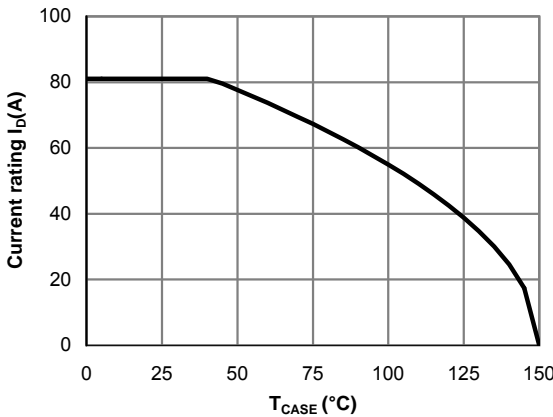

Figure 14: Current De-rating (Note F)

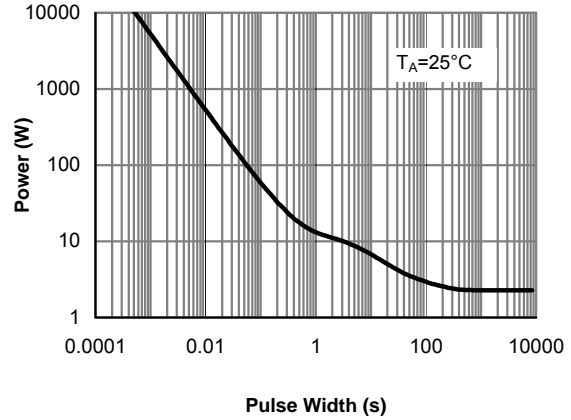

Figure 15: Single Pulse Power Rating Junction-to-Ambient (Note G)

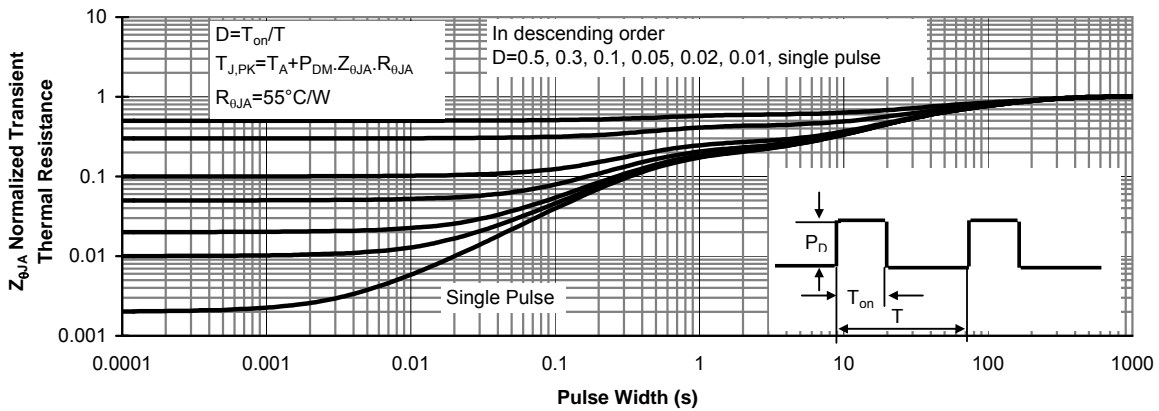

Figure 16: Normalized Maximum Transient Thermal Impedance (Note G)

TYPICAL ELECTRICAL AND THERMAL CHARACTERISTICS

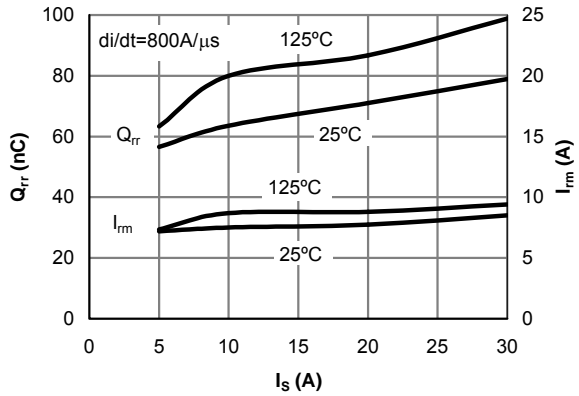

Figure 17: Diode Reverse Recovery Charge and Peak Current vs. Conduction Current

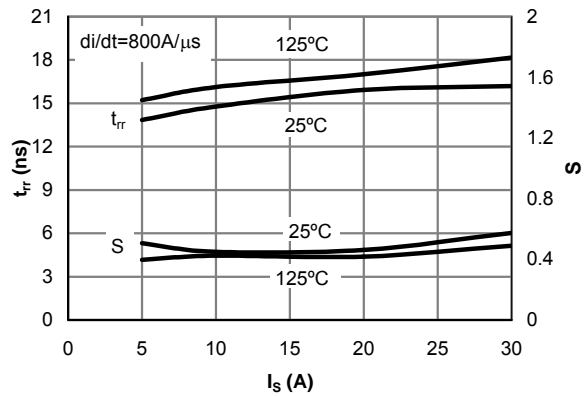

Figure 18: Diode Reverse Recovery Time and Softness Factor vs. Conduction Current

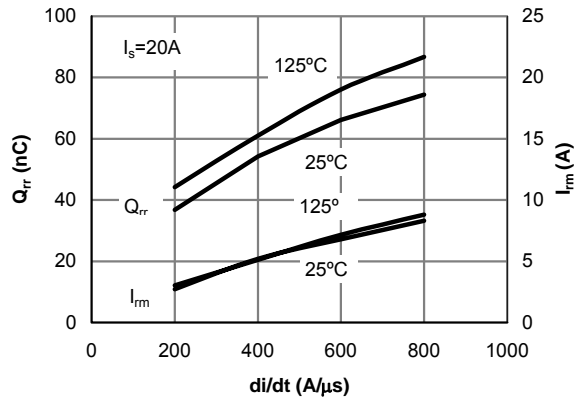

Figure 19: Diode Reverse Recovery Charge and Peak Current vs. di/dt

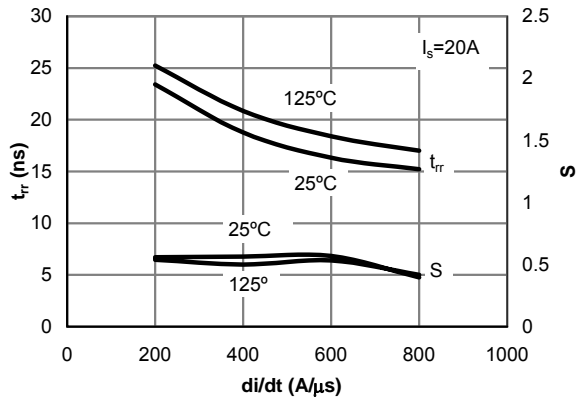
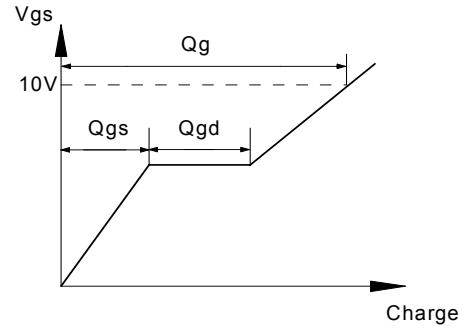
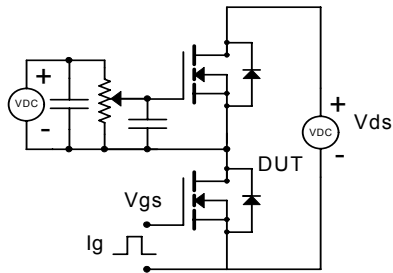
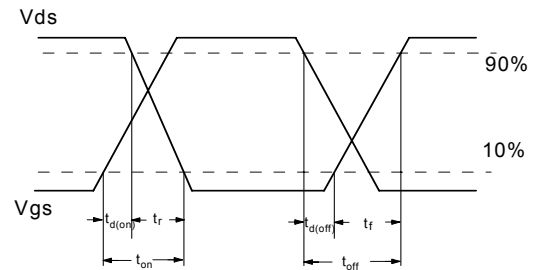
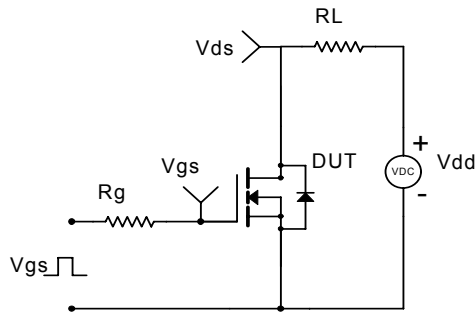

Figure 20: Diode Reverse Recovery Time and Softness Factor vs. di/dt

Gate Charge Test Circuit & Waveform



Resistive Switching Test Circuit & Waveforms



Unclamped Inductive Switching (UIS) Test Circuit & Waveforms

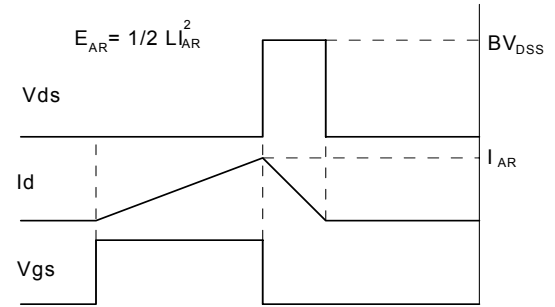
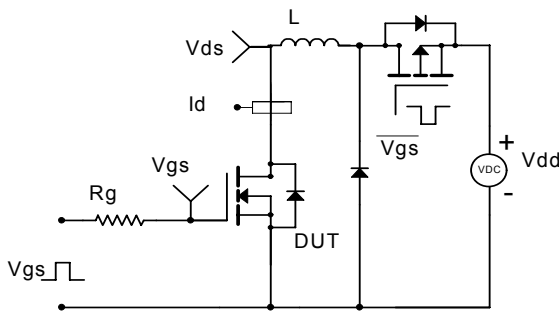

Diode Recovery Test Circuit & Waveforms

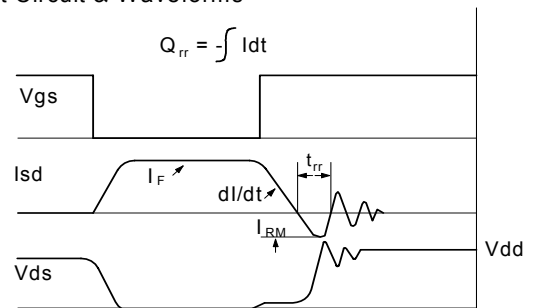
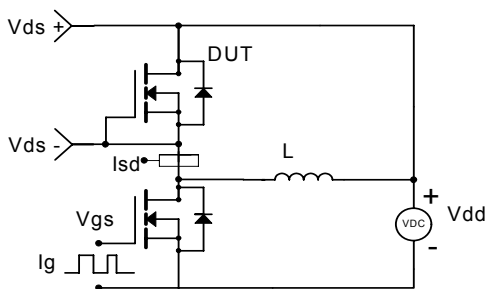

Looking for pricing, stock, or lifecycle information?

Click below to explore more details on WIN SOURCE:

- ⊖ [View AON6444L on WIN SOURCE](#)
- ⊖ [Alpha & Omega Semiconductor Inc. Information](#)

Optimize Your Supply Chain with WIN SOURCE Solutions

- ✓ Global Sourcing Solution
- ✓ Obsolete Management
- ✓ Cost Control Management
- ✓ Shortage Management
- ✓ Alternative Solution
- ✓ Excess Inventory Management