



**THE DATASHEET OF  
AOWF11S65**



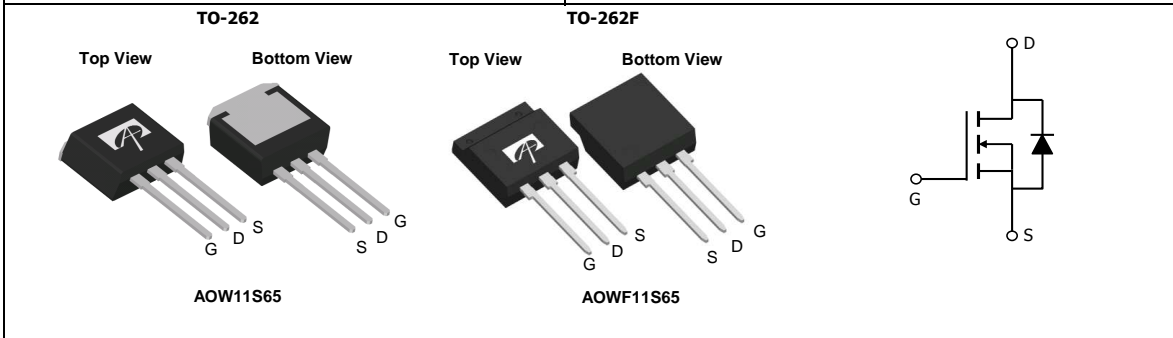
**General Description**

The AOW11S65 & AOWF11S65 have been fabricated using the advanced  $\alpha$ MOS™ high voltage process that is designed to deliver high levels of performance and robustness in switching applications. By providing low  $R_{DS(ON)}$ ,  $Q_g$  and  $E_{OSS}$  along with guaranteed avalanche capability these parts can be adopted quickly into new and existing offline power supply designs.

**Product Summary**

$V_{DS} @ T_{j,max}$	750V
$I_{DM}$	45A
$R_{DS(ON),max}$	0.399 $\Omega$
$Q_{g,typ}$	13.2nC
$E_{oss} @ 400V$	2.9 $\mu$ J

100% UIS Tested  
 100%  $R_g$  Tested


**Absolute Maximum Ratings  $T_A=25^\circ\text{C}$  unless otherwise noted**

Parameter	Symbol	AOW11S65	AOWF11S65	Units
Drain-Source Voltage	$V_{DS}$	650		V
Gate-Source Voltage	$V_{GS}$	$\pm 30$		V
Continuous Drain Current	$I_D$	$T_C=25^\circ\text{C}$	11	11*
		$T_C=100^\circ\text{C}$	8	8*
Pulsed Drain Current <sup>C</sup>	$I_{DM}$	45		A
Avalanche Current <sup>C</sup>	$I_{AR}$	2		A
Repetitive avalanche energy <sup>C</sup>	$E_{AR}$	60		mJ
Single pulsed avalanche energy <sup>G</sup>	$E_{AS}$	120		mJ
Power Dissipation <sup>B</sup>	$P_D$	$T_C=25^\circ\text{C}$	198	28
		Derate above $25^\circ\text{C}$	1.6	0.22
MOSFET dv/dt ruggedness	dv/dt	100		V/ns
Peak diode recovery dv/dt <sup>H</sup>		20		
Junction and Storage Temperature Range	$T_J, T_{STG}$	-55 to 150		$^\circ\text{C}$
Maximum lead temperature for soldering purpose, 1/8" from case for 5 seconds <sup>J</sup>	$T_L$	300		$^\circ\text{C}$

**Thermal Characteristics**

Parameter	Symbol	AOW11S65	AOWF11S65	Units
Maximum Junction-to-Ambient <sup>A,D</sup>	$R_{\theta JA}$	65	65	$^\circ\text{C}/\text{W}$
Maximum Case-to-sink <sup>A</sup>	$R_{\theta CS}$	0.5	--	$^\circ\text{C}/\text{W}$
Maximum Junction-to-Case	$R_{\theta JC}$	0.63	4.5	$^\circ\text{C}/\text{W}$

\* Drain current limited by maximum junction temperature.

**Electrical Characteristics (T<sub>J</sub>=25°C unless otherwise noted)**

Symbol	Parameter	Conditions	Min	Typ	Max	Units
<b>STATIC PARAMETERS</b>						
BV <sub>DSS</sub>	Drain-Source Breakdown Voltage	I <sub>D</sub> =250μA, V <sub>GS</sub> =0V, T <sub>J</sub> =25°C	650	-	-	V
		I <sub>D</sub> =250μA, V <sub>GS</sub> =0V, T <sub>J</sub> =150°C	700	750	-	
I <sub>DSS</sub>	Zero Gate Voltage Drain Current	V <sub>DS</sub> =650V, V <sub>GS</sub> =0V	-	-	1	μA
		V <sub>DS</sub> =520V, T <sub>J</sub> =150°C	-	10	-	
I <sub>GSS</sub>	Gate-Body leakage current	V <sub>DS</sub> =0V, V <sub>GS</sub> =±30V	-	-	±100	nA
V <sub>GS(th)</sub>	Gate Threshold Voltage	V <sub>DS</sub> =5V, I <sub>D</sub> =250μA	2.6	3.3	4	V
R <sub>DS(ON)</sub>	Static Drain-Source On-Resistance	V <sub>GS</sub> =10V, I <sub>D</sub> =5.5A, T <sub>J</sub> =25°C	-	0.35	0.399	Ω
		V <sub>GS</sub> =10V, I <sub>D</sub> =5.5A, T <sub>J</sub> =150°C	-	0.98	1.11	Ω
V <sub>SD</sub>	Diode Forward Voltage	I <sub>S</sub> =5.5A, V <sub>GS</sub> =0V, T <sub>J</sub> =25°C	-	0.82	-	V
I <sub>S</sub>	Maximum Body-Diode Continuous Current		-	-	11	A
I <sub>SM</sub>	Maximum Body-Diode Pulsed Current <sup>C</sup>		-	-	45	A
<b>DYNAMIC PARAMETERS</b>						
C <sub>ISS</sub>	Input Capacitance	V <sub>GS</sub> =0V, V <sub>DS</sub> =100V, f=1MHz	-	646	-	pF
C <sub>OSS</sub>	Output Capacitance		-	42	-	pF
C <sub>o(er)</sub>	Effective output capacitance, energy related <sup>H</sup>	V <sub>GS</sub> =0V, V <sub>DS</sub> =0 to 480V, f=1MHz	-	33	-	pF
C <sub>o(tr)</sub>	Effective output capacitance, time related <sup>I</sup>		-	117	-	pF
C <sub>rss</sub>	Reverse Transfer Capacitance	V <sub>GS</sub> =0V, V <sub>DS</sub> =100V, f=1MHz	-	1.1	-	pF
R <sub>g</sub>	Gate resistance	V <sub>GS</sub> =0V, V <sub>DS</sub> =0V, f=1MHz	-	18	-	Ω
<b>SWITCHING PARAMETERS</b>						
Q <sub>g</sub>	Total Gate Charge	V <sub>GS</sub> =10V, V <sub>DS</sub> =480V, I <sub>D</sub> =5.5A	-	13.2	-	nC
Q <sub>gs</sub>	Gate Source Charge		-	3.2	-	nC
Q <sub>gd</sub>	Gate Drain Charge		-	4.3	-	nC
t <sub>D(on)</sub>	Turn-On Delay Time	V <sub>GS</sub> =10V, V <sub>DS</sub> =400V, I <sub>D</sub> =5.5A, R <sub>G</sub> =25Ω	-	25	-	ns
t <sub>r</sub>	Turn-On Rise Time		-	20	-	ns
t <sub>D(off)</sub>	Turn-Off Delay Time		-	77	-	ns
t <sub>f</sub>	Turn-Off Fall Time		-	19	-	ns
t <sub>rr</sub>	Body Diode Reverse Recovery Time	I <sub>F</sub> =5.5A, di/dt=100A/μs, V <sub>DS</sub> =400V	-	278	-	ns
I <sub>rm</sub>	Peak Reverse Recovery Current	I <sub>F</sub> =5.5A, di/dt=100A/μs, V <sub>DS</sub> =400V	-	22	-	A
Q <sub>rr</sub>	Body Diode Reverse Recovery Charge	I <sub>F</sub> =5.5A, di/dt=100A/μs, V <sub>DS</sub> =400V	-	4.2	-	μC

A. The value of R<sub>θJA</sub> is measured with the device in a still air environment with T<sub>A</sub>=25°C.

B. The power dissipation P<sub>D</sub> is based on T<sub>J(MAX)</sub>=150°C, using junction-to-case thermal resistance, and is more useful in setting the upper dissipation limit for cases where additional heatsinking is used.

C. Repetitive rating, pulse width limited by junction temperature T<sub>J(MAX)</sub>=150°C. Ratings are based on low frequency and duty cycles to keep initial T<sub>J</sub>=25°C.

D. The R<sub>θJA</sub> is the sum of the thermal impedance from junction to case R<sub>θJC</sub> and case to ambient.

E. The static characteristics in Figures 1 to 6 are obtained using <300 μs pulses, duty cycle 0.5% max.

F. These curves are based on the junction-to-case thermal impedance which is measured with the device mounted to a large heatsink, assuming a maximum junction temperature of T<sub>J(MAX)</sub>=150°C. The SOA curve provides a single pulse rating.

G. L=60mH, I<sub>AS</sub>=2A, V<sub>DD</sub>=150V, Starting T<sub>J</sub>=25°C

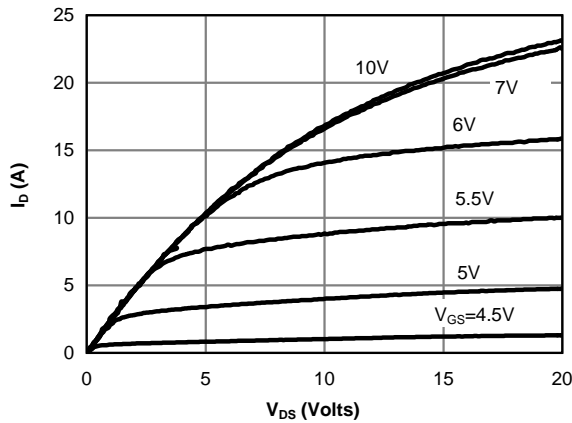
H. C<sub>o(er)</sub> is a fixed capacitance that gives the same stored energy as C<sub>OSS</sub> while V<sub>DS</sub> is rising from 0 to 80% V<sub>(BR)DSS</sub>.

I. C<sub>o(tr)</sub> is a fixed capacitance that gives the same charging time as C<sub>OSS</sub> while V<sub>DS</sub> is rising from 0 to 80% V<sub>(BR)DSS</sub>.

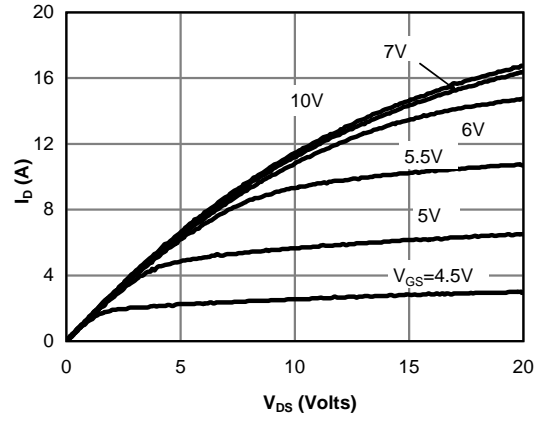
J. Wavesoldering only allowed at leads.

THIS PRODUCT HAS BEEN DESIGNED AND QUALIFIED FOR THE CONSUMER MARKET. APPLICATIONS OR USES AS CRITICAL COMPONENTS IN LIFE SUPPORT DEVICES OR SYSTEMS ARE NOT AUTHORIZED. AOS DOES NOT ASSUME ANY LIABILITY ARISING OUT OF SUCH APPLICATIONS OR USES OF ITS PRODUCTS. AOS RESERVES THE RIGHT TO IMPROVE PRODUCT DESIGN, FUNCTIONS AND RELIABILITY WITHOUT NOTICE.

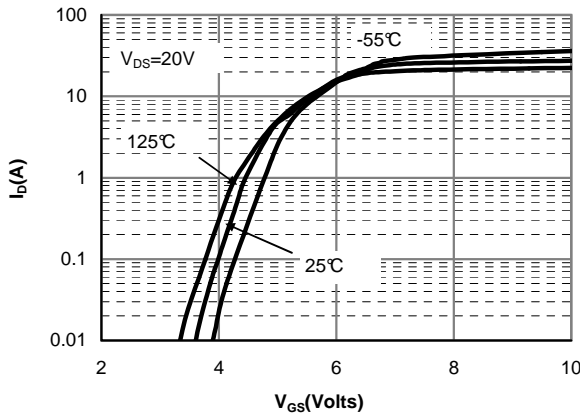
**TYPICAL ELECTRICAL AND THERMAL CHARACTERISTICS**



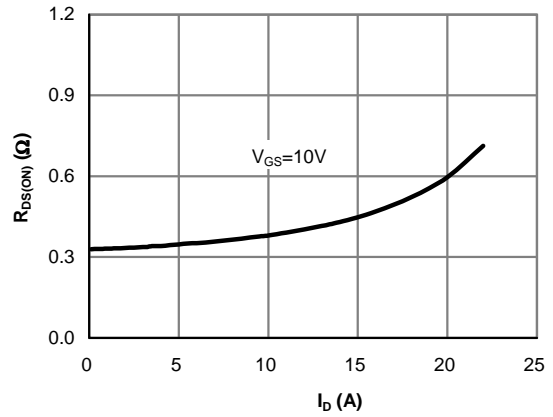
**Figure 1: On-Region Characteristics @ 25°C**



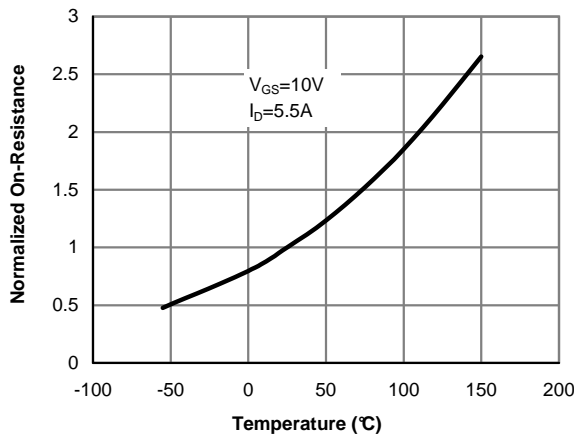
**Figure 2: On-Region Characteristics @ 125°C**



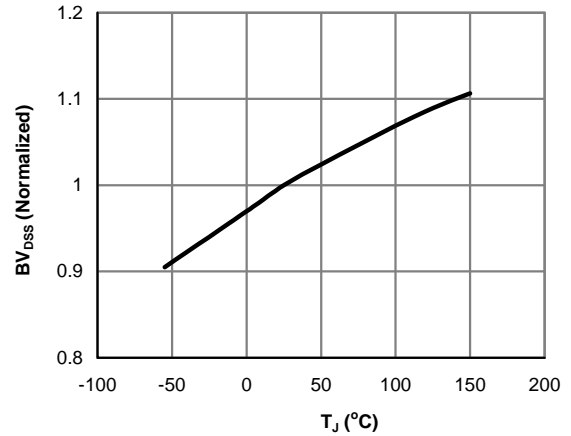
**Figure 3: Transfer Characteristics**



**Figure 4: On-Resistance vs. Drain Current and Gate Voltage**

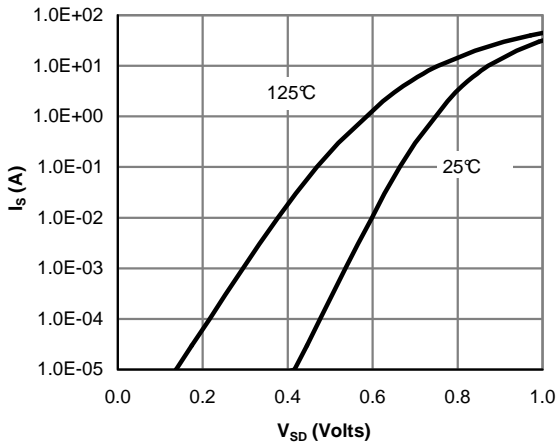


**Figure 5: On-Resistance vs. Junction Temperature**

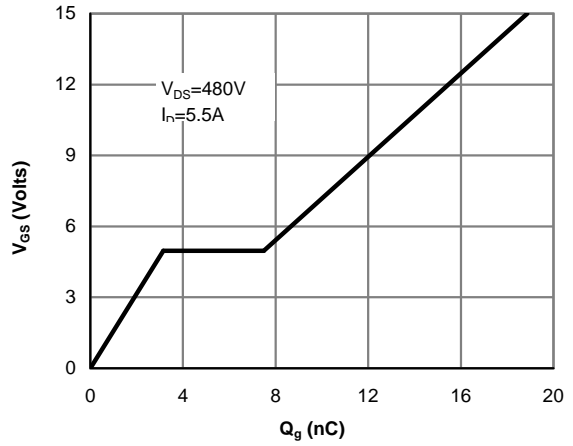


**Figure 6: Break Down vs. Junction Temperature**

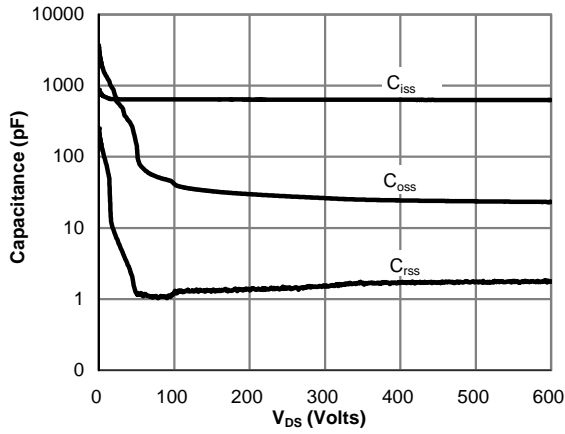
**TYPICAL ELECTRICAL AND THERMAL CHARACTERISTICS**



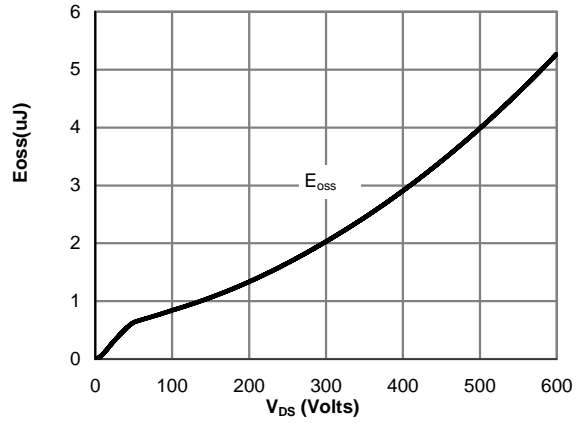
**Figure 7: Body-Diode Characteristics (Note E)**



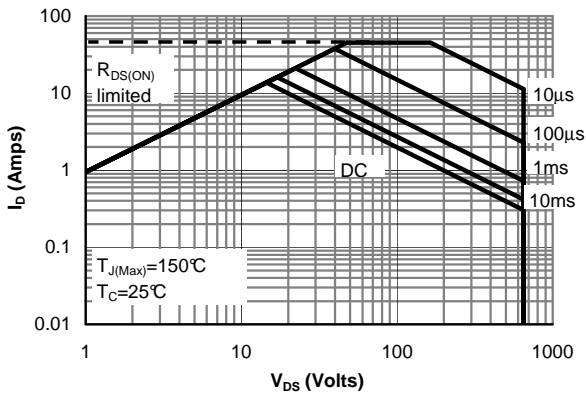
**Figure 8: Gate-Charge Characteristics**



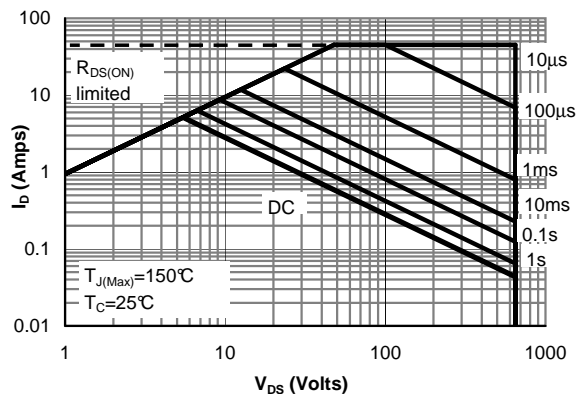
**Figure 9: Capacitance Characteristics**



**Figure 10: Coss stored Energy**

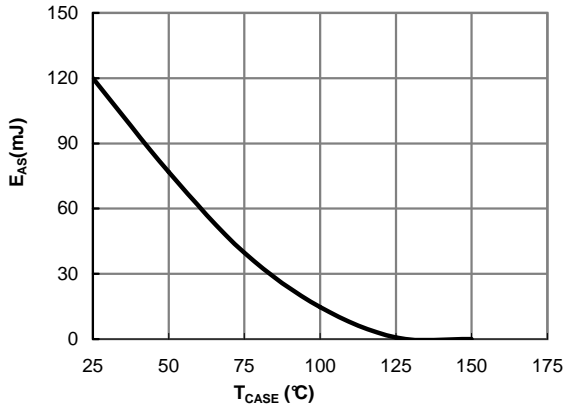


**Figure 11: Maximum Forward Biased Safe Operating Area for AOW11S65 (Note F)**

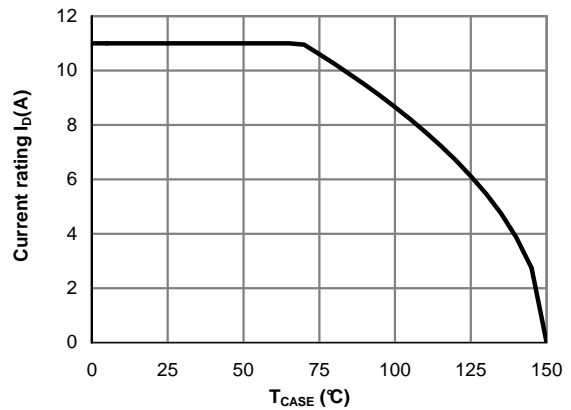


**Figure 12: Maximum Forward Biased Safe Operating Area for AOWF11S65 (Note F)**

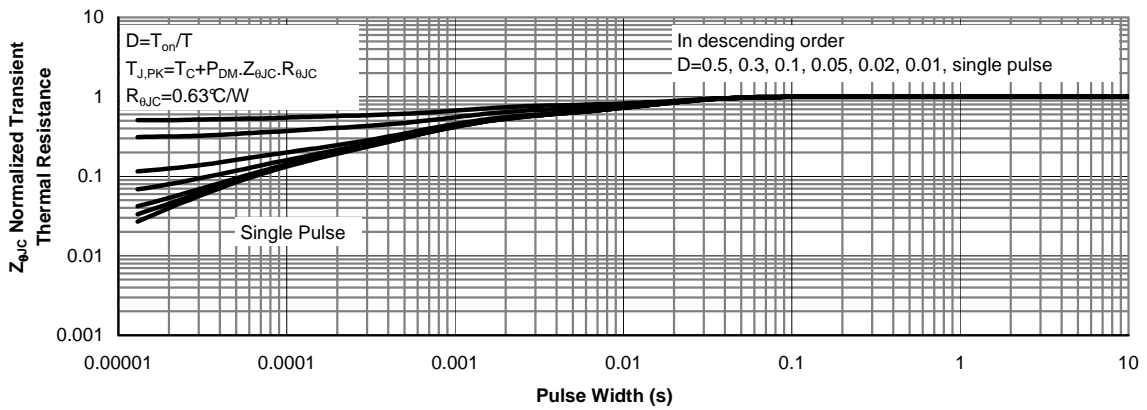
**TYPICAL ELECTRICAL AND THERMAL CHARACTERISTICS**



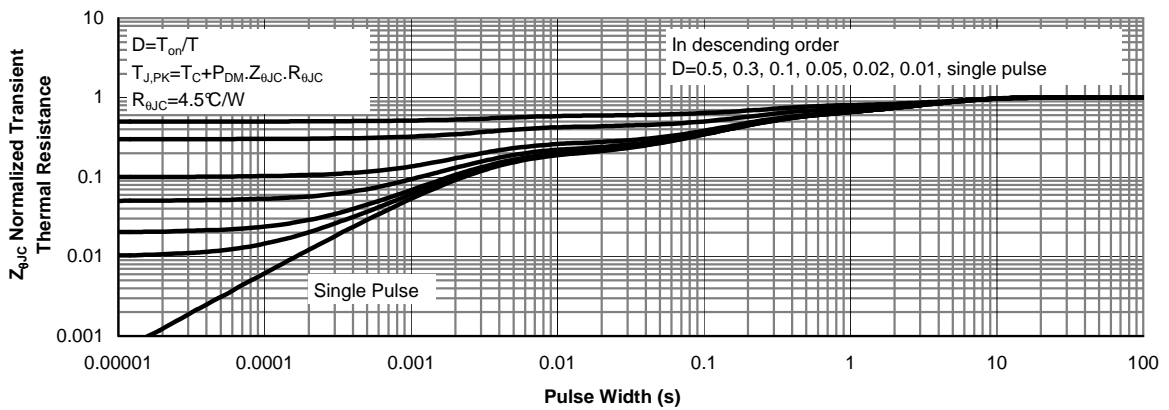
**Figure 13: Avalanche energy**



**Figure 14: Current De-rating (Note B)**

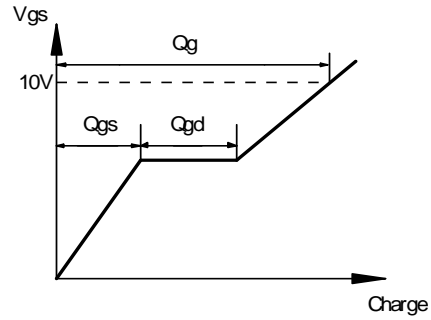
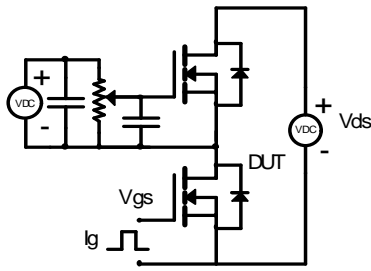


**Figure 15: Normalized Maximum Transient Thermal Impedance for AOW11S65 (Note F)**

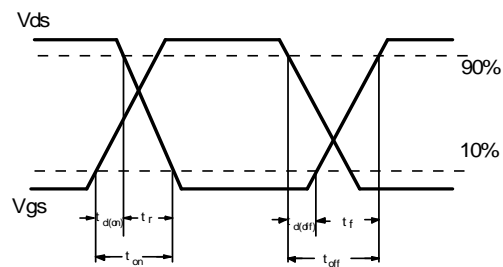
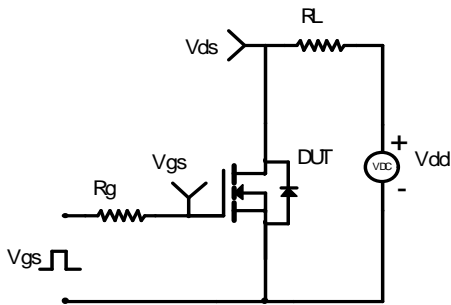


**Figure 16: Normalized Maximum Transient Thermal Impedance for AOWF11S65 (Note F)**

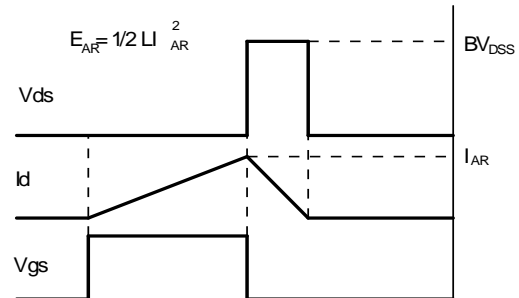
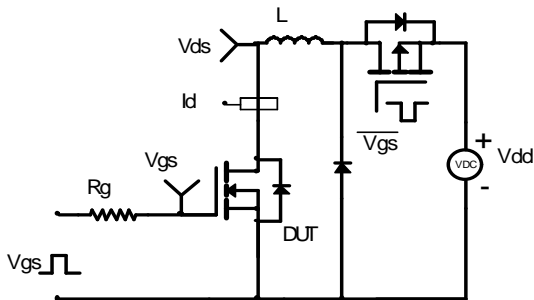
Gate Charge Test Circuit & Waveform



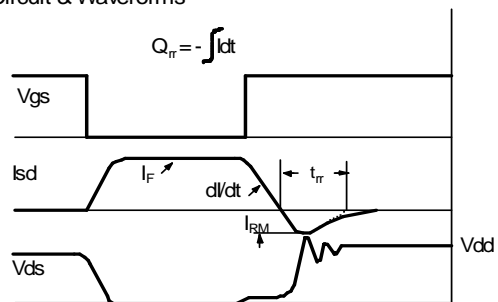
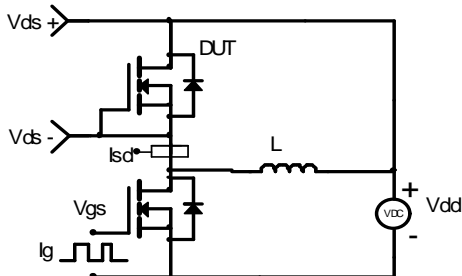
Resistive Switching Test Circuit & Waveforms



Unclamped Inductive Switching (UIS) Test Circuit & Waveforms



Diode Recovery Test Circuit & Waveforms



## Looking for pricing, stock, or lifecycle information?

Click below to explore more details on WIN SOURCE:

- [View AOWF11S65 on WIN SOURCE](#)
- [Alpha & Omega Semiconductor Inc. Information](#)

## Optimize Your Supply Chain with WIN SOURCE Solutions

- ✓ Global Sourcing Solution
- ✓ Obsolete Management
- ✓ Cost Control Management
- ✓ Shortage Management
- ✓ Alternative Solution
- ✓ Excess Inventory Management