



THE DATASHEET OF AOTF404





TO220FL PACKAGE OUTLINE

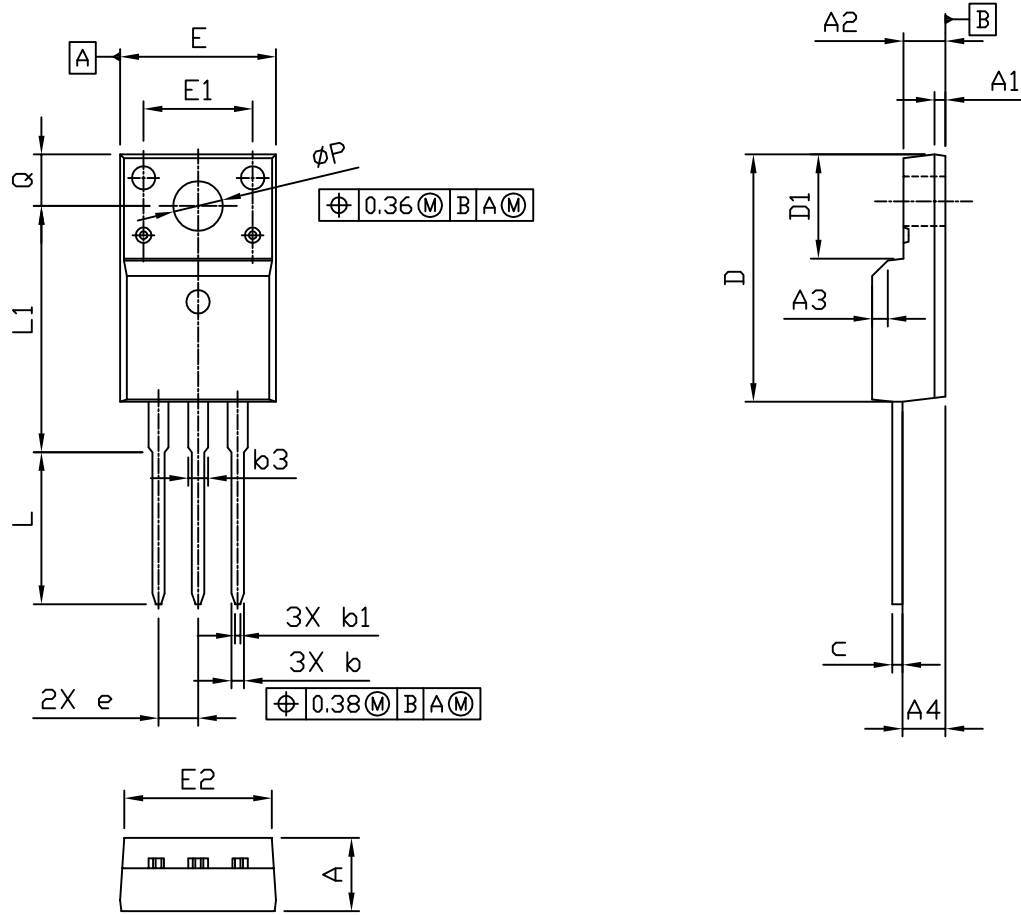

RECOMMENDATION OF HOLE PATTERN

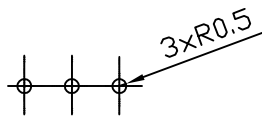

UNIT: mm

SYMBOLS	DIMENSIONS IN MILLIMETERS			DIMENSIONS IN INCHES		
	MIN	NOM	MAX	MIN	NOM	MAX
A	4.50	4.70	4.90	0.177	0.185	0.193
A1	---	0.70	---	---	0.028	---
A2	2.34	2.54	2.74	0.092	0.100	0.108
A3	1X45°			1X45°		
A4	2.56	2.76	2.96	0.101	0.109	0.117
b	0.70	0.80	0.90	0.028	0.031	0.035
b1	0.25	0.35	0.45	0.010	0.014	0.018
b3	1.18	1.28	1.47	0.046	0.050	0.058
c	0.45	0.50	0.60	0.018	0.020	0.024
D	15.67	15.87	16.07	0.617	0.625	0.633
D1	6.48	6.68	6.88	0.255	0.263	0.271
e	2.54 BSC			0.100 BSC.		
E	9.96	10.16	10.36	0.392	0.400	0.408
E1	---	7.00	---	---	0.276	---
E2	9.26	9.46	9.66	0.365	0.372	0.380
L	9.55	9.75	9.95	0.376	0.384	0.392
L1	15.60	15.80	16.00	0.614	0.622	0.630
Q	3.20	3.30	3.40	0.126	0.130	0.134
ØP	3.08	3.18	3.28	0.121	0.125	0.129

NOTE

1. PACKAGE BODY SIZES EXCLUDE MOLD FLASH AND GATE BURRS. MOLD FLASH SHOULD BE LESS THAN 6 MIL.
2. TOLERANCE 0.100 MILLIMETERS UNLESS OTHERWISE SPECIFIED.
3. CONTROLLING DIMENSION IS MILLIMETER. CONVERTED INCH DIMENSIONS ARE NOT NECESSARILY EXACT.

Looking for pricing, stock, or lifecycle information?

Click below to explore more details on WIN SOURCE:

- ⊖ [View AOTF404 on WIN SOURCE](#)
- ⊖ [Alpha & Omega Semiconductor Inc. Information](#)

Optimize Your Supply Chain with WIN SOURCE Solutions

- ✓ Global Sourcing Solution
- ✓ Obsolete Management
- ✓ Cost Control Management
- ✓ Shortage Management
- ✓ Alternative Solution
- ✓ Excess Inventory Management