



THE DATASHEET OF AOTF4N60



General Description

The AOT4N60 & AOTF4N60 & AOTF4N60L have been fabricated using an advanced high voltage MOSFET process that is designed to deliver high levels of performance and robustness in popular AC-DC applications. By providing low $R_{DS(on)}$, C_{iss} and C_{rss} along with guaranteed avalanche capability these parts can be adopted quickly into new and existing offline power supply designs.

Product Summary

V_{DS}	700V@150°C
I_D (at $V_{GS}=10V$)	4A
$R_{DS(on)}$ (at $V_{GS}=10V$)	< 2.2Ω

100% UIS Tested
 100% R_g Tested

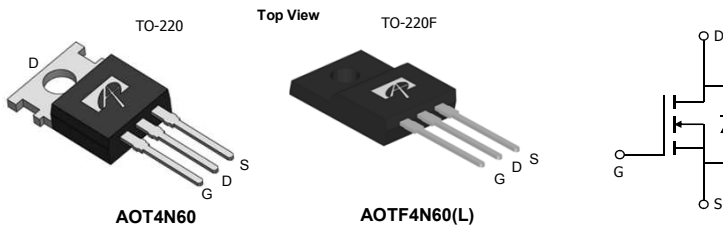

Absolute Maximum Ratings $T_A=25^\circ\text{C}$ unless otherwise noted

Parameter	Symbol	AOT4N60	AOTF4N60	AOTF4N60L	Units	
Drain-Source Voltage	V_{DS}	600			V	
Gate-Source Voltage	V_{GS}	±30			V	
Continuous Drain Current	I_D	$T_C=25^\circ\text{C}$	4	4*	A	
		$T_C=100^\circ\text{C}$	2.7	2.7*		
Pulsed Drain Current ^c	I_{DM}	16				
Avalanche Current ^c	I_{AR}	2.5			A	
Repetitive avalanche energy ^c	E_{AR}	94			mJ	
Single pulsed avalanche energy ^g	E_{AS}	188			mJ	
MOSFET dv/dt ruggedness	dv/dt	50			V/ns	
Peak diode recovery dv/dt		5				
Power Dissipation ^b	P_D	$T_C=25^\circ\text{C}$	104	35	25	W
		Derate above 25°C	0.83	0.28	0.20	W/°C
Junction and Storage Temperature Range	T_J, T_{STG}	-55 to 150			°C	
Maximum lead temperature for soldering purpose, 1/8" from case for 5 seconds	T_L	300			°C	

Thermal Characteristics

Parameter	Symbol	AOT4N60	AOTF4N60	AOTF4N60L	Units
Maximum Junction-to-Ambient ^{A,D}	$R_{\theta JA}$	65	65	65	°C/W
Maximum Case-to-sink ^A	$R_{\theta CS}$	0.5	--	--	°C/W
Maximum Junction-to-Case	$R_{\theta JC}$	1.2	3.6	5	°C/W

* Drain current limited by maximum junction temperature.

Electrical Characteristics (T_J=25°C unless otherwise noted)

Symbol	Parameter	Conditions	Min	Typ	Max	Units
STATIC PARAMETERS						
BV _{DSS}	Drain-Source Breakdown Voltage	I _D =250μA, V _{GS} =0V, T _J =25°C	600			V
		I _D =250μA, V _{GS} =0V, T _J =150°C		700		
BV _{DSS} /ΔT _J	Breakdown Voltage Temperature Coefficient	I _D =250μA, V _{GS} =0V		0.69		V/°C
I _{DSS}	Zero Gate Voltage Drain Current	V _{DS} =600V, V _{GS} =0V			1	μA
		V _{DS} =480V, T _J =125°C			10	
I _{GSS}	Gate-Body leakage current	V _{DS} =0V, V _{GS} =±30V			±100	nA
V _{GS(th)}	Gate Threshold Voltage	V _{DS} =5V, I _D =250μA	3	4	4.5	V
R _{DS(ON)}	Static Drain-Source On-Resistance	V _{GS} =10V, I _D =2A		1.9	2.2	Ω
g _{FS}	Forward Transconductance	V _{DS} =40V, I _D =2A		7.4		S
V _{SD}	Diode Forward Voltage	I _S =1A, V _{GS} =0V		0.77	1	V
I _S	Maximum Body-Diode Continuous Current				4	A
I _{SM}	Maximum Body-Diode Pulsed Current				16	A
DYNAMIC PARAMETERS						
C _{iss}	Input Capacitance	V _{GS} =0V, V _{DS} =25V, f=1MHz	400	511	615	pF
C _{oss}	Output Capacitance		40	51	65	pF
C _{rss}	Reverse Transfer Capacitance		3.5	4.4	5.3	pF
R _g	Gate resistance	V _{GS} =0V, V _{DS} =0V, f=1MHz	3.3	4.2	6.3	Ω
SWITCHING PARAMETERS						
Q _g	Total Gate Charge	V _{GS} =10V, V _{DS} =480V, I _D =4A		15	18	nC
Q _{gs}	Gate Source Charge		3	3.6	nC	
Q _{gd}	Gate Drain Charge		7.6	9.1	nC	
t _{D(on)}	Turn-On Delay Time	V _{GS} =10V, V _{DS} =300V, I _D =4A, R _G =25Ω		20.2	30	ns
t _r	Turn-On Rise Time		28.7	42	ns	
t _{D(off)}	Turn-Off Delay Time		36	51	ns	
t _f	Turn-Off Fall Time		27	40	ns	
t _{rr}	Body Diode Reverse Recovery Time	I _F =4A, dI/dt=100A/μs, V _{DS} =100V		212	254	ns
Q _{rr}	Body Diode Reverse Recovery Charge	I _F =4A, dI/dt=100A/μs, V _{DS} =100V		1.6	1.9	μC

A. The value of R_{θJA} is measured with the device in a still air environment with T_A=25°C.

B. The power dissipation P_D is based on T_{J(MAX)}=150°C, using junction-to-case thermal resistance, and is more useful in setting the upper dissipation limit for cases where additional heatsinking is used.

C. Repetitive rating, pulse width limited by junction temperature T_{J(MAX)}=150°C, Ratings are based on low frequency and duty cycles to keep initial T_J=25°C.

D. The R_{θJA} is the sum of the thermal impedance from junction to case R_{θJC} and case to ambient.

E. The static characteristics in Figures 1 to 6 are obtained using <300 μs pulses, duty cycle 0.5% max.

F. These curves are based on the junction-to-case thermal impedance which is measured with the device mounted to a large heatsink, assuming a maximum junction temperature of T_{J(MAX)}=150°C. The SOA curve provides a single pulse rating.

G. L=60mH, I_{AS}=2.5A, V_{DD}=150V, R_G=25Ω, Starting T_J=25°C

THIS PRODUCT HAS BEEN DESIGNED AND QUALIFIED FOR THE CONSUMER MARKET. APPLICATIONS OR USES AS CRITICAL COMPONENTS IN LIFE SUPPORT DEVICES OR SYSTEMS ARE NOT AUTHORIZED. AOS DOES NOT ASSUME ANY LIABILITY ARISING OUT OF SUCH APPLICATIONS OR USES OF ITS PRODUCTS. AOS RESERVES THE RIGHT TO IMPROVE PRODUCT DESIGN, FUNCTIONS AND RELIABILITY WITHOUT NOTICE.

TYPICAL ELECTRICAL AND THERMAL CHARACTERISTICS

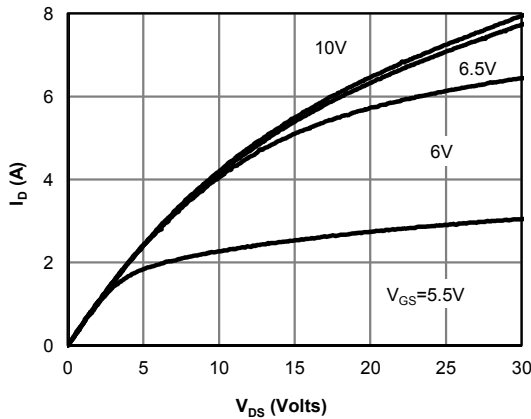

Fig 1: On-Region Characteristics

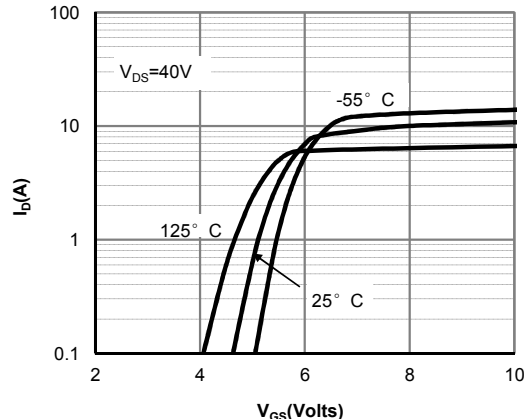

Figure 2: Transfer Characteristics

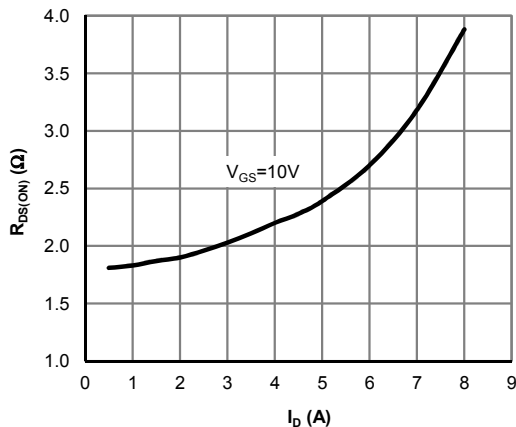

Figure 3: On-Resistance vs. Drain Current and Gate Voltage

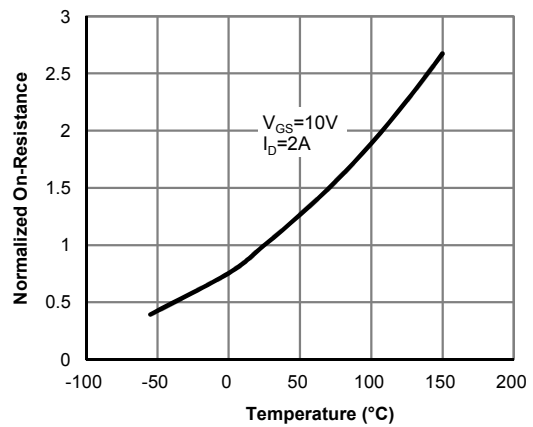

Figure 4: On-Resistance vs. Junction Temperature

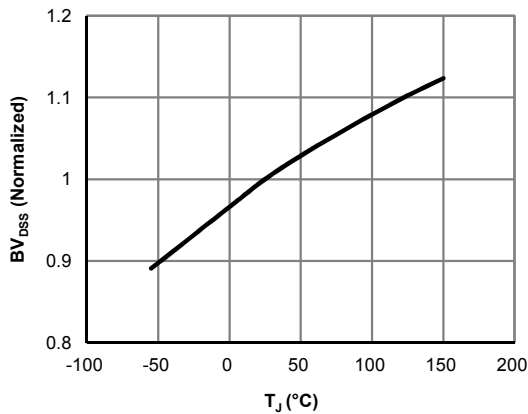

Figure 5: Break Down vs. Junction Temperature

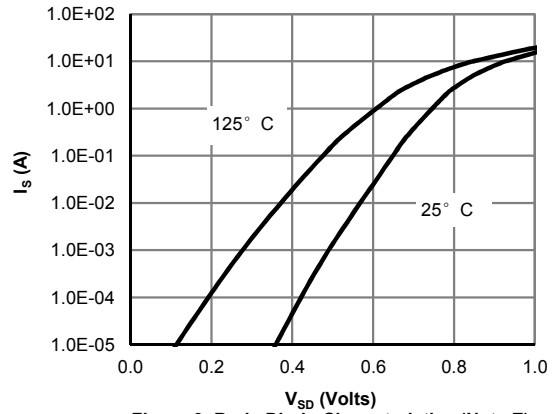

Figure 6: Body-Diode Characteristics (Note E)

TYPICAL ELECTRICAL AND THERMAL CHARACTERISTICS

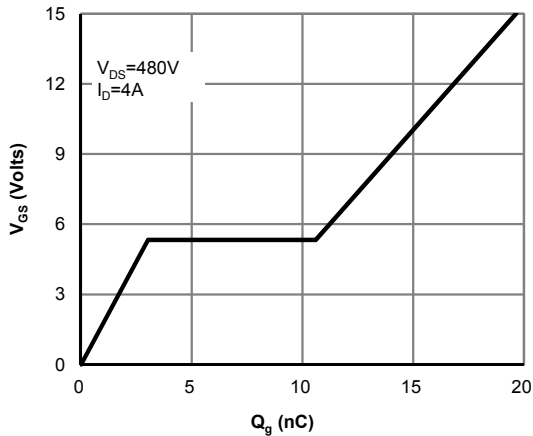

Figure 7: Gate-Charge Characteristics

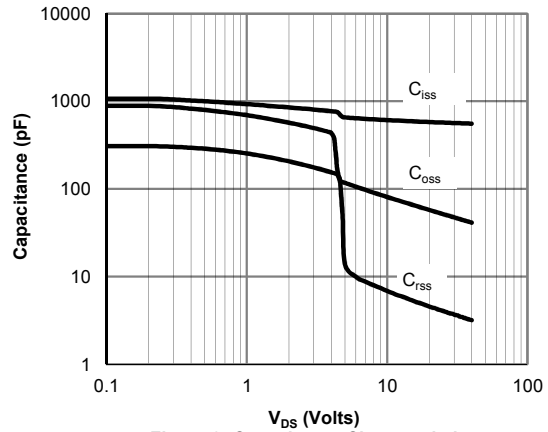

Figure 8: Capacitance Characteristics

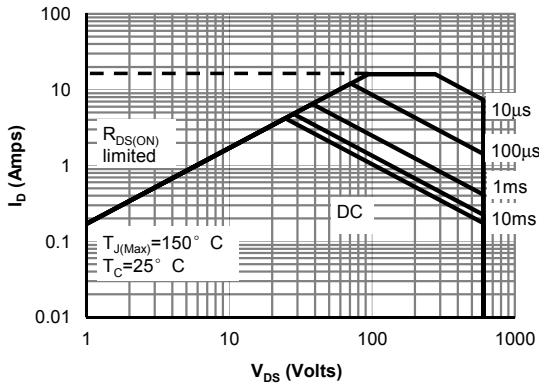

Figure 9: Maximum Forward Biased Safe Operating Area for AOT4N60 (Note F)

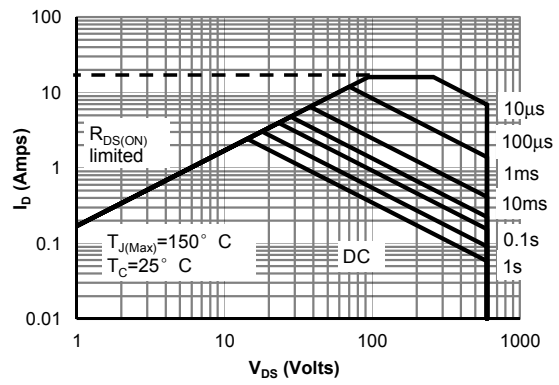

Figure 10: Maximum Forward Biased Safe Operating Area for AOTF4N60 (Note F)

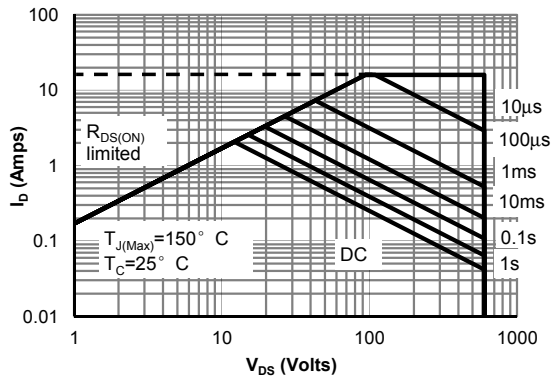

Figure 11: Maximum Forward Biased Safe Operating Area for AOTF4N60L (Note F)

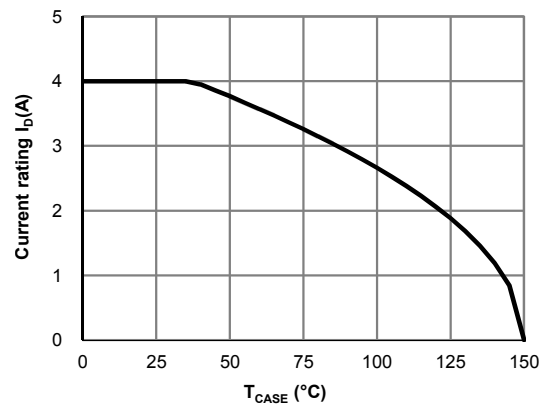

Figure 12: Current De-rating (Note B)

TYPICAL ELECTRICAL AND THERMAL CHARACTERISTICS

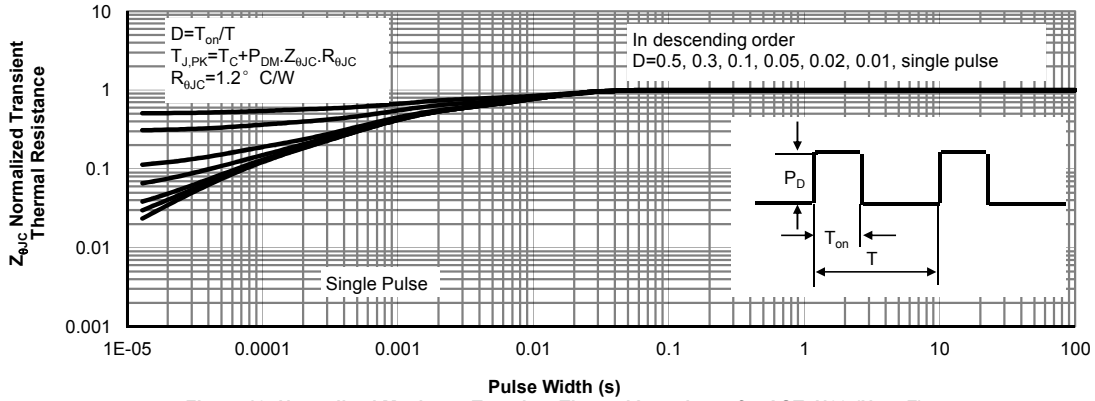

Figure 13: Normalized Maximum Transient Thermal Impedance for AOT4N60 (Note F)

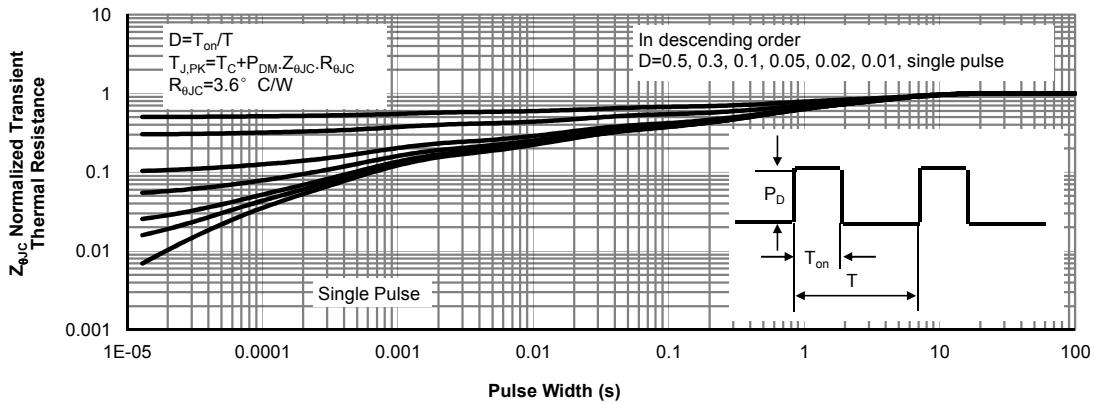

Figure 14: Normalized Maximum Transient Thermal Impedance for AOTF4N60 (Note F)

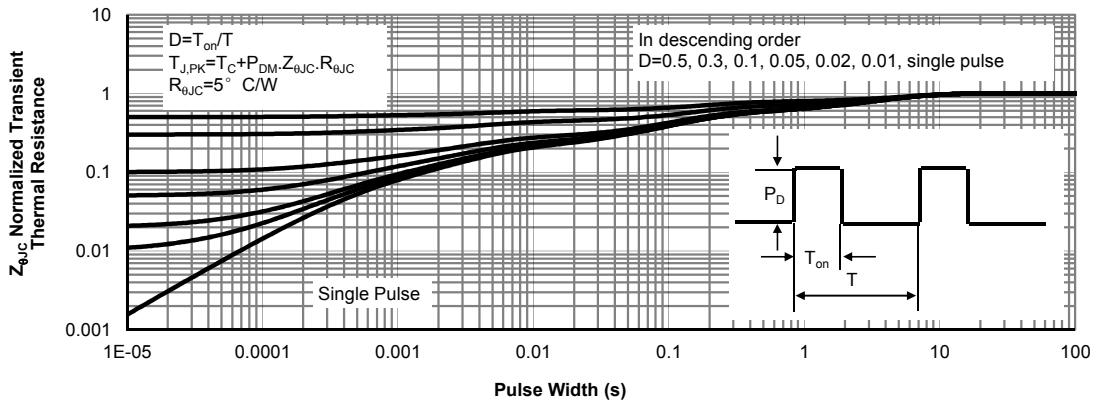
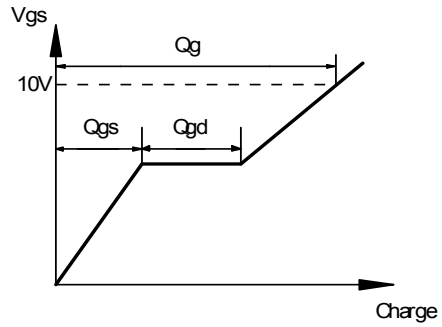
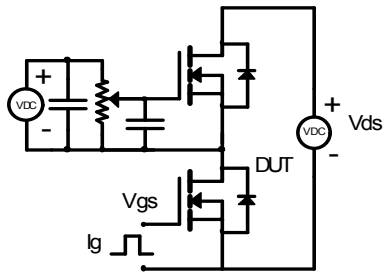
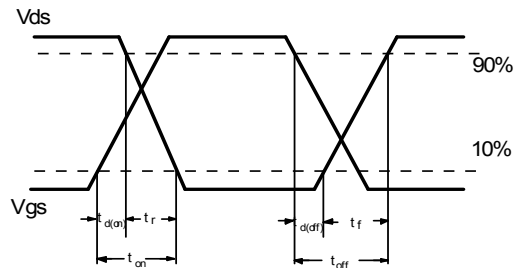
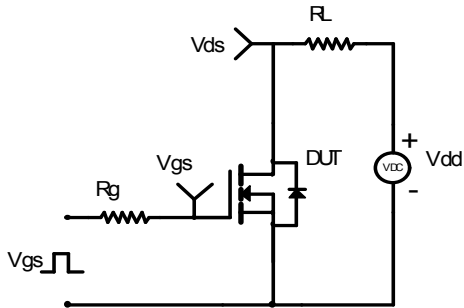

Figure 15: Normalized Maximum Transient Thermal Impedance for AOTF4N60L (Note F)

Gate Charge Test Circuit & Waveform



Resistive Switching Test Circuit & Waveforms



Unclamped Inductive Switching (UIS) Test Circuit & Waveforms

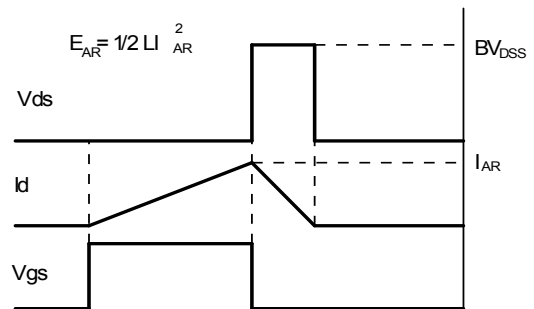
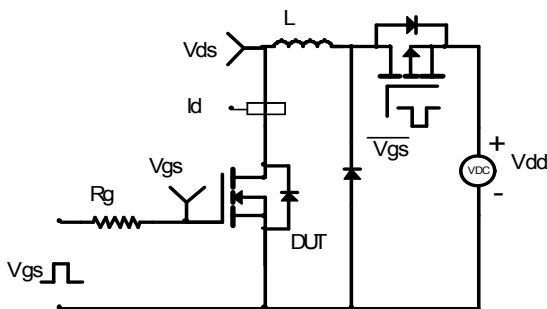

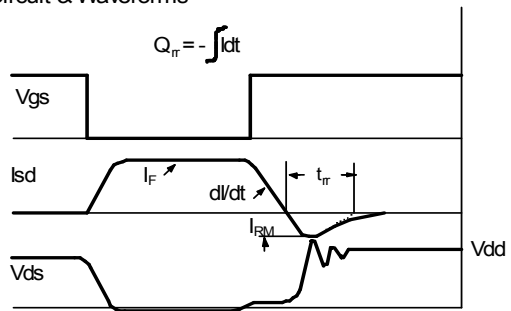
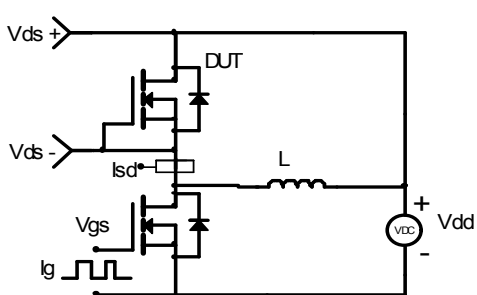

Diode Recovery Test Circuit & Waveforms



Looking for pricing, stock, or lifecycle information?

Click below to explore more details on WIN SOURCE:

-  [View AOTF4N60 on WIN SOURCE](#)
-  [Alpha & Omega Semiconductor Inc. Information](#)

Optimize Your Supply Chain with WIN SOURCE Solutions

-  Global Sourcing Solution
-  Obsolete Management
-  Cost Control Management
-  Shortage Management
-  Alternative Solution
-  Excess Inventory Management