



# THE DATASHEET OF H11G3S



**H11G1  
H11G2  
H11G3**

## DESCRIPTION

The H11GX series are photodarlington-type optically coupled optocouplers. These devices have a gallium arsenide infrared emitting diode coupled with a silicon darlington connected phototransistor which has an integral base-emitter resistor to optimize elevated temperature characteristics.

## FEATURES

- High  $BV_{CEO}$ 
  - Minimum 100 V for H11G1
  - Minimum 80 V for H11G2
  - Minimum 55 V for H11G3
- High sensitivity to low input current  
Minimum 500 percent CTR at  $I_F = 1$  mA
- Low leakage current at elevated temperature  
(maximum 100  $\mu$ A at 80°C)
- Underwriters Laboratory (UL) recognized File# E90700

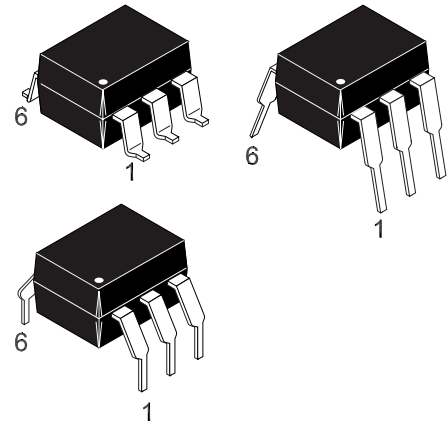

## APPLICATIONS

- CMOS logic interface
- Telephone ring detector
- Low input TTL interface
- Power supply isolation
- Replace pulse transformer

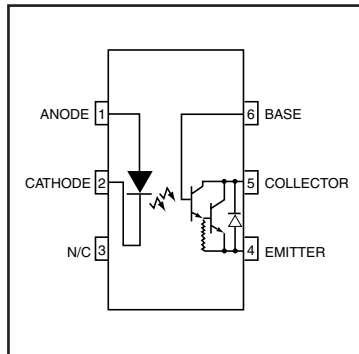

### NOTE

All dimensions are in inches (millimeters)

<b>ABSOLUTE MAXIMUM RATINGS</b>			
Parameter	Symbol	Value	Units
<b>TOTAL DEVICE</b>			
Storage Temperature	$T_{STG}$	-55 to +150	°C
Operating Temperature	$T_{OPR}$	-55 to +100	°C
Lead Solder Temperature	$T_{SOL}$	260 for 10 sec	°C
Total Device Power Dissipation @ $T_A = 25^\circ\text{C}$	$P_D$	260	mW
Derate above 25°C		3.5	mW/°C
Input-Output Isolation Voltage	$V_{ISO}$	5300	Vac(rms)
<b>EMITTER</b>			
Forward Input Current	$I_F$	60	mA
Reverse Input Voltage	$V_R$	6.0	V
Forward Current - Peak (1 $\mu$ s pulse, 300pps)	$I_{F(pk)}$	3.0	A
LED Power Dissipation @ $T_A = 25^\circ\text{C}$	$P_D$	100	mW
Derate above 25°C		1.8	mW/°C
<b>DETECTOR</b>			
Collector-Emitter Voltage	$V_{CEO}$	100	V
H11G1			
H11G2			
H11G3	55		
Detector Power Dissipation @ $T_A = 25^\circ\text{C}$	$P_D$	200	mW
Derate above 25°C		2.67	mW/°C

**H11G1, H11G2, H11G3**
**ELECTRICAL CHARACTERISTICS** ( $T_A = 25^\circ\text{C}$  Unless otherwise specified.)

**INDIVIDUAL COMPONENT CHARACTERISTICS**

Characteristic	Test Conditions	Symbol	Device	Min	Typ**	Max	Unit
<b>EMITTER</b>							
Forward Voltage	( $I_F = 10\text{ mA}$ )	$V_F$	ALL		1.3	1.50	V
Forward Voltage Temp. Coefficient		$\frac{\Delta V_F}{\Delta T_A}$	ALL		-1.8		mV/°C
Reverse Breakdown Voltage	( $I_R = 10\text{ }\mu\text{A}$ )	$BV_R$	ALL	3.0	25		V
Junction Capacitance	( $V_F = 0\text{ V}, f = 1\text{ MHz}$ )	$C_J$	ALL		50		pF
	( $V_F = 1\text{ V}, f = 1\text{ MHz}$ )		ALL		65		pF
Reverse Leakage Current	( $V_R = 3.0\text{ V}$ )	$I_R$	ALL		0.001	10	$\mu\text{A}$
<b>DETECTOR</b>							
Breakdown Voltage Collector to Emitter	( $I_C = 1.0\text{ mA}, I_F = 0$ )	$BV_{CEO}$	H11G1	100			V
			H11G2	80			
			H11G3	55			
Collector to Base	( $I_C = 100\text{ }\mu\text{A}$ )	$BV_{CBO}$	H11G1	100			
			H11G2	80			
			H11G3	55			
Emitter to Base		$BV_{EBO}$	ALL	7	10		
Leakage Current Collector to Emitter	( $V_{CE} = 80\text{ V}, I_F = 0$ )	$I_{CEO}$	H11G1			100	nA
	( $V_{CE} = 60\text{ V}, I_F = 0$ )		H11G2				
	( $V_{CE} = 30\text{ V}, I_F = 0$ )		H11G3				
	( $V_{CE} = 80\text{ V}, I_F = 0, T_A = 80^\circ\text{C}$ )		H11G1			100	$\mu\text{A}$
	( $V_{CE} = 60\text{ V}, I_F = 0, T_A = 80^\circ\text{C}$ )		H11G2				

**TRANSFER CHARACTERISTICS**

DC Characteristic	Test Conditions	Symbol	Device	Min	Typ**	Max	Unit
<b>EMITTER</b>							
Current Transfer Ratio Collector to Emitter	( $I_F = 10\text{ mA}, V_{CE} = 1\text{ V}$ )	CTR	H11G1/2	100 (1000)			mA (%)
	( $I_F = 1\text{ mA}, V_{CE} = 5\text{ V}$ )		H11G1/2	5 (500)			
			H11G3	2 (200)			
Saturation Voltage	( $I_F = 16\text{ mA}, I_C = 50\text{ mA}$ )	$V_{CE(SAT)}$	H11G1/2		0.85	1.0	V
	( $I_F = 1\text{ mA}, I_C = 1\text{ mA}$ )		H11G1/2		0.75	1.0	
	( $I_F = 20\text{ mA}, I_C = 50\text{ mA}$ )		H11G3		0.85	1.2	

**TRANSFER CHARACTERISTICS**

Characteristic	Test Conditions	Symbol	Device	Min	Typ**	Max	Unit
<b>SWITCHING TIMES</b>							
Turn-on Time	( $R_L = 100\text{ }\Omega, I_F = 10\text{ mA}$ )	$t_{on}$	ALL		5		$\mu\text{s}$
Turn-off Time	( $V_{CE} = 5\text{ V}$ ) Pulse Width $\leq 300\text{ }\mu\text{s}, f \leq 30\text{ Hz}$ )	$t_{off}$	ALL		100		

\*\* All typical values at  $T_A = 25^\circ\text{C}$

**H11G1, H11G2, H11G3**

**Fig. 1 Output Current vs. Input Current**

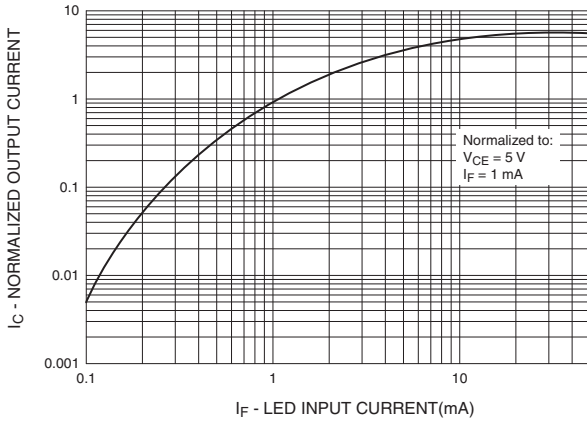

**Fig. 2 Normalized Output Current vs. Temperature**

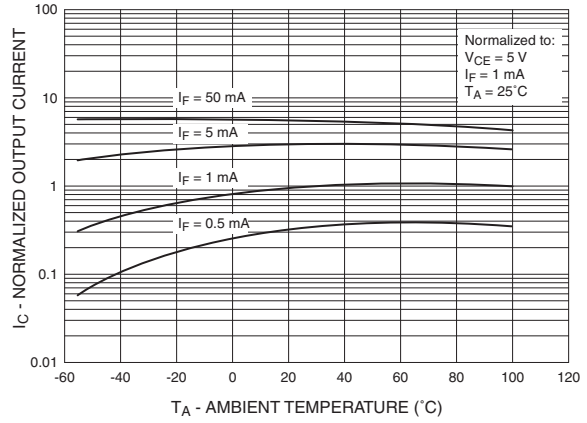

**Fig. 3 Output Current vs. Collector - Emitter Voltage**

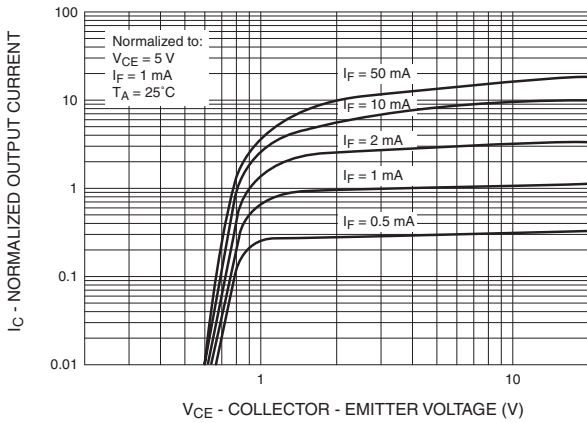

**Fig. 4 Collector-Emitter Dark Current vs. Ambient Temperature**

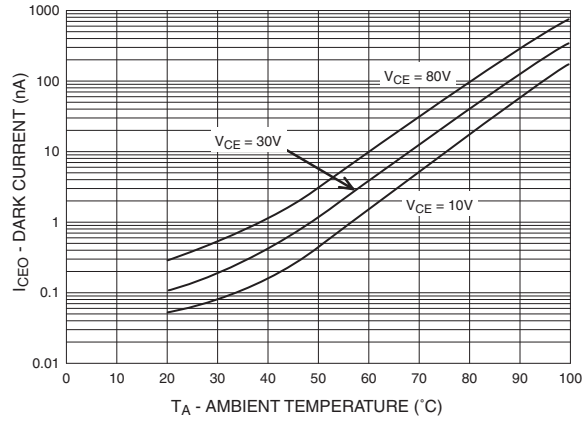

**Fig. 5 Input Current vs. Total Switching Speed (Typical Values)**

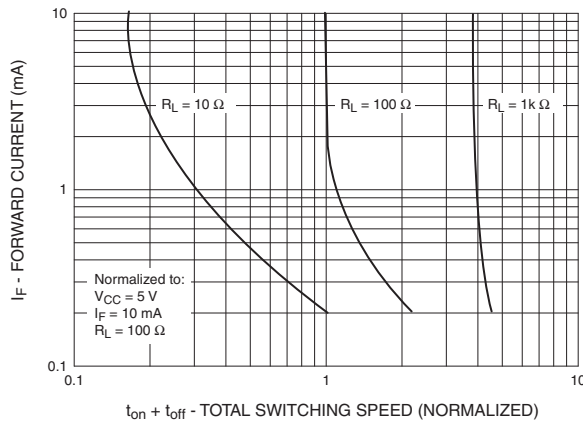



H11G1, H11G2, H11G3

## ORDERING INFORMATION

Option	Order Entry Identifier	Description
S	.S	Surface Mount Lead Bend
SD	.SD	Surface Mount; Tape and reel
W	.W	0.4" Lead Spacing
300	.300	VDE 0884
300W	.300W	VDE 0884, 0.4" Lead Spacing
3S	.3S	VDE 0884, Surface Mount
3SD	.3SD	VDE 0884, Surface Mount, Tape & Reel

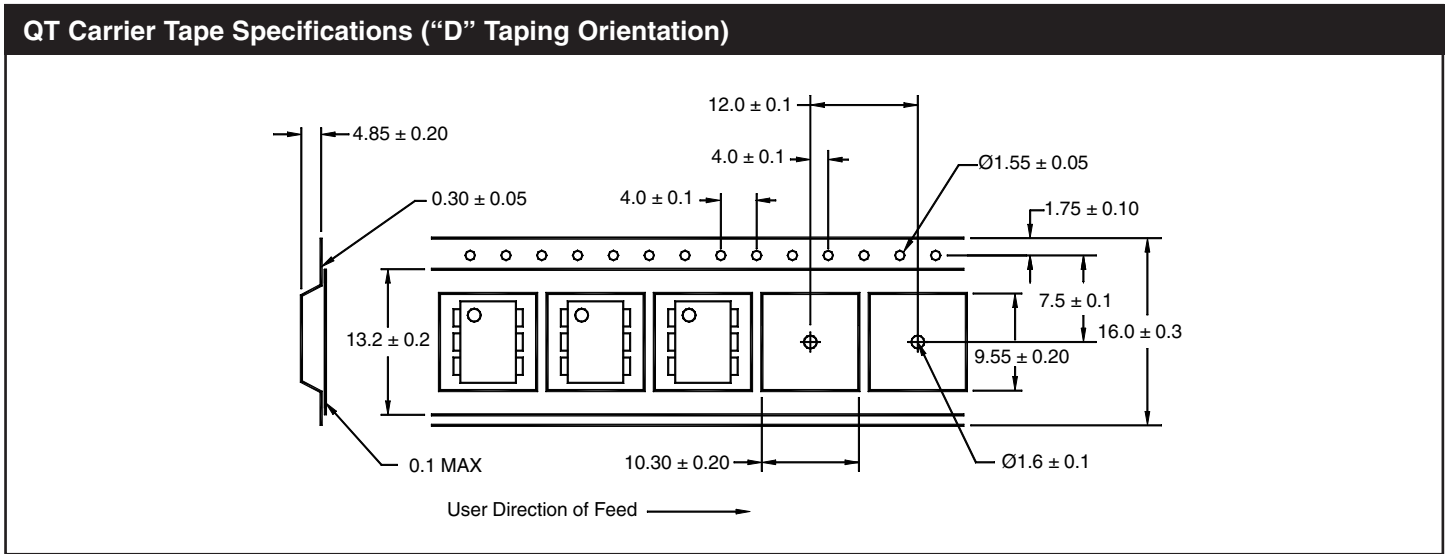

**NOTE**

All dimensions are in millimeters

## **DISCLAIMER**

FAIRCHILD SEMICONDUCTOR RESERVES THE RIGHT TO MAKE CHANGES WITHOUT FURTHER NOTICE TO ANY PRODUCTS HEREIN TO IMPROVE RELIABILITY, FUNCTION OR DESIGN. FAIRCHILD DOES NOT ASSUME ANY LIABILITY ARISING OUT OF THE APPLICATION OR USE OF ANY PRODUCT OR CIRCUIT DESCRIBED HEREIN; NEITHER DOES IT CONVEY ANY LICENSE UNDER ITS PATENT RIGHTS, NOR THE RIGHTS OF OTHERS.



## **LIFE SUPPORT POLICY**

FAIRCHILD'S PRODUCTS ARE NOT AUTHORIZED FOR USE AS CRITICAL COMPONENTS IN LIFE SUPPORT DEVICES OR SYSTEMS WITHOUT THE EXPRESS WRITTEN APPROVAL OF THE PRESIDENT OF FAIRCHILD SEMICONDUCTOR CORPORATION. As used herein:

1. Life support devices or systems are devices or systems which, (a) are intended for surgical implant into the body, or (b) support or sustain life, and (c) whose failure to perform when properly used in accordance with instructions for use provided in the labeling, can be reasonably expected to result in a significant injury of the user.
2. A critical component in any component of a life support device or system whose failure to perform can be reasonably expected to cause the failure of the life support device or system, or to affect its safety or effectiveness.

## Looking for pricing, stock, or lifecycle information?

Click below to explore more details on WIN SOURCE:

-  [View H11G3S on WIN SOURCE](#)
-  [Fairchild/ON Semiconductor Information](#)

## Optimize Your Supply Chain with WIN SOURCE Solutions

-  Global Sourcing Solution
-  Obsolete Management
-  Cost Control Management
-  Shortage Management
-  Alternative Solution
-  Excess Inventory Management