



**THE DATASHEET OF
AP131-35WL-7**



Description

The AP131 is a 300mA, fixed output voltage, low dropout linear regulator. The Device included pass element, error amplifier, band-gap, current limit and thermal shutdown circuitry. The device is ON when the EN pin is set to logic high level.

The characteristics of low dropout voltage and less quiescent current make it good for some critical current applications, for example, some battery powered devices. The typical quiescent current is approximately 50µA from zero to maximum load. Due to the internal flexible design, it results in extensively fixed output voltage versions and makes it convenient to use for applications. Built-in current-limit and thermal-shutdown functions prevent any fault condition from IC damage. An external capacitor can be connected to the BP pin and reduce the output noise.

Features

- Input Voltage Range is from 2.7V to 5.5V
- Dropout Voltage 400mV at 300mA Output Current
- Guaranteed 300mA Output Current
- Internal $R_{on} = 1.5\Omega$ PMOS Draws no Base Current
- Low Quiescent Current 50µA
- Output Voltage: 1.5V/1.8V/2.0V/2.5V/2.8V/2.9V/3.0V/3.3V/ 3.5V; Accuracy 2%
- Active Low Shutdown Function (EN pin)
- Fast Transient Response
- Good Load Regulation
- Current Limit and Thermal Shutdown Protection
- Short-Circuit Current Fold-Back
- Lead Free package: SOT25
- SOT25: Available in "Green" Molding Compound (No Br, Sb)
- **Totally Lead-Free & Fully RoHS Compliant (Notes 1 & 2)**
- **Halogen and Antimony Free. "Green" Device (Note 3)**

- Notes:
1. No purposely added lead. Fully EU Directive 2002/95/EC (RoHS), 2011/65/EU (RoHS 2) & 2015/863/EU (RoHS 3) compliant.
 2. See <https://www.diodes.com/quality/lead-free/> for more information about Diodes Incorporated's definitions of Halogen- and Antimony-free, "Green" and Lead-free.
 3. Halogen- and Antimony-free "Green" products are defined as those which contain <900ppm bromine, <900ppm chlorine (<1500ppm total Br + Cl) and <1000ppm antimony compounds.

Pin Assignments

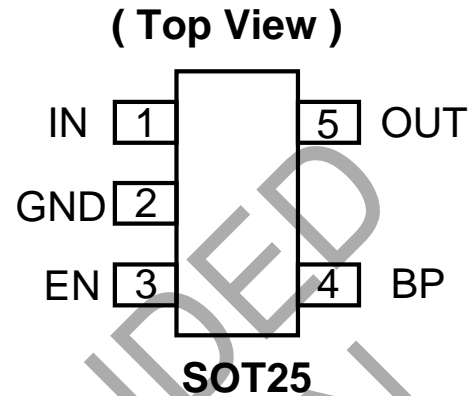

Applications

- Battery Powered Device
- Wireless Communication
- CD-ROM, DVD, and LAN Card
- PC Peripheral

Typical Applications Circuit

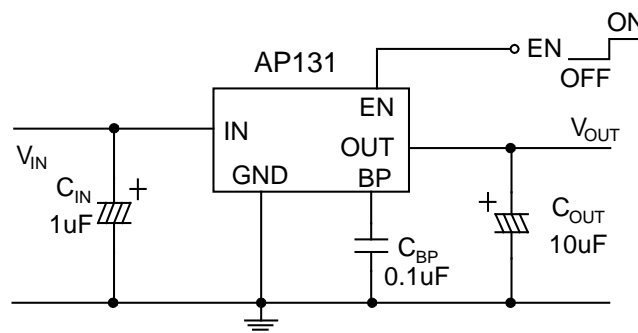

Pin Descriptions

Pin Name	Description
IN	Input Voltage
GND	Ground
EN	Enable Pin
BP	Band-Gap
OUT	Output Voltage

Functional Block Diagram

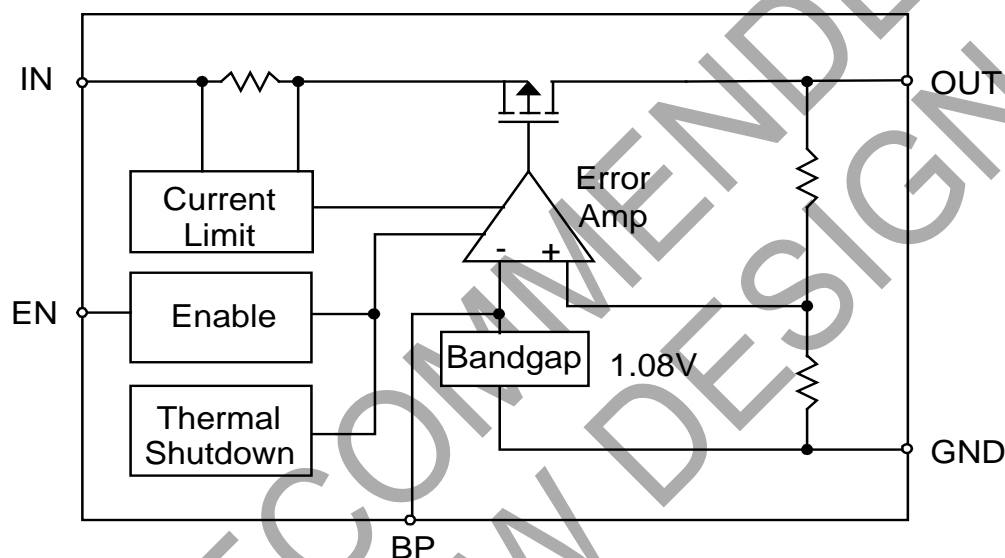

Absolute Maximum Ratings (@ $T_A = +25^\circ\text{C}$, unless otherwise specified.)

Symbol	Parameter	Rating	Unit
V_{CC}	Input Voltage	+6	V
T_{OP}	Operating Junction Temperature Range	-40 to +125	$^\circ\text{C}$
T_{ST}	Storage Temperature Range	-65 to +150	$^\circ\text{C}$
P_D	Power Dissipation, P_D @ $T_A = 25^\circ\text{C}$	250	mW

Recommended Operating Conditions (@ $T_A = +25^\circ\text{C}$, unless otherwise specified.)

Symbol	Parameter	Min	Max	Unit
V_{IN}	Input Voltage	2.7	5.5	V
I_{OUT}	Output Current	0	300	mA
T_A	Operating Ambient Temperature	-40	85	$^\circ\text{C}$

Electrical Characteristics (@ $T_A = +25^\circ\text{C}$, unless otherwise specified.)

 $T_A = 25^\circ\text{C}$, $C_{IN} = 1\mu\text{F}$, $C_{OUT} = 10\mu\text{F}$, unless otherwise specified.

Symbol	Parameter	Conditions	Min	Typ.	Max	Unit
V_{DROP}	Dropout Voltage (Note 4)	$I_L = 300\text{mA}$	—	400	500	mV
I_{LIMIT}	Current Limit (Note 5)	$V_{IN} = 5\text{V}$, $V_{OUT} = 0\text{V}$	350	450	—	mA
I_{short}	Short Circuit Current	$V_{OUT} < 1.05\text{V}$	—	150	300	mA
ΔV_{LINE}	Line Regulation	$I_{OUT} = 1\text{mA}$, $V_{IN} = (V_{OUT} + 1\text{V})$ to 5.5V	—	0.1	0.3	%/V
ΔV_{LOAD}	Load Regulation (Note 6)	$I_L = 1\sim 300\text{mA}$, $V_{IN} = 5\text{V}$	—	30	35	mV
ΔV_{OUT}	Output Voltage Accuracy	$I_L = 1\text{mA}$, $V_{IN} = 5\text{V}$	-2	—	+2	%
	Output Voltage Temperature Coefficient (Note 7)	—	—	50	150	PPM/ $^\circ\text{C}$
PSRR	Ripple Rejection	$F = 100\text{Hz}$, $C_{IN} = 1\mu\text{F}$, $C_O = 10\mu\text{F}$, $I_L = 100\text{mA}$	—	60	—	dB
I_{SB}	Standby Current	$I_L = 0\text{mA}$, $V_{IN} = 5\text{V}$, $EN = 0\text{V}$	—	—	5	μA
I_Q	Quiescent Current	$I_L = 0\text{mA}$, $V_{IN} = 5\text{V}$, $EN = 5\text{V}$	—	50	100	μA
I_{EN}	Enable Pin Current	—	—	—	< 0.1	μA
V_{ENON}	Enable Pin Voltage	Output ON	1.5	—	V_{IN}	V
V_{ENOFF}		Output OFF	0	—	0.8	V
T_{DELAY}	Enable Delay Time	$C_{BP} = 0.1\mu\text{F}$, $C_{OUT} = 1\mu\text{F}$, $I_{OUT} = 30\text{mA}$	—	8	—	μs
θ_{JA}	Thermal Resistance Junction-to-Ambient	SOT25 (Note 8)	—	163	—	$^\circ\text{C/W}$
θ_{JC}	Thermal Resistance Junction-to-Case	SOT25 (Note 8)	—	53	—	$^\circ\text{C/W}$

- Notes:
- Dropout voltage is defined as the input to output differential voltage. Dropout is measured at constant junction temperature by using pulsed ON time, and the criterion is V_{OUT} inside target value $\pm 2\%$. This test is skipped at the condition of $V_{IN} < 3\text{V}$.
 - Current limit is measured at constant junction temperature by using pulsed testing with a low ON time.
 - Regulation is measured at constant junction temperature by using pulsed testing with a low ON time.
 - Guaranteed by design.
 - Test conditions for SOT25: Device mounted on FR-4 substrate PC board, 2oz copper, with minimum recommended pad layout.

Typical Characteristics

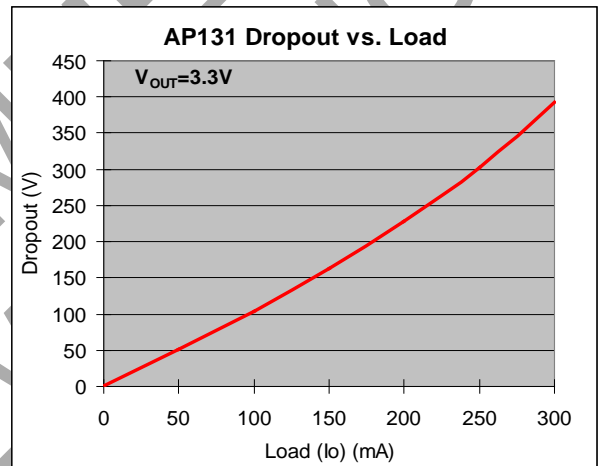
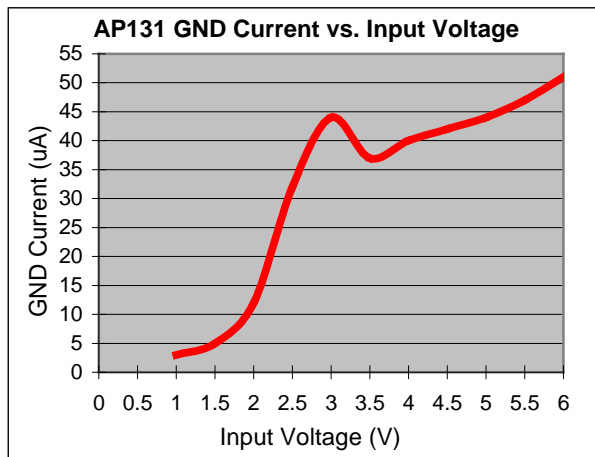
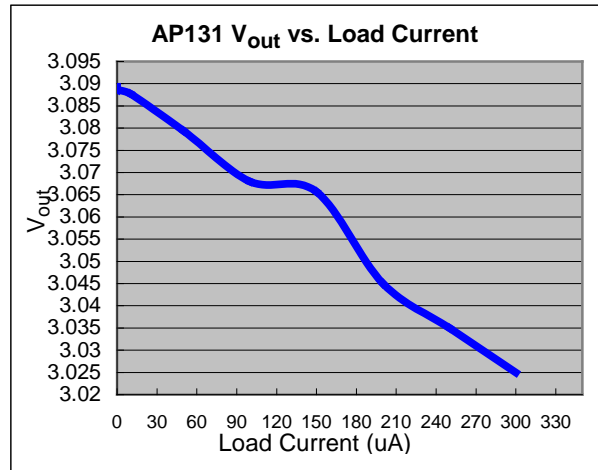
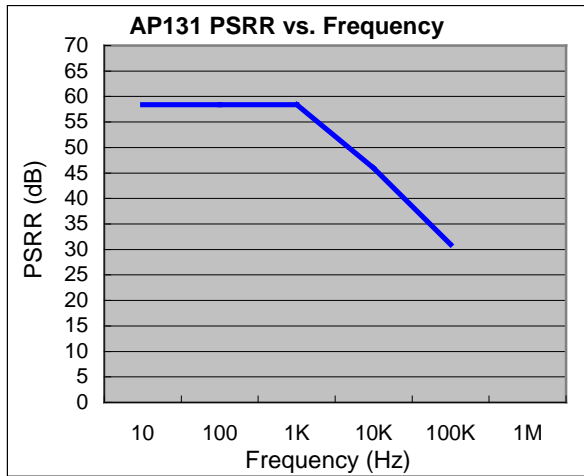

NOT FOR NEW DESIGN

Ordering Information

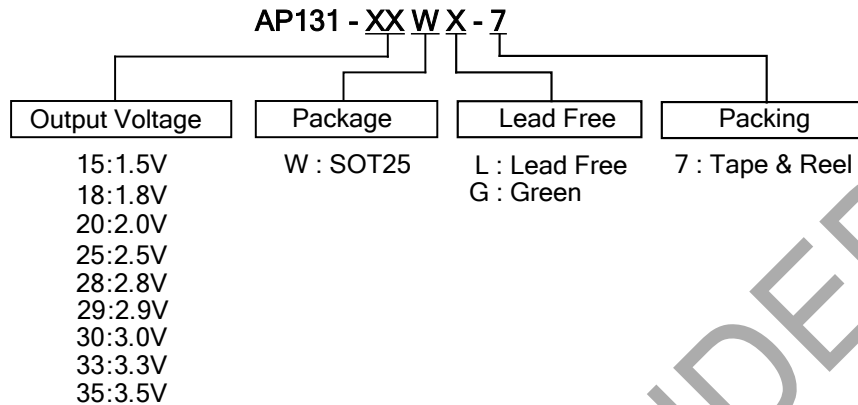

Device	Package Code	Packaging (Note 2)	7" Tape and Reel	
			Quantity	Part Number Suffix
AP131-XXWL-7	W	SOT25	3000/Tape & Reel	-7
AP131-XXWG-7	W	SOT25	3000/Tape & Reel	-7

Marking Information

(1) SOT25

(Top View)

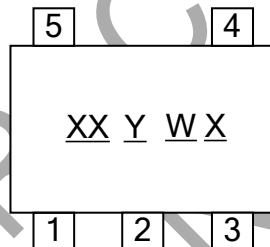

XX : Identification code
Y : Year 0~9
W : Week : A~Z : 1~26 week;
 a~z : 27~52 week; z represents
 52 and 53 week
X : a~z : Lead Free
 A~Z : Green

Part Number	Package	Identification Code
AP131-15W	SOT25	DA
AP131-18W	SOT25	DD
AP131-20W	SOT25	DF
AP131-25W	SOT25	DK
AP131-28W	SOT25	DN
AP131-29W	SOT25	DO
AP131-30W	SOT25	DP
AP131-33W	SOT25	DS
AP131-35W	SOT25	DU

Package Outline Dimensions

Please see <http://www.diodes.com/package-outlines.html> for the latest version.

SOT25

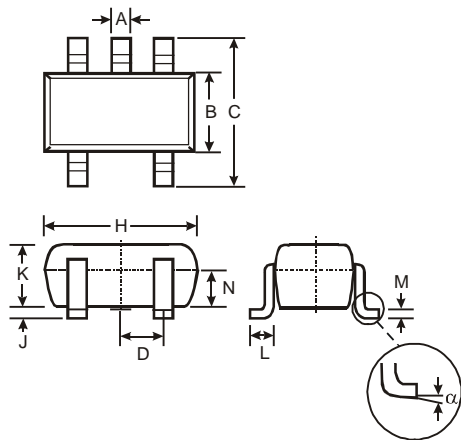

SOT25			
Dim	Min	Max	Typ
A	0.35	0.50	0.38
B	1.50	1.70	1.60
C	2.70	3.00	2.80
D	-	-	0.95
H	2.90	3.10	3.00
J	0.013	0.10	0.05
K	1.00	1.30	1.10
L	0.35	0.55	0.40
M	0.10	0.20	0.15
N	0.70	0.80	0.75
α	0°	8°	-
All Dimensions in mm			

Suggested Pad Layout

Please see <http://www.diodes.com/package-outlines.html> for the latest version.

SOT25

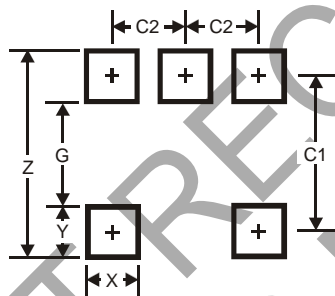

Dimensions	Value
Z	3.20
G	1.60
X	0.55
Y	0.80
C1	2.40
C2	0.95

IMPORTANT NOTICE

DIODES INCORPORATED MAKES NO WARRANTY OF ANY KIND, EXPRESS OR IMPLIED, WITH REGARDS TO THIS DOCUMENT, INCLUDING, BUT NOT LIMITED TO, THE IMPLIED WARRANTIES OF MERCHANTABILITY AND FITNESS FOR A PARTICULAR PURPOSE (AND THEIR EQUIVALENTS UNDER THE LAWS OF ANY JURISDICTION).

Diodes Incorporated and its subsidiaries reserve the right to make modifications, enhancements, improvements, corrections or other changes without further notice to this document and any product described herein. Diodes Incorporated does not assume any liability arising out of the application or use of this document or any product described herein; neither does Diodes Incorporated convey any license under its patent or trademark rights, nor the rights of others. Any Customer or user of this document or products described herein in such applications shall assume all risks of such use and will agree to hold Diodes Incorporated and all the companies whose products are represented on Diodes Incorporated website, harmless against all damages.

Diodes Incorporated does not warrant or accept any liability whatsoever in respect of any products purchased through unauthorized sales channel. Should Customers purchase or use Diodes Incorporated products for any unintended or unauthorized application, Customers shall indemnify and hold Diodes Incorporated and its representatives harmless against all claims, damages, expenses, and attorney fees arising out of, directly or indirectly, any claim of personal injury or death associated with such unintended or unauthorized application.

Products described herein may be covered by one or more United States, international or foreign patents pending. Product names and markings noted herein may also be covered by one or more United States, international or foreign trademarks.

This document is written in English but may be translated into multiple languages for reference. Only the English version of this document is the final and determinative format released by Diodes Incorporated.

LIFE SUPPORT

Diodes Incorporated products are specifically not authorized for use as critical components in life support devices or systems without the express written approval of the Chief Executive Officer of Diodes Incorporated. As used herein:

A. Life support devices or systems are devices or systems which:

1. are intended to implant into the body, or
2. support or sustain life and whose failure to perform when properly used in accordance with instructions for use provided in the labeling can be reasonably expected to result in significant injury to the user.

B. A critical component is any component in a life support device or system whose failure to perform can be reasonably expected to cause the failure of the life support device or to affect its safety or effectiveness.



Customers represent that they have all necessary expertise in the safety and regulatory ramifications of their life support devices or systems, and acknowledge and agree that they are solely responsible for all legal, regulatory and safety-related requirements concerning their products and any use of Diodes Incorporated products in such safety-critical, life support devices or systems, notwithstanding any devices- or systems-related information or support that may be provided by Diodes Incorporated. Further, Customers must fully indemnify Diodes Incorporated and its representatives against any damages arising out of the use of Diodes Incorporated products in such safety-critical, life support devices or systems.

Copyright © 2019, Diodes Incorporated

www.diodes.com

Looking for pricing, stock, or lifecycle information?

Click below to explore more details on WIN SOURCE:

-  [View AP131-35WL-7 on WIN SOURCE](#)
-  [Diodes Incorporated Information](#)

Optimize Your Supply Chain with WIN SOURCE Solutions

-  Global Sourcing Solution
-  Obsolete Management
-  Cost Control Management
-  Shortage Management
-  Alternative Solution
-  Excess Inventory Management