



**THE DATASHEET OF
AP139-20WG-7**



Features

- Very Low Dropout Voltage
- Low Current Consumption: Typ. 45µA, max. 60µA
- Output Voltage: 1.5V, 1.8V, 2.0V, 2.5V, 2.8V, 3.0V, 3.3V, and 3.5V
- Guaranteed 300mA Output
- Input Range from 2.7 up to 5.5V
- Thermal Shutdown
- Current Limiting
- Stability with Low ESR Capacitors
- Low Temperature Coefficient
- Lead Free Package: SOT25
- SOT25: Available in "Green" Molding Compound (No Br, Sb)
- Lead Free Finish/RoHS Compliant (Note 1)

General Description

The AP139 is a positive voltage linear regulator utilizing CMOS technology. The features that include low quiescent current (45µA typ.), low dropout voltage, and high output voltage accuracy, make it ideal for battery applications. EN input connected to the device will produce a low bias current. The space-saving SOT25 package is attractive for "pocket" and "hand held" applications.

This rugged device has both thermal shutdown, and current limit protections to prevent device failure under the "worst" operating conditions.

In a low noise, regulated supply application, a 10nF capacitor is necessary to be placed in between Bypass and Ground.

The AP139 is stable with a low ESR output capacitor of 1.0µF or greater.

Applications

- Personal Communication Devices
- Home Electric/Electronic Appliances
- PC Peripherals
- Battery-Powered Devices

Ordering Information

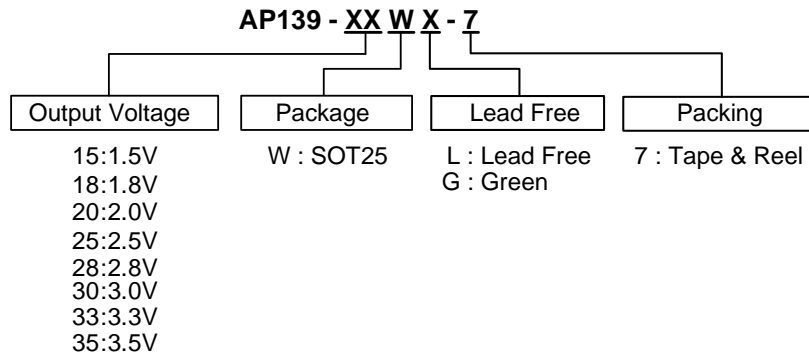

Device	Package Code	Packaging (Note 2)	7" Tape and Reel	
			Quantity	Part Number Suffix
AP139-XXWL-7	W	SOT25	3000/Tape & Reel	-7
AP139-XXWG-7	W	SOT25	3000/Tape & Reel	-7



Notes: 1. EU Directive 2002/95/EC (RoHS). All applicable RoHS exemptions applied. Please visit our website at http://www.diodes.com/products/lead_free.html.
 2. Pad layout as shown on Diodes Inc. suggested pad layout document AP02001, which can be found on our website at <http://www.diodes.com/datasheets/ap02001.pdf>.

Pin Assignments

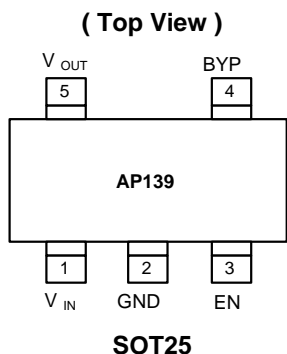

Pin Descriptions

Pin Name	Pin No.	Description
V _{IN}	1	Power Supply
GND	2	Ground
EN	3	Enable Pin
BYP	4	Bypass Signal Pin
V _{OUT}	5	Output

Block Diagram

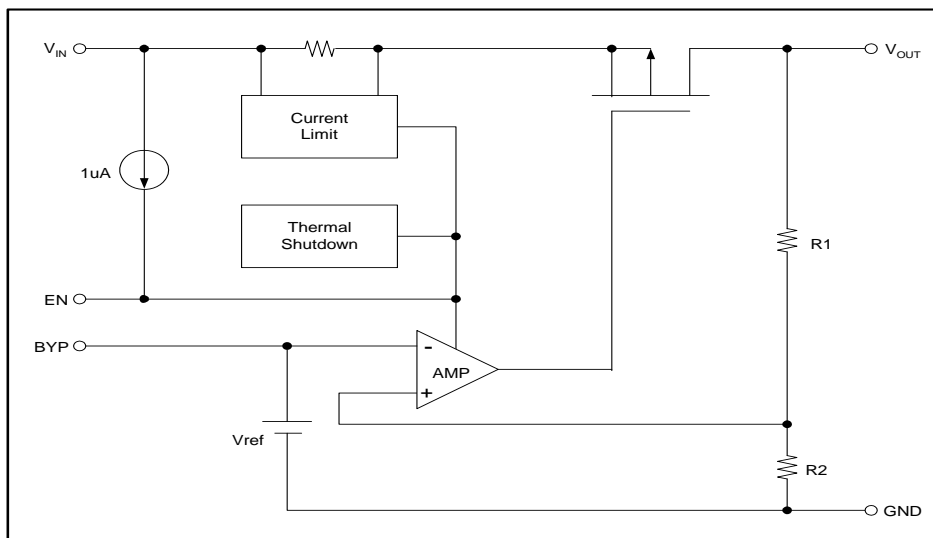

Absolute Maximum Ratings

Symbol	Parameter	Rating	Unit
V _{IN}	Input Voltage	+6	V
I _{OUT}	Output Current	P _D /(V _{IN} -V _O)	mA
V _{OUT}	Output Voltage	GND - 0.3 to V _{IN} + 0.3	V
	ESD Classification	B	
T _{OP}	Operating Junction Temperature Range	-40 to +125	°C
T _{MJ}	Maximum Junction Temperature	150	°C
P _D	Internal Power Dissipation	250	mW

Recommended Operating Conditions

Symbol	Parameter	Min	Max	Unit
V_{IN}	Input voltage	2.7	5.5	V
I_{OUT}	Output Current	0	300	mA
T_A	Operating Ambient Temperature	-40	85	°C

Electrical Characteristics ($T_A = +25^\circ\text{C}$, unless otherwise noted)

Symbol	Parameter	Test Conditions	Min	Typ.	Max	Unit	
V_{IN}	Input Voltage		Note 3	-	5.5	V	
I_Q	Quiescent Current	$I_O = 0\text{mA}$	-	45	60	μA	
I_{STB}	Standby Current	$V_{IN} = 5.0\text{V}$, $V_{OUT} = 0\text{V}$, $V_{EN} < V_{EL}$	-	2.0	3.0	μA	
V_{OUT}	Output Voltage Accuracy	$I_O = 1\text{mA}$, $V_{IN} = 5\text{V}$	-2	-	2	%	
	V_{OUT} Temperature Coefficient		-	50	-	ppm/°C	
$V_{DROPOUT}$	Dropout Voltage	$I_O = 1\text{mA}$ to 300mA , $V_{OUT} = V_{O(NOM)} - 1.5\%$ $V_O \geq 2.8\text{V}$	-	-	0.45	V	
I_{OUT}	Output Current		300	-	-	mA	
I_{LIMIT}	Current Limit	$V_{OUT} > 1.05\text{V}$	300	450	-	mA	
I_{short}	Short Circuit Current	$V_{CC} = 5\text{V}$, $V_{OUT} < 1.05\text{V}$	-	150	300	mA	
ΔV_{LINE}	Line Regulation	$I_{OUT} = 1\text{mA}$, $V_{IN} = (V_{OUT} + 1\text{V})$ to 5.5V	-	0.1	0.3	%	
ΔV_{LOAD}	Load Regulation	$I_O = 1\text{mA}$ to 300mA , $V_{IN} = 5\text{V}$	-	0.3	1	%	
PSRR	Power Supply Rejection	$I_O = 100\text{mA}$, $C_O = 2.2\mu\text{F}$ ceramic	$f = 1\text{KHz}$	-	60	-	dB
			$f = 10\text{KHz}$	-	50	-	
			$f = 100\text{KHz}$	-	40	-	
PSRR	Power Supply Rejection	$I_O = 100\text{mA}$, $C_O = 2.2\mu\text{F}$ ceramic, $C_{BYP} = 20\text{nF}$	$f = 1\text{KHz}$	-	75	-	dB
			$f = 10\text{KHz}$	-	55	-	
			$f = 100\text{KHz}$	-	30	-	
V_{EH}	EN Input Threshold	Output ON	1.7	-	-	V	
V_{EL}		Output OFF	-	-	0.8	V	
I_{EN}	Enable Pin Current		-	-	<0.1	μA	
OTS	Over Temperature Shutdown		-	130	-	°C	
OTH	Over Temperature Hysteresis		-	20	-	°C	
θ_{JA}	Thermal Resistance	SOT25 (Note 4)		226		°C/W	
θ_{JC}	Thermal Resistance	SOT25 (Note 4)		34		°C/W	

Notes: 3. $V_{IN(MIN)} = V_{OUT} + V_{DROPOUT}$.

4. Test conditions for SOT25: Devices mounted on FR-4 PC board, MRP, 1 oz. copper, single sided, calibrate at $T_J = 85^\circ\text{C}$, measure at $T_A = 25^\circ\text{C}$, no heat Sink, no air flow.

Typical Application

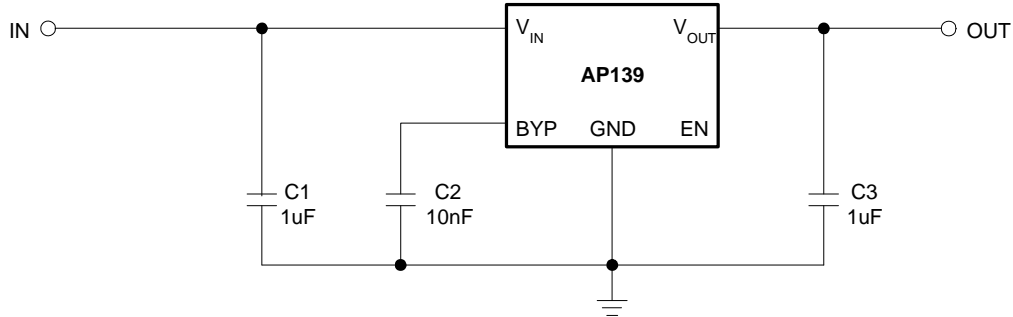

Typical Performance Characteristics

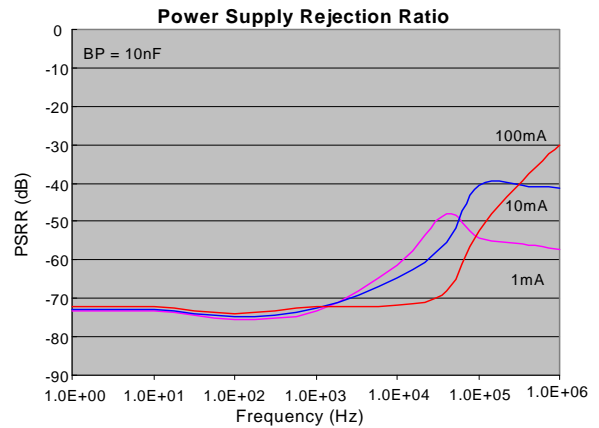
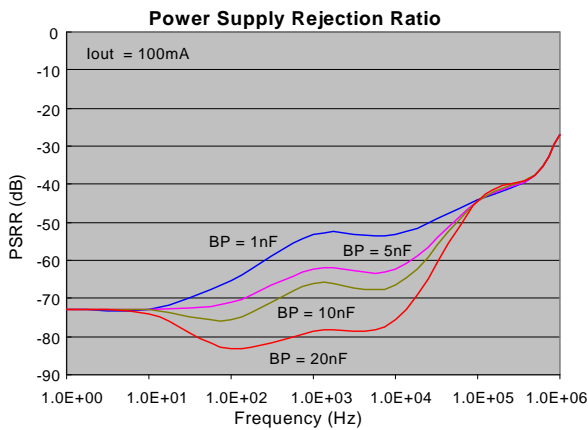
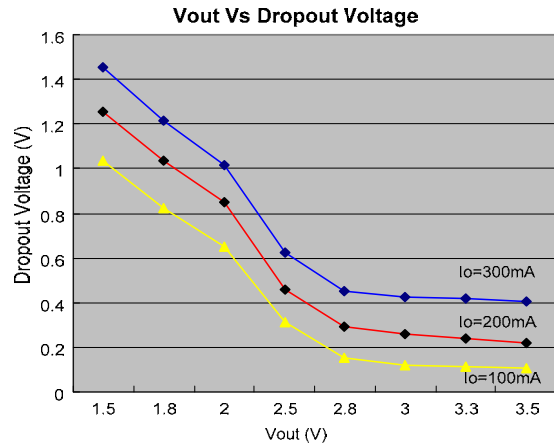
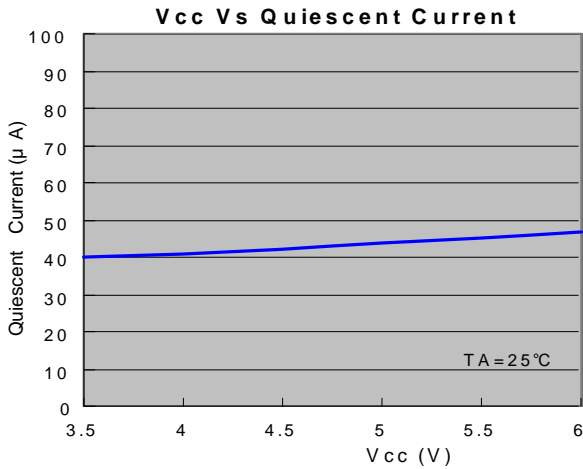

Typical Performance Characteristics (Continued)

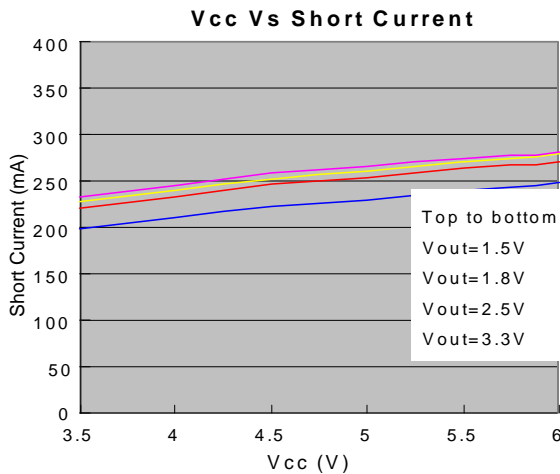
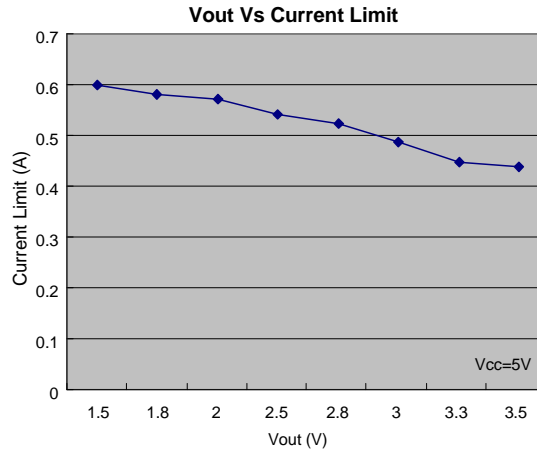
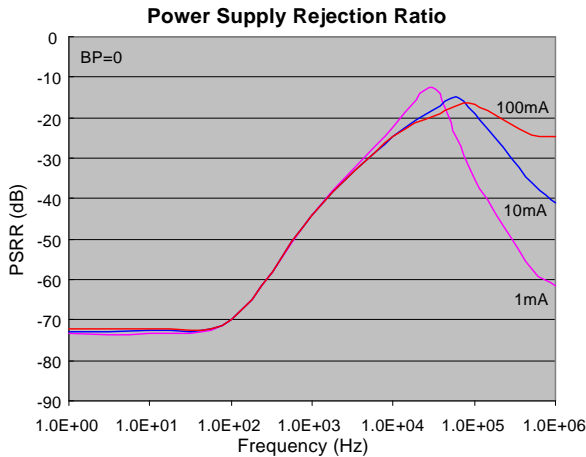

Functional Description

The AP139 of CMOS regulators contain a PMOS pass transistor, voltage reference, error amplifier, over-current protection, thermal shutdown.

The P-channel pass transistor receives data from the error amplifier, over-current protection, and thermal protection circuits. During normal operation, the error amplifier compares the output voltage to a precision reference. The over-current and thermal shutdown circuits become active when the junction temperature exceeds 130°C, or the current exceeds 300mA. During thermal shutdown, the output voltage remains low. Normal operation is restored when the junction temperature drops below 110°C.

The AP139 switches from voltage mode to current mode when the load exceeds the rated output current. This prevents over-stress.

Enable

The enable pin normally floats high. When actively, pulled low, the PMOS pass transistor shuts off, and all internal circuits are powered down. In this state, the quiescent current is less than 2µA. This pin behaves much like an electronic switch.

External Capacitor

The AP139 is stable with a low ESR output capacitor to ground of 1.0µF or greater. It can keep stable even with higher ESR capacitors. A second capacitor is recommended between the input and ground to stabilize V_{IN}. The input capacitor should be larger than 0.1µF to have a beneficial effect. All capacitors should be placed in close proximity to the pins. A “quiet” ground termination is desirable.

Marking Information

(1) SOT25

(Top View)

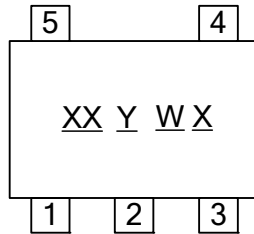

XX : Identification code
Y : Year 0~9
W : Week : A~Z : 1~26 week;
 a~z : 27~52 week; z represents
 52 and 53 week
X : a~z : Lead Free
 A~Z : Green

Part Number	Package	Identification Code
AP139-15W	SOT25	N0
AP139-18W	SOT25	N1
AP139-20W	SOT25	N2
AP139-25W	SOT25	N3
AP139-28W	SOT25	N4
AP139-30W	SOT25	N5
AP139-33W	SOT25	N6
AP139-35W	SOT25	N7

Package Information (All Dimensions in mm)

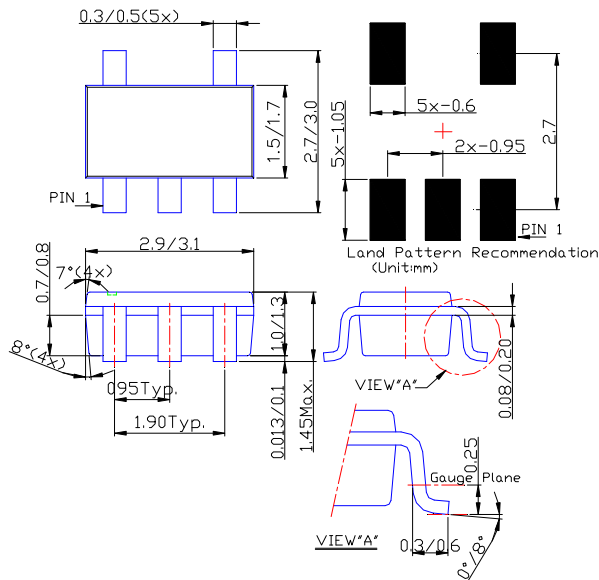

IMPORTANT NOTICE

Diodes Incorporated and its subsidiaries reserve the right to make modifications, enhancements, improvements, corrections or other changes without further notice to any product herein. Diodes Incorporated does not assume any liability arising out of the application or use of any product described herein; neither does it convey any license under its patent rights, nor the rights of others. The user of products in such applications shall assume all risks of such use and will agree to hold Diodes Incorporated and all the companies whose products are represented on our website, harmless against all damages.

LIFE SUPPORT

Diodes Incorporated products are not authorized for use as critical components in life support devices or systems without the expressed written approval of the President of Diodes Incorporated.

Looking for pricing, stock, or lifecycle information?

Click below to explore more details on WIN SOURCE:

- ⊖ [View AP139-20WG-7 on WIN SOURCE](#)
- ⊖ [Diodes Incorporated Information](#)

Optimize Your Supply Chain with WIN SOURCE Solutions

- ✓ Global Sourcing Solution
- ✓ Obsolete Management
- ✓ Cost Control Management
- ✓ Shortage Management
- ✓ Alternative Solution
- ✓ Excess Inventory Management