



**THE DATASHEET OF
SN75LP1185DWR**



SN75LP1185 LOW-POWER MULTIPLE RS-232 DRIVERS AND RECEIVERS

SLLS335A – JANUARY 1999 – REVISED JANUARY 2001

AVAILABLE OPTIONS

T _A	PACKAGED DEVICES		
	PLASTIC SHRINK SMALL-OUTLINE (DB)	PLASTIC SMALL OUTLINE (DW)	PLASTIC DIP (N)
0°C to 70°C	SN75LP1185DBR	SN75LP1185DW	SN75LP1185N

The DB package is only available taped and reeled. The DW package also is available taped and reeled. Add the suffix R to device type (e.g., SN75LP1185DWR).

Function Tables

DRIVER

INPUT DA	OUTPUT DY
H	L
L	H
Open	L

RECEIVER

INPUT RA	OUTPUT RY
H	L
L	H
Open	H

logic diagram (positive logic)

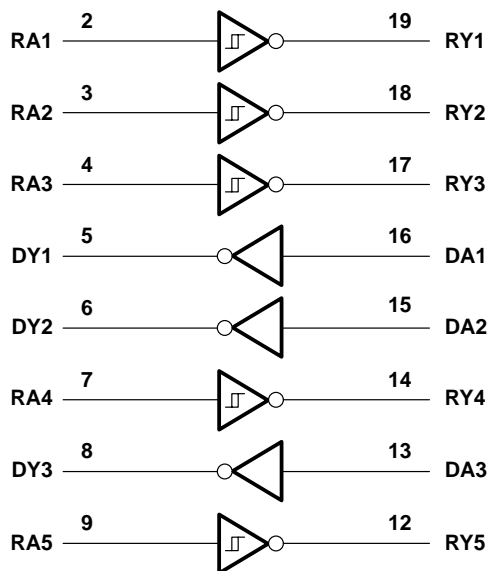

SN75LP1185

LOW-POWER MULTIPLE RS-232 DRIVERS AND RECEIVERS

SLLS335A – JANUARY 1999 – REVISED JANUARY 2001

absolute maximum ratings over operating free-air temperature range (unless otherwise noted)†

Positive supply-voltage range (see Note 1): V_{CC}	–0.5 V to 7 V
V_{DD}	–0.5 V to 15 V
Negative supply-voltage range, V_{SS} (see Note 1)	0.5 V to –15 V
Input-voltage range, V_I : Receiver (RA)	–30 V to 30 V
Driver (DA)	–0.5 V to $V_{CC} + 0.4$ V
Output-voltage range, V_O : Receiver (RY)	–0.5 V to 6 V
Driver (DY)	–15 V to 15 V
Electrostatic discharge: Bus pins (human-body model) (see Note 2)	Class 3: 15 kV
Bus pins (machine model)	500 V
All pins (human-body model) (see Note 2)	Class 3: 5 kV
All pins (machine model)	400 V
Package thermal impedance, θ_{JA} (see Note 3): DB package	70°C/W
DW package	58°C/W
N package	69°C/W
Lead temperature 1,6 mm (1/16 inch) from case for 10 seconds	260°C
Storage temperature range, T_{stg}	65°C to 150°C

† Stresses beyond those listed under “absolute maximum ratings” may cause permanent damage to the device. These are stress ratings only, and functional operation of the device at these or any other conditions beyond those indicated under “recommended operating conditions” is not implied. Exposure to absolute-maximum-rated conditions for extended periods may affect device reliability.

- NOTES: 1. All voltage values are with respect to network ground terminal, unless otherwise noted.
 2. Per MIL-STD-883, Method 3015.7
 3. The package thermal impedance is calculated in accordance with JESD 51-7.

recommended operating conditions

		MIN	NOM	MAX	UNIT
V_{CC}	Supply voltage (see Note 4)	4.75	5	5.25	V
V_{DD}	Supply voltage (see Note 5)	9	12	15	V
V_{SS}	Supply voltage (see Note 5)	–9	–12	–15	V
V_{IH}	High-level input voltage		2		V
V_{IL}	Low-level input voltage			0.8	V
V_I	Receiver input voltage		–25	25	V
I_{OH}	High-level output current			–1	mA
I_{OL}	Low-level output current			2	mA
T_A	Operating free-air temperature		0	70	°C

- NOTES: 4. V_{CC} cannot be greater than V_{DD} .
 5. The device operates down to $V_{DD} = V_{CC}$ and $|V_{SS}| = V_{CC}$, but supply currents increase and other parameters may vary slightly from the data sheet limits.



SN75LP1185

LOW-POWER MULTIPLE RS-232 DRIVERS AND RECEIVERS

SLLS335A – JANUARY 1999 – REVISED JANUARY 2001

supply currents over the recommended operating conditions (unless otherwise noted)

PARAMETER	TEST CONDITIONS	MIN	TYP	MAX	UNIT
Supply current for V_{CC} , I_{CC}	$V_{DD} = 9\text{ V}$, $V_{SS} = -9\text{ V}$			1000	μA
	$V_{DD} = 12\text{ V}$, $V_{SS} = -12\text{ V}$			1000	
Supply current for V_{DD} , I_{DD}	No load, All inputs at minimum V_{OH} or maximum V_{OL}	$V_{DD} = 9\text{ V}$, $V_{SS} = -9\text{ V}$		800	
		$V_{DD} = 12\text{ V}$, $V_{SS} = -12\text{ V}$		800	
Supply current for V_{SS} , I_{SS}		$V_{DD} = 9\text{ V}$, $V_{SS} = -9\text{ V}$		-625	
		$V_{DD} = 12\text{ V}$, $V_{SS} = -12\text{ V}$		-625	

driver electrical characteristics over the recommended operating conditions (unless otherwise noted)

PARAMETER	TEST CONDITIONS	MIN	TYP	MAX	UNIT	
V_{OH} High-level output voltage	$V_{IL} = 0.8\text{ V}$, $R_L = 3\text{ k}\Omega$, See Figure 1	$V_{DD} = 9\text{ V}$, $V_{SS} = -9\text{ V}$	5	5.8	6.6	V
		$V_{DD} = 12\text{ V}$, $V_{SS} = -12\text{ V}$, See Note 6	5	5.8	6.6	
V_{OL} Low-level output voltage	$V_{IH} = 2\text{ V}$, $R_L = 3\text{ k}\Omega$, See Figure 1	$V_{DD} = 9\text{ V}$, $V_{SS} = -9\text{ V}$	-5	-5.8	-6.9	V
		$V_{DD} = 12\text{ V}$, $V_{SS} = -12\text{ V}$, See Note 6	-5	-5.9	-6.9	
I_{IH} High-level input current	V_I at V_{CC}			1	μA	
I_{IL} Low-level input current	V_I at GND			-1	μA	
$I_{OS(H)}$ Short-circuit high-level output current	$V_O = \text{GND}$ or V_{SS} . See Figure 2 and Note 7		-30	-55	mA	
$I_{OS(L)}$ Short-circuit low-level output current	$V_O = \text{GND}$ or V_{DD} . See Figure 2 and Note 7		30	55	mA	
r_o Output resistance	$V_{DD} = V_{SS} = V_{CC} = 0$, $V_O = 2\text{ V}$	300			Ω	

NOTES: 6. Maximum output swing is clamped nominally at $\pm 6\text{ V}$ to enable the higher data rates associated with this device and to reduce EMI emissions. The driver outputs may slightly exceed the maximum output voltage over the full V_{CC} and temperature ranges.
7. Not more than one output should be shorted at one time.



SN75LP1185

LOW-POWER MULTIPLE RS-232 DRIVERS AND RECEIVERS

SLLS335A – JANUARY 1999 – REVISED JANUARY 2001

driver switching characteristics over recommended operating free-air temperature range (unless otherwise noted)

PARAMETER		TEST CONDITIONS	MIN	TYP	MAX	UNIT		
t_{PHL}	Propagation delay time, high- to low-level output	$R_L = 3\text{ k}\Omega$ to $7\text{ k}\Omega$, $C_L = 15\text{ pF}$, See Figure 1	300	800	1600	ns		
t_{PLH}	Propagation delay time, low- to high-level output	$R_L = 3\text{ k}\Omega$ to $7\text{ k}\Omega$, $C_L = 15\text{ pF}$, See Figure 1	300	800	1600	ns		
t_{TLH}	Transition time, low- to high-level output	$V_{CC} = 5\text{ V}$, $V_{DD} = 12\text{ V}$, $V_{SS} = -12\text{ V}$, $R_L = 3\text{ k}\Omega$ to $7\text{ k}\Omega$, See Figure 1 and Note 9	Using $V_{TR} = 10\%$ -to- 90% transition region, Driver speed = 250 kbit/s , $C_L = 15\text{ pF}$, See Note 8		375	2240	ns	
			Using $V_{TR} = \pm 3\text{ V}$ transition region, Driver speed = 250 kbit/s , $C_L = 15\text{ pF}$		200	1500		
			Using $V_{TR} = \pm 2\text{ V}$ transition region, Driver speed = 250 kbit/s , $C_L = 15\text{ pF}$		133	1000		
			Using $V_{TR} = \pm 3\text{ V}$ transition region, Driver speed = 125 kbit/s , $C_L = 2500\text{ pF}$			2750		
t_{THL}	Transition time, high- to low-level output	$V_{CC} = 5\text{ V}$, $V_{DD} = 12\text{ V}$, $V_{SS} = -12\text{ V}$, $R_L = 3\text{ k}\Omega$ to $7\text{ k}\Omega$, See Figure 1 and Note 9	Using $V_{TR} = 10\%$ -to- 90% transition region, Driver speed = 250 kbit/s , $C_L = 15\text{ pF}$, See Note 8		375	2240	ns	
			Using $V_{TR} = \pm 3\text{ V}$ transition region, Driver speed = 250 kbit/s , $C_L = 15\text{ pF}$		200	1500		
			Using $V_{TR} = \pm 2\text{ V}$ transition region, Driver speed = 250 kbit/s , $C_L = 15\text{ pF}$		133	1000		
			Using $V_{TR} = \pm 3\text{ V}$ transition region, Driver speed = 125 kbit/s , $C_L = 2500\text{ pF}$			2750		
SR	Output slew rate	$V_{CC} = 5\text{ V}$, $V_{DD} = 12\text{ V}$, $V_{SS} = -12\text{ V}$	Using $V_{TR} = \pm 3\text{ V}$ transition region, Driver speed = 0 to 250 kbit/s , $C_L = 15\text{ pF}$		4	20	30	V/ μs

NOTES: 8. Equivalent to the SN75C185. The SN75LP1185 output-voltage swing is clamped to about 70% of the typical SN75C185 output-voltage swing, and the specified limits reflect the reduced output swing.

9. Maximum output swing is limited to $\pm 6\text{ V}$ to enable the higher data rates associated with this device and to reduce EMI emissions.

receiver electrical characteristics over recommended operating free-air temperature range (unless otherwise noted)

PARAMETER		TEST CONDITIONS	MIN	TYP	MAX	UNIT
V_{IT+}	Positive-going input threshold voltage	See Figure 3	1.6	2	2.55	V
V_{IT-}	Negative-going input threshold voltage	See Figure 3	0.6	1	1.45	V
V_{HYS}	Input hysteresis, $V_{IT+} - V_{IT-}$	See Figure 3	600	1000		mV
V_{OH}	High-level output voltage	$I_{OH} = -1\text{ mA}$	2.5	3.9		V
V_{OL}	Low-level output voltage	$I_{OL} = 2\text{ mA}$		0.33	0.5	V
I_{IH}	High-level input current	$V_I = 3\text{ V}$	0.43	0.6	1	mA
		$V_I = 25\text{ V}$	3.6	5.1	8.3	
I_{IL}	Low-level input current	$V_I = -3\text{ V}$	-0.43	-0.6	-1	mA
		$V_I = -25\text{ V}$	-3.6	-5.1	-8.3	
$I_{OS(H)}$	Short-circuit high-level output current	$V_O = 0$, See Figure 5 and Note 7			-20	mA
$I_{OS(L)}$	Short-circuit low-level output current	$V_O = V_{CC}$, See Figure 5 and Note 7			20	mA
R_{IN}	Input resistance	$V_I = \pm 3\text{ V}$ to $\pm 25\text{ V}$	3	5	7	k Ω

NOTE 7: Not more than one output should be shorted at one time.



SN75LP1185 LOW-POWER MULTIPLE RS-232 DRIVERS AND RECEIVERS

SLLS335A – JANUARY 1999 – REVISED JANUARY 2001

receiver switching characteristics over recommended operating free-air temperature range, $C_L = 50 \text{ pF}$ (unless otherwise noted) (see Figure 4)

PARAMETER		MIN	TYP	MAX	UNIT
t_{PHL}	Propagation delay time, high- to low-level output		400	900	ns
t_{PLH}	Propagation delay time, low- to high-level output		400	900	ns
t_{TLH}	Transition time, low- to high-level output		200	500	ns
t_{THL}	Transition time, high- to low-level output		200	400	ns
$t_{SK(p)}$	Pulse skew $ t_{PLH} - t_{PHL} $		200	425	ns

PARAMETER MEASUREMENT INFORMATION

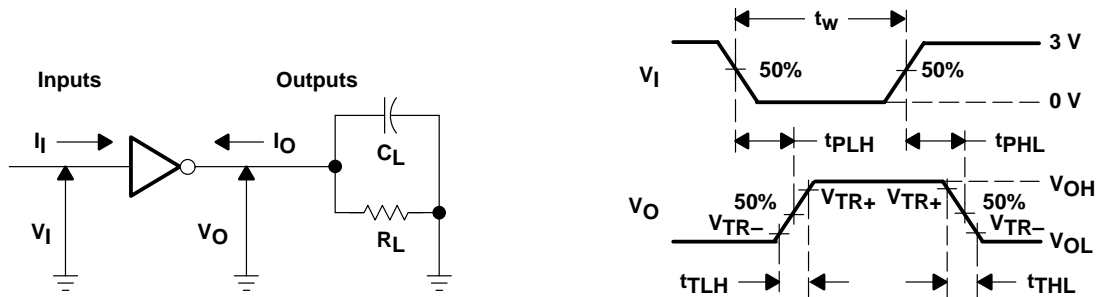

- NOTES: A. The pulse generator has the following characteristics:
 For $C_L < 1000 \text{ pF}$: $t_w = 4 \mu\text{s}$, $\text{PRR} = 250 \text{ kbit/s}$, $Z_O = 50 \Omega$, t_r and $t_f < 50 \text{ ns}$.
 For $C_L = 2500 \text{ pF}$: $t_w = 8 \mu\text{s}$, $\text{PRR} = 125 \text{ kbit/s}$, $Z_O = 50 \Omega$, t_r and $t_f < 50 \text{ ns}$.
 B. C_L includes probe and jig capacitance.

Figure 1. Driver Parameter Test Circuit and Waveform

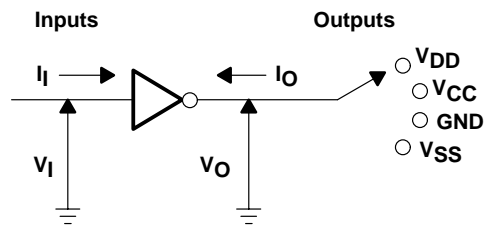

Figure 2. Driver I_{OS} Test

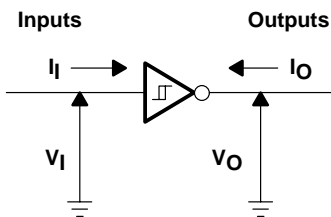
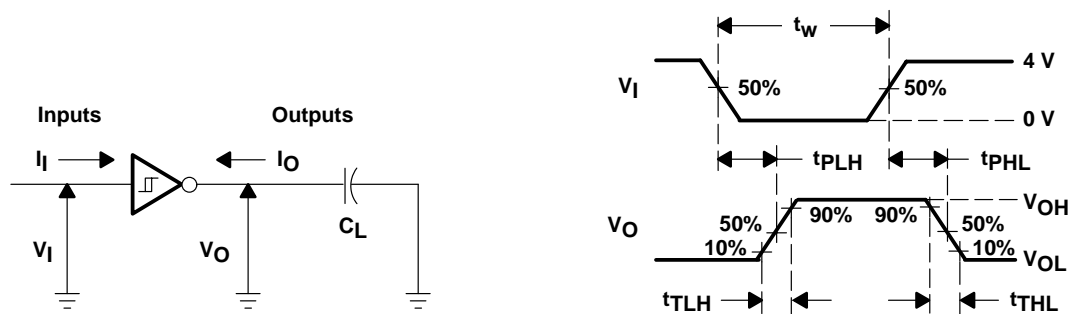

Figure 3. Receiver V_{IT} Test

PARAMETER MEASUREMENT INFORMATION



NOTES: A. The pulse generator has the following characteristics: $t_w = 4 \mu s$, PRR = 250 kbit/s, $Z_O = 50 \Omega$, t_r and $t_f < 50 ns$.
B. C_L includes probe and jig capacitance.

Figure 4. Receiver Parameter Test Circuit and Waveform

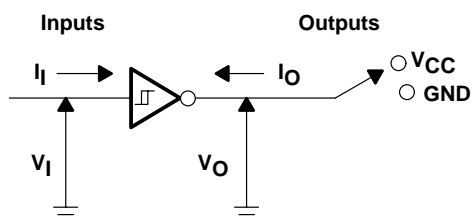

Figure 5. Receiver I_{OS} Test

APPLICATION INFORMATION

Diodes placed in series with the V_{DD} and V_{SS} leads protect the SN75LP1185 in the fault condition when the device outputs are shorted to $\pm 15 V$ and the power supplies are at low voltage and provide low-impedance paths to ground (see Figure 6).

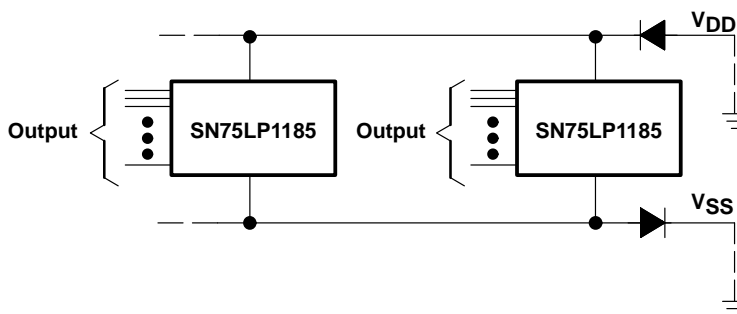

Figure 6. Power-Supply Protection to Meet Power-Off Fault Conditions of TIA/EIA-232-F

PACKAGING INFORMATION

Orderable Device	Status (1)	Package Type	Package Drawing	Pins	Package Qty	Eco Plan (2)	Lead finish/ Ball material (6)	MSL Peak Temp (3)	Op Temp (°C)	Device Marking (4/5)	Samples
SN75LP1185DBR	ACTIVE	SSOP	DB	20	2000	RoHS & Green	NIPDAU	Level-1-260C-UNLIM	0 to 70	5LP1185	Samples
SN75LP1185DW	ACTIVE	SOIC	DW	20	25	RoHS & Green	NIPDAU	Level-1-260C-UNLIM	0 to 70	75LP1185	Samples
SN75LP1185DWR	ACTIVE	SOIC	DW	20	2000	RoHS & Green	NIPDAU	Level-1-260C-UNLIM	0 to 70	75LP1185	Samples

(1) The marketing status values are defined as follows:

ACTIVE: Product device recommended for new designs.

LIFEBUY: TI has announced that the device will be discontinued, and a lifetime-buy period is in effect.

NRND: Not recommended for new designs. Device is in production to support existing customers, but TI does not recommend using this part in a new design.

PREVIEW: Device has been announced but is not in production. Samples may or may not be available.

OBSOLETE: TI has discontinued the production of the device.

(2) **RoHS:** TI defines "RoHS" to mean semiconductor products that are compliant with the current EU RoHS requirements for all 10 RoHS substances, including the requirement that RoHS substance do not exceed 0.1% by weight in homogeneous materials. Where designed to be soldered at high temperatures, "RoHS" products are suitable for use in specified lead-free processes. TI may reference these types of products as "Pb-Free".

RoHS Exempt: TI defines "RoHS Exempt" to mean products that contain lead but are compliant with EU RoHS pursuant to a specific EU RoHS exemption.

Green: TI defines "Green" to mean the content of Chlorine (Cl) and Bromine (Br) based flame retardants meet JS709B low halogen requirements of <=1000ppm threshold. Antimony trioxide based flame retardants must also meet the <=1000ppm threshold requirement.

(3) MSL, Peak Temp. - The Moisture Sensitivity Level rating according to the JEDEC industry standard classifications, and peak solder temperature.

(4) There may be additional marking, which relates to the logo, the lot trace code information, or the environmental category on the device.

(5) Multiple Device Markings will be inside parentheses. Only one Device Marking contained in parentheses and separated by a "~" will appear on a device. If a line is indented then it is a continuation of the previous line and the two combined represent the entire Device Marking for that device.

(6) Lead finish/Ball material - Orderable Devices may have multiple material finish options. Finish options are separated by a vertical ruled line. Lead finish/Ball material values may wrap to two lines if the finish value exceeds the maximum column width.

Important Information and Disclaimer:The information provided on this page represents TI's knowledge and belief as of the date that it is provided. TI bases its knowledge and belief on information provided by third parties, and makes no representation or warranty as to the accuracy of such information. Efforts are underway to better integrate information from third parties. TI has taken and continues to take reasonable steps to provide representative and accurate information but may not have conducted destructive testing or chemical analysis on incoming materials and chemicals. TI and TI suppliers consider certain information to be proprietary, and thus CAS numbers and other limited information may not be available for release.

In no event shall TI's liability arising out of such information exceed the total purchase price of the TI part(s) at issue in this document sold by TI to Customer on an annual basis.

TAPE AND REEL INFORMATION

QUADRANT ASSIGNMENTS FOR PIN 1 ORIENTATION IN TAPE



*All dimensions are nominal

Device	Package Type	Package Drawing	Pins	SPQ	Reel Diameter (mm)	Reel Width W1 (mm)	A0 (mm)	B0 (mm)	K0 (mm)	P1 (mm)	W (mm)	Pin1 Quadrant
SN75LP1185DBR	SSOP	DB	20	2000	330.0	16.4	8.2	7.5	2.5	12.0	16.0	Q1
SN75LP1185DWR	SOIC	DW	20	2000	330.0	24.4	10.8	13.3	2.7	12.0	24.0	Q1

TAPE AND REEL BOX DIMENSIONS

*All dimensions are nominal

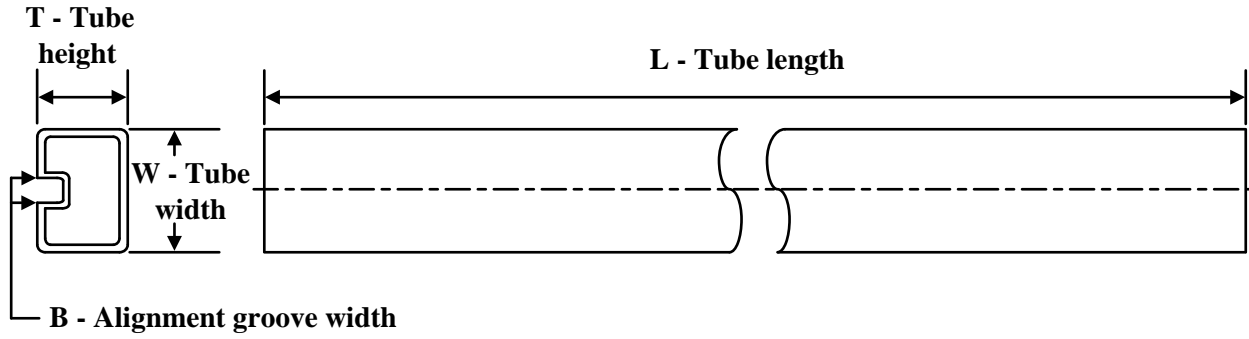
Device	Package Type	Package Drawing	Pins	SPQ	Length (mm)	Width (mm)	Height (mm)
SN75LP1185DBR	SSOP	DB	20	2000	356.0	356.0	35.0
SN75LP1185DWR	SOIC	DW	20	2000	367.0	367.0	45.0

TUBE

*All dimensions are nominal

Device	Package Name	Package Type	Pins	SPQ	L (mm)	W (mm)	T (μm)	B (mm)
SN75LP1185DW	DW	SOIC	20	25	507	12.83	5080	6.6

DB0020A



PACKAGE OUTLINE

SSOP - 2 mm max height

SMALL OUTLINE PACKAGE



4214851/B 08/2019

NOTES:

1. All linear dimensions are in millimeters. Any dimensions in parenthesis are for reference only. Dimensioning and tolerancing per ASME Y14.5M.
2. This drawing is subject to change without notice.
3. This dimension does not include mold flash, protrusions, or gate burrs. Mold flash, protrusions, or gate burrs shall not exceed 0.15 mm per side.
4. This dimension does not include interlead flash. Interlead flash shall not exceed 0.25 mm per side.
5. Reference JEDEC registration MO-150.

EXAMPLE BOARD LAYOUT

DB0020A

SSOP - 2 mm max height

SMALL OUTLINE PACKAGE



LAND PATTERN EXAMPLE
EXPOSED METAL SHOWN
SCALE: 10X



4214851/B 08/2019

NOTES: (continued)

- 6. Publication IPC-7351 may have alternate designs.
- 7. Solder mask tolerances between and around signal pads can vary based on board fabrication site.

EXAMPLE STENCIL DESIGN

DB0020A

SSOP - 2 mm max height

SMALL OUTLINE PACKAGE

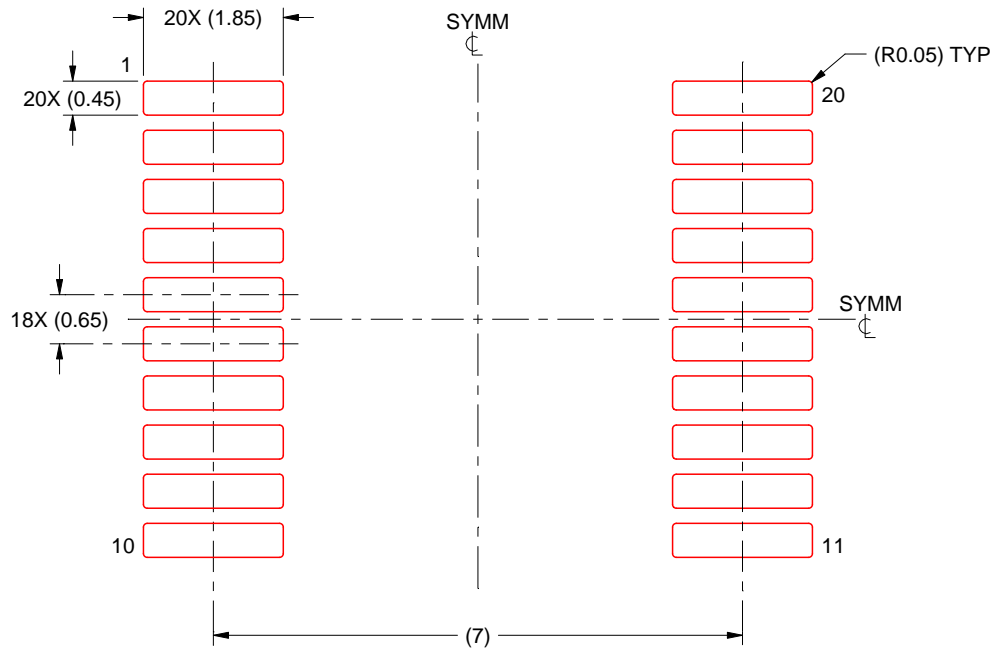

SOLDER PASTE EXAMPLE
BASED ON 0.125 mm THICK STENCIL
SCALE: 10X

4214851/B 08/2019

NOTES: (continued)

8. Laser cutting apertures with trapezoidal walls and rounded corners may offer better paste release. IPC-7525 may have alternate design recommendations.
9. Board assembly site may have different recommendations for stencil design.

DW0020A



PACKAGE OUTLINE

SOIC - 2.65 mm max height

SOIC



4220724/A 05/2016

NOTES:

1. All linear dimensions are in millimeters. Dimensions in parenthesis are for reference only. Dimensioning and tolerancing per ASME Y14.5M.
2. This drawing is subject to change without notice.
3. This dimension does not include mold flash, protrusions, or gate burrs. Mold flash, protrusions, or gate burrs shall not exceed 0.15 mm per side.
4. This dimension does not include interlead flash. Interlead flash shall not exceed 0.43 mm per side.
5. Reference JEDEC registration MS-013.

EXAMPLE BOARD LAYOUT

DW0020A

SOIC - 2.65 mm max height

SOIC



LAND PATTERN EXAMPLE
SCALE:6X



SOLDER MASK DETAILS

4220724/A 05/2016

NOTES: (continued)

- 6. Publication IPC-7351 may have alternate designs.
- 7. Solder mask tolerances between and around signal pads can vary based on board fabrication site.

EXAMPLE STENCIL DESIGN

DW0020A

SOIC - 2.65 mm max height

SOIC



SOLDER PASTE EXAMPLE
BASED ON 0.125 mm THICK STENCIL
SCALE:6X

4220724/A 05/2016

NOTES: (continued)

8. Laser cutting apertures with trapezoidal walls and rounded corners may offer better paste release. IPC-7525 may have alternate design recommendations.
9. Board assembly site may have different recommendations for stencil design.

IMPORTANT NOTICE AND DISCLAIMER

TI PROVIDES TECHNICAL AND RELIABILITY DATA (INCLUDING DATA SHEETS), DESIGN RESOURCES (INCLUDING REFERENCE DESIGNS), APPLICATION OR OTHER DESIGN ADVICE, WEB TOOLS, SAFETY INFORMATION, AND OTHER RESOURCES "AS IS" AND WITH ALL FAULTS, AND DISCLAIMS ALL WARRANTIES, EXPRESS AND IMPLIED, INCLUDING WITHOUT LIMITATION ANY IMPLIED WARRANTIES OF MERCHANTABILITY, FITNESS FOR A PARTICULAR PURPOSE OR NON-INFRINGEMENT OF THIRD PARTY INTELLECTUAL PROPERTY RIGHTS.

These resources are intended for skilled developers designing with TI products. You are solely responsible for (1) selecting the appropriate TI products for your application, (2) designing, validating and testing your application, and (3) ensuring your application meets applicable standards, and any other safety, security, regulatory or other requirements.

These resources are subject to change without notice. TI grants you permission to use these resources only for development of an application that uses the TI products described in the resource. Other reproduction and display of these resources is prohibited. No license is granted to any other TI intellectual property right or to any third party intellectual property right. TI disclaims responsibility for, and you will fully indemnify TI and its representatives against, any claims, damages, costs, losses, and liabilities arising out of your use of these resources.

TI's products are provided subject to [TI's Terms of Sale](#) or other applicable terms available either on [ti.com](https://www.ti.com) or provided in conjunction with such TI products. TI's provision of these resources does not expand or otherwise alter TI's applicable warranties or warranty disclaimers for TI products.

TI objects to and rejects any additional or different terms you may have proposed.

Mailing Address: Texas Instruments, Post Office Box 655303, Dallas, Texas 75265
Copyright © 2024, Texas Instruments Incorporated

Looking for pricing, stock, or lifecycle information?

Click below to explore more details on WIN SOURCE:

 [View SN75LP1185DWR on WIN SOURCE](#)

 [Texas Instruments](#) Information

Optimize Your Supply Chain with WIN SOURCE Solutions

-  Global Sourcing Solution
-  Obsolete Management
-  Cost Control Management
-  Shortage Management
-  Alternative Solution
-  Excess Inventory Management