



**THE DATASHEET OF
PTH12050YAD**



PTHxx050Y 3.3/5/12 Vin

Total Power: 10.8 Watts
of Outputs: Single

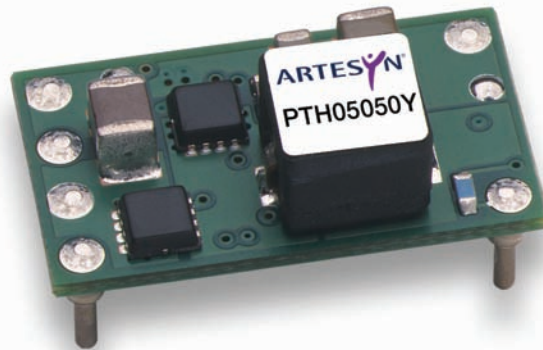

Rev. 3.23.09_137
PTHxx050Y Series
1 of 5



Special Features

- V_{TT} bus termination output (output the system V_{REF})
- 6 A output current (8 A peak)
- 3.3, 5, or 12 Vdc input voltage
- DDR and QDR compatible
- ON/OFF inhibit (for V_{TT} stand-by)
- Under-voltage lockout
- Operating temperature range: -40 °C to +85 °C
- Efficiencies up to 88%
- Output overcurrent protection (non-latching, auto-reset)
- Point-of-Load-Alliance (POLA) compatible
- Available RoHS compliant
- 2 Year Warranty

Safety

- UL/cUL CAN/CSA-C22.2 No. 60950 File No. E174104
- TÜV Product Service (EN60950) Certificate No. B 04 06 38572 044
- CB Report and Certificate to IEC60950, Certificate No. US/8292/UL

Specifications

Input		
Input current:	No load	10 mA
Input voltage range:	PTH03050Y PTH05050Y PTH12050Y	2.95 - 3.65 Vdc 4.5 - 5.5 Vdc 10.8 - 13.2 Vdc
Undervoltage lockout:		
	PTH03050Y	Vin increasing Vin decreasing 2.45 V typ., 2.80 V max. 2.20 V min., 2.40 V typ.
	PTH05050Y	Vin increasing Vin decreasing 4.30 V typ., 4.45 V max. 3.40 V min., 3.70 V typ.
	PTH12050Y	Vin increasing Vin decreasing 9.5 V typ., 10.4 V max. 8.80 V min., 9.0 V typ.
Input capacitance: (See Note 4, page 3)	PTH03050Y & PTH05050Y PTH12050Y	470 μ F 560 μ F
Remote ON/OFF:		Active high

All specifications are typical at nominal input, $V_{REF} = 1.25$ V, full load at 25 °C unless otherwise stated
 C_{in} , C_{o1} , C_{o2} = typical value



Specifications Continued

Output		
Output current: (over V_{REF} range)	All models Continuous (See Note 1, page 3) Repetitive pulse (See Note 2, page 3)	± 6 A ± 8 A
Tracking range for V_{REF} :		0.55 - 1.8 V
Tracking tolerance to V_{REF} ($V_{TT} - V_{REF}$): (over line, load & temperature)		-10 mV to + 10 mV
Ripple and noise:	20 MHz bandwidth	20 mV pk-pk
Load transient response: (See Note 5, page 3)		80 μ s settling time Overshoot/undershoot 25 mV typ.
Output capacitance:		
Non-ceramic values (See Notes 5 & 6, page 3)	PTH03050Y PTH05050Y PTH12050Y	470 μ F typ., 3,300 μ F max. 470 μ F typ., 3,300 μ F max. 940 μ F typ., 3,300 μ F max.
Ceramic values (See Note 5, page 3)	PTH03050Y PTH05050Y PTH12050Y	200 μ F typ., 300 μ F max. 200 μ F typ., 300 μ F max. 400 μ F typ., 600 μ F max.
(See Note 7, page 3)	ESR (non-ceramic)	4 m Ω min.

General Specifications		
Efficiency: $I_o = 4$ A	PTH03050Y PTH05050Y PTH12050Y	88% typ. 87% typ. 84% typ.
Insulation voltage:		Non-isolated
Switching frequency:	PTH03050Y PTH05050Y PTH12050Y	550 - 650 kHz 550 - 650 kHz 200 - 300 kHz
Approvals and standards:		EN60950 UL/cUL60950
Material flammability:		UL94V-0
Dimensions:	(L x W x H)	22.10 x 12.57 x 8.50 mm 0.870 x 0.495 x 0.335 in
Weight:		2.9 g (0.10 oz)
MTBF:	Telcordia SR-332	6,000,000 hours
Environmental Specifications		
Thermal Performance: (See Note 2, page 3)	Operating ambient, temperature Non-operating	-40 °C to +85 °C -40 °C to +125 °C
MSL ('Z' suffix only):	JEDEC J-STD-020C	Level 3
Protection		
Overcurrent threshold (auto reset):	All models	12 A typ.

Ordering Information

Output Power (max)	Input Voltage	V_{TT} Range	Output Currents		Efficiency (max)	Model Numbers ^(9, 10)
			Min	Max		
10.8 W	2.95 - 3.65 Vdc	0.55 - 1.8 Vdc	0 A	± 6 A	88%	PTH03050Y
10.8 W	4.5 - 5.5 Vdc	0.55 - 1.8 Vdc	0 A	± 6 A	88%	PTH05050Y
10.8 W	10.8 - 13.2 Vdc	0.55 - 1.8 Vdc	0 A	± 6 A	85%	PTH12050Y

Part Number System with Options

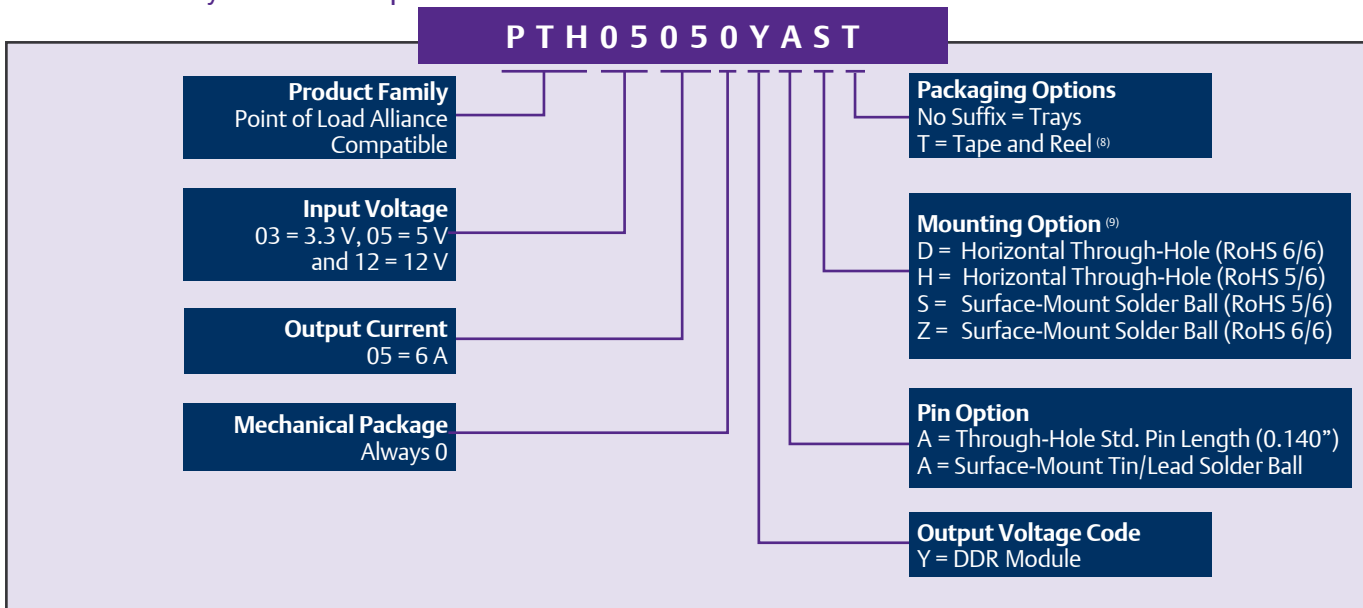

Notes

- Rating is conditional on the module being soldered to a 4 layer PCB with 1 oz. copper. See the SOA curves or contact the factory for appropriate derating. The PTH03050Y and PTH05050Y require no derating up to 85 °C operating temperature and natural convection airflow.
- Up to 10 ms pulse period at 10% maximum duty.
- This control pin has an internal pull-up to the input voltage V_{in} . If it is left open-circuit the module will operate when input power is applied. A small low-leakage (< 100 nA) MOSFET is recommended for control. For further information, consult Application Note 178.
- An input capacitor is required for proper operation. The capacitor must be rated for a minimum of 300 mA rms (750 mA rms for 12 V input) of ripple current.
- The typical value of external output capacitance value ensures that V_{TT} meets the specified transient performance requirements for the memory bus terminations. Lower values of capacitance may be possible when the measured peak change in output current is consistently less than 3 A. Test conditions were 15 A/ μ s load step, -1.5 A to +1.5 A.
- This is the calculated maximum. The minimum ESR limitation will often result in a lower value. Consult Application Note 178 for further details.
- This is the typical ESR for all the electrolytic (non-ceramic) output capacitance. Use 7 m Ω as the minimum when using max-ESR values to calculate.
- Tape and reel packaging only available on the surface-mount versions.
- To order Pb-free (RoHS compatible) surface-mount parts replace the mounting option 'S' with 'Z', e.g. PTHXX050YAZ. To order Pb-free (RoHS compatible) through-hole parts replace the mounting option 'H' with 'D', e.g. PTHXX050YAD.
- NOTICE: Some models do not support all options. Please contact your local Emerson Network Power representative or use the on-line model number search tool at <http://www.PowerConversion.com> to find a suitable alternative.

Characteristic Data

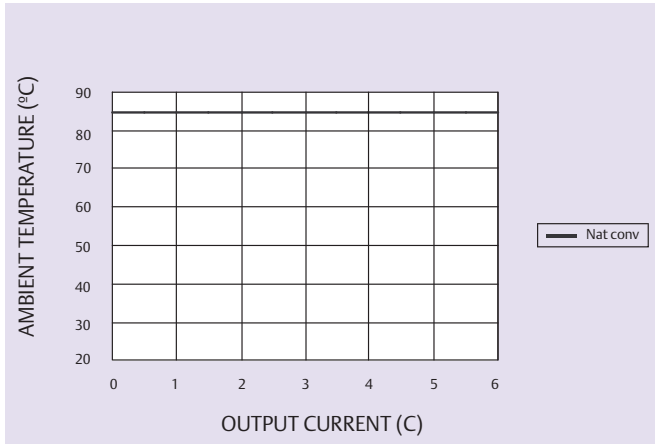

Figure 1 - Safe Operating Area
 $V_{in} = 3.3\text{ V}$, $V_{REF} = 1.25\text{ V}$, $I_{out} = 6\text{ A}$ (See Note A)

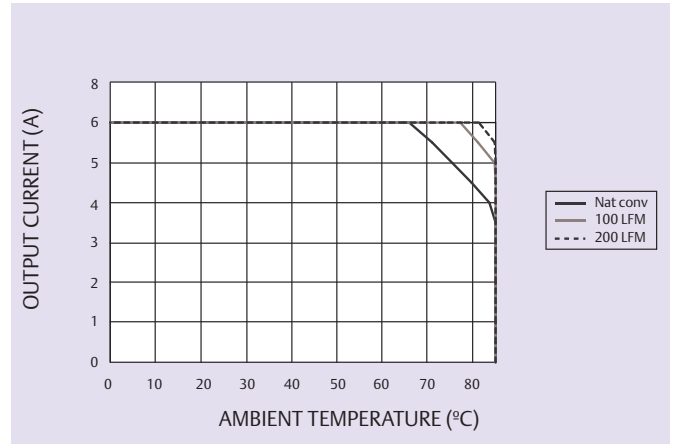

Figure 2 - Safe Operating Area
 $V_{in} = 12\text{ V}$, $V_{REF} = 1.25\text{ V}$, $I_{out} = 6\text{ A}$ (See Note A)

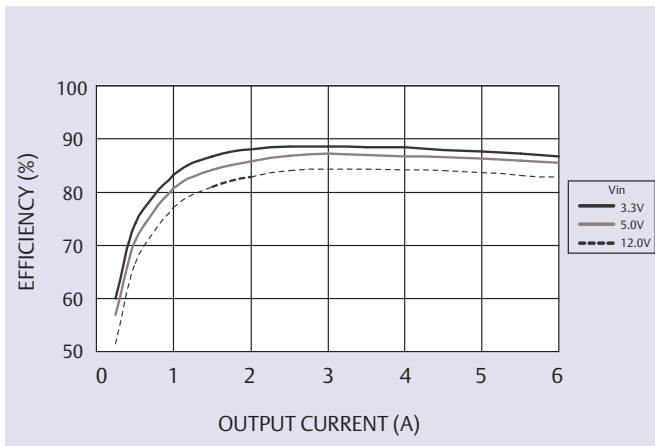

Figure 3 - Efficiency vs Load Current
 $V_{REF} = 1.25\text{ V}$ (See Note B)

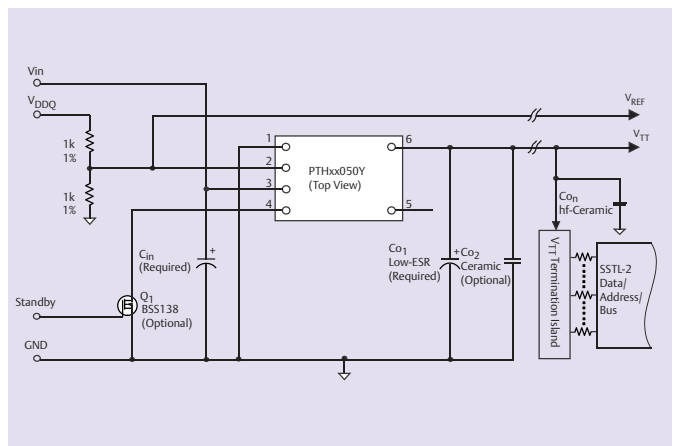

Figure 4 - Standard Application

Notes

- A SOA curves represent the conditions at which internal components are within the Emerson Network Power derating guidelines.
- B Characteristic data has been developed from actual products tested at 25 °C. This data is considered typical data for the converter.

Mechanical Drawings

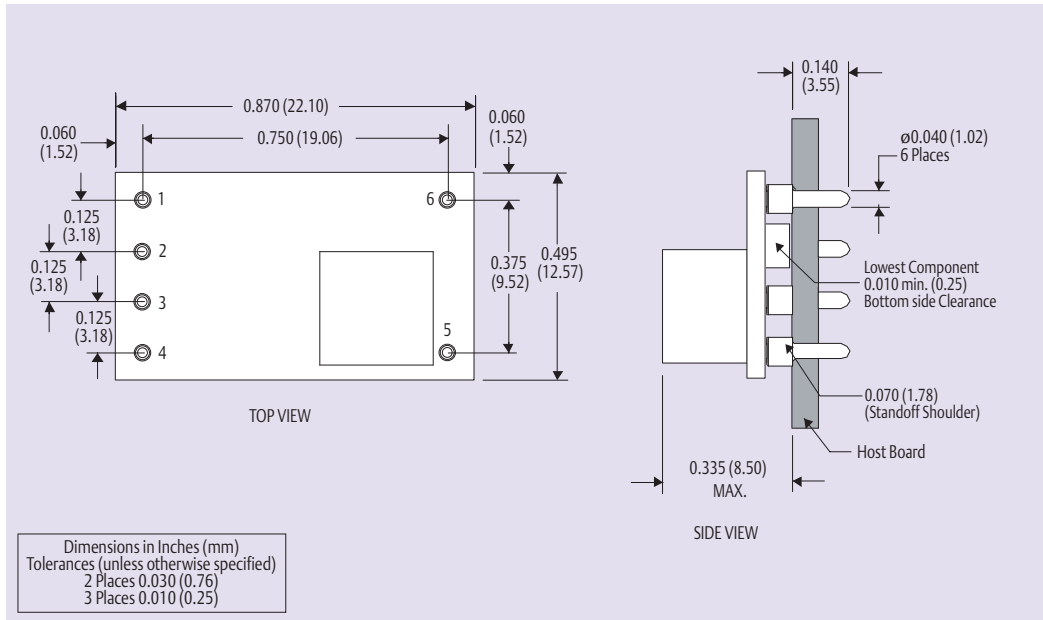

Figure 5 - Plated Through-Hole

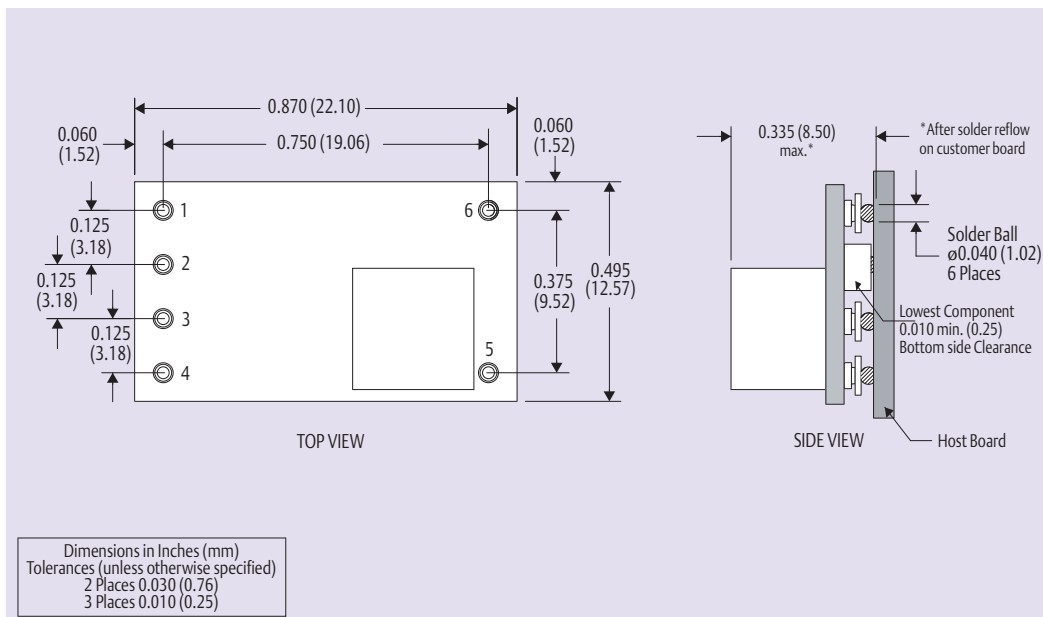

Figure 6 - Surface-Mount

Pin Connections	
Pin No.	Function
Pin 1	Ground
Pin 2	V _{REF}
Pin 3	V _{in}

Pin Connections cont.	
Pin No.	Function
Pin 4	Inhibit*
Pin 5	N/C
Pin 6	V _{TT}

* Denotes negative logic:
Open = Normal operation
Ground = Function active

Americas

5810 Van Allen Way
Carlsbad, CA 92008
USA
Telephone: +1 760 930 4600
Facsimile: +1 760 930 0698

Europe (UK)

Waterfront Business Park
Merry Hill, Dudley
West Midlands, DY5 1LX
United Kingdom
Telephone: +44 (0) 1384 842 211
Facsimile: +44 (0) 1384 843 355

Asia (HK)

14/F, Lu Plaza
2 Wing Yip Street
Kwun Tong, Kowloon
Hong Kong
Telephone: +852 2176 3333
Facsimile: +852 2176 3888

For global contact, visit:

www.PowerConversion.com
techsupport.embeddedpower@emerson.com

While every precaution has been taken to ensure accuracy and completeness in this literature, Emerson Network Power assumes no responsibility, and disclaims all liability for damages resulting from use of this information or for any errors or omissions.

Emerson Network Power.
The global leader in enabling business-critical continuity.



- AC Power
- Connectivity
- DC Power
- Embedded Computing
- Embedded Power
- Monitoring
- Outside Plant
- Power Switching & Controls
- Precision Cooling
- Racks & Integrated Cabinets
- Services
- Surge Protection

EmersonNetworkPower.com

Emerson Network Power and the Emerson Network Power logo are trademarks and service marks of Emerson Electric Co. ©2008 Emerson Electric Co.

Looking for pricing, stock, or lifecycle information?

Click below to explore more details on WIN SOURCE:

-  [View PTH12050YAD on WIN SOURCE](#)
-  [Artesyn Embedded Technologies Information](#)

Optimize Your Supply Chain with WIN SOURCE Solutions

-  Global Sourcing Solution
-  Obsolete Management
-  Cost Control Management
-  Shortage Management
-  Alternative Solution
-  Excess Inventory Management