



**THE DATASHEET OF
VLF12060T-680M2R3**



SMD Inductors(Coils) For Power Line(Wound, Magnetic Shielded)

Conformity to RoHS Directive

VLF Series VLF12060

FEATURES

- Mount area: 11.7.0×12.0mm
Low profile: 6.0mm max. height
- Compare to SLF12565(TDK conventional product) type
Low loss and large current capability design
DC resistance: 0.88×SLF12565
Rated DC current: 1.43×SLF12565
- High magnetic shield construction should actualize high resolution for EMC protection.
- Available for automatic mounting in tape and reel package.
- The products contain no lead and also support lead-free soldering.
- It is a product conforming to RoHS directive.

APPLICATIONS

Note book computers, amusement equipment, DVD players, VRMs, plasma displays, etc.

SHAPES AND DIMENSIONS

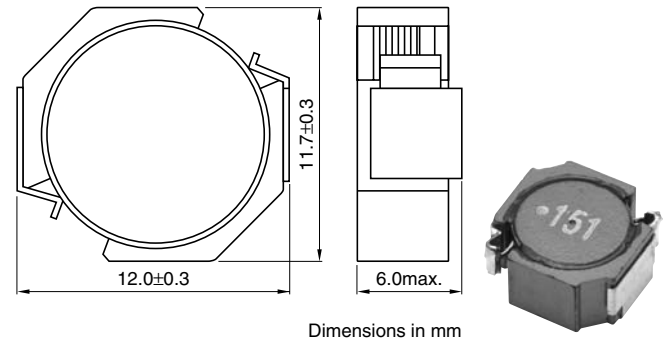

RECOMMENDED PC BOARD PATTERN

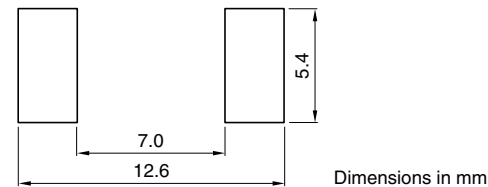

ELECTRICAL CHARACTERISTICS

Part No.	Inductance (μH)	Inductance tolerance(%)	Test frequency (kHz)	DC resistance(mΩ)		Rated current(A)*	
				max.	typ.	Based on inductance change max.	Based on temperature rise typ.
VLF12060T-1R8N120	1.8	±30	100	4.4	3.6	14.6	12
VLF12060T-2R7N100	2.7	±30	100	6.4	5.3	12	10
VLF12060T-3R9N9R0	3.9	±30	100	8.4	7.0	9.9	9
VLF12060T-4R7N7R7	4.7	±30	100	11.6	9.6	9.1	7.7
VLF12060T-6R8N7R2	6.8	±30	100	13.1	10.9	7.5	7.2
VLF12060T-100M6R2	10	±20	100	16	13.9	6.2	6.4
VLF12060T-150M5R0	15	±20	100	26	22.3	5.0	5.0
VLF12060T-220M4R1	22	±20	100	36	31.4	4.1	4.2
VLF12060T-330M3R4	33	±20	100	53	46.1	3.4	3.5
VLF12060T-470M2R8	47	±20	100	71	62.2	2.8	3.0
VLF12060T-680M2R3	68	±20	100	100	87.5	2.3	2.5
VLF12060T-101M1R9	100	±20	100	152	132.4	1.9	2.0
VLF12060T-151M1R6	150	±20	100	215	187.1	1.6	1.7
VLF12060T-221M1R3	220	±20	100	352	306.8	1.3	1.3
VLF12060T-331M1R0	330	±20	100	464	404	1.0	1.1

* Rated current: Value obtained when current flows and the temperature has risen to 40°C or when DC current flows and the nominal value of inductance has fallen by 30%, whichever is smaller.



- Operating temperature range: -40 to +105°C (Including self-temperature rise)

• Conformity to RoHS Directive: This means that, in conformity with EU Directive 2002/95/EC, lead, cadmium, mercury, hexavalent chromium, and specific bromine-based flame retardants, PBB and PBDE, have not been used, except for exempted applications.

• All specifications are subject to change without notice.

Looking for pricing, stock, or lifecycle information?

Click below to explore more details on WIN SOURCE:

-  [View VLF12060T-680M2R3 on WIN SOURCE](#)
-  [TDK Corporation](#) Information

Optimize Your Supply Chain with WIN SOURCE Solutions

-  Global Sourcing Solution
-  Obsolete Management
-  Cost Control Management
-  Shortage Management
-  Alternative Solution
-  Excess Inventory Management