



**THE DATASHEET OF  
AP2114H-1.2TRG1**



# 1A LOW NOISE CMOS LDO REGULATOR WITH ENABLE AP2114

## General Description

The AP2114 is CMOS process low dropout linear regulator with enable function, the regulator delivers a guaranteed 1A (Min) continuous load current.

The AP2114 features low power consumption.

The AP2114 is available in 1.2V, 1.5V, 1.8V, 2.5V and 3.3V regulator output and 0.8V to 5V adjustable output, and available in excellent output accuracy  $\pm 1.5\%$ , it is also available in an excellent load regulation and line regulation performance.

The AP2114 is available in standard packages of SOT-223, TO-252-2(1), TO-252-2(3), TO-252-2(4), TO-263-3, SOIC-8 and PSOP-8.

## Features

- Output Voltage Accuracy:  $\pm 1.5\%$
- Output Current: 1A (Min)
- Fold-back Short Current Protection: 50mA
- Low Dropout Voltage (3.3V): 450mV (Typ) @  $I_{OUT}=1A$
- Stable with 4.7 $\mu$ F Flexible Cap: Ceramic, Tantalum and Aluminum Electrolytic
- Excellent Line Regulation: 0.02%/V (Typ), 0.1%/V (Max) @  $I_{OUT}=30mA$
- Excellent Load Regulation: 0.2%A (Typ) @  $I_{OUT}=1mA$  to 1A
- Low Quiescent Current: 60 $\mu$ A (1.2V/1.5V/1.8V /2.5V/ADJ)
- Low Output Noise: 30 $\mu$ V<sub>RMS</sub>
- PSRR: 68dB @ Freq=1KHz(1.2V/1.5V/1.8V /ADJ)
- OTSD Protection
- Operating Temperature Range: -40°C to 85°C
- ESD: MM 400V, HBM 4000V

## Applications

- LCD Monitor
- LCD TV
- STB

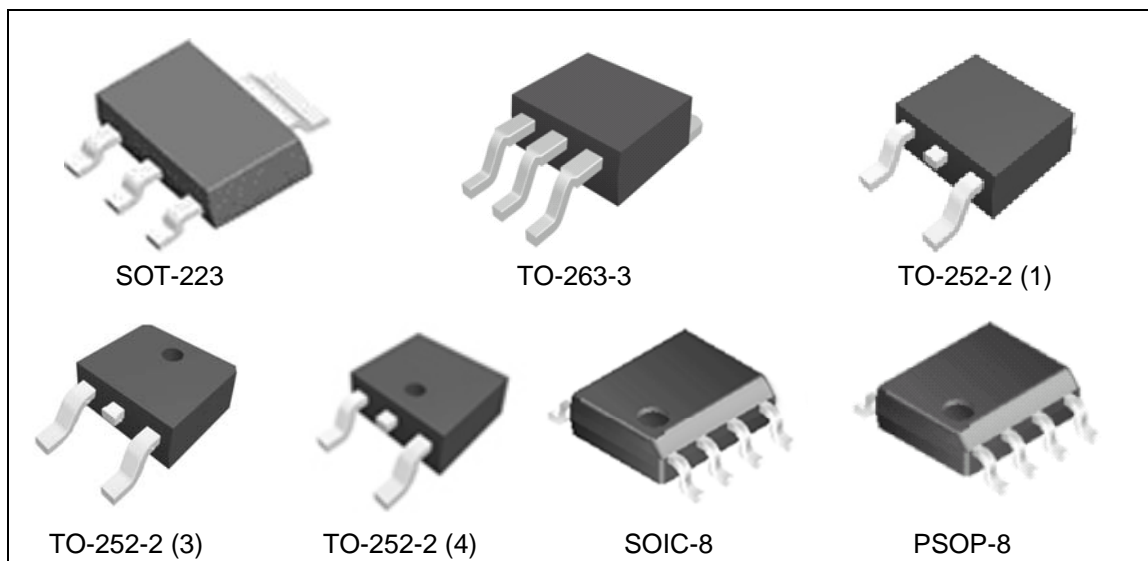

Figure 1. Package Types of AP2114

**1A LOW NOISE CMOS LDO REGULATOR WITH ENABLE AP2114**

**Pin Configuration**

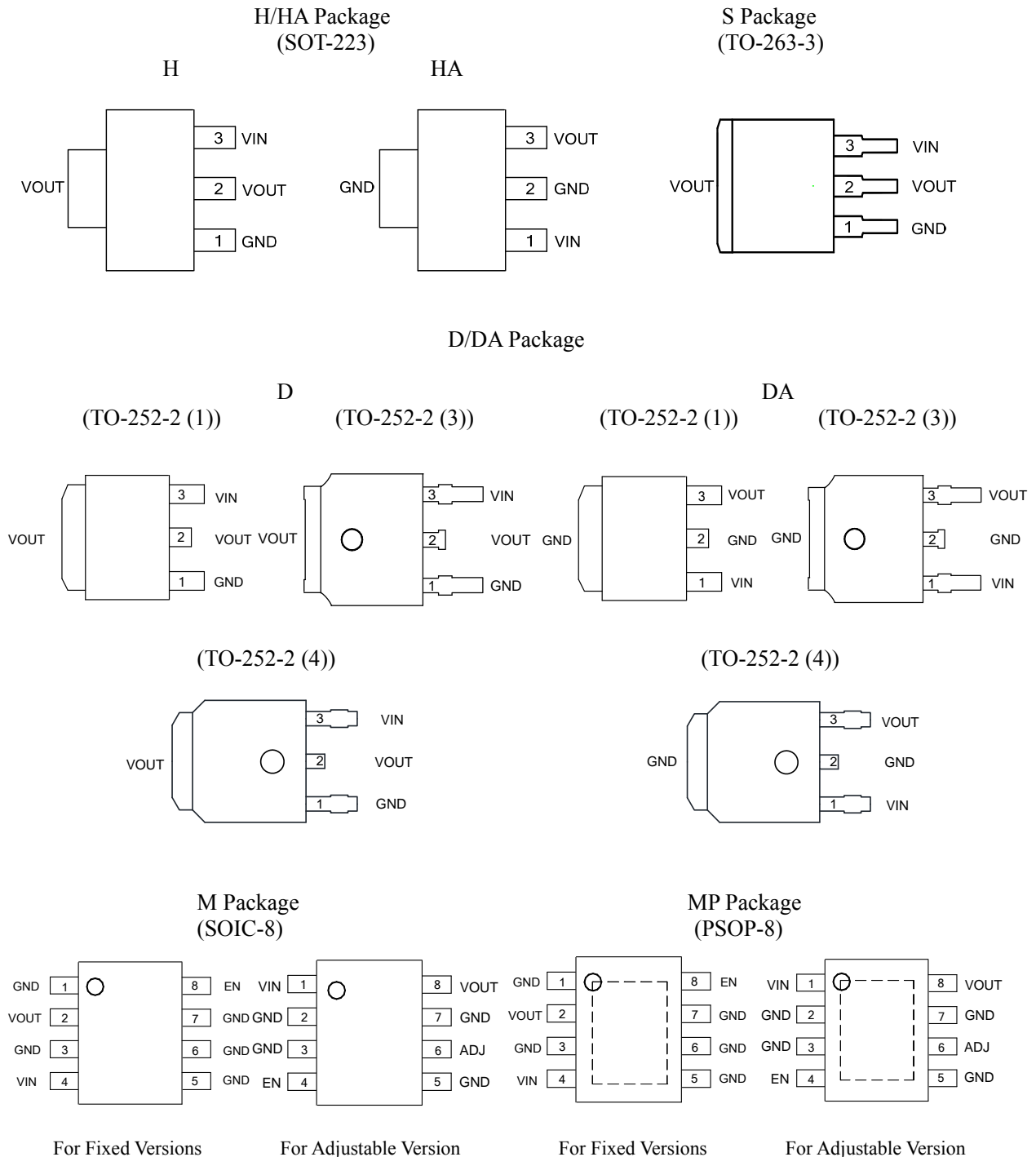

Figure 2. Pin Configuration of AP2114 (Top View)

# 1A LOW NOISE CMOS LDO REGULATOR WITH ENABLE AP2114

## Pin Descriptions

Pin Number				Pin Name	Function
SOT-223 (H), TO-263-3, TO-252-2 (1) (D) TO-252-2 (3) (D) TO-252-2 (4) (D)	SOT-223 (HA), TO-252-2 (1) (DA) TO-252-2 (3) (DA) TO-252-2 (4) (DA)	SOIC-8, PSOP-8 (Fixed)	SOIC-8, PSOP-8 (ADJ)		
1	2	1, 3, 5, 6, 7	2, 3, 5, 7	GND	Ground
2	3	2	8	VOUT	Regulated Output
3	1	4	1	VIN	Input Voltage Pin
		8	4	EN	Chip Enable, H-Normal Work, L- Shutdown Output
			6	ADJ	Adjust Output

## Functional Block Diagram

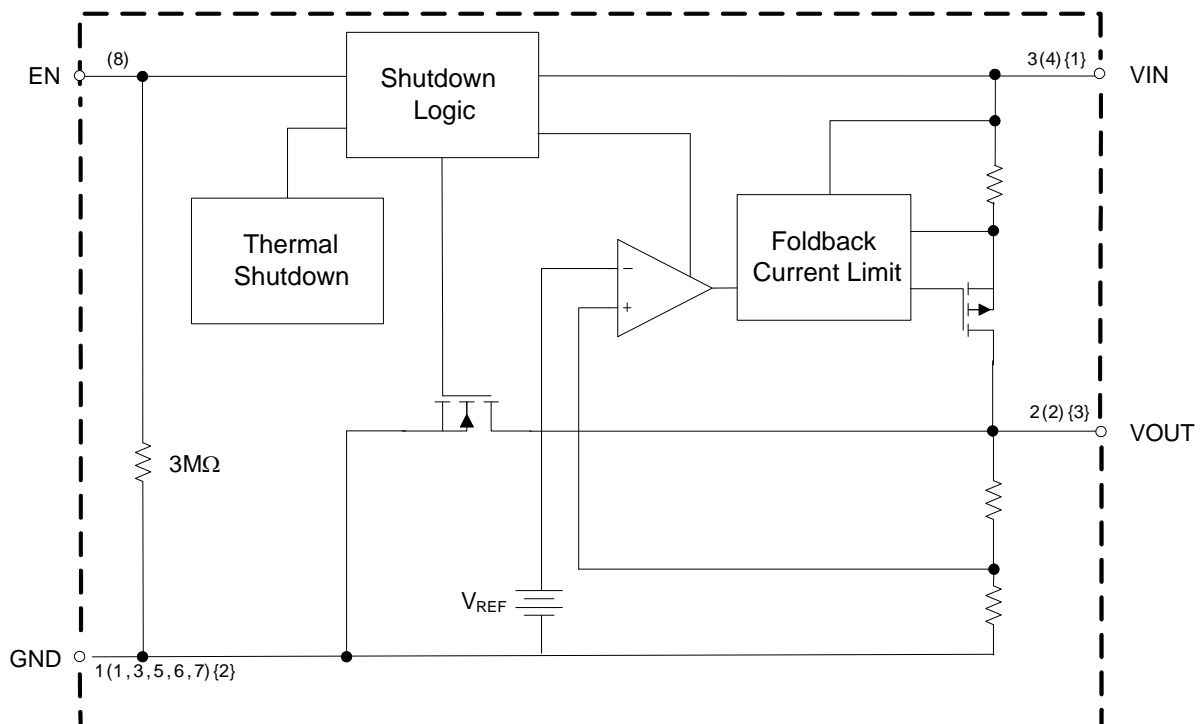

A(B){C}  
 A: SOT-223(H), TO-263-3, TO-252-2(1)/(3)/(4)(D)  
 B: SOIC-8, PSOP-8  
 C: SOT-223 (HA), TO-252-2(1)/(3)/(4)(DA)

For Fixed Versions

**1A LOW NOISE CMOS LDO REGULATOR WITH ENABLE AP2114**

**Functional Block Diagram (Continued)**

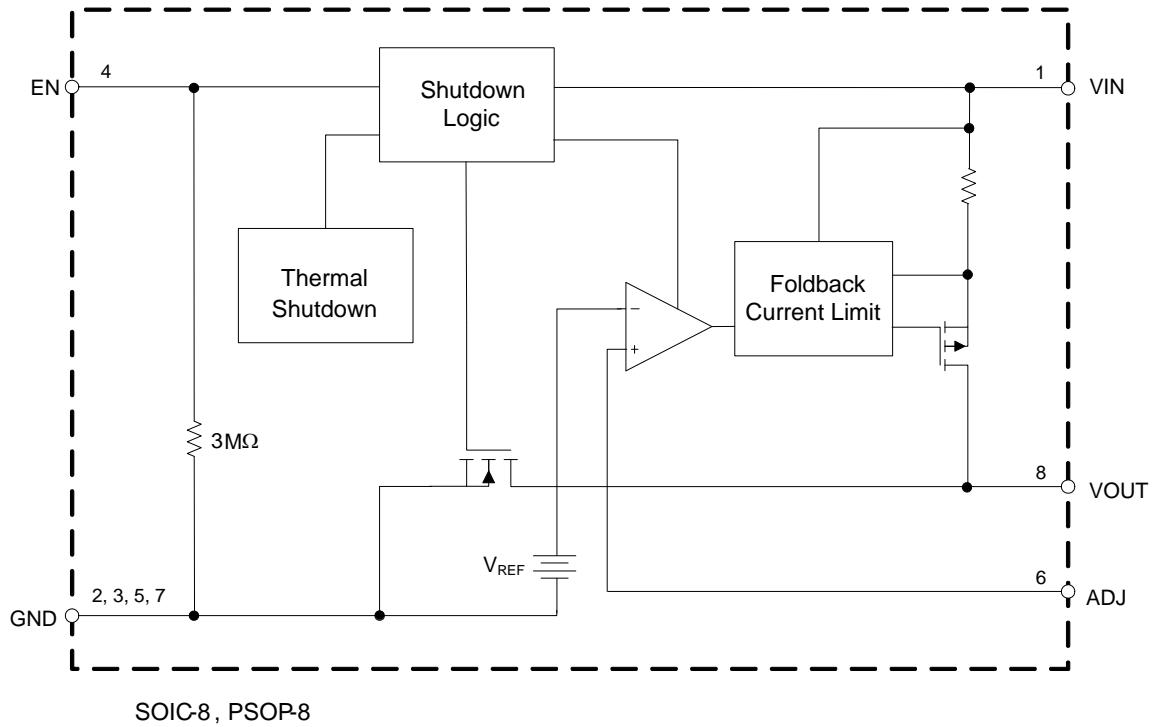

For ADJ Version

Figure 3. Functional Block Diagram of AP2114

**1A LOW NOISE CMOS LDO REGULATOR WITH ENABLE AP2114**

**Ordering Information**

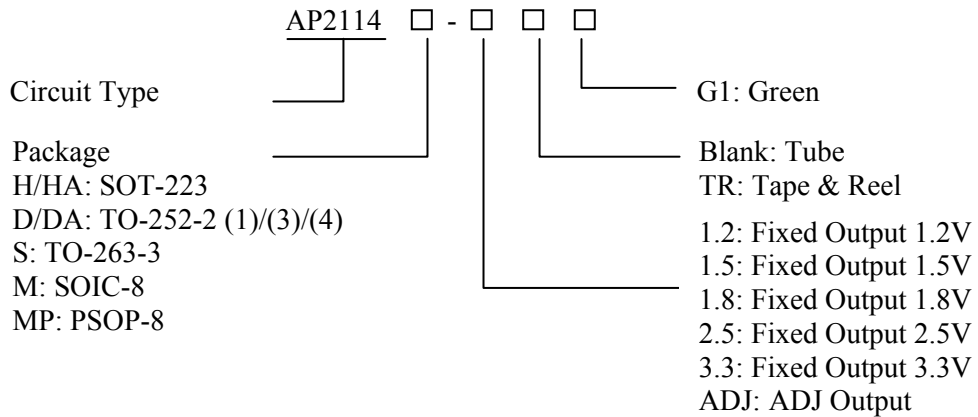

Package	Temperature Range	Output Voltage	Part Number	Marking ID	Packing Type
SOT-223	-40 to 85°C	1.2V (H)	AP2114H-1.2TRG1	GH12C	Tape & Reel
		1.5V (H)	AP2114H-1.5TRG1	GH16G	Tape & Reel
		1.8V (H)	AP2114H-1.8TRG1	GH12D	Tape & Reel
		2.5V (H)	AP2114H-2.5TRG1	GH14C	Tape & Reel
		3.3V (H)	AP2114H-3.3TRG1	GH12E	Tape & Reel
SOT-223	-40 to 85°C	1.2V (HA)	AP2114HA-1.2TRG1	GH13B	Tape & Reel
		1.5V (HA)	AP2114HA-1.5TRG1	GH16H	Tape & Reel
		1.8V (HA)	AP2114HA-1.8TRG1	GH14D	Tape & Reel
		2.5V (HA)	AP2114HA-2.5TRG1	GH14E	Tape & Reel
		3.3V (HA)	AP2114HA-3.3TRG1	GH14F	Tape & Reel
TO-252-2 (1)/ TO-252-2 (3)/ TO-252-2 (4)	-40 to 85°C	1.2V (D)	AP2114D-1.2TRG1	AP2114D-1.2G1	Tape & Reel
		1.5V (D)	AP2114D-1.5TRG1	AP2114D-1.5G1	Tape & Reel
		1.8V (D)	AP2114D-1.8TRG1	AP2114D-1.8G1	Tape & Reel
		2.5V (D)	AP2114D-2.5TRG1	AP2114D-2.5G1	Tape & Reel
		3.3V (D)	AP2114D-3.3TRG1	AP2114D-3.3G1	Tape & Reel
TO-252-2 (1)/ TO-252-2 (3)/ TO-252-2 (4)	-40 to 85°C	1.2V (DA)	AP2114DA-1.2TRG1	AP2114DA-1.2G1	Tape & Reel
		1.5V (DA)	AP2114DA-1.5TRG1	AP2114DA-1.5G1	Tape & Reel
		1.8V (DA)	AP2114DA-1.8TRG1	AP2114DA-1.8G1	Tape & Reel
		2.5V (DA)	AP2114DA-2.5TRG1	AP2114DA-2.5G1	Tape & Reel
		3.3V (DA)	AP2114DA-3.3TRG1	AP2114DA-3.3G1	Tape & Reel
TO-263-3	-40 to 85°C	1.2V	AP2114S-1.2TRG1	AP2114S-1.2G1	Tape & Reel
		1.5V	AP2114S-1.5TRG1	AP2114S-1.5G1	Tape & Reel
		1.8V	AP2114S-1.8TRG1	AP2114S-1.8G1	Tape & Reel
		2.5V	AP2114S-2.5TRG1	AP2114S-2.5G1	Tape & Reel
		3.3V	AP2114S-3.3TRG1	AP2114S-3.3G1	Tape & Reel
SOIC-8	-40 to 85°C	1.2V	AP2114M-1.2TRG1	2114M-1.2G1	Tape & Reel
		1.5V	AP2114M-1.5TRG1	2114M-1.5G1	Tape & Reel
		1.8V	AP2114M-1.8TRG1	2114M-1.8G1	Tape & Reel
		2.5V	AP2114M-2.5TRG1	2114M-2.5G1	Tape & Reel
		3.3V	AP2114M-3.3TRG1	2114M-3.3G1	Tape & Reel
		ADJ	AP2114M-ADJG1	2114M-ADJG1	Tube
		AP2114M-ADJTRG1	2114M-ADJG1	Tape & Reel	

**1A LOW NOISE CMOS LDO REGULATOR WITH ENABLE AP2114****Ordering Information (Continued)**

Package	Temperature Range	Output Voltage	Part Number	Marking ID	Packing Type
PSOP-8	-40 to 85°C	1.2V	AP2114MP-1.2TRG1	2114MP-1.2G1	Tape & Reel
		1.5V	AP2114MP-1.5TRG1	2114MP-1.5G1	Tape & Reel
		1.8V	AP2114MP-1.8TRG1	2114MP-1.8G1	Tape & Reel
		2.5V	AP2114MP-2.5TRG1	2114MP-2.5G1	Tape & Reel
		3.3V	AP2114MP-3.3TRG1	2114MP-3.3G1	Tape & Reel
		ADJ	AP2114MP-ADJG1	2114MP-ADJG1	Tube
			AP2114MP-ADJTRG1	2114MP-ADJG1	Tape & Reel

BCD Semiconductor's Pb-free products, as designated with "G1" suffix in the part number, are RoHS compliant and Green.

**1A LOW NOISE CMOS LDO REGULATOR WITH ENABLE AP2114****Absolute Maximum Ratings (Note 1)**

Parameter	Symbol	Value		Unit
Power Supply Voltage	$V_{IN}$	6.5		V
Operating Junction Temperature Range	$T_J$	150		°C
Storage Temperature Range	$T_{STG}$	-65 to 150		°C
Lead Temperature (Soldering, 10sec)	$T_{LEAD}$	260		°C
Thermal Resistance (Junction to Ambient) (No Heatsink)	$\theta_{JA}$	SOIC-8	144	°C/W
		PSOP-8	143	
		SOT-223	128	
		TO-252-2 (1)/ TO-252-2 (3)/ TO-252-2 (4)	90	
		TO-263-3	73	
ESD (Machine Model)		400		V
ESD (Human Body Model)		4000		V

Note 1: Stresses greater than those listed under “Absolute Maximum Ratings” may cause permanent damage to the device. These are stress ratings only, and functional operation of the device at these or any other conditions beyond those indicated under “Recommended Operating Conditions” is not implied. Exposure to “Absolute Maximum Ratings” for extended periods may affect device reliability.

**Recommended Operating Conditions**

Parameter	Symbol	Min	Max	Unit
Supply Voltage	$V_{IN}$	2.5	6.0	V
Operating Ambient Temperature Range	$T_A$	-40	85	°C



**1A LOW NOISE CMOS LDO REGULATOR WITH ENABLE AP2114**

**Electrical Characteristics**

**AP2114-1.2 Electrical Characteristics (Note 2)**

( $V_{IN}=2.5V$ ,  $C_{IN}=4.7\mu F$  (Ceramic),  $C_{OUT}=4.7\mu F$  (Ceramic), Typical  $T_A=25^\circ C$ , **Bold** typeface applies over  $-40^\circ C \leq T_A \leq 85^\circ C$  ranges, unless otherwise specified (Note 3))

Parameter	Symbol	Test Conditions	Min	Typ	Max	Unit
Output Voltage	$V_{OUT}$	$V_{IN}=2.5V$ , $1mA \leq I_{OUT} \leq 30mA$	$\frac{V_{OUT}}{\times 98.5\%}$	1.2	$\frac{V_{OUT}}{\times 101.5\%}$	V
Input Voltage	$V_{IN}$				6.0	V
Maximum Output Current	$I_{OUT(MAX)}$	$V_{IN}=2.5V$ , $V_{OUT}=1.182V$ to $1.218V$	1			A
Load Regulation	$\frac{\Delta V_{OUT}/V_{OUT}}{\Delta I_{OUT}}$	$V_{IN}=2.5V$ , $1mA \leq I_{OUT} \leq 1A$		0.2	1	%/A
Line Regulation	$\frac{\Delta V_{OUT}/V_{OUT}}{\Delta V_{IN}}$	$2.5V \leq V_{IN} \leq 6V$ , $I_{OUT}=30mA$	-0.1	0.02	0.1	%/V
Dropout Voltage	$V_{DROP}$	$I_{OUT}=1.0A$		1200	1300	mV
Quiescent Current	$I_Q$	$V_{IN}=2.5V$ , $I_{OUT}=0mA$		60	75	$\mu A$
Power Supply Rejection Ratio	PSRR	Ripple 1Vp-p $V_{IN}=2.5V$ , $I_{OUT}=100mA$	$f=100Hz$	68		dB
			$f=1KHz$	68		
Output Voltage Temperature Coefficient	$\frac{\Delta V_{OUT}/V_{OUT}}{\Delta T}$	$I_{OUT}=30mA$ , $T_A = -40^\circ C$ to $85^\circ C$		<b><math>\pm 30</math></b>		ppm/ $^\circ C$
Short Current Limit	$I_{SHORT}$	$V_{OUT}=0V$		50		mA
RMS Output Noise	$V_{NOISE}$	$10Hz \leq f \leq 100kHz$ (No Load)		30		$\mu V_{RMS}$
$V_{EN}$ High Voltage	$V_{IH}$	Enable logic high, regulator on	1.5			V
$V_{EN}$ Low Voltage	$V_{IL}$	Enable logic low, regulator off			0.4	
Standby Current	$I_{STD}$	$V_{IN}=2.5V$ , $V_{EN}$ in OFF mode		0.01	1.0	$\mu A$
Start-up Time	$t_s$	No Load		20		$\mu s$
EN Pull Down Resistor	$R_{PD}$			3.0		M $\Omega$
$V_{OUT}$ Discharge Resistor	$R_{DCHG}$	Set EN pin at Low		60		$\Omega$
Thermal Shutdown Temperature	$T_{OTSD}$			160		$^\circ C$
Thermal Shutdown Hysteresis	$T_{HYOTSD}$			25		
Thermal Resistance (Junction to Case)	$\theta_{JC}$	SOIC-8		74.6		$^\circ C/W$
		PSOP-8		43.7		
		SOT-223		50.9		
		TO-252-2 (1)/(3)/(4)		35		
		TO-263-3		22		

Note 2: To prevent the Short Circuit Current protection feature from being prematurely activated, the input voltage must be applied before a current source load is applied.

Note 3: Production testing at  $T_A=25^\circ C$ . Over temperature specifications guaranteed by design only.



**1A LOW NOISE CMOS LDO REGULATOR WITH ENABLE AP2114**

**Electrical Characteristics (Continued)**

**AP2114-1.5 Electrical Characteristics (Note 2)**

( $V_{IN}=2.5V$ ,  $C_{IN}=4.7\mu F$  (Ceramic),  $C_{OUT}=4.7\mu F$  (Ceramic), Typical  $T_A=25^\circ C$ , **Bold** typeface applies over  $-40^\circ C \leq T_A \leq 85^\circ C$  ranges, unless otherwise specified (Note 3))

Parameter	Symbol	Test Conditions	Min	Typ	Max	Unit
Output Voltage	$V_{OUT}$	$V_{IN}=2.5V$ , $1mA \leq I_{OUT} \leq 30mA$	$\frac{V_{OUT}}{\times 98.5\%}$	1.5	$\frac{V_{OUT}}{\times 101.5\%}$	V
Input Voltage	$V_{IN}$				6.0	V
Maximum Output Current	$I_{OUT(MAX)}$	$V_{IN}=2.5V$ , $V_{OUT}=1.478V$ to $1.523V$	1			A
Load Regulation	$\frac{\Delta V_{OUT}/V_{OUT}}{\Delta I_{OUT}}$	$V_{IN}=2.5V$ , $1mA \leq I_{OUT} \leq 1A$		0.2	1	%/A
Line Regulation	$\frac{\Delta V_{OUT}/V_{OUT}}{\Delta V_{IN}}$	$2.5V \leq V_{IN} \leq 6V$ , $I_{OUT}=30mA$	-0.1	0.02	0.1	%/V
Dropout Voltage	$V_{DROP}$	$I_{OUT}=1.0A$		800	1000	mV
Quiescent Current	$I_Q$	$V_{IN}=2.5V$ , $I_{OUT}=0mA$		60	75	$\mu A$
Power Supply Rejection Ratio	PSRR	Ripple 1Vp-p $V_{IN}=2.5V$ , $I_{OUT}=100mA$	$f=100Hz$	68		dB
			$f=1KHz$	68		
Output Voltage Temperature Coefficient	$\frac{\Delta V_{OUT}/V_{OUT}}{\Delta T}$	$I_{OUT}=30mA$ , $T_A = -40^\circ C$ to $85^\circ C$		<b><math>\pm 30</math></b>		ppm/ $^\circ C$
Short Current Limit	$I_{SHORT}$	$V_{OUT}=0V$		50		mA
RMS Output Noise	$V_{NOISE}$	$10Hz \leq f \leq 100kHz$ (No Load)		30		$\mu V_{RMS}$
$V_{EN}$ High Voltage	$V_{IH}$	Enable logic high, regulator on	1.5			V
$V_{EN}$ Low Voltage	$V_{IL}$	Enable logic low, regulator off			0.4	
Standby Current	$I_{STD}$	$V_{IN}=2.5V$ , $V_{EN}$ in OFF mode		0.01	1.0	$\mu A$
Start-up Time	$t_s$	No Load		20		$\mu s$
EN Pull Down Resistor	$R_{PD}$			3.0		M $\Omega$
$V_{OUT}$ Discharge Resistor	$R_{DCHG}$	Set EN pin at Low		60		$\Omega$
Thermal Shutdown Temperature	$T_{OTSD}$			160		$^\circ C$
Thermal Shutdown Hysteresis	$T_{HYOTSD}$			25		
Thermal Resistance (Junction to Case)	$\theta_{JC}$	SOIC-8		74.6		$^\circ C/W$
		PSOP-8		43.7		
		SOT-223		50.9		
		TO-252-2 (1)/(3)/(4)		35		
		TO-263-3		22		

Note 2: To prevent the Short Circuit Current protection feature from being prematurely activated, the input voltage must be applied before a current source load is applied.

Note 3: Production testing at  $T_A=25^\circ C$ . Over temperature specifications guaranteed by design only.



**1A LOW NOISE CMOS LDO REGULATOR WITH ENABLE AP2114**

**Electrical Characteristics (Continued)**

**AP2114-1.8 Electrical Characteristics (Note 2)**

( $V_{IN}=2.8V$ ,  $C_{IN}=4.7\mu F$  (Ceramic),  $C_{OUT}=4.7\mu F$  (Ceramic), Typical  $T_A=25^\circ C$ , **Bold** typeface applies over  $-40^\circ C \leq T_A \leq 85^\circ C$  ranges, unless otherwise specified (Note 3))

Parameter	Symbol	Test Conditions	Min	Typ	Max	Unit
Output Voltage	$V_{OUT}$	$V_{IN}=2.8V$ , $1mA \leq I_{OUT} \leq 30mA$	$V_{OUT} \times 98.5\%$	1.8	$V_{OUT} \times 101.5\%$	V
Maximum Output Current	$I_{OUT(MAX)}$	$V_{IN}=2.8V$ , $V_{OUT}=1.773V$ to $1.827V$	1.0			A
Load Regulation	$\frac{\Delta V_{OUT}/V_{OUT}}{\Delta I_{OUT}}$	$V_{IN}=2.8V$ , $1mA \leq I_{OUT} \leq 1A$		0.2	1.0	%/A
Line Regulation	$\frac{\Delta V_{OUT}/V_{OUT}}{\Delta V_{IN}}$	$2.8V \leq V_{IN} \leq 6V$ , $I_{OUT}=30mA$	-0.1	0.02	0.1	%/V
Dropout Voltage	$V_{DROP}$	$I_{OUT}=1.0A$		500	700	mV
Quiescent Current	$I_Q$	$V_{IN}=2.8V$ , $I_{OUT}=0mA$		60	75	$\mu A$
Power Supply Rejection Ratio	PSRR	Ripple 1Vp-p $V_{IN}=2.8V$ , $I_{OUT}=100mA$	$f=100Hz$		68	dB
			$f=1KHz$		68	
Output Voltage Temperature Coefficient	$\frac{\Delta V_{OUT}/V_{OUT}}{\Delta T}$	$I_{OUT}=30mA$ , $T_A = -40^\circ C$ to $85^\circ C$		<b><math>\pm 30</math></b>		ppm/ $^\circ C$
Short Current Limit	$I_{SHORT}$	$V_{OUT}=0V$		50		mA
RMS Output Noise	$V_{NOISE}$	$10Hz \leq f \leq 100kHz$ (No load)		30		$\mu V_{RMS}$
$V_{EN}$ High Voltage	$V_{IH}$	Enable logic high, regulator on	1.5			V
$V_{EN}$ Low Voltage	$V_{IL}$	Enable logic low, regulator off			0.4	
Standby Current	$I_{STD}$	$V_{IN}=2.8V$ , $V_{EN}$ in OFF mode		0.01	1.0	$\mu A$
Start-up Time	$t_S$	No Load		20		$\mu s$
EN Pull Down Resistor	$R_{PD}$			3.0		M $\Omega$
$V_{OUT}$ Discharge Resistor	$R_{DCHG}$	Set EN pin at Low		60		$\Omega$
Thermal Shutdown Temperature	$T_{OTSD}$			160		$^\circ C$
Thermal Shutdown Hysteresis	$T_{HYOTSD}$			25		
Thermal Resistance (Junction to Case)	$\theta_{JC}$	SOIC-8		74.6		$^\circ C / W$
		PSOP-8		43.7		
		SOT-223		50.9		
		TO-252-2 (1)/(3)/(4)		35		
		TO-263-3		22		

Note 2: To prevent the Short Circuit Current protection feature from being prematurely activated, the input voltage must be applied before a current source load is applied.

Note 3: Production testing at  $T_A=25^\circ C$ . Over temperature specifications guaranteed by design only.



**1A LOW NOISE CMOS LDO REGULATOR WITH ENABLE AP2114**

**Electrical Characteristics (Continued)**

**AP2114-2.5 Electrical Characteristics (Note 2)**

( $V_{IN}=3.5V$ ,  $C_{IN}=4.7\mu F$  (Ceramic),  $C_{OUT}=4.7\mu F$  (Ceramic), Typical  $T_A=25^\circ C$ , **Bold** typeface applies over  $-40^\circ C \leq T_A \leq 85^\circ C$  ranges, unless otherwise specified (Note 3))

Parameter	Symbol	Test Conditions	Min	Typ	Max	Unit
Output Voltage	$V_{OUT}$	$V_{IN}=3.5V$ , $1mA \leq I_{OUT} \leq 30mA$	$V_{OUT} \times 98.5\%$	2.5	$V_{OUT} \times 101.5\%$	V
Maximum Output Current	$I_{OUT(MAX)}$	$V_{IN}=3.5V$ , $V_{OUT}=2.463V$ to $2.537V$	1.0			A
Load Regulation	$\frac{\Delta V_{OUT}/V_{OUT}}{\Delta I_{OUT}}$	$V_{out}=2.5V$ , $V_{IN}=V_{out}+1V$ $1mA \leq I_{OUT} \leq 1A$		0.2	1.0	%/A
Line Regulation	$\frac{\Delta V_{OUT}/V_{OUT}}{\Delta V_{IN}}$	$3.5V \leq V_{IN} \leq 6V$ , $I_{OUT}=30mA$	-0.1	0.02	0.1	%/V
Dropout Voltage	$V_{DROP}$	$I_{OUT}=1A$		450	750	mV
Quiescent Current	$I_Q$	$V_{IN}=3.5V$ , $I_{OUT}=0mA$		60	80	$\mu A$
Power Supply Rejection Ratio	PSRR	Ripple 1Vp-p $V_{IN}=3.5V$ , $I_{OUT}=100mA$	$f=100Hz$	65		dB
			$f=1KHz$	65		
Output Voltage Temperature Coefficient	$\frac{\Delta V_{OUT}/V_{OUT}}{\Delta T}$	$I_{OUT}=30mA$		<b><math>\pm 30</math></b>		ppm/ $^\circ C$
Short Current Limit	$I_{SHORT}$	$V_{OUT}=0V$		50		mA
RMS Output Noise	$V_{NOISE}$	$10Hz \leq f \leq 100kHz$		30		$\mu V_{RMS}$
$V_{EN}$ High Voltage	$V_{IH}$	Enable logic high, regulator on	1.5			V
$V_{EN}$ Low Voltage	$V_{IL}$	Enable logic low, regulator off			0.4	
Standby Current	$I_{STD}$	$V_{IN}=3.5V$ , $V_{EN}$ in OFF mode		0.01	1.0	$\mu A$
Start-up Time	$t_s$	No Load		20		$\mu s$
EN Pull Down Resistor	$R_{PD}$			3.0		M $\Omega$
$V_{OUT}$ Discharge Resistor	$R_{DCHG}$	Set EN pin at Low		60		$\Omega$
Thermal Shutdown Temperature	$T_{OTSD}$			160		$^\circ C$
Thermal Shutdown Hysteresis	$T_{HYOTSD}$			25		
Thermal Resistance (Junction to Case)	$\theta_{JC}$	SOIC-8		74.6		$^\circ C/W$
		PSOP-8		43.7		
		SOT-223		50.9		
		TO-252-2 (1)/(3)/(4)		35		
		TO-263-3		22		

Note 2: To prevent the Short Circuit Current protection feature from being prematurely activated, the input voltage must be applied before a current source load is applied.

Note 3: Production testing at  $T_A=25^\circ C$ . Over temperature specifications guaranteed by design only.



**1A LOW NOISE CMOS LDO REGULATOR WITH ENABLE AP2114**

**Electrical Characteristics (Continued)**

**AP2114-3.3 Electrical Characteristics (Note 2)**

( $V_{IN}=4.3V$ ,  $C_{IN}=4.7\mu F$  (Ceramic),  $C_{OUT}=4.7\mu F$  (Ceramic), Typical  $T_A=25^\circ C$ , **Bold** typeface applies over  $-40^\circ C \leq T_A \leq 85^\circ C$  ranges, unless otherwise specified (Note 3))

Parameter	Symbol	Test Conditions	Min	Typ	Max	Unit
Output Voltage	$V_{OUT}$	$V_{IN}=4.3V$ , $1mA \leq I_{OUT} \leq 30mA$	$V_{OUT} \times 98.5\%$	3.3	$V_{OUT} \times 101.5\%$	V
Maximum Output Current	$I_{OUT(MAX)}$	$V_{IN}=4.3V$ , $V_{OUT}=3.25V$ to $3.35V$	1.0			A
Load Regulation	$\frac{\Delta V_{OUT}/V_{OUT}}{\Delta I_{OUT}}$	$V_{IN}=4.3V$ , $1mA \leq I_{OUT} \leq 1A$		0.2	1.0	%/A
Line Regulation	$\frac{\Delta V_{OUT}/V_{OUT}}{\Delta V_{IN}}$	$4.3V \leq V_{IN} \leq 6V$ , $I_{OUT}=30mA$	-0.1	0.02	0.1	%/V
Dropout Voltage	$V_{DROP}$	$I_{OUT}=1A$		450	750	mV
Quiescent Current	$I_Q$	$V_{IN}=4.3V$ , $I_{OUT}=0mA$		65	90	$\mu A$
Power Supply Rejection Ratio	PSRR	Ripple 1Vp-p $V_{IN}=4.3V$ , $I_{OUT}=100mA$	$f=100Hz$		65	dB
			$f=1KHz$		65	
Output Voltage Temperature Coefficient	$\frac{\Delta V_{OUT}/V_{OUT}}{\Delta T}$	$I_{OUT}=30mA$		<b><math>\pm 30</math></b>		ppm/ $^\circ C$
Short Current Limit	$I_{SHORT}$	$V_{OUT}=0V$		50		mA
RMS Output Noise	$V_{NOISE}$	$10Hz \leq f \leq 100kHz$ (No load)		30		$\mu V_{RMS}$
$V_{EN}$ High Voltage	$V_{IH}$	Enable logic high, regulator on	1.5			V
$V_{EN}$ Low Voltage	$V_{IL}$	Enable logic low, regulator off			0.4	
Standby Current	$I_{STD}$	$V_{IN}=4.3V$ , $V_{EN}$ in OFF mode		0.01	1.0	$\mu A$
Start-up Time	$t_s$	No Load		20		$\mu s$
EN Pull Down Resistor	$R_{PD}$			3.0		M $\Omega$
$V_{OUT}$ Discharge Resistor	$R_{DCHG}$	Set EN pin at Low		60		$\Omega$
Thermal Shutdown Temperature	$T_{OTSD}$			160		$^\circ C$
Thermal Shutdown Hysteresis	$T_{HYOTSD}$			25		
Thermal Resistance (Junction to Case)	$\theta_{JC}$	SOIC-8		74.6		$^\circ C/W$
		PSOP-8		43.7		
		SOT-223		50.9		
		TO-252-2 (1)/(3)/(4)		35		
		TO-263-3		22		

Note 2: To prevent the Short Circuit Current protection feature from being prematurely activated, the input voltage must be applied before a current source load is applied.

Note 3: Production testing at  $T_A=25^\circ C$ . Over temperature specifications guaranteed by design only.



**1A LOW NOISE CMOS LDO REGULATOR WITH ENABLE AP2114**

**Electrical Characteristics (Continued)**

**AP2114-ADJ Electrical Characteristics (Note 2)**

( $V_{IN}=2.5V$ ,  $C_{IN}=4.7\mu F$  (Ceramic),  $C_{OUT}=4.7\mu F$  (Ceramic), Typical  $T_A=25^\circ C$ , **Bold** typeface applies over  $-40^\circ C \leq T_A \leq 85^\circ C$  ranges, unless otherwise specified (Note 3))

Parameter	Symbol	Test Conditions	Min	Typ	Max	Unit
Reference Voltage	$V_{REF}$	$V_{IN}=2.5V$ , $1mA \leq I_{OUT} \leq 30mA$	$\frac{V_{REF}}{\times 98.5\%}$	0.8	$\frac{V_{REF}}{\times 101.5\%}$	V
Input Voltage	$V_{IN}$				6.0	V
Maximum Output Current	$I_{OUT(MAX)}$	$V_{IN}=2.5V$ , $V_{OUT}=0.788V$ to $0.812V$	1			A
Load Regulation	$\frac{\Delta V_{OUT}/V_{OUT}}{\Delta I_{OUT}}$	$V_{IN}=2.5V$ , $1mA \leq I_{OUT} \leq 1A$		0.2	1	%/A
Line Regulation	$\frac{\Delta V_{OUT}/V_{OUT}}{\Delta V_{IN}}$	$2.5V \leq V_{IN} \leq 6V$ , $I_{OUT}=30mA$	-0.1	0.02	0.1	%/V
Quiescent Current	$I_Q$	$V_{IN}=2.5V$ , $I_{OUT}=0mA$		60	75	$\mu A$
Power Supply Rejection Ratio	PSRR	Ripple 1Vp-p $V_{IN}=2.5V$ , $I_{OUT}=100mA$	$f=100Hz$		68	dB
			$f=1KHz$		68	
Output Voltage Temperature Coefficient	$\frac{\Delta V_{OUT}/V_{OUT}}{\Delta T}$	$I_{OUT}=30mA$ , $T_A = -40^\circ C$ to $85^\circ C$		<b><math>\pm 30</math></b>		ppm/ $^\circ C$
Short Current Limit	$I_{SHORT}$	$V_{OUT}=0V$		50		mA
RMS Output Noise	$V_{NOISE}$	$10Hz \leq f \leq 100kHz$ (No Load)		30		$\mu V_{RMS}$
$V_{EN}$ High Voltage	$V_{IH}$	Enable logic high, regulator on	1.5			V
$V_{EN}$ Low Voltage	$V_{IL}$	Enable logic low, regulator off			0.4	
Standby Current	$I_{STD}$	$V_{IN}=2.5V$ , $V_{EN}$ in OFF mode		0.01	1.0	$\mu A$
Start-up Time	$t_s$	No Load		20		$\mu s$
EN Pull Down Resistor	$R_{PD}$			3.0		M $\Omega$
$V_{OUT}$ Discharge Resistor	$R_{DCHG}$	Set EN pin at Low		60		$\Omega$
Thermal Shutdown Temperature	$T_{OTSD}$			160		$^\circ C$
Thermal Shutdown Hysteresis	$T_{HYOTSD}$			25		
Thermal Resistance (Junction to Case)	$\theta_{JC}$	SOIC-8		74.6		$^\circ C/W$
		PSOP-8		43.7		

Note 2: To prevent the Short Circuit Current protection feature from being prematurely activated, the input voltage must be applied before a current source load is applied.

Note 3: Production testing at  $T_A=25^\circ C$ . Over temperature specifications guaranteed by design only.

**1A LOW NOISE CMOS LDO REGULATOR WITH ENABLE AP2114**

**Typical Performance Characteristics**

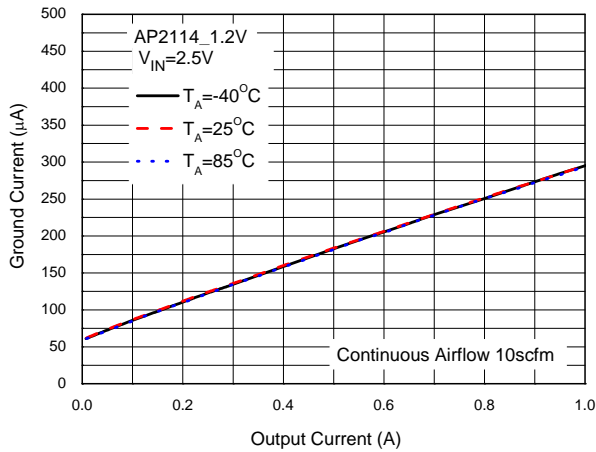

Figure 4. Ground Current vs. Output Current

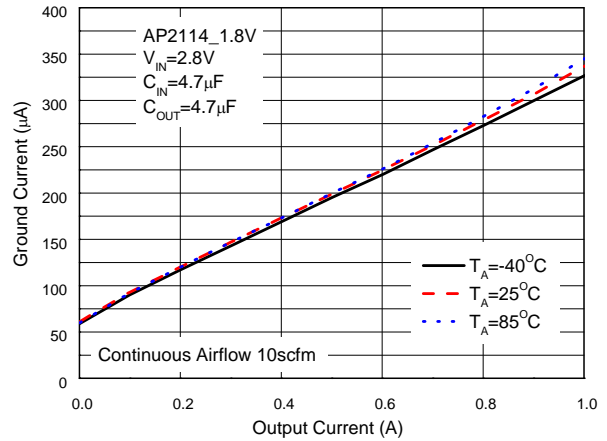

Figure 5. Ground Current vs. Output Current

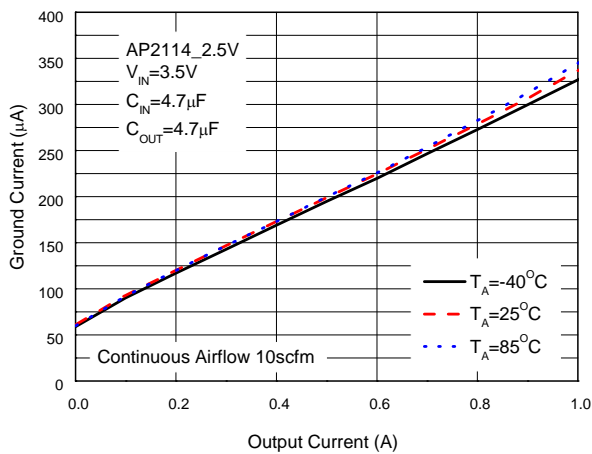

Figure 6. Ground Current vs. Output Current

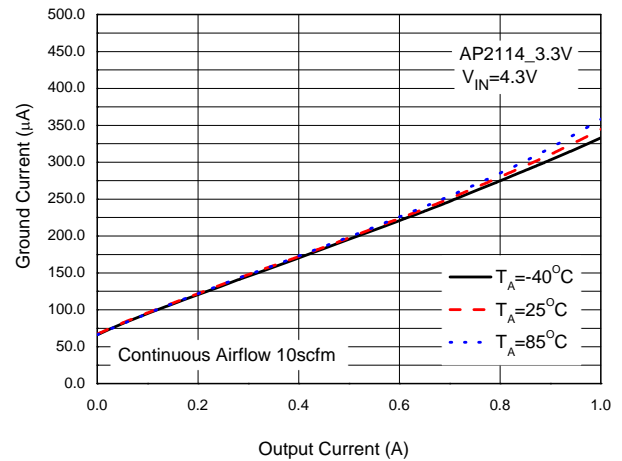

Figure 7. Ground Current vs. Output Current

**1A LOW NOISE CMOS LDO REGULATOR WITH ENABLE AP2114**

**Typical Performance Characteristics (Continued)**

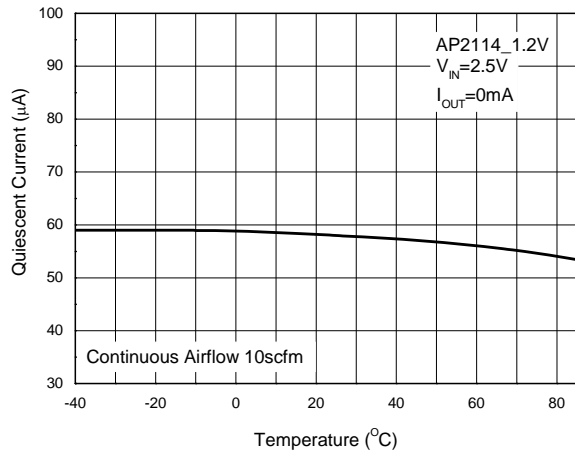

Figure 8. Quiescent Current vs. Temperature

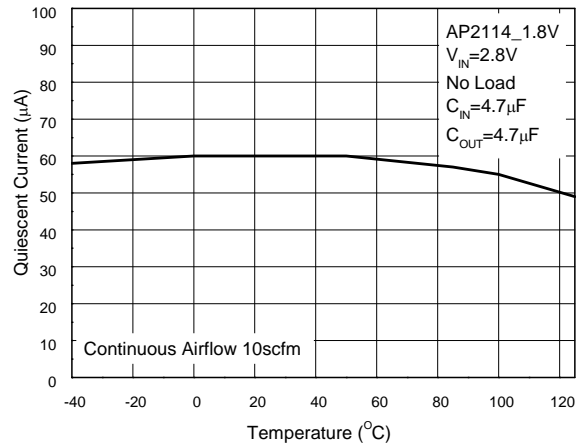

Figure 9. Quiescent Current vs. Temperature

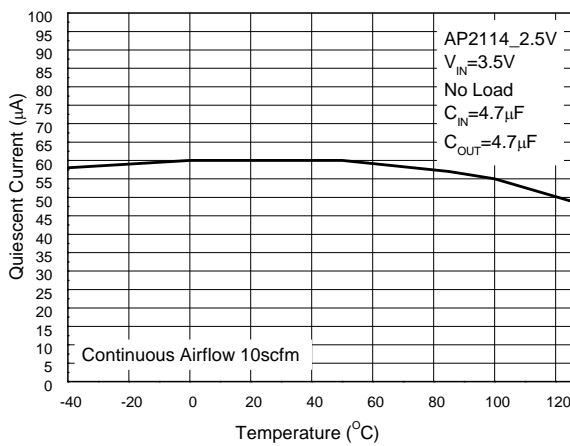

Figure 10. Quiescent Current vs. Temperature

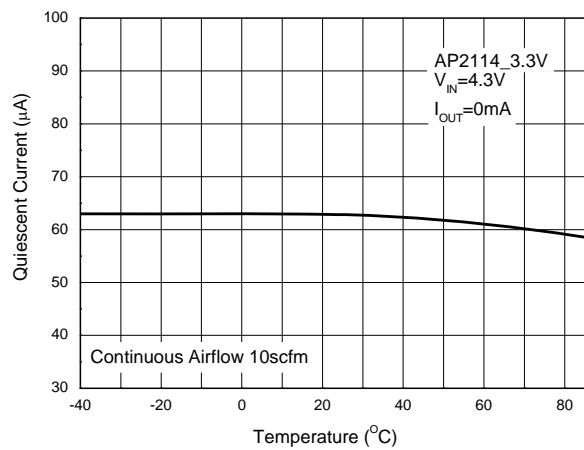

Figure 11. Quiescent Current vs. Temperature

**1A LOW NOISE CMOS LDO REGULATOR WITH ENABLE AP2114**

**Typical Performance Characteristics (Continued)**

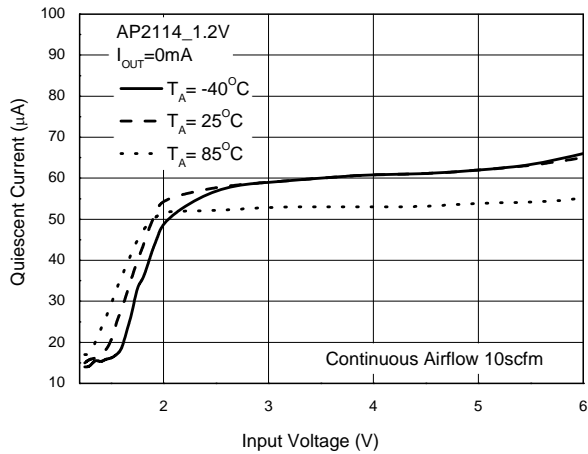

Figure 12. Quiescent Current vs. Input Voltage

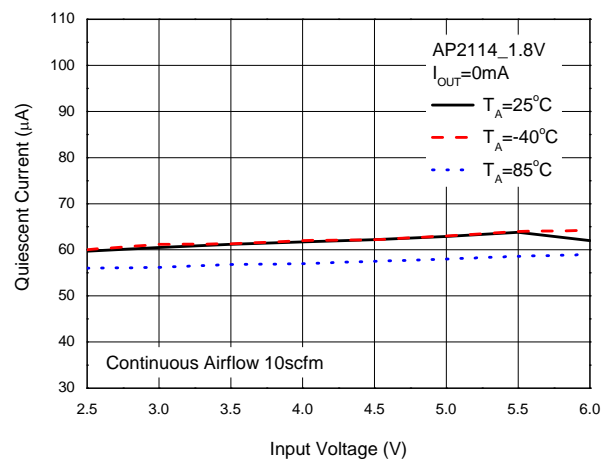

Figure 13. Quiescent Current vs. Input Voltage

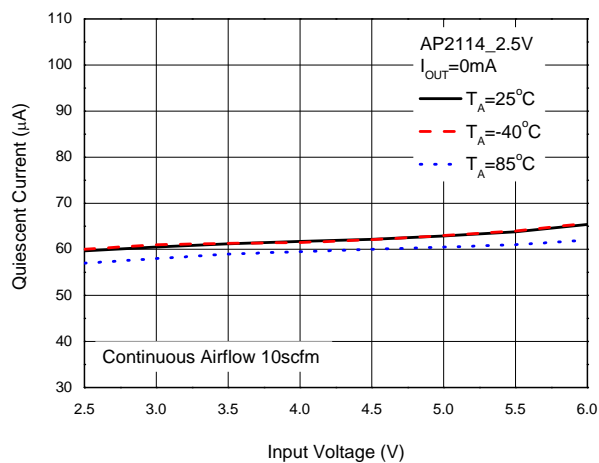

Figure 14. Quiescent Current vs. Input Voltage

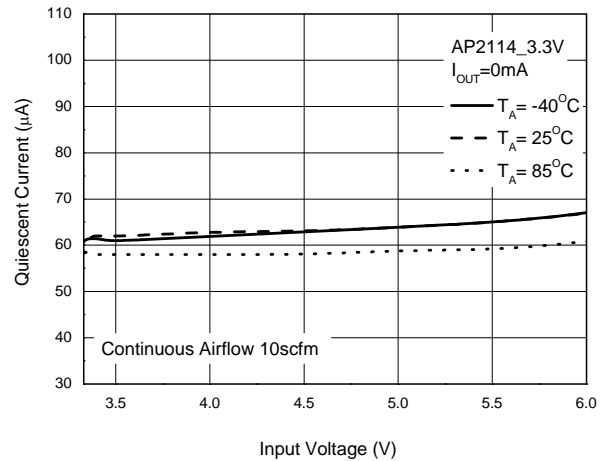

Figure 15. Quiescent Current vs. Input Voltage

**1A LOW NOISE CMOS LDO REGULATOR WITH ENABLE AP2114**

**Typical Performance Characteristics (Continued)**

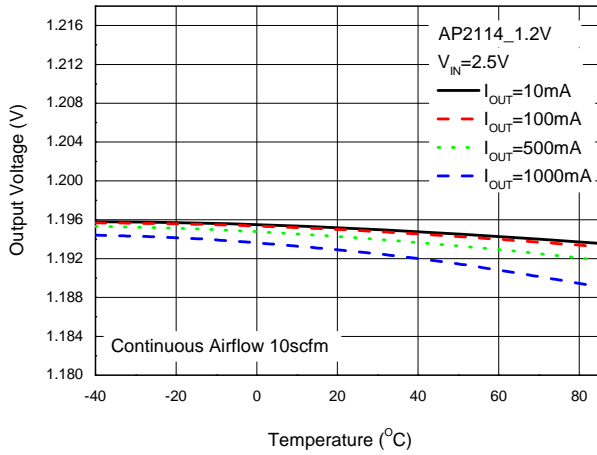

Figure 16. Output Voltage vs. Temperature

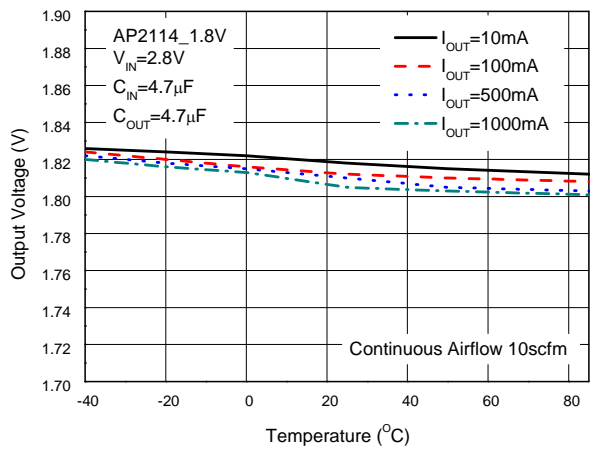

Figure 17. Output Voltage vs. Temperature

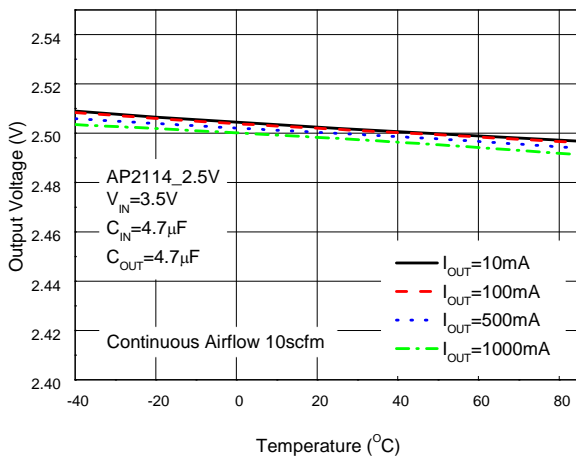

Figure 18. Output Voltage vs. Temperature

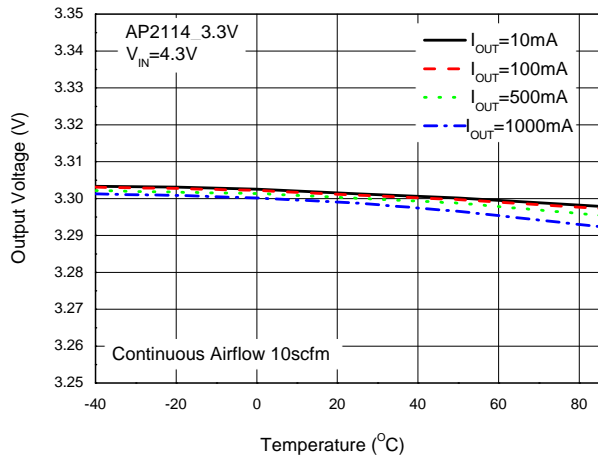

Figure 19. Output Voltage vs. Temperature

**1A LOW NOISE CMOS LDO REGULATOR WITH ENABLE AP2114**

**Typical Performance Characteristics (Continued)**

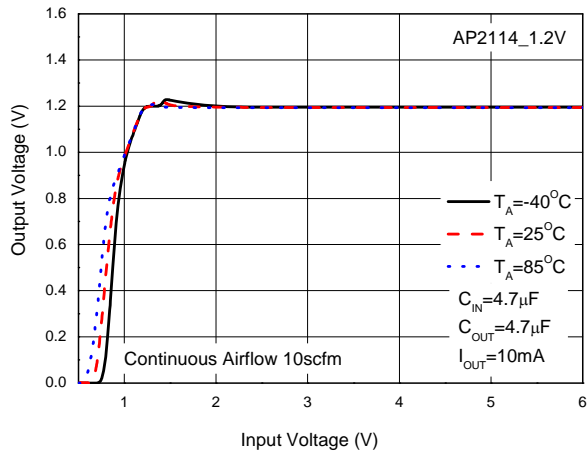

Figure 20. Output Voltage vs. Input Voltage

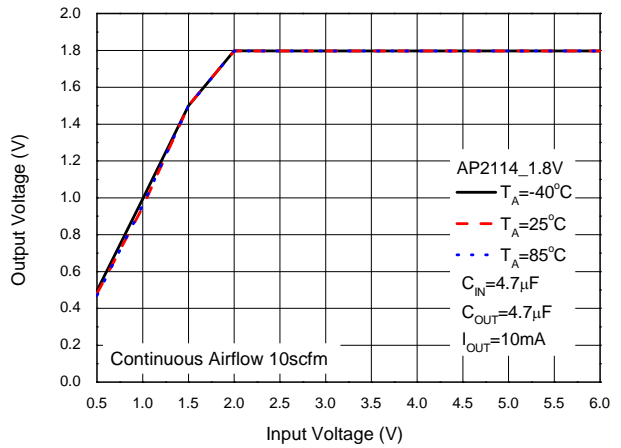

Figure 21. Output Voltage vs. Input Voltage

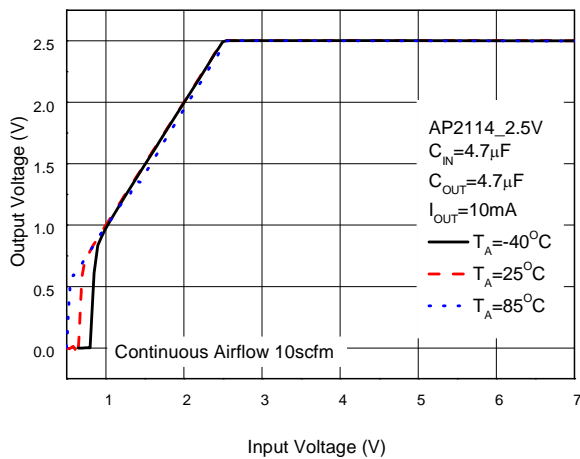

Figure 22. Output Voltage vs. Input Voltage

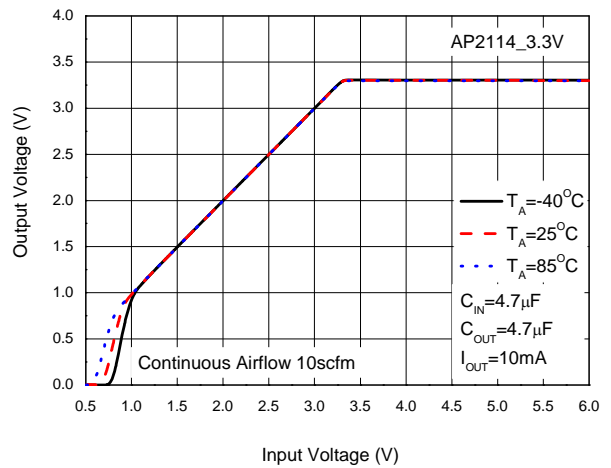

Figure 23. Output Voltage vs. Input Voltage

**1A LOW NOISE CMOS LDO REGULATOR WITH ENABLE AP2114**

**Typical Performance Characteristics (Continued)**

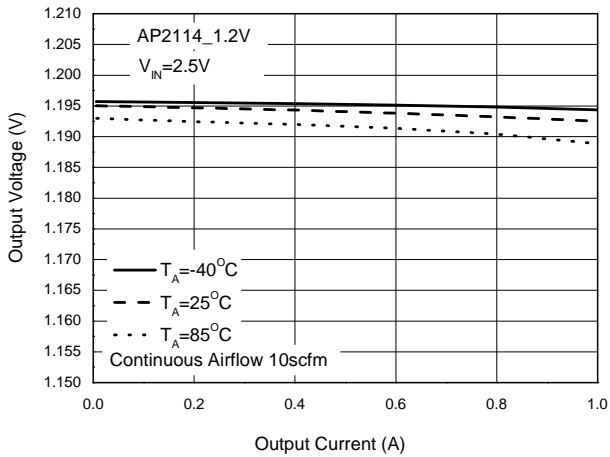

Figure 24. Output Voltage vs. Output Current

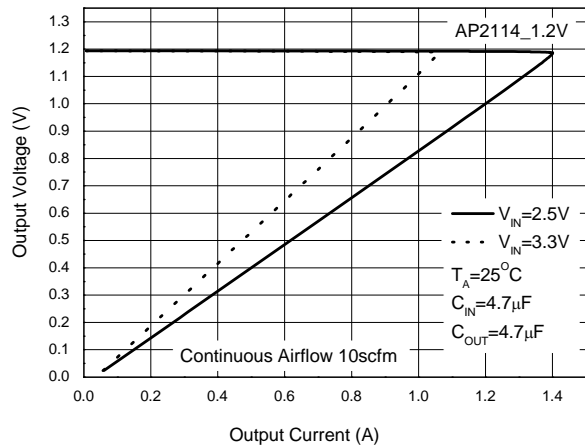

Figure 25. Output Voltage vs. Output Current

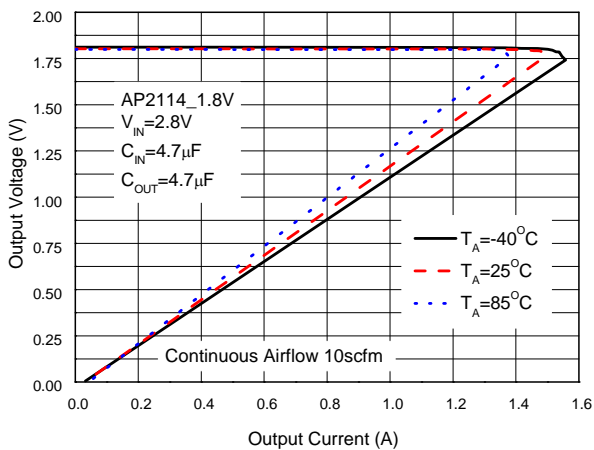

Figure 26. Output Voltage vs. Output Current

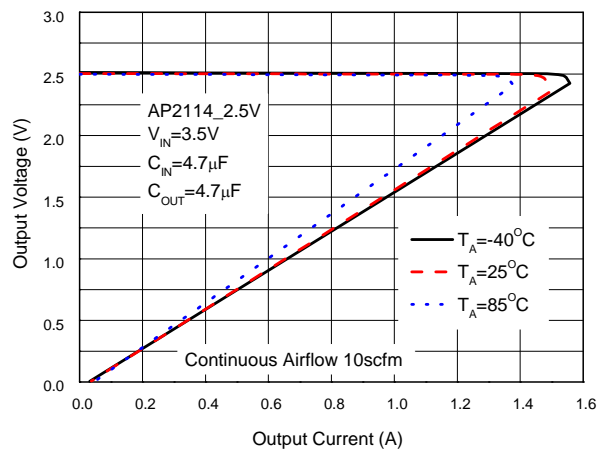

Figure 27. Output Voltage vs. Output Current

**1A LOW NOISE CMOS LDO REGULATOR WITH ENABLE AP2114**

**Typical Performance Characteristics (Continued)**

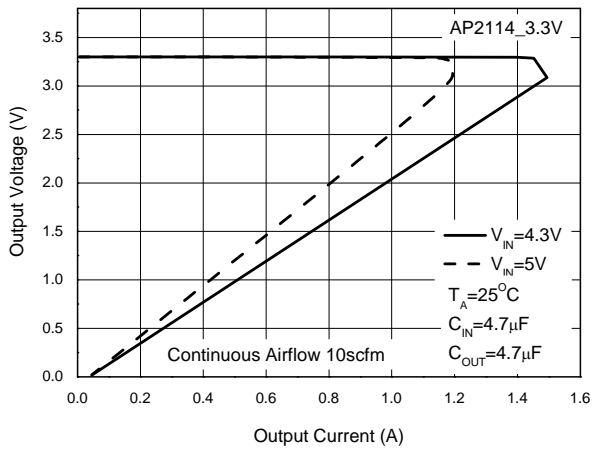

Figure 28. Output Voltage vs. Output Current

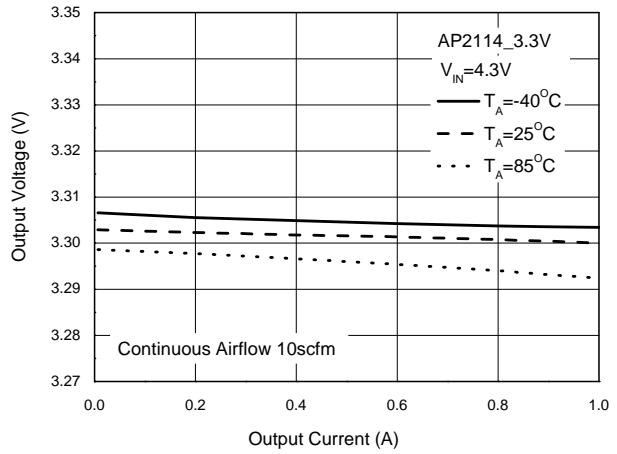

Figure 29. Output Voltage vs. Output Current

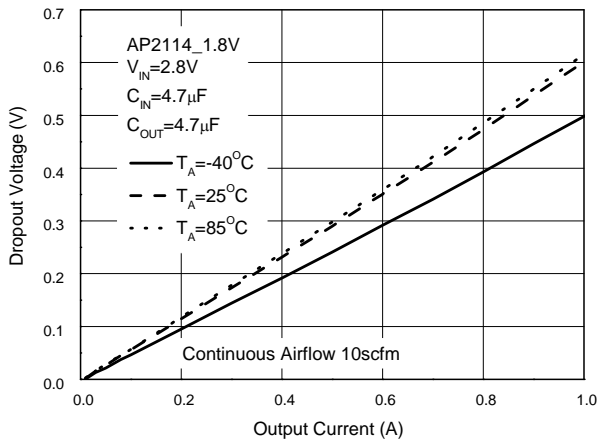

Figure 30. Dropout Voltage vs. Output Current

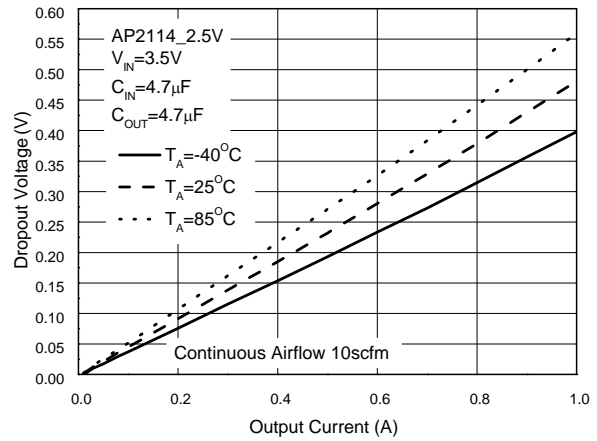

Figure 31. Dropout Voltage vs. Output Current

**1A LOW NOISE CMOS LDO REGULATOR WITH ENABLE AP2114**

**Typical Performance Characteristics (Continued)**

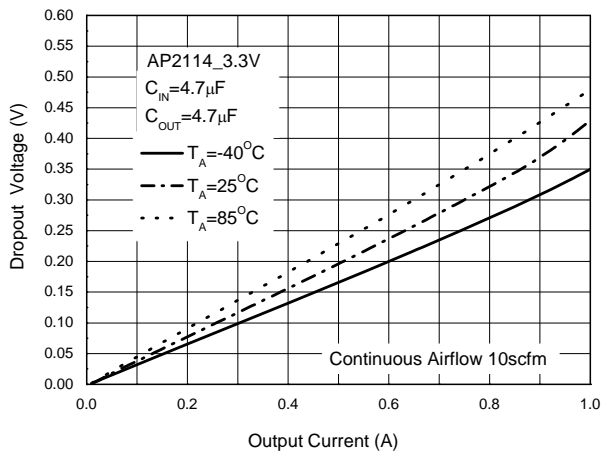

Figure 32. Dropout Voltage vs. Output Current

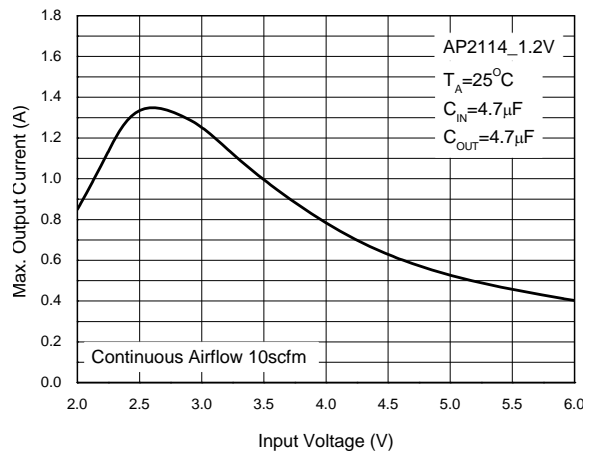

Figure 33. Max. Output Current vs. Input Voltage

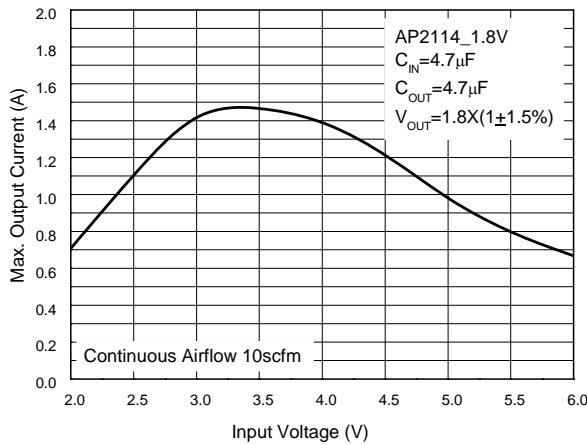

Figure 34. Max. Output Current vs. Input Voltage

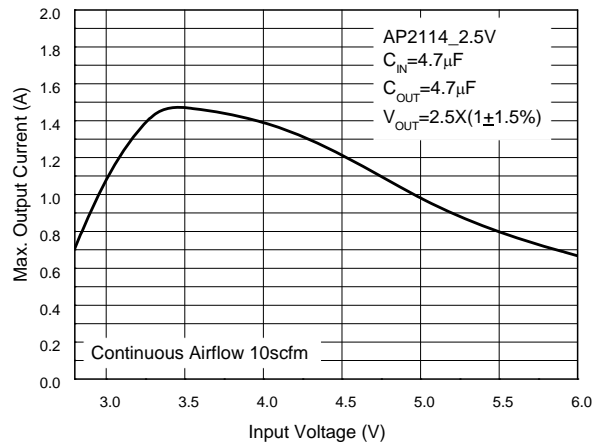

Figure 35. Max. Output Current vs. Input Voltage

**1A LOW NOISE CMOS LDO REGULATOR WITH ENABLE AP2114**

**Typical Performance Characteristics (Continued)**

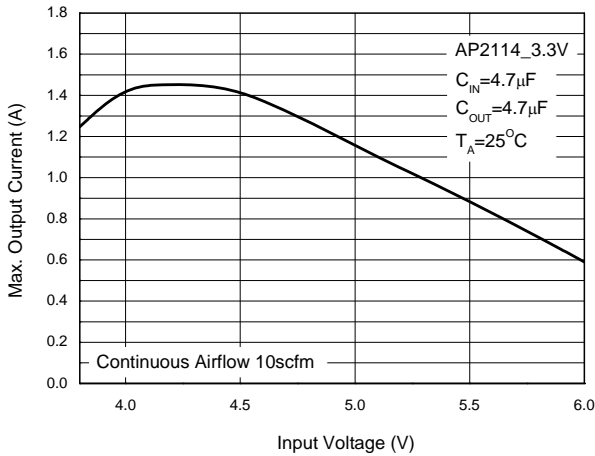

Figure 36. Max. Output Current vs. Input Voltage

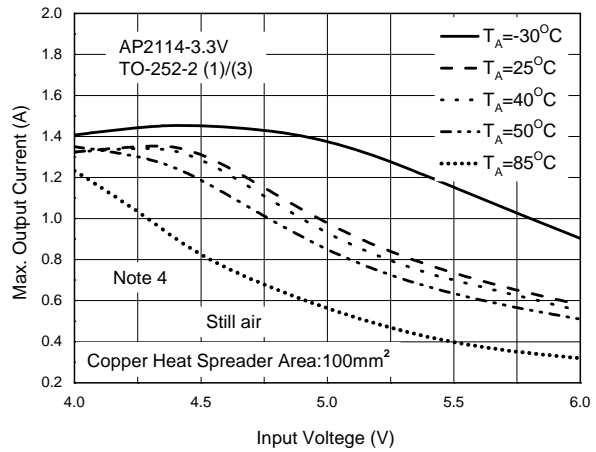

Figure 37. Max. Output Current vs. Input Voltage

Note 4: Considering power dissipation and thermal behavior, we suggest provide enough design margins in application design which are no less than 30% at least.

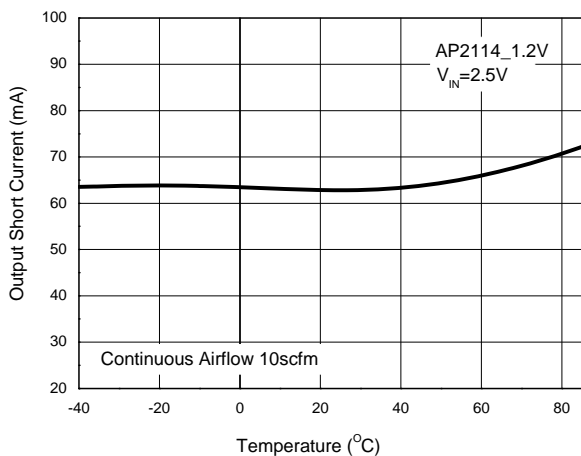

Figure 38. Output Short Current vs. Temperature

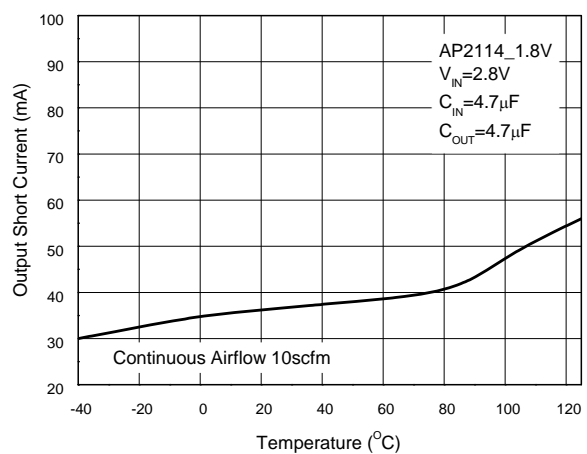

Figure 39. Output Short Current vs. Temperature



# 1A LOW NOISE CMOS LDO REGULATOR WITH ENABLE AP2114

## Typical Performance Characteristics (Continued)

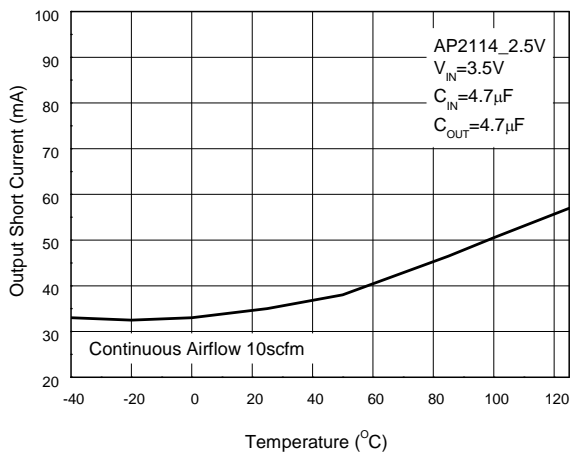

Figure 40. Output Short Current vs. Temperature

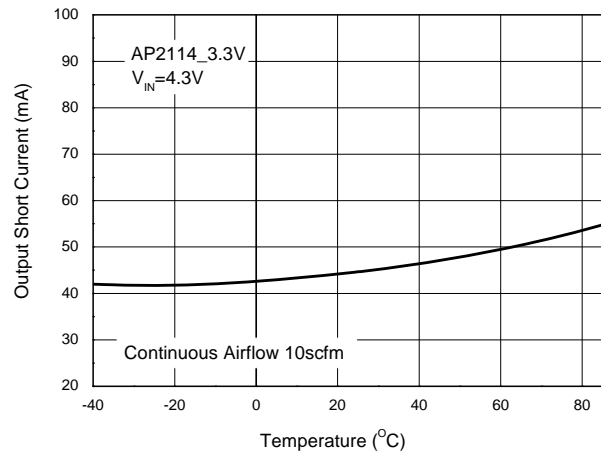

Figure 41. Output Short Current vs. Temperature

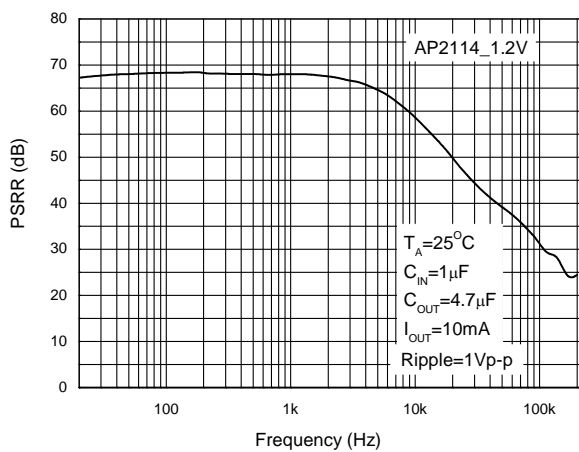

Figure 42. PSRR vs. Frequency

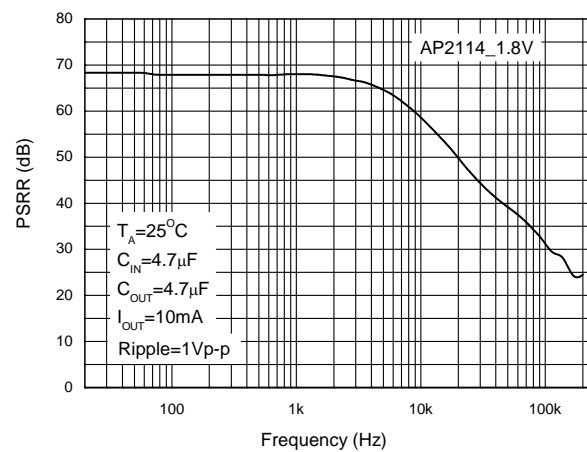

Figure 43. PSRR vs. Frequency

**1A LOW NOISE CMOS LDO REGULATOR WITH ENABLE AP2114**

**Typical Performance Characteristics (Continued)**

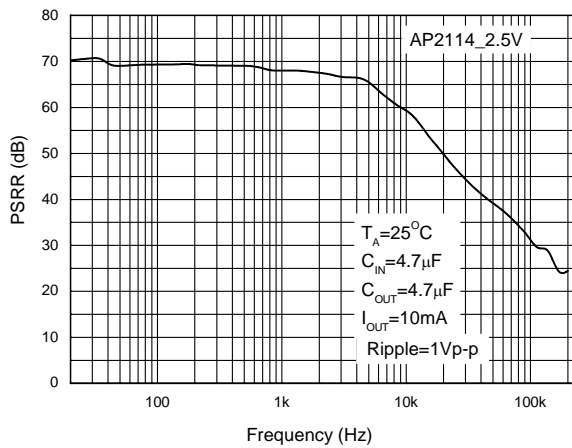

Figure 44. PSRR vs. Frequency

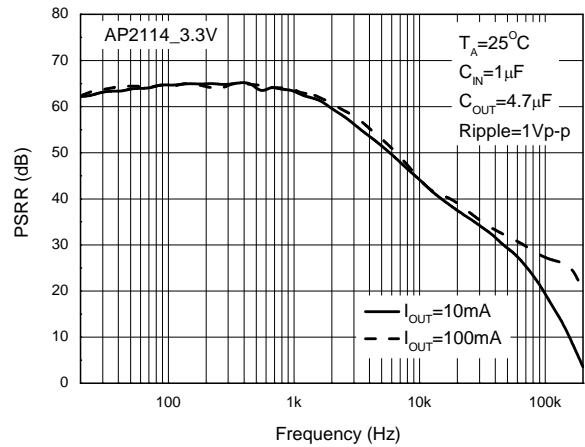

Figure 45. PSRR vs. Frequency

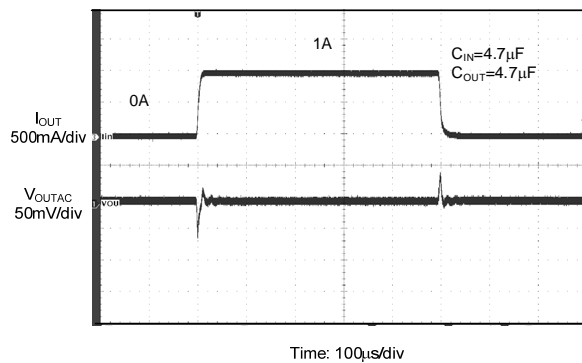

Figure 46. Load Transient

# 1A LOW NOISE CMOS LDO REGULATOR WITH ENABLE AP2114

## Typical Application

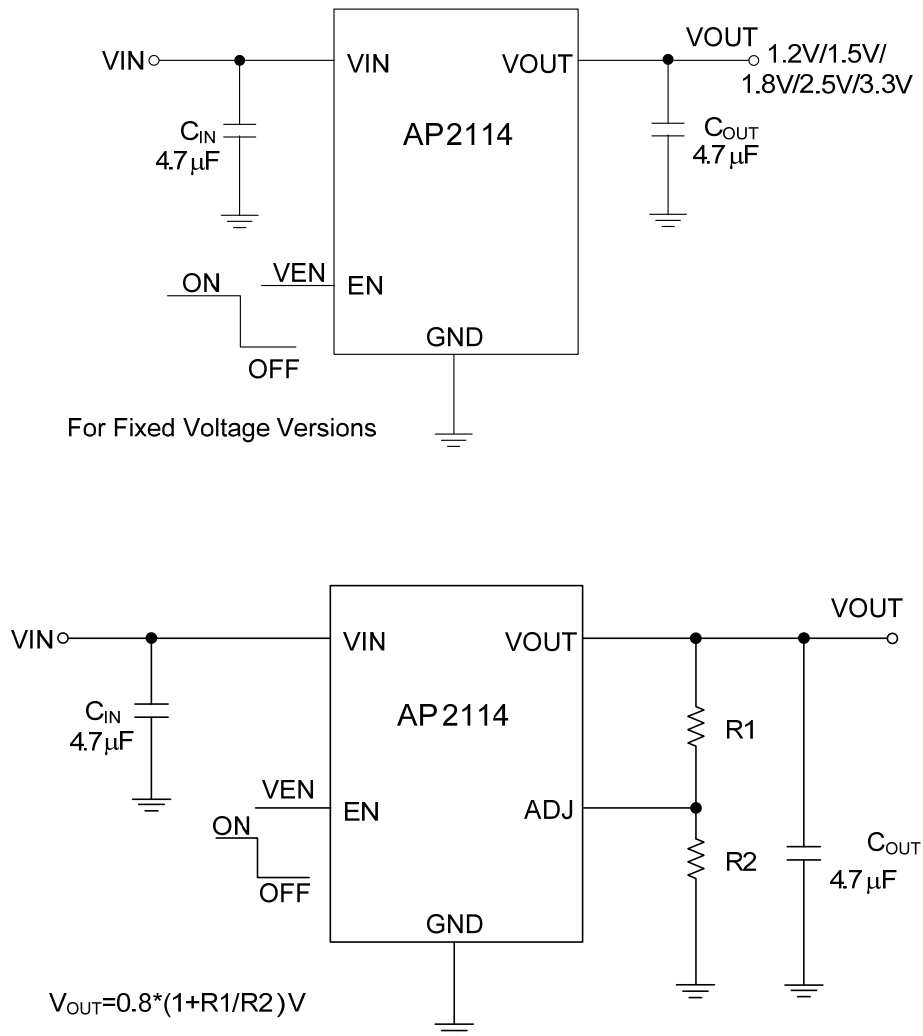

Figure 47. Typical Application of AP2114

**1A LOW NOISE CMOS LDO REGULATOR WITH ENABLE AP2114**

**Mechanical Dimensions**

**SOT-223**

**Unit: mm(inch)**

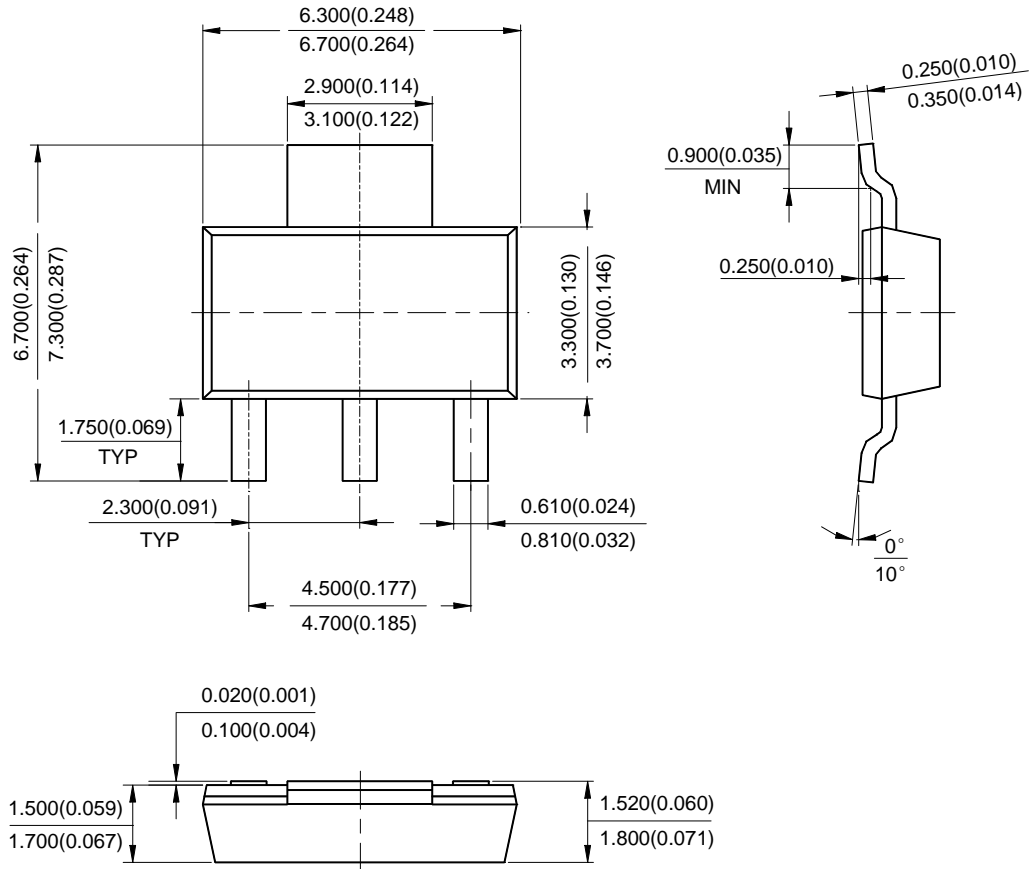

**1A LOW NOISE CMOS LDO REGULATOR WITH ENABLE AP2114**

**Mechanical Dimensions (Continued)**

**TO-252-2 (1)**

**Unit: mm(inch)**

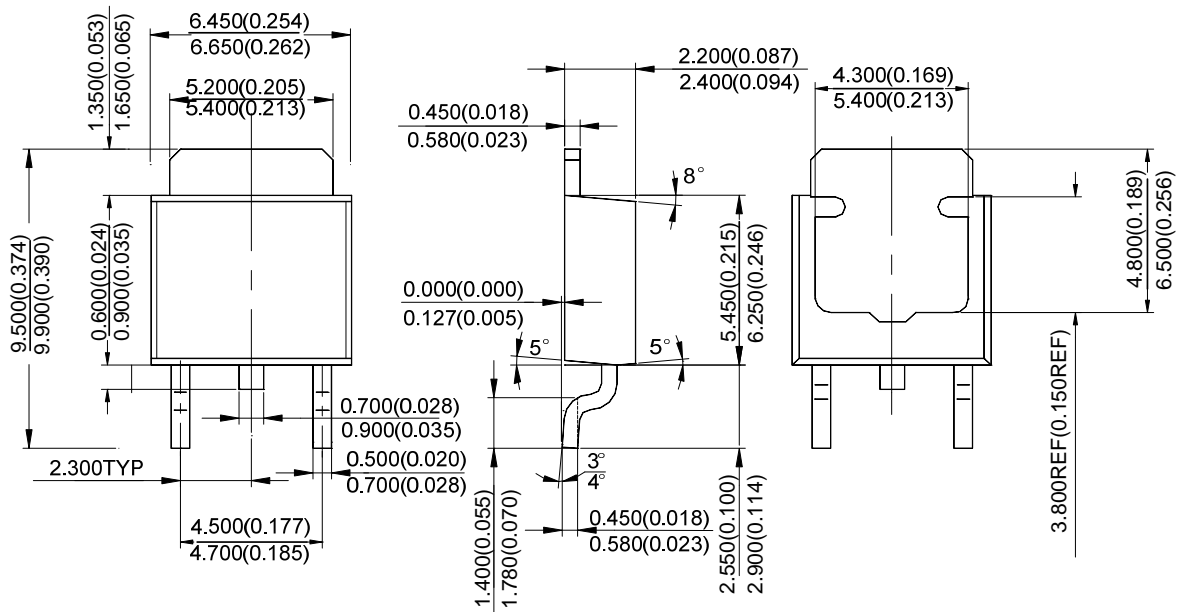

**1A LOW NOISE CMOS LDO REGULATOR WITH ENABLE AP2114**

**Mechanical Dimensions (Continued)**

**TO-252-2 (3)**

**Unit: mm(inch)**

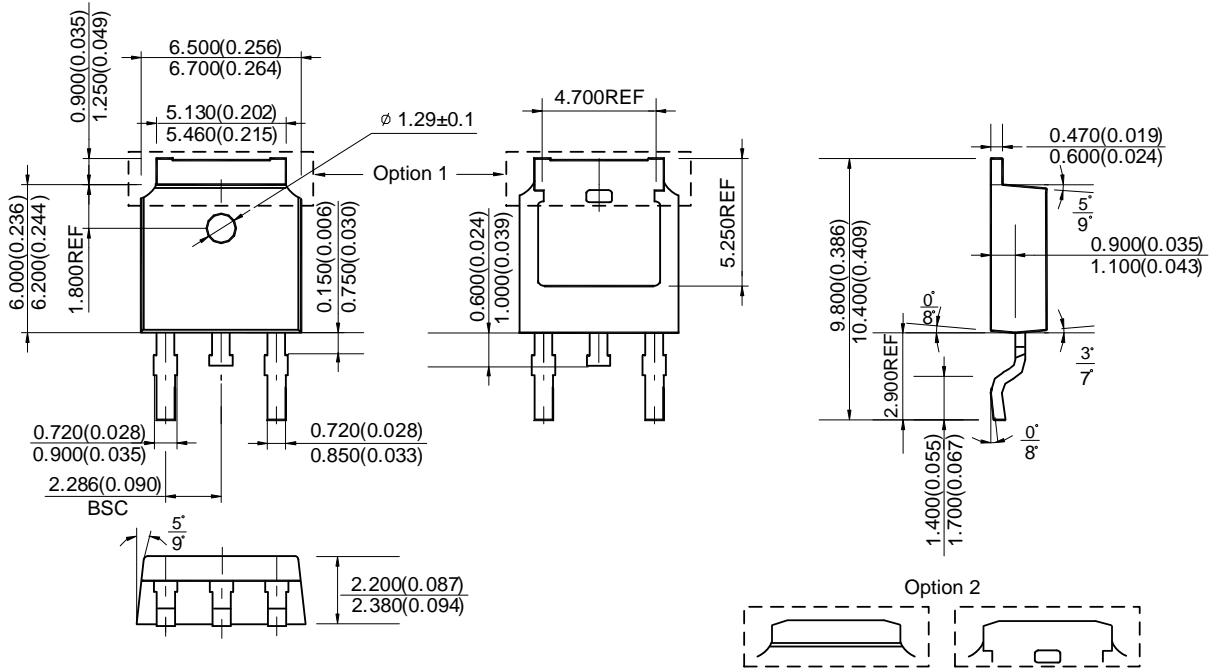

**1A LOW NOISE CMOS LDO REGULATOR WITH ENABLE AP2114**

**Mechanical Dimensions (Continued)**

**TO-252-2 (4)**

**Unit: mm(inch)**

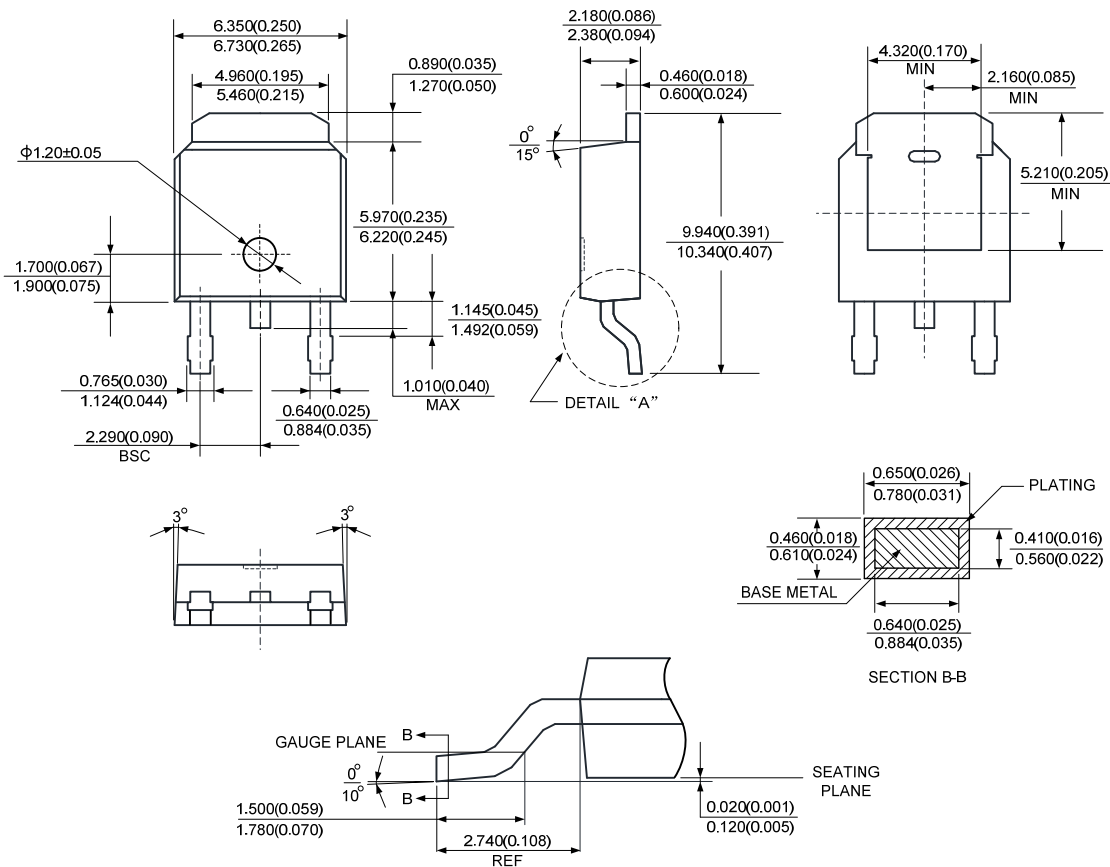

**1A LOW NOISE CMOS LDO REGULATOR WITH ENABLE AP2114**

**Mechanical Dimensions (Continued)**

**TO-263-3**

**Unit: mm(inch)**

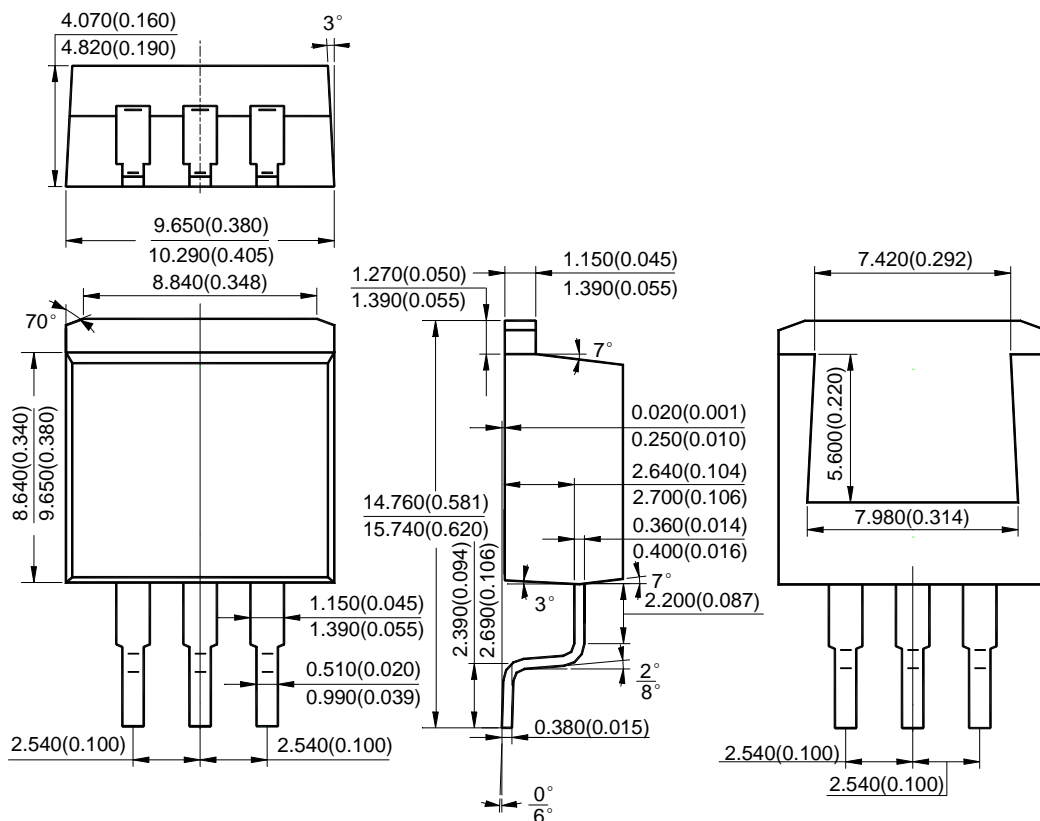

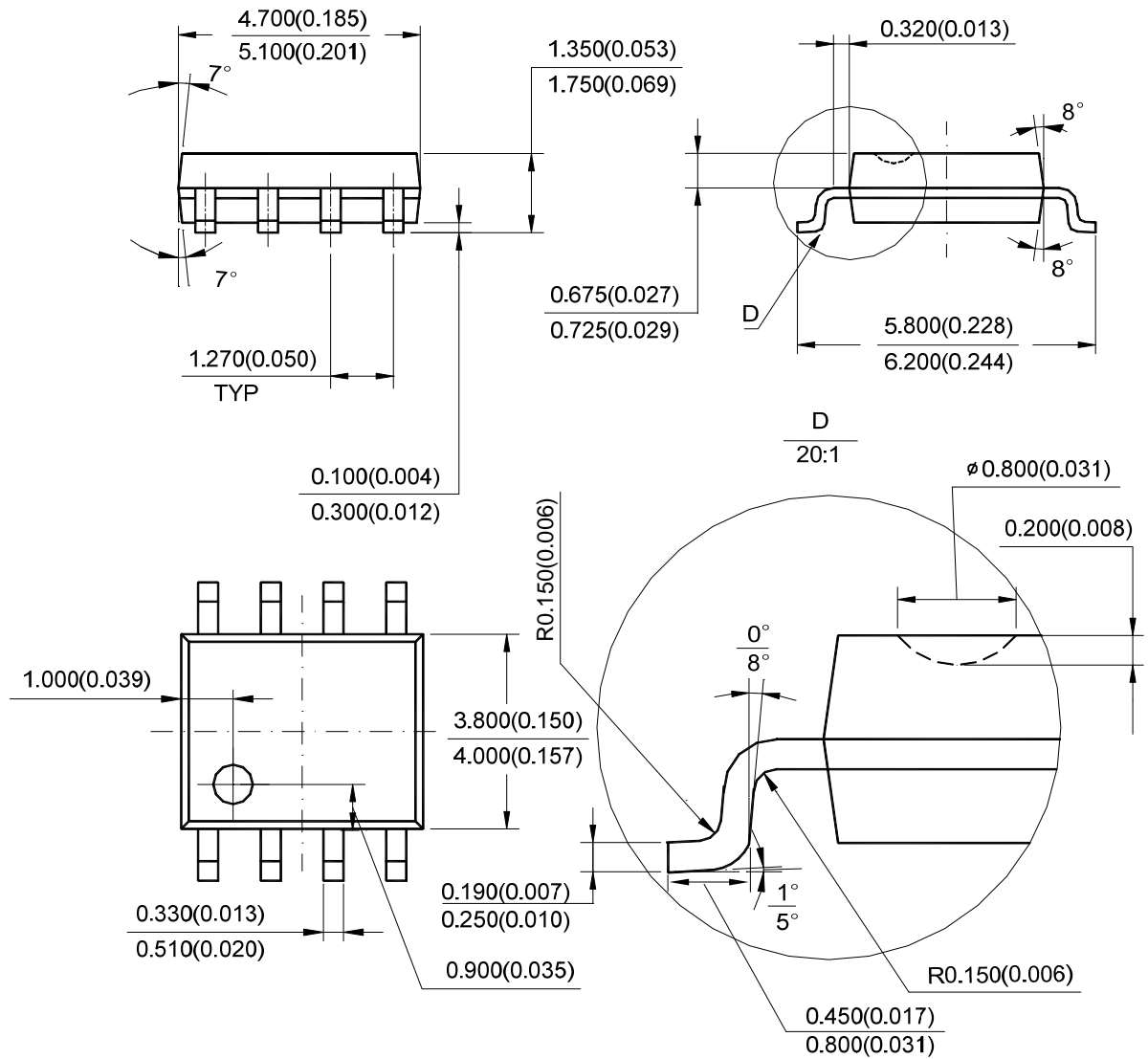
**1A LOW NOISE CMOS LDO REGULATOR WITH ENABLE AP2114****Mechanical Dimensions (Continued)****SOIC-8****Unit: mm(inch)**

Note: Eject hole, oriented hole and mold mark is optional.

**1A LOW NOISE CMOS LDO REGULATOR WITH ENABLE AP2114**

**Mechanical Dimensions (Continued)**

**PSOP-8**

**Unit: mm(inch)**

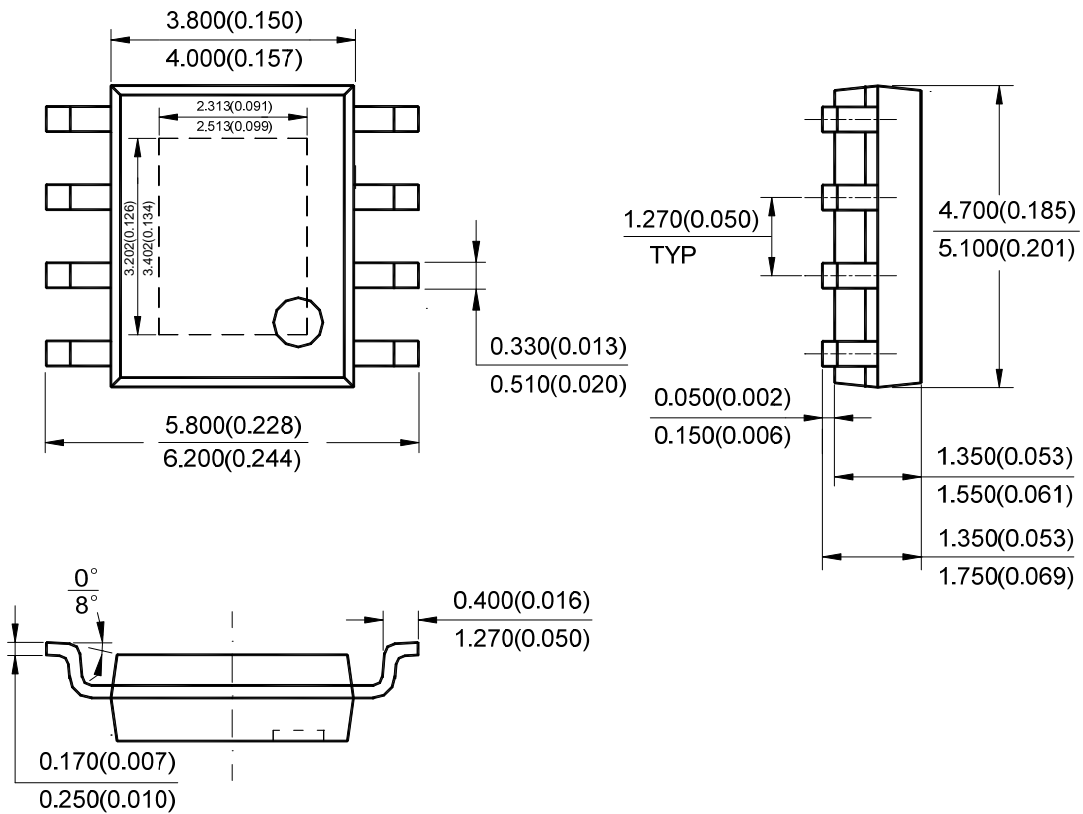

Note: Eject hole, oriented hole and mold mark is optional.



## **BCD Semiconductor Manufacturing Limited**

<http://www.bcdsemi.com>

### **IMPORTANT NOTICE**

BCD Semiconductor Manufacturing Limited reserves the right to make changes without further notice to any products or specifications herein. BCD Semiconductor Manufacturing Limited does not assume any responsibility for use of any its products for any particular purpose, nor does BCD Semiconductor Manufacturing Limited assume any liability arising out of the application or use of any its products or circuits. BCD Semiconductor Manufacturing Limited does not convey any license under its patent rights or other rights nor the rights of others.

---

#### **MAIN SITE**

##### **- Headquarters**

##### **BCD Semiconductor Manufacturing Limited**

No. 1600, Zi Xing Road, Shanghai Zizhu Science-based Industrial Park, 200241, China  
Tel: +86-21-24162266, Fax: +86-21-24162277

##### **- Wafer Fab**

##### **Shanghai SIM-BCD Semiconductor Manufacturing Co., Ltd.**

800 Yi Shan Road, Shanghai 200233, China  
Tel: +86-21-6485 1491, Fax: +86-21-5450 0008

#### **REGIONAL SALES OFFICE**

##### **Shenzhen Office**

##### **Shanghai SIM-BCD Semiconductor Manufacturing Co., Ltd., Shenzhen Office**

Unit A Room 1203, Skyworth Bldg., Gaoxin Ave. 1.S., Nanshan District, Shenzhen, China  
Tel: +86-755-8826 7951  
Fax: +86-755-8826 7865

##### **Taiwan Office**

##### **BCD Semiconductor (Taiwan) Company Limited**

4F, 298-1, Rui Guang Road, Nei-Hu District, Taipei, Taiwan  
Tel: +886-2-2656 2808  
Fax: +886-2-2656 2806

##### **USA Office**

##### **BCD Semiconductor Corp.**

30920 Huntwood Ave. Hayward, CA 94544, USA  
Tel : +1-510-324-2988  
Fax: +1-510-324-2788

## Looking for pricing, stock, or lifecycle information?

Click below to explore more details on WIN SOURCE:

- ⊖ [View AP2114H-1.2TRG1 on WIN SOURCE](#)
- ⊖ [Diodes Incorporated Information](#)

## Optimize Your Supply Chain with WIN SOURCE Solutions

- ✓ Global Sourcing Solution
- ✓ Obsolete Management
- ✓ Cost Control Management
- ✓ Shortage Management
- ✓ Alternative Solution
- ✓ Excess Inventory Management