



**THE DATASHEET OF
AP2401B34DNTR-G1**





PART IS OBSOLETE
PLEASE USE AP7312

Data Sheet

200mA DUAL CHANNEL CMOS LDO REGULATOR

AP2401

General Description

The AP2401 series are dual positive voltage regulator ICs fabricated by CMOS process. Each of these ICs consists of a voltage reference, two error amplifiers, two resistor networks for setting output voltages. Each channel has a current limit circuit for current protection.

The AP2401 series feature high ripple rejection, low dropout voltage, low noise, high output voltage accuracy, and low current consumption which make them ideal for use in various battery-powered devices. The chip enable function allows the output of each channel to be turned on/off independently, greatly reducing the power consumption.

The AP2401 series have 1.2V/1.8V, 1.8V/2.5V, 1.8V/2.8V, 1.8V/3.3V, 2.8V/1.8V and 2.8V/3.3V versions.

The AP2401 are available in standard SOT-23-6 and DFN-1.8x2-6 packages.

Features

- Maximum Output Current/Channel: More Than 200mA (300mA Limit)
- High Output Voltage Accuracy: $\pm 2\%$
- Low Quiescent Current/Channel: 25 μ A Typical
- Low Standby Current: 0.1 μ A Typical
- High PSRR: 70dB Typical ($f=1$ kHz)
- Extremely Low Noise: 30 μ Vrms (10Hz to 100kHz)
- Operating Temperature: -40 to 85 $^{\circ}$ C
- Compatible with Low ESR Ceramic Capacitor

Applications

- Mobile Phones, Cordless Phones
- Wireless Communication Equipment
- Portable Games
- Cameras, Video Recorders
- Sub-board Power Supplies for Telecom Equipment
- Battery Powered Equipment

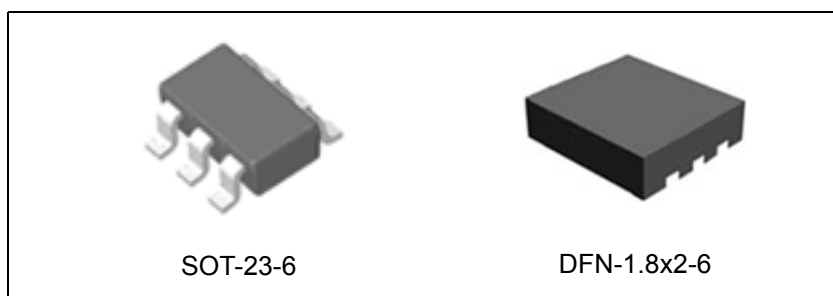

Figure 1. Package Types of AP2401



PART IS OBSOLETE PLEASE USE AP7312

Data Sheet

200mA DUAL CHANNEL CMOS LDO REGULATOR

AP2401

Pin Configuration

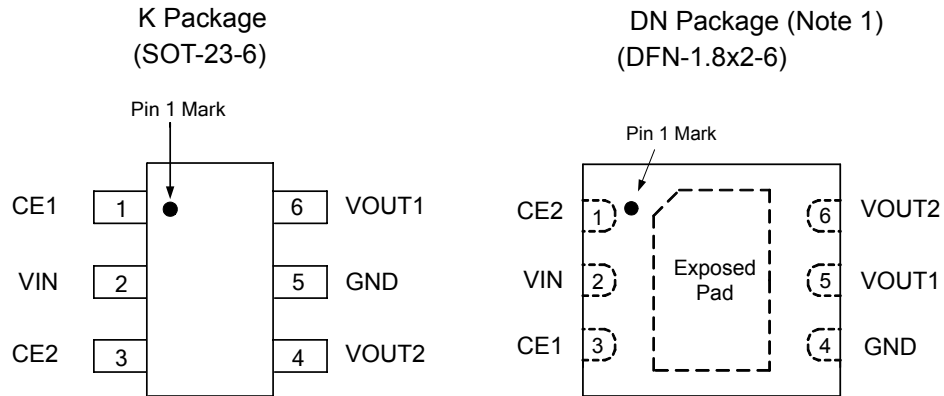

Note 1: The exposed pad should be connected to GND for better dissipation or left open.

Figure 2. Pin Configuration of AP2401 (Top View)

Pin Description

Pin Number		Pin Name	Function
SOT-23-6	DFN-1.8x2-6		
1	3	CE1	On/Off Control 1, Logic High=enable; Logic Low=Shutdown
2	2	VIN	Input Voltage
3	1	CE2	On/Off Control 2, Logic High=enable; Logic Low=Shutdown
4	6	VOUT2	Output Voltage 2
5	4	GND	Ground
6	5	VOUT1	Output Voltage 1



PART IS OBSOLETE
PLEASE USE AP7312

Data Sheet

200mA DUAL CHANNEL CMOS LDO REGULATOR

AP2401

Functional Block Diagram

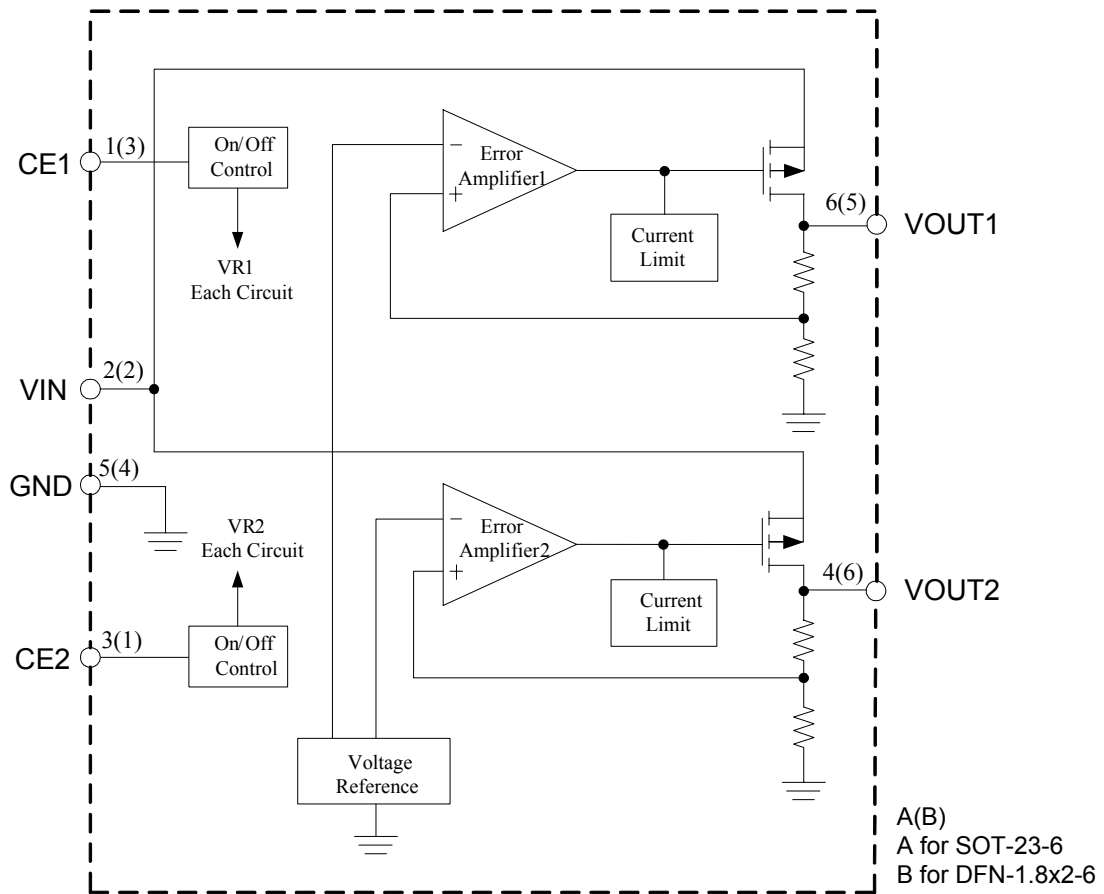

Figure 3. Functional Block Diagram of AP2401



**PART IS OBSOLETE
PLEASE USE AP7312**

Data Sheet

200mA DUAL CHANNEL CMOS LDO REGULATOR AP2401

Ordering Information

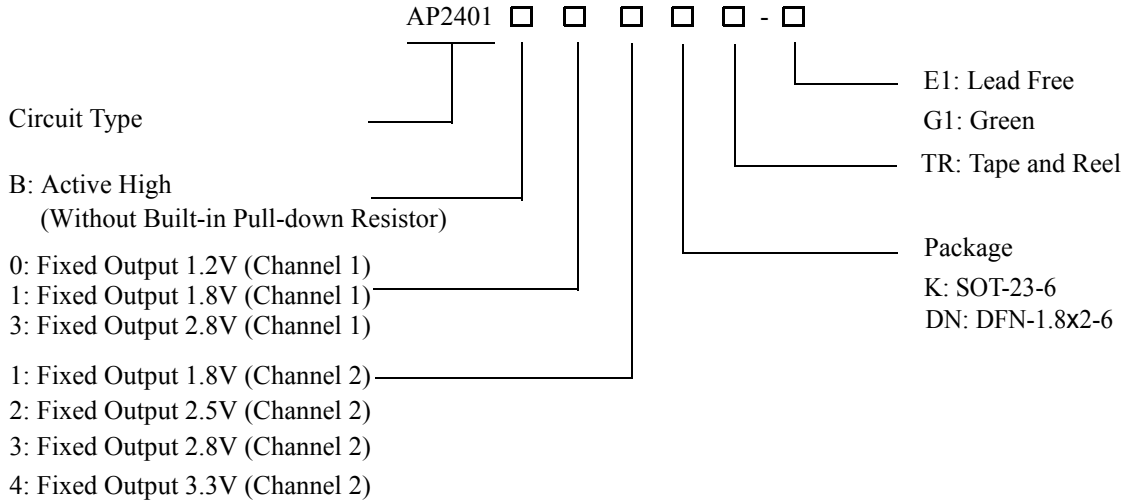

Package	Temperature Range	Condition	Output Voltages	Part Number		Marking ID		Packing Type
				Lead Free	Green	Lead Free	Green	
SOT-23-6	-40 to 85°C	Active High Without Built-in Pull-down Resistor	1.2V/1.8V	AP2401B01KTR-E1	AP2401B01KTR-G1	E8P	G7Q	Tape & Reel
		Active High Without Built-in Pull-down Resistor	1.8V/2.5V	AP2401B12KTR-E1	AP2401B12KTR-G1	E9P	G9P	Tape & Reel
		Active High Without Built-in Pull-down Resistor	1.8V/2.8V	AP2401B13KTR-E1	AP2401B13KTR-G1	E9Q	G9Q	Tape & Reel
		Active High Without Built-in Pull-down Resistor	1.8V/3.3V	AP2401B14KTR-E1	AP2401B14KTR-G1	E9R	G9R	Tape & Reel
		Active High Without Built-in Pull-down Resistor	2.8V/1.8V	AP2401B31KTR-E1	AP2401B31KTR-G1	E8R	G8R	Tape & Reel
		Active High Without Built-in Pull-down Resistor	2.8V/3.3V	AP2401B34KTR-E1	AP2401B34KTR-G1	E8Q	G8Q	Tape & Reel
DFN-1.8x2-6	-40 to 85°C	Active High Without Built-in Pull-down Resistor	1.2V/1.8V	AP2401B01DNTR-E1	AP2401B01DNTR-G1	3A	VA	Tape & Reel
		Active High Without Built-in Pull-down Resistor	1.8V/2.8V	AP2401B13DNTR-E1	AP2401B13DNTR-G1	3B	VB	Tape & Reel
		Active High Without Built-in Pull-down Resistor	2.8V/3.3V	AP2401B34DNTR-E1	AP2401B34DNTR-G1	3C	VC	Tape & Reel

BCD Semiconductor's Pb-free products, as designated with "E1" suffix in the part number, are RoHS compliant. Products with "G1" suffix are available in green packages.



**PART IS OBSOLETE
PLEASE USE AP7312**

Data Sheet

200mA DUAL CHANNEL CMOS LDO REGULATOR

AP2401

Absolute Maximum Ratings (Note 2)

Parameter	Symbol	Value	Unit
Input Voltage	V_{IN}	6.5	V
Enable Input Voltage	V_{CE}	6.5	V
Output Current ($T_A=25^{\circ}C$)	$I_{OUT1}+I_{OUT2}$	700	mA
Power Dissipation ($T_A=25^{\circ}C$)	P_D	250	mW
Junction Temperature	T_J	150	$^{\circ}C$
Storage Temperature Range	T_{STG}	-65 to 150	$^{\circ}C$
Lead Temperature (Soldering, 10sec)	T_{LEAD}	260	$^{\circ}C$
ESD (Human Body Model)	ESD	3000	V

Note 2: Stresses greater than those listed under "Absolute Maximum Ratings" may cause permanent damage to the device. These are stress ratings only, and functional operation of the device at these or any other conditions beyond those indicated under "Recommended Operating Conditions" is not implied. Exposure to "Absolute Maximum Ratings" for extended periods may affect device reliability.

Recommended Operating Conditions

Parameter	Symbol	Min	Max	Unit
Input Voltage	V_{IN}		6	V
Operating Ambient Temperature Range	T_A	-40	85	$^{\circ}C$



**PART IS OBSOLETE
PLEASE USE AP7312**

Data Sheet

200mA DUAL CHANNEL CMOS LDO REGULATOR **AP2401**

Electrical Characteristics

(Channel 1/Channel 2: $V_{IN}=V_{OUT}+1V$, $T_J=25^{\circ}C$, $C_{IN}=1\mu F$, $C_{OUT}=1\mu F$, unless otherwise specified.)

Parameter	Symbol	Conditions	Min	Typ	Max	Unit	
Output Voltage Accuracy	$\Delta V_{OUT}/V_{OUT}$	Variation from specified V_{OUT} , $I_{OUT}=30mA$	-2		2	%	
Input Voltage	V_{IN}				6	V	
Maximum Output Current	I_{OUT}		200			mA	
Load Regulation	V_{RLOAD}	$1mA \leq I_{OUT} \leq 200mA$		40	60	mV	
Line Regulation	V_{RLINE}	$V_{OUT}+1V \leq V_{IN} \leq 6V$ $I_{OUT}=30mA$, $V_{CE}=V_{IN}$		0.01	0.2	%/V	
Dropout Voltage	V_{DROP}	$I_{OUT}=30mA$	$V_{OUT}=1.2V$		700	750	mV
			$V_{OUT}=1.8V$		60	70	
			$V_{OUT}=2.5V$		45	55	
			$V_{OUT}=2.8V$		45	55	
			$V_{OUT}=3.3V$		35	45	
		$I_{OUT}=100mA$	$V_{OUT}=1.2V$		800	900	
			$V_{OUT}=1.8V$		175	195	
			$V_{OUT}=2.5V$		135	160	
			$V_{OUT}=2.8V$		135	160	
		$I_{OUT}=200mA$	$V_{OUT}=3.3V$		125	150	
			$V_{OUT}=1.2V$		1000	1200	
			$V_{OUT}=1.8V$		365	550	
$V_{OUT}=2.5V$			275	500			
Quiescent Current	I_Q	$V_{CE}=V_{IN}=V_{OUT}+1V$, $I_{OUT}=0mA$		25	45	μA	
Standby Current	I_{STD}	V_{CE} in OFF mode		0.1	1	μA	
Power Supply Rejection Ratio	PSRR	Ripple 0.5Vp-p, $f=1kHz$ $V_{IN}=V_{OUT}+1V$, $I_{OUT}=30mA$		70		dB	
Output Voltage Temperature Coefficient	$(\Delta V_{OUT}/V_{OUT})/\Delta T$	$I_{OUT}=30mA$, $-40^{\circ}C \leq T_J \leq 85^{\circ}C$		± 100		ppm/ $^{\circ}C$	
Current Limit	I_{LIMIT}	$V_{CE}=V_{IN}$		300		mA	
Short Circuit Current	I_{SHORT}	$V_{CE}=V_{IN}$, $V_{OUT}=0$		30		mA	
RMS Output Noise	V_{NOISE}	$T_A=25^{\circ}C$ $10Hz \leq f \leq 100kHz$		30		μV_{rms}	
CE "High" Voltage		CE input voltage "High"	1.3		6	V	
CE "Low" Voltage		CE input voltage "Low"			0.25	V	
Thermal Resistance (Junction to Case)	θ_{JC}	SOT-23-6		61.3		$^{\circ}C/W$	
		DFN-1.8x2-6		20			



PART IS OBSOLETE
PLEASE USE AP7312

Data Sheet

200mA DUAL CHANNEL CMOS LDO REGULATOR

AP2401

Typical Performance Characteristics

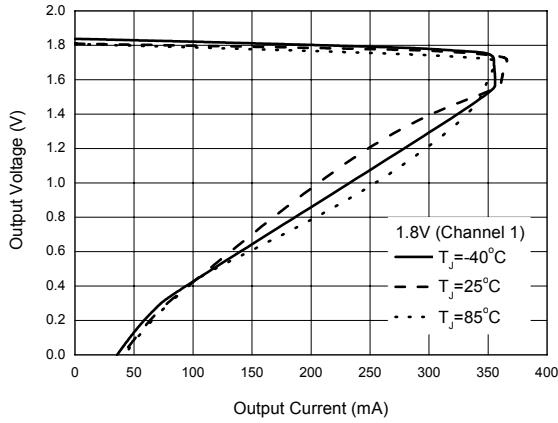

Figure 4. Output Voltage vs. Output Current

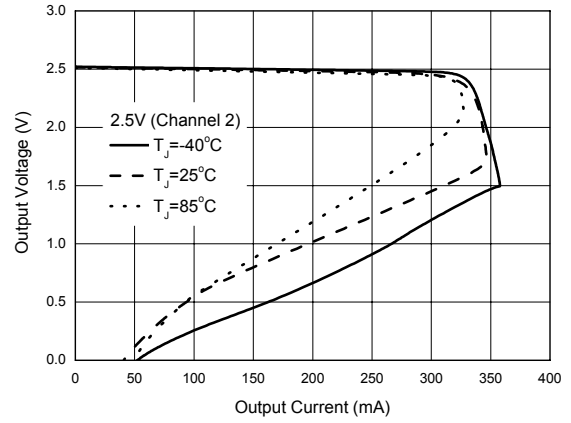

Figure 5. Output Voltage vs. Output Current

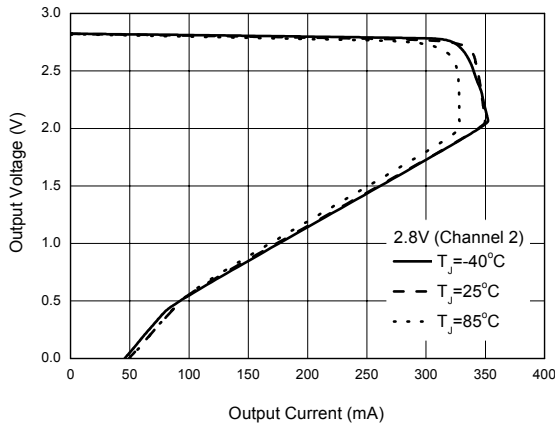

Figure 6. Output Voltage vs. Output Current

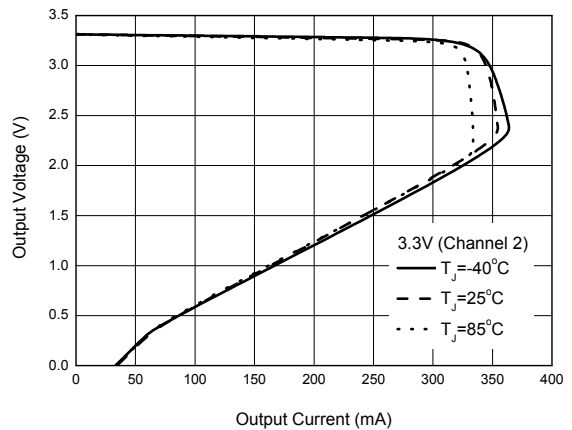

Figure 7. Output Voltage vs. Output Current



PART IS OBSOLETE
PLEASE USE AP7312

Data Sheet

200mA DUAL CHANNEL CMOS LDO REGULATOR

AP2401

Typical Performance Characteristics (Continued)

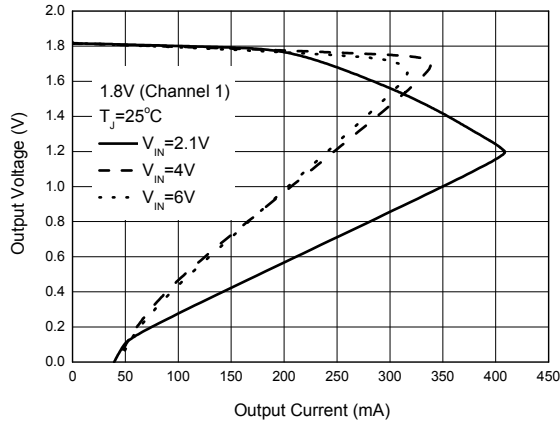

Figure 8. Output Voltage vs. Output Current

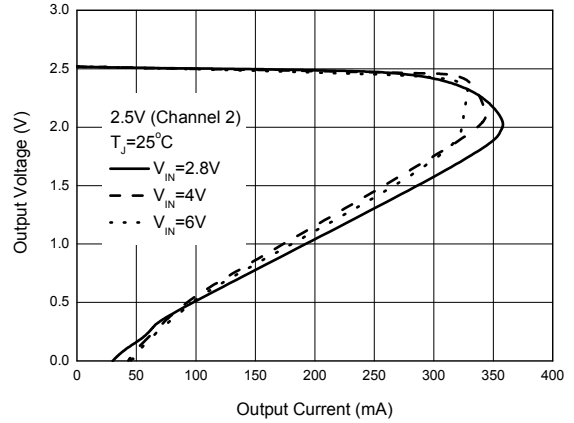

Figure 9. Output Voltage vs. Output Current

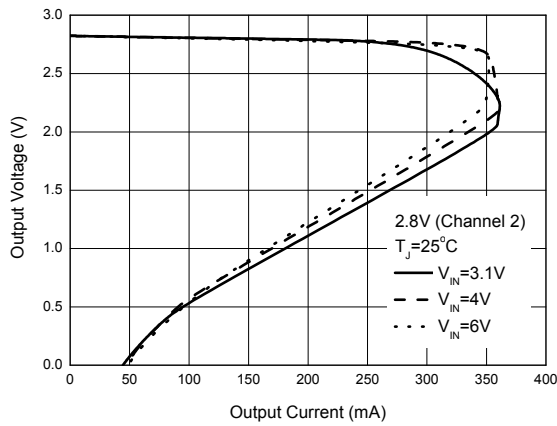

Figure 10. Output Voltage vs. Output Current

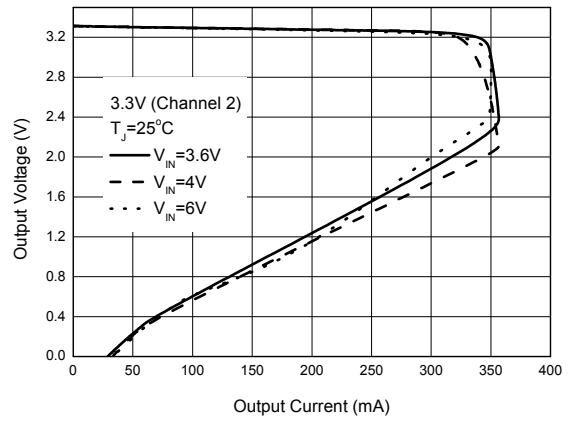

Figure 11. Output Voltage vs. Output Current



PART IS OBSOLETE
PLEASE USE AP7312

Data Sheet

200mA DUAL CHANNEL CMOS LDO REGULATOR

AP2401

Typical Performance Characteristics (Continued)

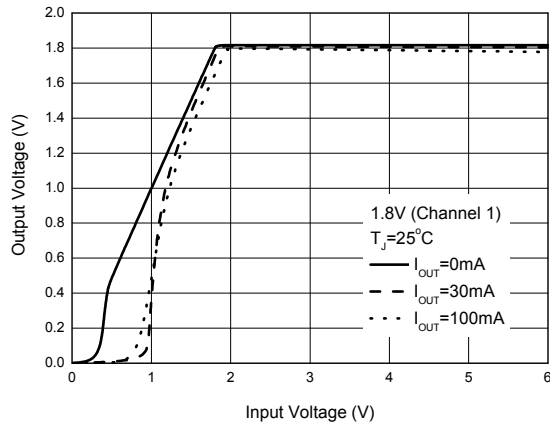

Figure 12. Output Voltage vs. Input Voltage

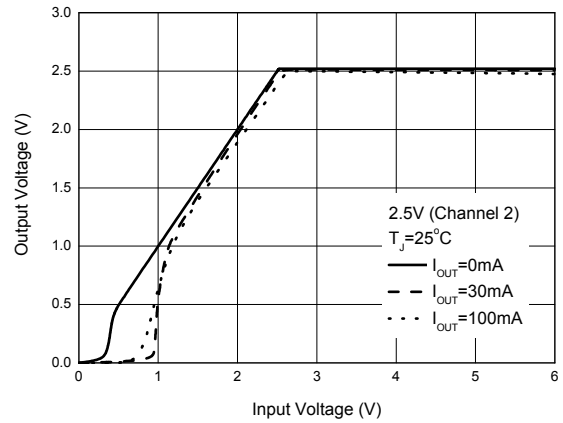

Figure 13. Output Voltage vs. Input Voltage

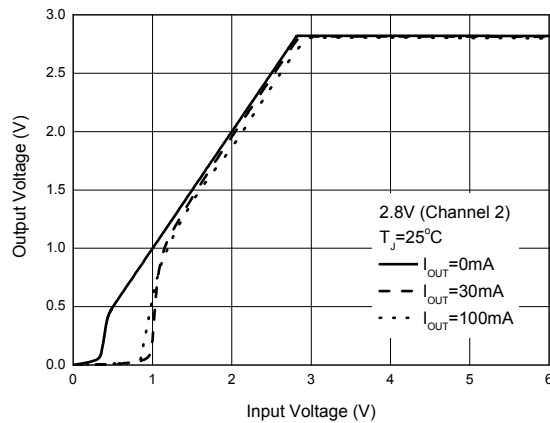

Figure 14. Output Voltage vs. Input Voltage

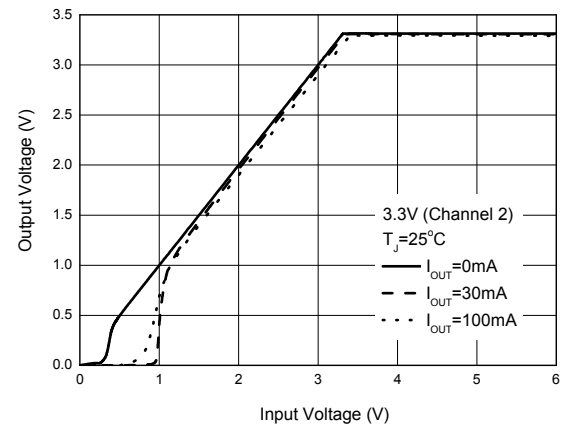

Figure 15. Output Voltage vs. Input Voltage



PART IS OBSOLETE
PLEASE USE AP7312

Data Sheet

200mA DUAL CHANNEL CMOS LDO REGULATOR

AP2401

Typical Performance Characteristics (Continued)

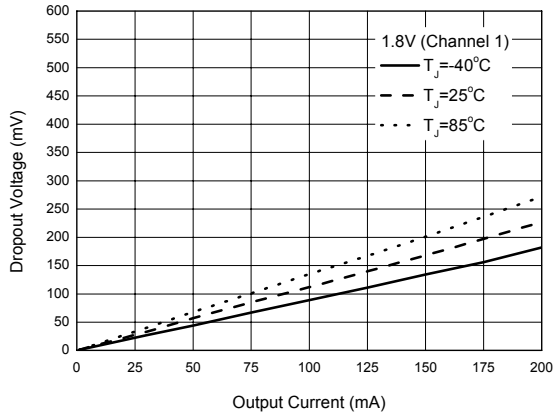

Figure 16. Dropout Voltage vs. Output Current

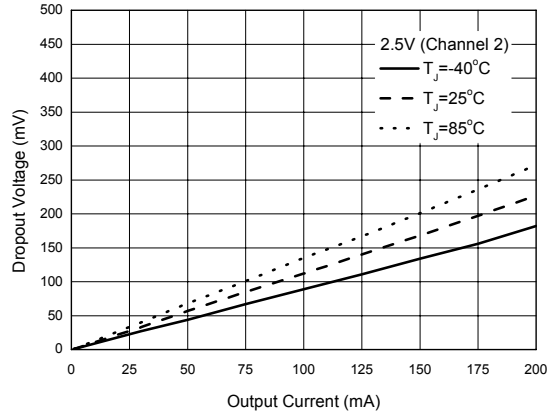

Figure 17. Dropout Voltage vs. Output Current

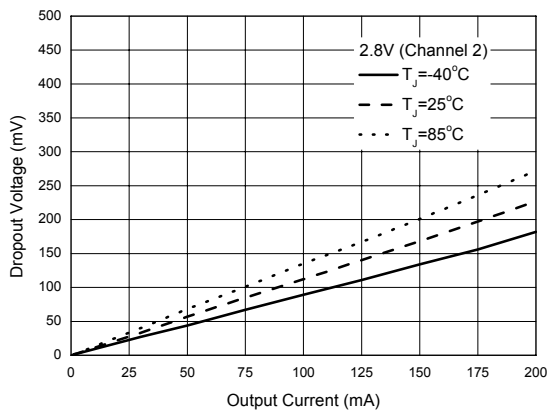

Figure 18. Dropout Voltage vs. Output Current

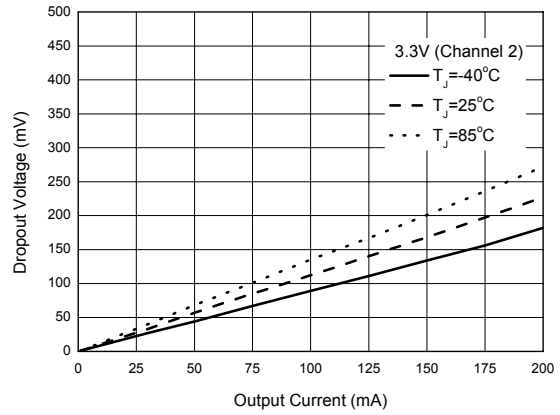

Figure 19. Dropout Voltage vs. Output Current



PART IS OBSOLETE
PLEASE USE AP7312

Data Sheet

200mA DUAL CHANNEL CMOS LDO REGULATOR

AP2401

Typical Performance Characteristics (Continued)

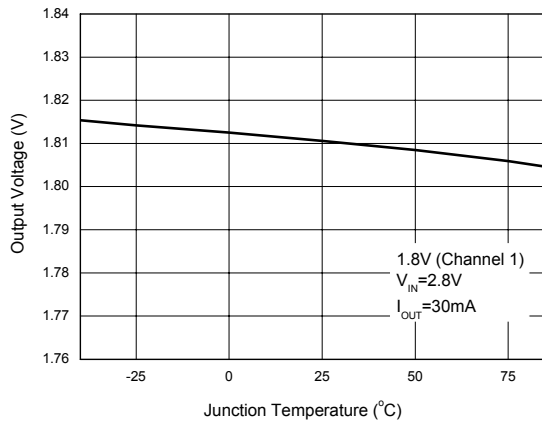

Figure 20. Output Voltage vs. Junction Temperature

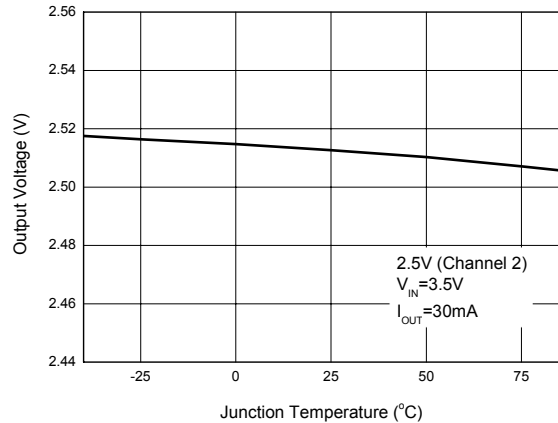

Figure 21. Output Voltage vs. Junction Temperature

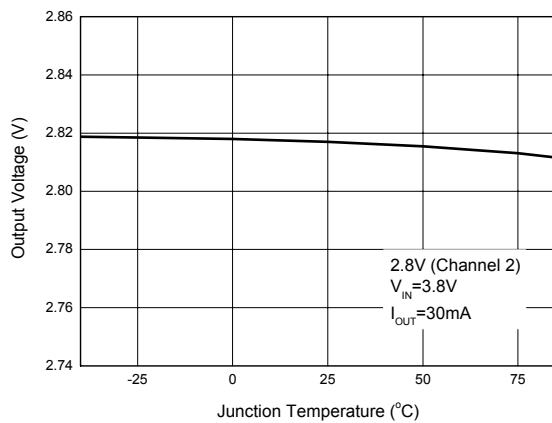

Figure 22. Output Voltage vs. Junction Temperature

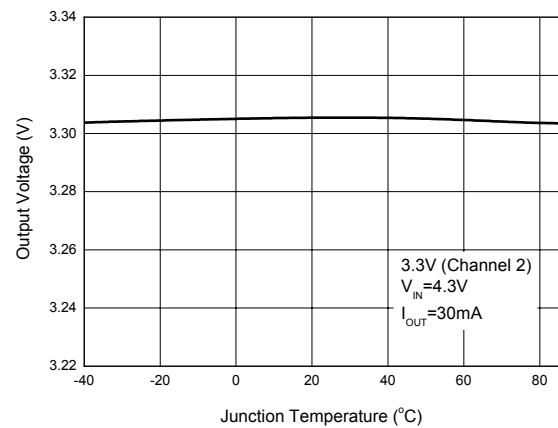

Figure 23. Output Voltage vs. Junction Temperature



PART IS OBSOLETE
PLEASE USE AP7312

Data Sheet

200mA DUAL CHANNEL CMOS LDO REGULATOR

AP2401

Typical Performance Characteristics (Continued)

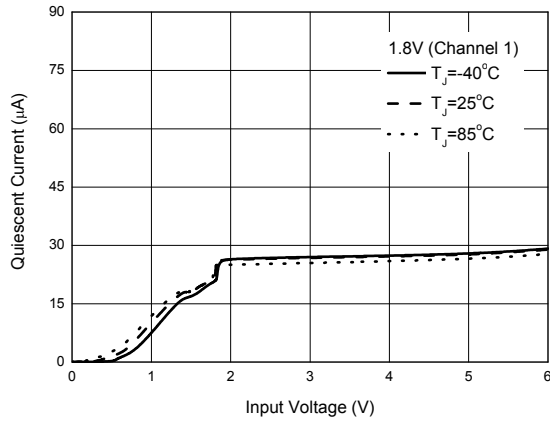

Figure 24. Quiescent Current vs. Input Voltage

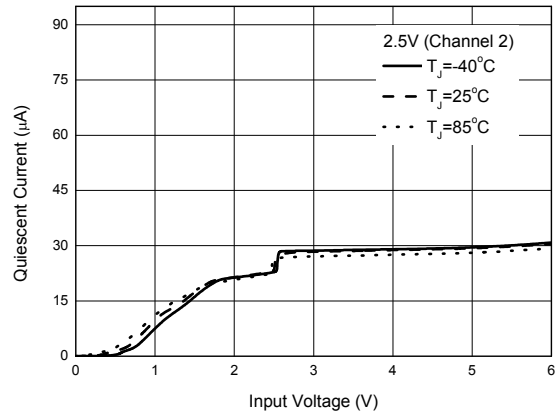

Figure 25. Quiescent Current vs. Input Voltage

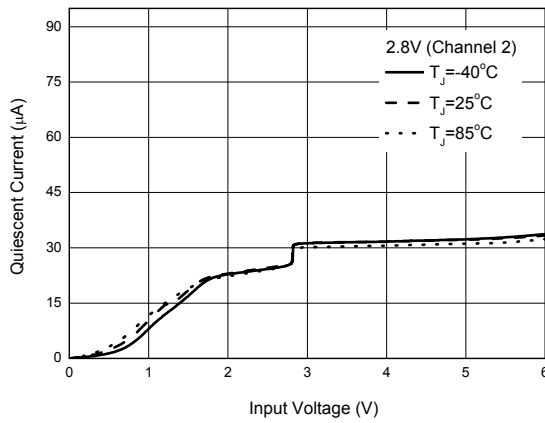

Figure 26. Quiescent Current vs. Input Voltage

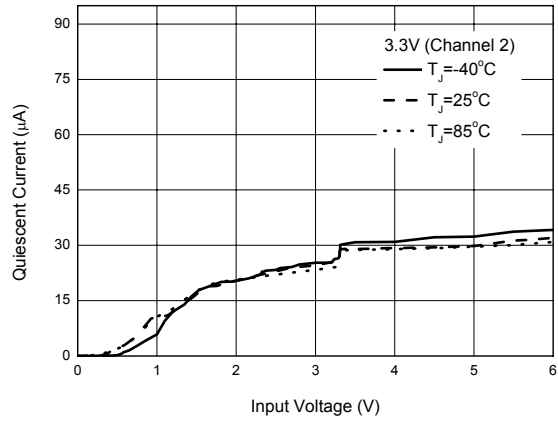

Figure 27. Quiescent Current vs. Input Voltage



PART IS OBSOLETE
PLEASE USE AP7312

Data Sheet

200mA DUAL CHANNEL CMOS LDO REGULATOR

AP2401

Typical Performance Characteristics (Continued)

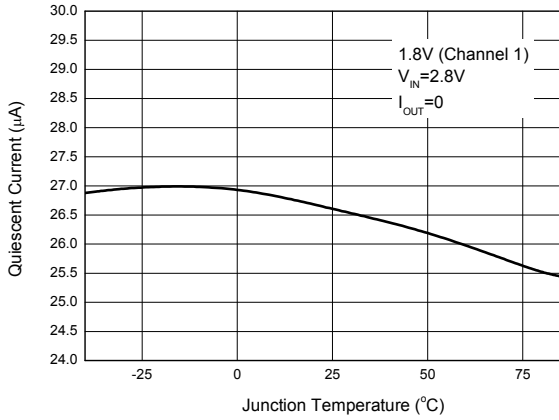

Figure 28. Quiescent Current vs. Junction Temperature

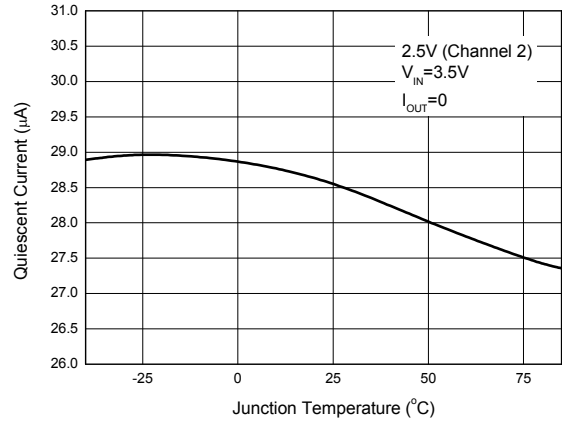

Figure 29. Quiescent Current vs. Junction Temperature

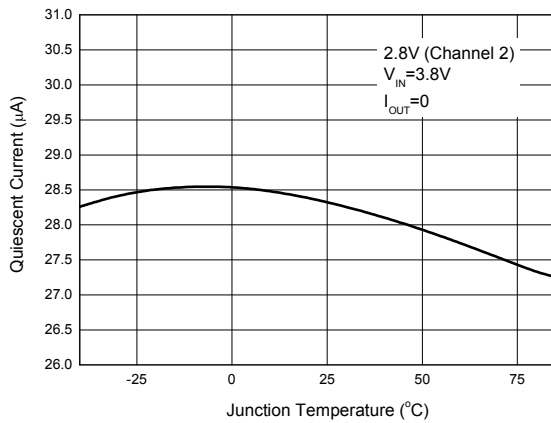

Figure 30. Quiescent Current vs. Junction Temperature

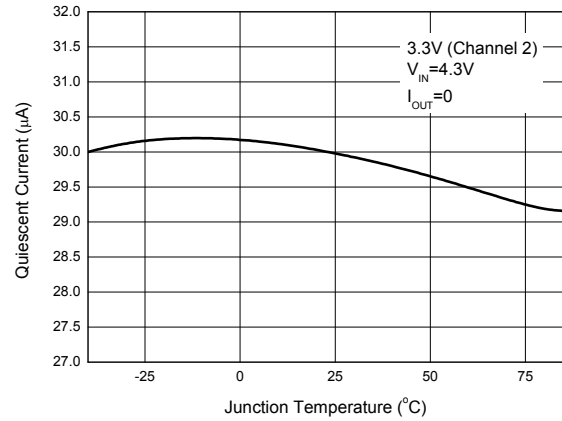

Figure 31. Quiescent Current vs. Junction Temperature



PART IS OBSOLETE
PLEASE USE AP7312

Data Sheet

200mA DUAL CHANNEL CMOS LDO REGULATOR

AP2401

Typical Performance Characteristics (Continued)

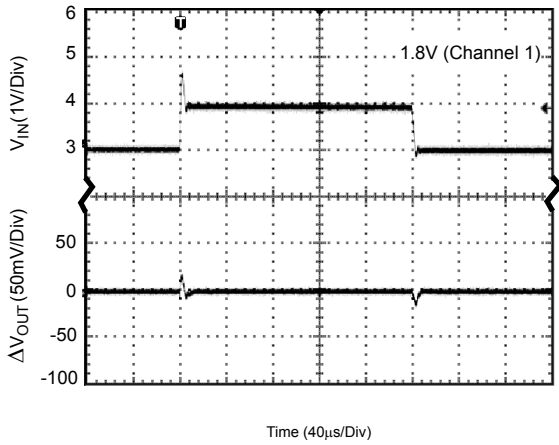

Figure 32. Line Transient
(Conditions: $I_{OUT}=30mA$, $C_{IN}=100nF$, $C_{OUT}=1\mu F$)

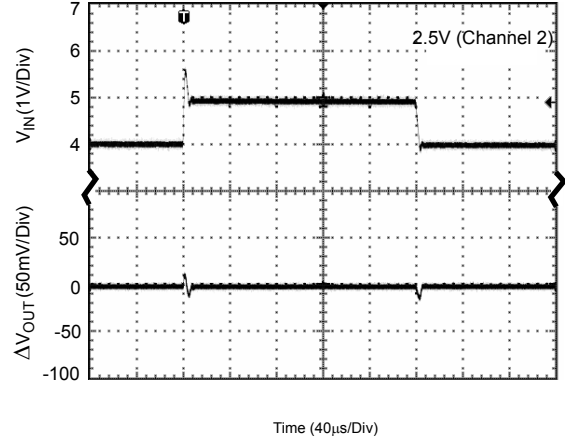

Figure 33. Line Transient
(Conditions: $I_{OUT}=30mA$, $C_{IN}=100nF$, $C_{OUT}=1\mu F$)

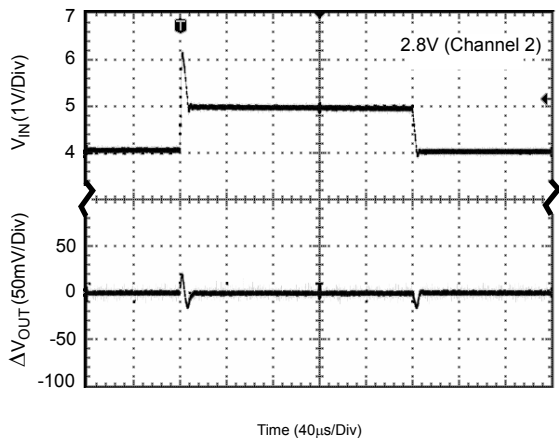

Figure 34. Line Transient
(Conditions: $I_{OUT}=30mA$, $C_{IN}=100nF$, $C_{OUT}=1\mu F$)

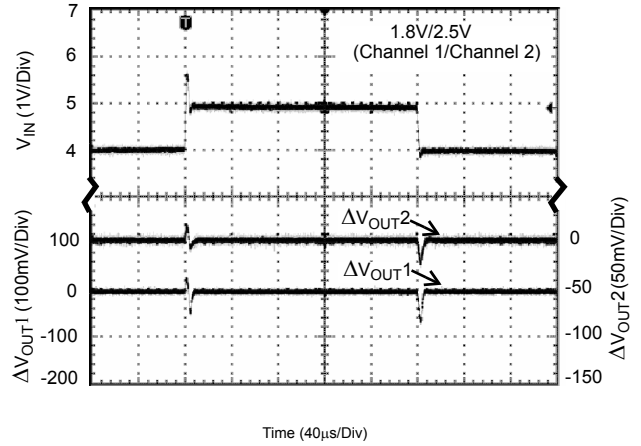

Figure 35. Line Transient
(Conditions: channel 1 and 2 on, $I_{OUT}=30mA$, $C_{IN}=100nF$, $C_{OUT}=1\mu F$)



PART IS OBSOLETE
PLEASE USE AP7312

Data Sheet

200mA DUAL CHANNEL CMOS LDO REGULATOR

AP2401

Typical Performance Characteristics (Continued)

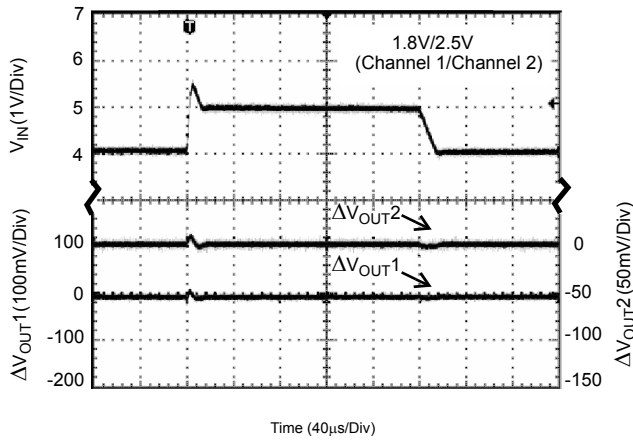

Figure 36. Line Transient

(Conditions: channel 1 and 2 on, $I_{OUT}=30mA$, $C_{IN}=C_{OUT}=1\mu F$)

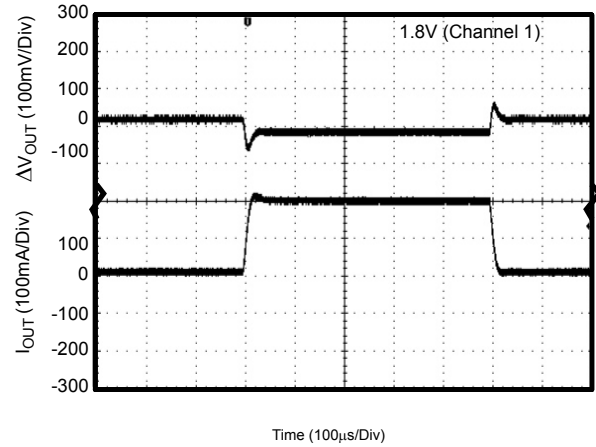

Figure 37. Load Transient

(Conditions: $I_{OUT}=10$ to 200mA, $C_{IN}=C_{OUT}=1\mu F$)

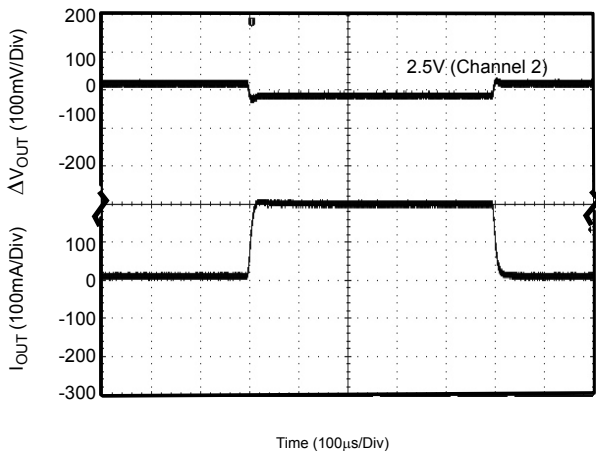

Figure 38. Load Transient

(Conditions: $I_{OUT}=10$ to 200mA, $C_{IN}=C_{OUT}=1\mu F$)

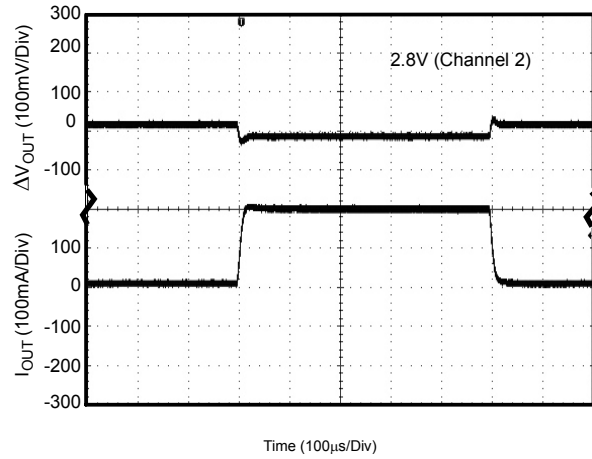

Figure 39. Load Transient

(Conditions: $I_{OUT}=10$ to 200mA, $C_{IN}=C_{OUT}=1\mu F$)



PART IS OBSOLETE
PLEASE USE AP7312

Data Sheet

200mA DUAL CHANNEL CMOS LDO REGULATOR

AP2401

Typical Performance Characteristics (Continued)

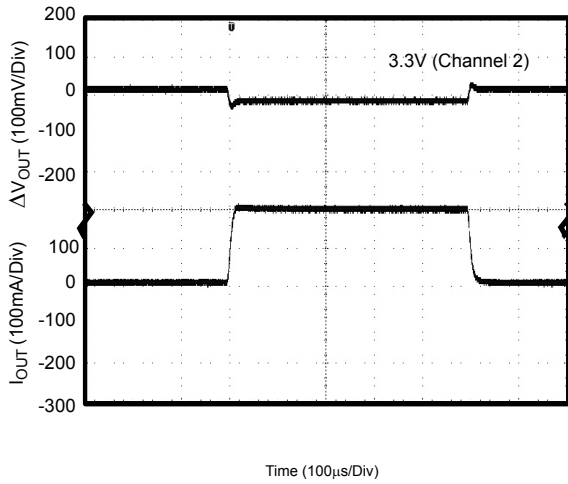

Figure 40. Load Transient
(Conditions: $I_{OUT}=10$ to 200mA , $C_{IN}=C_{OUT}=1\mu\text{F}$)

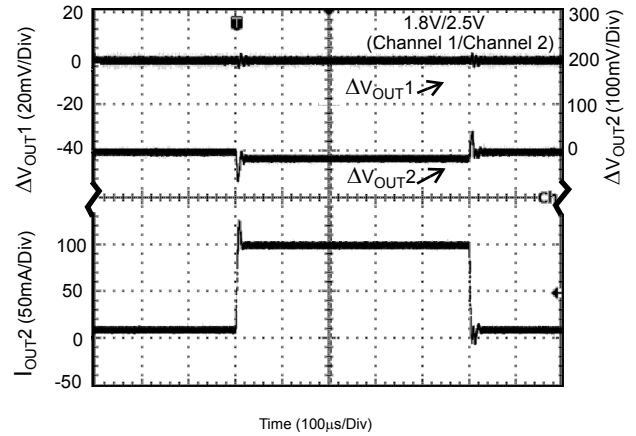

Figure 41. Cross Talk 1
(Conditions: channel 1 and 2 on, $I_{OUT1}=30\text{mA}$, $I_{OUT2}=10$ to 100mA , $C_{IN}=C_{OUT}=1\mu\text{F}$)

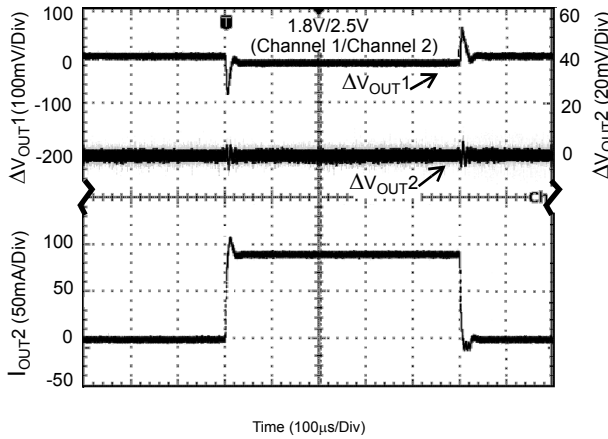

Figure 42. Cross Talk 2
(Conditions: channel 1 and 2 on, $I_{OUT1}=10$ to 100mA , $I_{OUT2}=30\text{mA}$, $C_{IN}=C_{OUT}=1\mu\text{F}$)

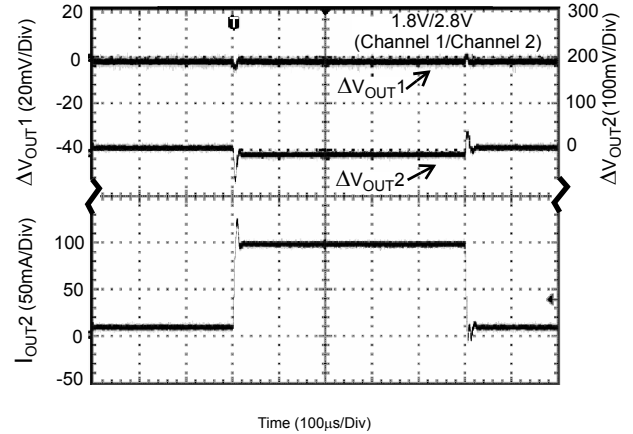

Figure 43. Cross Talk 3
(Conditions: channel 1 and 2 on, $I_{OUT1}=30\text{mA}$, $I_{OUT2}=10$ to 100mA , $C_{IN}=C_{OUT}=1\mu\text{F}$)



PART IS OBSOLETE
PLEASE USE AP7312

Data Sheet

200mA DUAL CHANNEL CMOS LDO REGULATOR

AP2401

Typical Performance Characteristics (Continued)

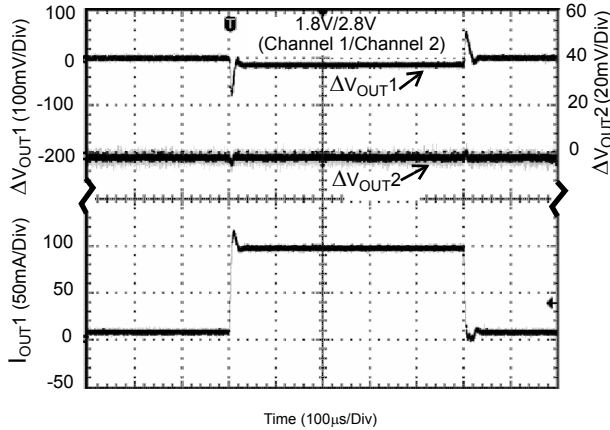

Figure 44. Cross Talk 4
(Conditions: channel 1 and 2 on, $I_{OUT1}=10$ to 100 mA,
 $I_{OUT2}=30$ mA, $C_{IN}=C_{OUT}=1\mu$ F)

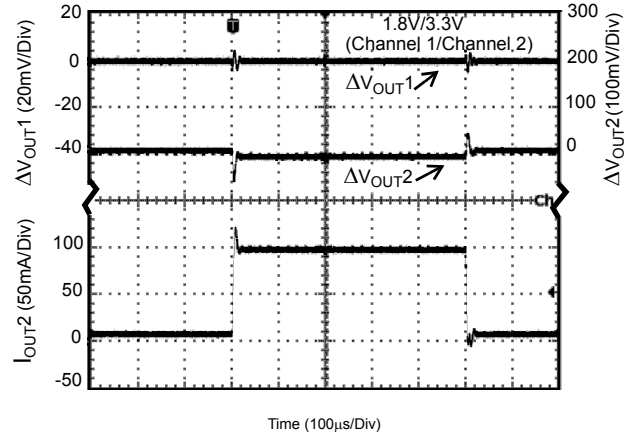

Figure 45. Cross Talk 5
(Conditions: channel 1 and 2 on, $I_{OUT1}=30$ mA,
 $I_{OUT2}=10$ to 100 mA, $C_{IN}=C_{OUT}=1\mu$ F)

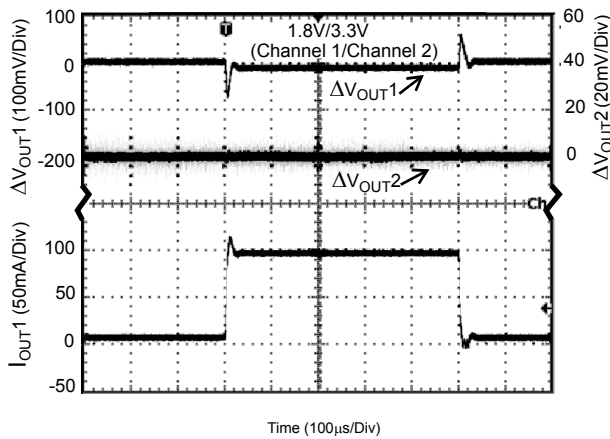

Figure 46. Cross Talk 6
(Conditions: channel 1 and 2 on, $I_{OUT1}=10$ to 100 mA,
 $I_{OUT2}=30$ mA, $C_{IN}=C_{OUT}=1\mu$ F)

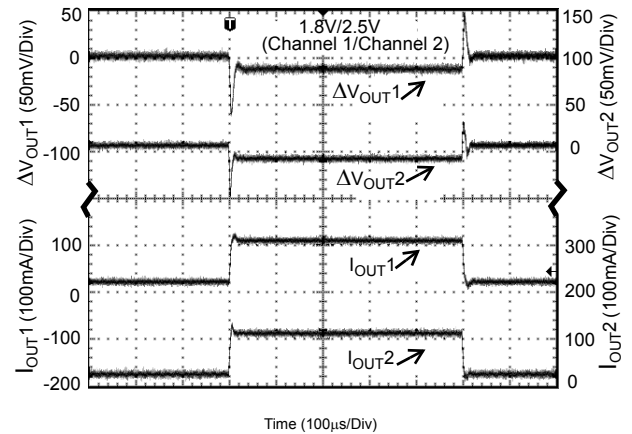

Figure 47. Cross Talk 7
(Conditions: channel 1 and 2 on, $I_{OUT1}=I_{OUT2}=10$ to 100 mA,
 $C_{IN}=C_{OUT}=1\mu$ F)



PART IS OBSOLETE
PLEASE USE AP7312

Data Sheet

200mA DUAL CHANNEL CMOS LDO REGULATOR

AP2401

Typical Performance Characteristics (Continued)

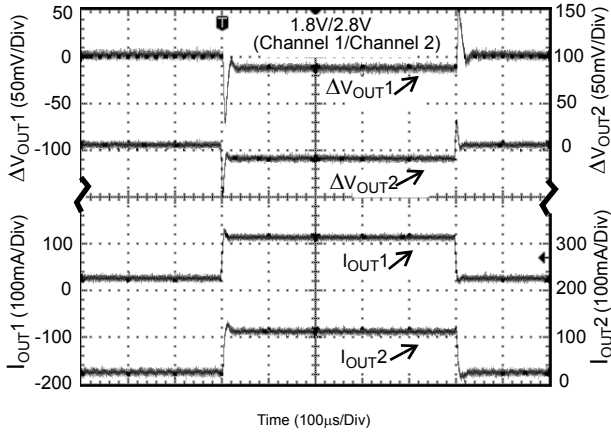

Figure 48. Cross Talk 8

(Conditions: channel 1 and 2 on, $I_{OUT1}=I_{OUT2}=10$ to 100 mA, $C_{IN}=C_{OUT}=1\mu$ F)

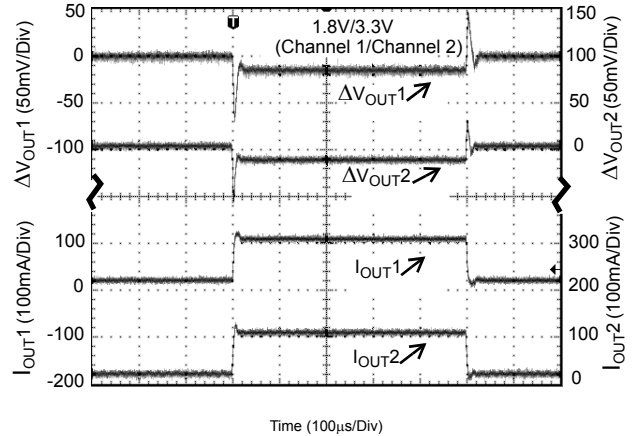

Figure 49. Cross Talk 9

(Conditions: channel 1 and 2 on, $I_{OUT1}=I_{OUT2}=10$ to 100 mA, $C_{IN}=C_{OUT}=1\mu$ F)

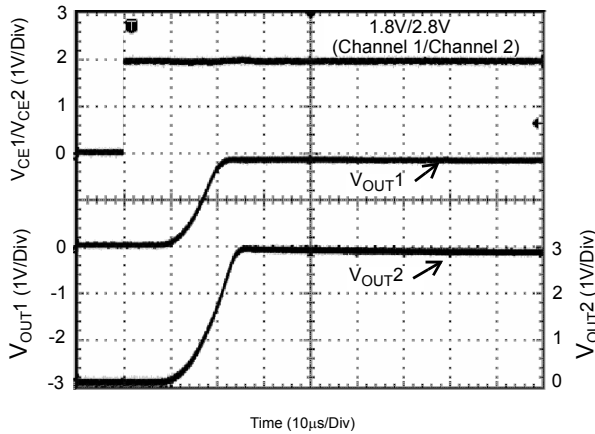

Figure 50. Enable Voltage vs. Output Voltage

(Conditions: $V_{CE1}=V_{CE2}=0$ to 2 V, $I_{OUT}=0$ mA, $C_{IN}=C_{OUT}=1\mu$ F)

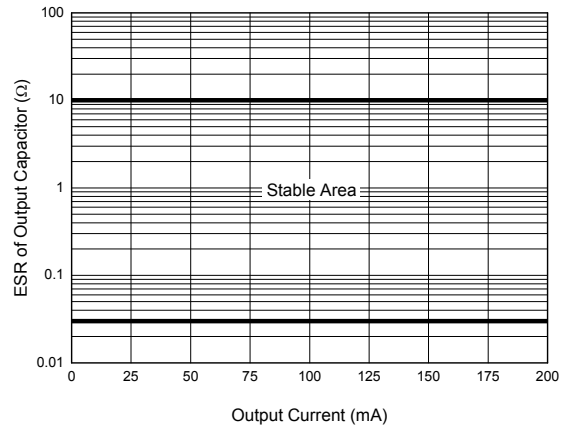

Figure 51. ESR vs. Output Current



PART IS OBSOLETE
PLEASE USE AP7312

Data Sheet

200mA DUAL CHANNEL CMOS LDO REGULATOR

AP2401

Typical Performance Characteristics (Continued)

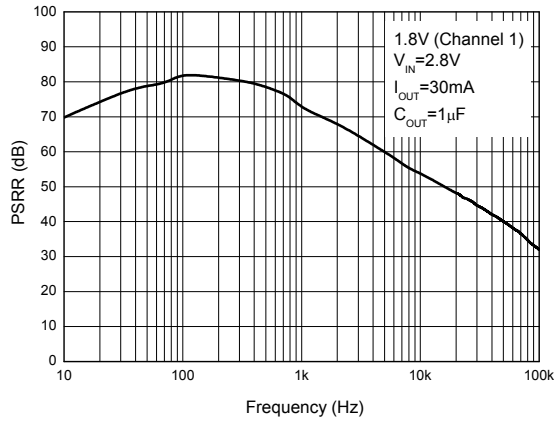

Figure 52. PSRR vs. Frequency

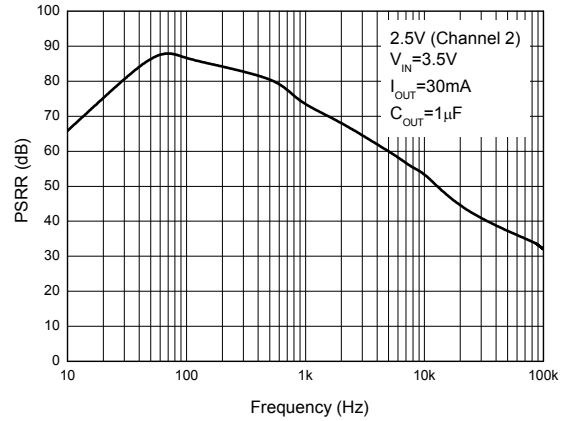

Figure 53. PSRR vs. Frequency

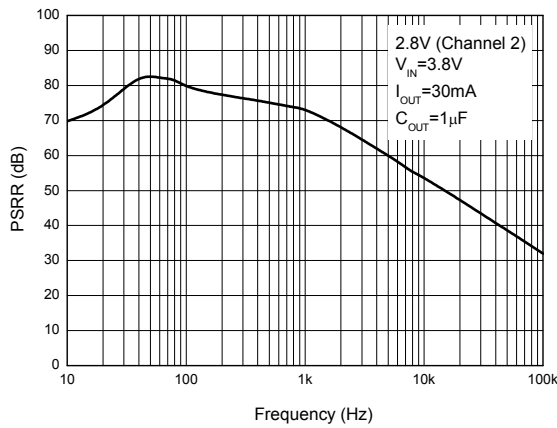

Figure 54. PSRR vs. Frequency

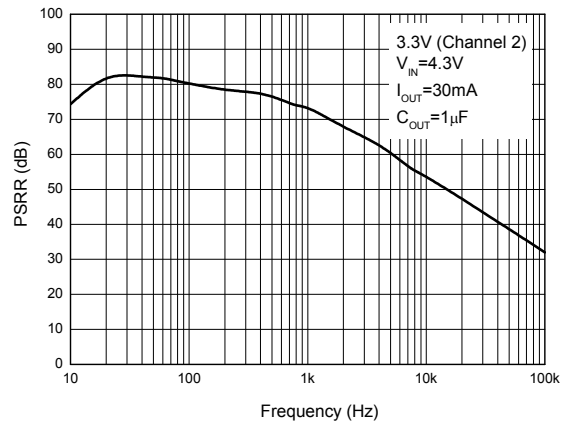

Figure 55. PSRR vs. Frequency



PART IS OBSOLETE
PLEASE USE AP7312

Data Sheet

200mA DUAL CHANNEL CMOS LDO REGULATOR

AP2401

Typical Application

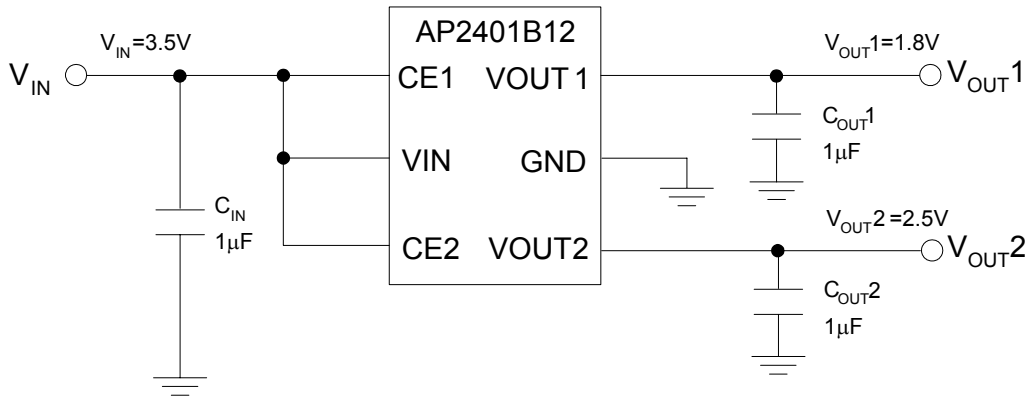

Figure 56. Typical Application of AP2401



PART IS OBSOLETE
PLEASE USE AP7312

Data Sheet

200mA DUAL CHANNEL CMOS LDO REGULATOR

AP2401

Mechanical Dimensions

SOT-23-6

Unit: mm(inch)

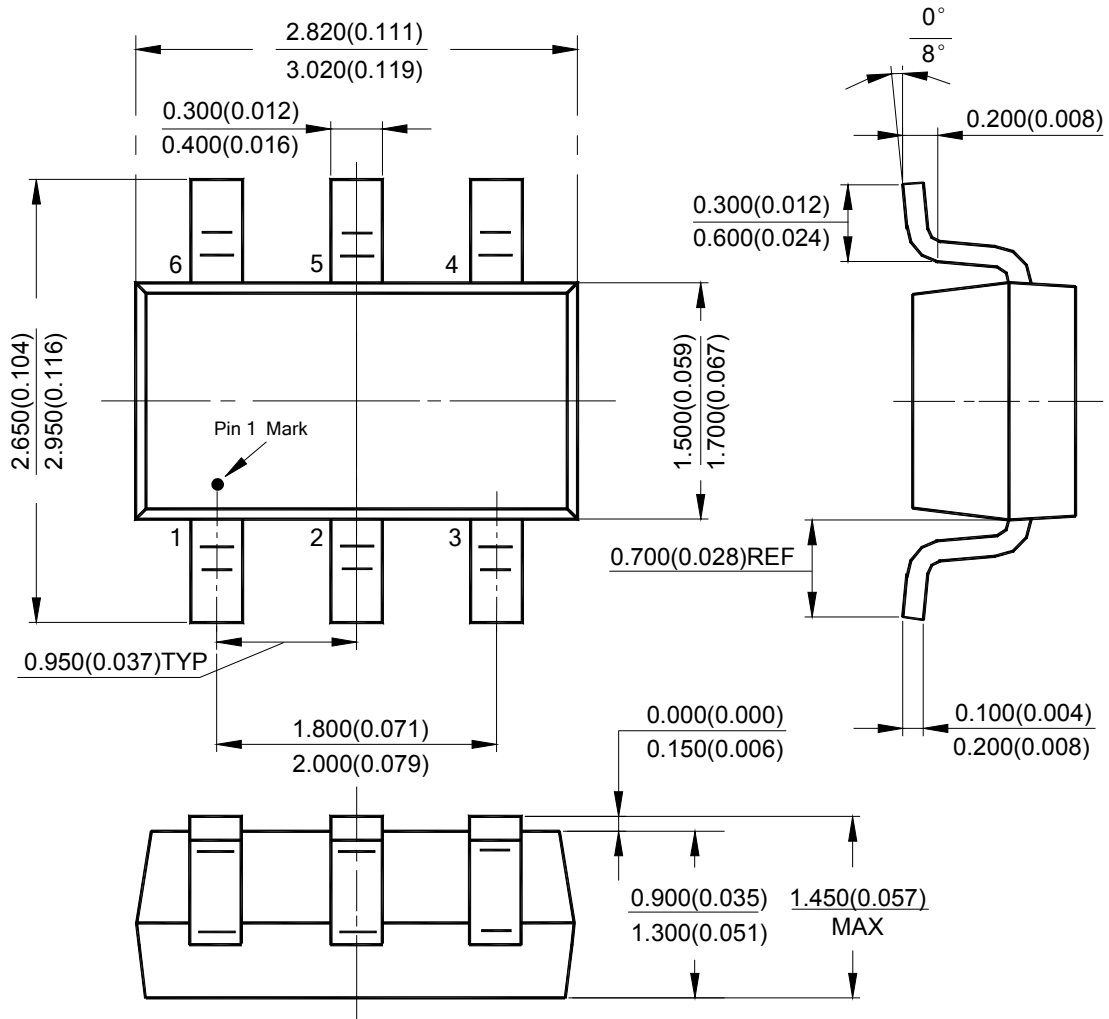



PART IS OBSOLETE
PLEASE USE AP7312

Data Sheet

200mA DUAL CHANNEL CMOS LDO REGULATOR

AP2401

Mechanical Dimensions (Continued)

DFN-1.8x2-6

Unit: mm(inch)

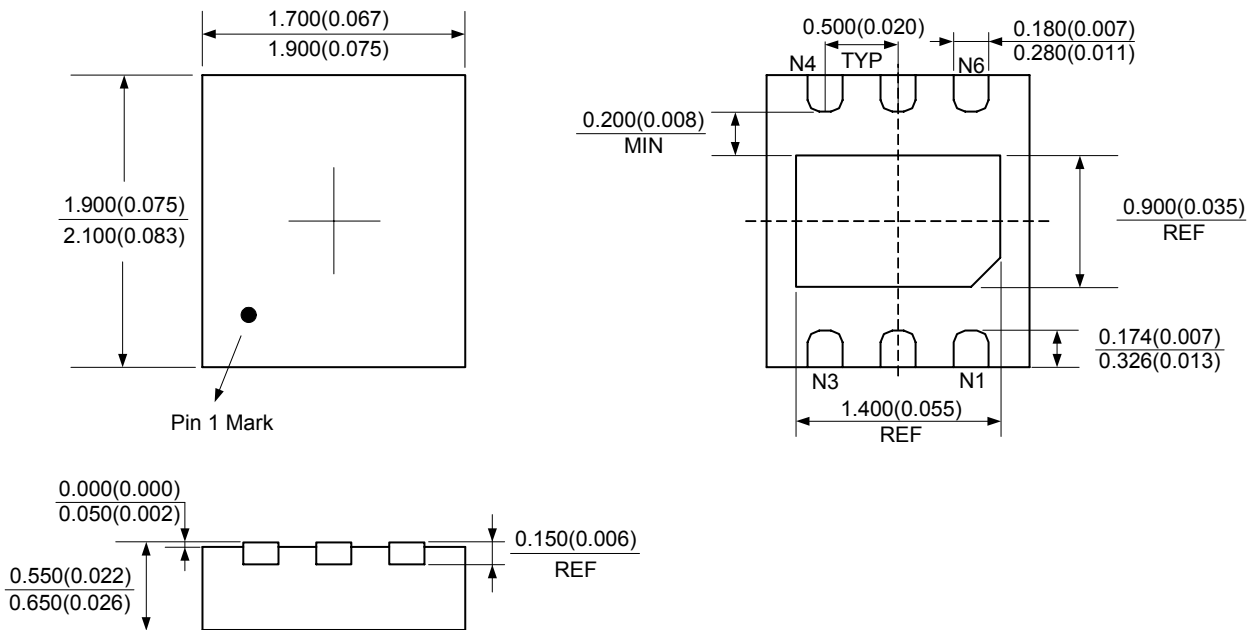

PART IS OBSOLETE
PLEASE USE AP7312



BCD Semiconductor Manufacturing Limited

<http://www.bcdsemi.com>

IMPORTANT NOTICE

BCD Semiconductor Manufacturing Limited reserves the right to make changes without further notice to any products or specifications herein. BCD Semiconductor Manufacturing Limited does not assume any responsibility for use of any its products for any particular purpose, nor does BCD Semiconductor Manufacturing Limited assume any liability arising out of the application or use of any its products or circuits. BCD Semiconductor Manufacturing Limited does not convey any license under its patent rights or other rights nor the rights of others.

MAIN SITE

- Headquarters

BCD Semiconductor Manufacturing Limited

No. 1600, Zi Xing Road, Shanghai Zizhu Science-based Industrial Park, 200241, China
Tel: +86-21-24162266, Fax: +86-21-24162277

- Wafer Fab

Shanghai SIM-BCD Semiconductor Manufacturing Co., Ltd.

800 Yi Shan Road, Shanghai 200233, China
Tel: +86-21-6485 1491, Fax: +86-21-5450 0008

REGIONAL SALES OFFICE

Shenzhen Office

Shanghai SIM-BCD Semiconductor Manufacturing Co., Ltd., Shenzhen Office

Unit A Room 1203, Skyworth Bldg., Gaoxin Ave. 1.S., Nanshan District, Shenzhen, China

Tel: +86-755-8826 7951
Fax: +86-755-8826 7865

Taiwan Office

BCD Semiconductor (Taiwan) Company Limited

4F, 298-1, Rui Guang Road, Nei-Hu District, Taipei, Taiwan

Tel: +886-2-2656 2808
Fax: +886-2-2656 2806

USA Office



BCD Semiconductor Corp.

30920 Huntwood Ave. Hayward, CA 94544, USA







Tel : +1-510-324-2988
Fax: +1-510-324-2788

Looking for pricing, stock, or lifecycle information?

Click below to explore more details on WIN SOURCE:

-  [View AP2401B34DNTR-G1 on WIN SOURCE](#)
-  [Diodes Incorporated Information](#)

Optimize Your Supply Chain with WIN SOURCE Solutions

-  Global Sourcing Solution
-  Obsolete Management
-  Cost Control Management
-  Shortage Management
-  Alternative Solution
-  Excess Inventory Management