



**THE DATASHEET OF  
DD100KB80**



# DIODE MODULE

## DD100KB

UL:E76102(M)

Power Diode Module **DD100KB** Series are designed for various rectifier circuits. **DD100KB** has two diode chips connected in series and the mounting base is electrically isolated from elements for simple heatsink construction. Wide voltage rating up to, 1600V is available for various input voltages.

- Isolated mounting base
- Two elements in a package for simple (single and three phase) bridge connections
- Highly reliable glass passivated chips
- High surge current capability

### (Applications)

- Various rectifiers, Battery chargers, DC motor drives

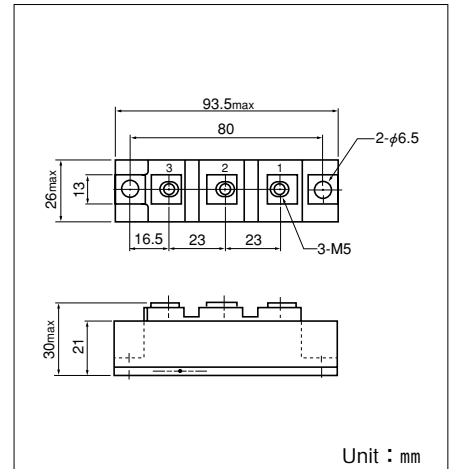
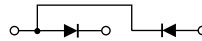

Unit : mm

### Maximum Ratings

(T<sub>j</sub>=25°C unless otherwise specified)

| Symbol           | Item                                | Ratings   |            | Unit |
|------------------|-------------------------------------|-----------|------------|------|
|                  |                                     | DD100KB80 | DD100KB160 |      |
| V <sub>RRM</sub> | Repetitive Peak Reverse Voltage     | 800       | 1600       | V    |
| V <sub>RSM</sub> | Non-Repetitive Peak Reverse Voltage | 960       | 1700       | V    |

| Symbol              | Item                                 | Conditions   | Ratings                           | Unit             |                 |
|---------------------|--------------------------------------|--|-----------------------------------|------------------|-----------------|
| I <sub>F(AV)</sub>  | Average Forward Current              | Single phase, half wave, 180°C conduction, T <sub>c</sub> =105°C | 100                               | A                |                 |
| I <sub>F(RMS)</sub> | R.M.S. Forward Current               | Single phase, half wave, 180°C conduction, T <sub>c</sub> =105°C | 155                               | A                |                 |
| I <sub>FSM</sub>    | Surge Forward Current                | ½cycle, 50/60Hz, peak value, non-repetitive                      | 1800/2000                         | A                |                 |
| I <sup>2</sup> t    | I <sup>2</sup> t                     | Value for one cycle of surge current                             | 16500                             | A <sup>2</sup> S |                 |
| T <sub>j</sub>      | Operating Junction Temperature       |  | -40 to +150                       | °C               |                 |
| T <sub>stg</sub>    | Storage Temperature                  |  | -40 to +125                       | °C               |                 |
| V <sub>ISO</sub>    | Isolation Breakdown Voltage (R.M.S.) | A.C. 1minute   | 2500                              | V                |                 |
|                     | Mounting Torque                      | Mounting (M6)  | Recommended Value 2.5-3.9 (25-40) | 4.7 (48)         | N·m<br>(kgf·cm) |
|                     |                                      | Terminal (M5)  | Recommended Value 1.5-2.5 (15-25) | 2.7 (28)         |                 |
|                     | Mass                                 | Typical Value  | 170                               | g                |                 |

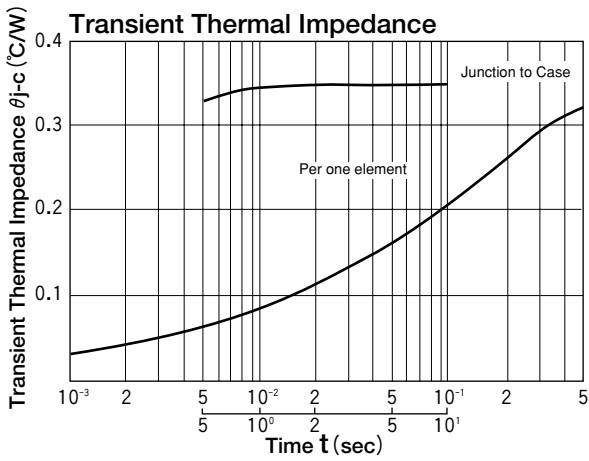
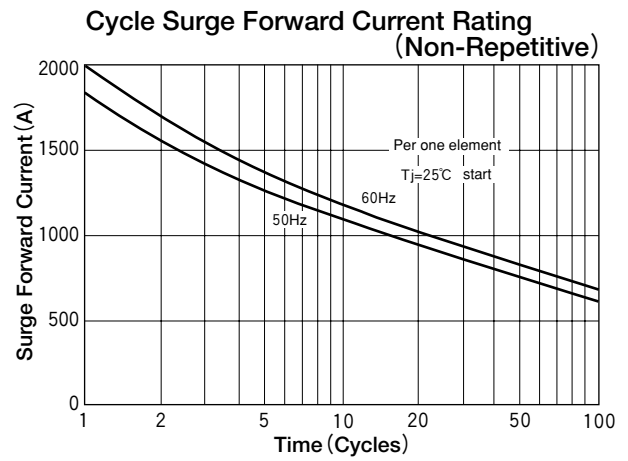
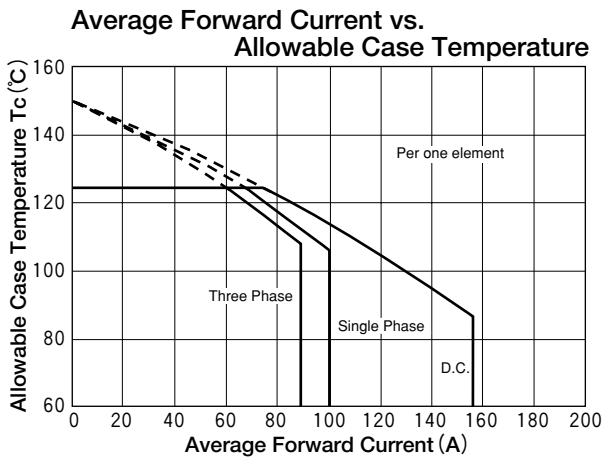
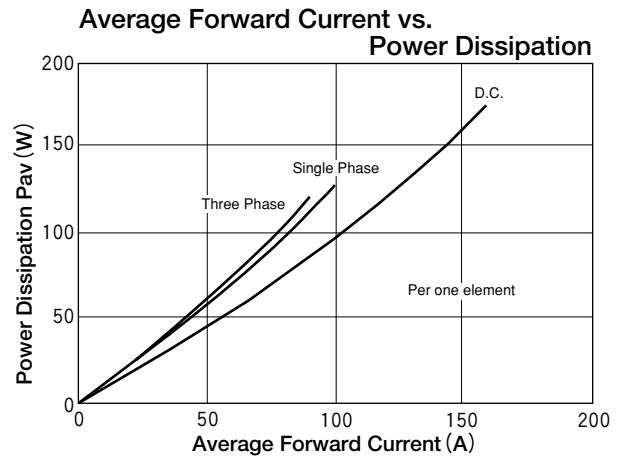
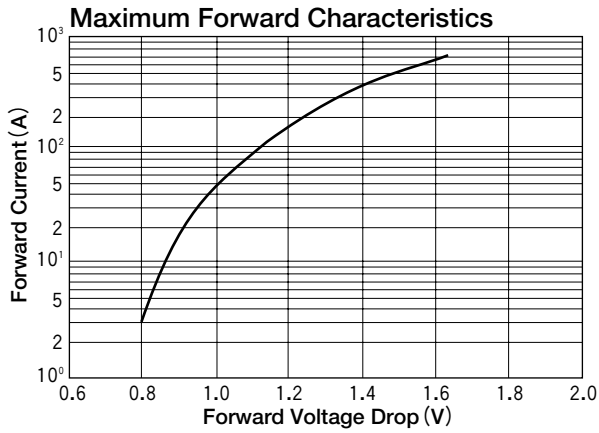

### Electrical Characteristics

| Symbol               | Item                                  | Conditions   | Ratings | Unit |
|----------------------|---------------------------------------|--|---------|------|
| I <sub>RRM</sub>     | Repetitive Peak Reverse Current, max. | at V <sub>RRM</sub> Single phase, half wave, T <sub>j</sub> =150°C | 30      | mA   |
| V <sub>FM</sub>      | Forward Voltage Drop, max.            | Forward current 320A, Inst measurement                             | 1.35    | V    |
| R <sub>th(j-c)</sub> | Thermal Impedance, max.               | Junction to case   | 0.35    | °C/W |



## Looking for pricing, stock, or lifecycle information?

Click below to explore more details on WIN SOURCE:

-  [View DD100KB80 on WIN SOURCE](#)
-  [SanRex Corporation](#) Information

## Optimize Your Supply Chain with WIN SOURCE Solutions

-  Global Sourcing Solution
-  Obsolete Management
-  Cost Control Management
-  Shortage Management
-  Alternative Solution
-  Excess Inventory Management