



**THE DATASHEET OF
AP6015-18M10G-13**



Features

- High efficiency synchronous step-down converter with greater than 94%
- Current Mode Operation for faster transient response and better loop stabilization
- 2.5V to 5.5V operating input voltage range
- Adjustable output voltage range from 0.8V to V_{IN}
- Fixed output voltage options: 1.8V, 2.5V and 3.3V
- Up to 800mA output current
- High efficiency over a wide range of load currents
- PWM operation mode
- Internal soft-start function
- Typical quiescent current of 150 μ A
- MSOP-10L: Available in "Green" Molding Compound (No Br, Sb)
- Lead Free Finish/ RoHS Compliant (Note 1)

General Description

The AP6015 is the first device in a family of low-noise current mode synchronous step-down DC-DC converters. It is ideally suited for systems powered by either a 1-cell Li-ion battery or a 2- to 3-cell NiCd/ NiMH/ Alkaline battery.

The AP6015 is a synchronous PWM converter with integrated N- and P-channel power MOSFET switches. Compared to the asynchronous topology, synchronous rectification offers the benefits of higher efficiency and reduced component count. The high operating frequency of 1MHz allows small inductor and capacitor to be used. This results in small pcb area. During shut-down, the standby current drops to 1 μ A or less. The AP6015 is available in the 10-pin MSOP package. It operates over a free-air temperature range of -40°C to 85°C.

Applications

- Mobile Handsets
- PDAs, Ultra Mobile PCs
- Portable Media Players, Digital Still/Video Cameras
- USB-based DSL Modems
- LAN/WLAN/WPAN/WWAN Modules

Ordering Information

AP 6015 - XX M10 G - 13

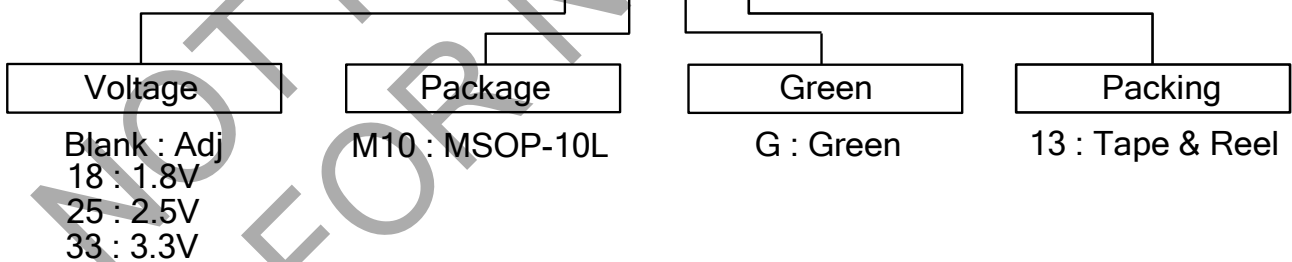

Device	Package Code	Packaging (Note 2)	13" Tape and Reel	
			Quantity	Part Number Suffix
AP6015-XXM10G-13	M10	MSOP-10L	2500/Tape & Reel	-13

Notes: 1. EU Directive 2002/95/EC (RoHS). All applicable RoHS exemptions applied, see *EU Directive 2002/95/EC Annex Notes*.
 2. Pad layout as shown on Diodes Inc. suggested pad layout document AP02001, which can be found on our website at <http://www.diodes.com/datasheets/ap02001.pdf>.

Pin Assignment

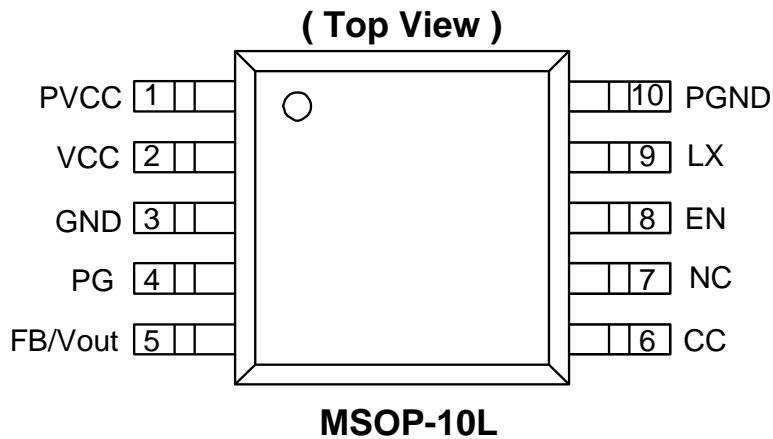

Pin Descriptions

Pin Name	Pin NO.	I/O	Description
PVCC	1	I	Supply voltage input
VCC	2		Supply bypass pin. A 1 μ F coupling capacitor should be connected as close as possible to this pin.
GND	3		Ground
PG	4	O	Power good comparator output. A pull-up resistor should be connected between PG and V _o .
FB	5	I	Feedback pin for the fixed output voltage option.
CC	6	I	Compensation pin
NC	7	NC	No connect
EN	8	I	Enable.Pin, H: Enable. L:shutdown
LX	9	I/O	Connect the inductor to this pin.
PGND	10		Power ground

Block Diagram

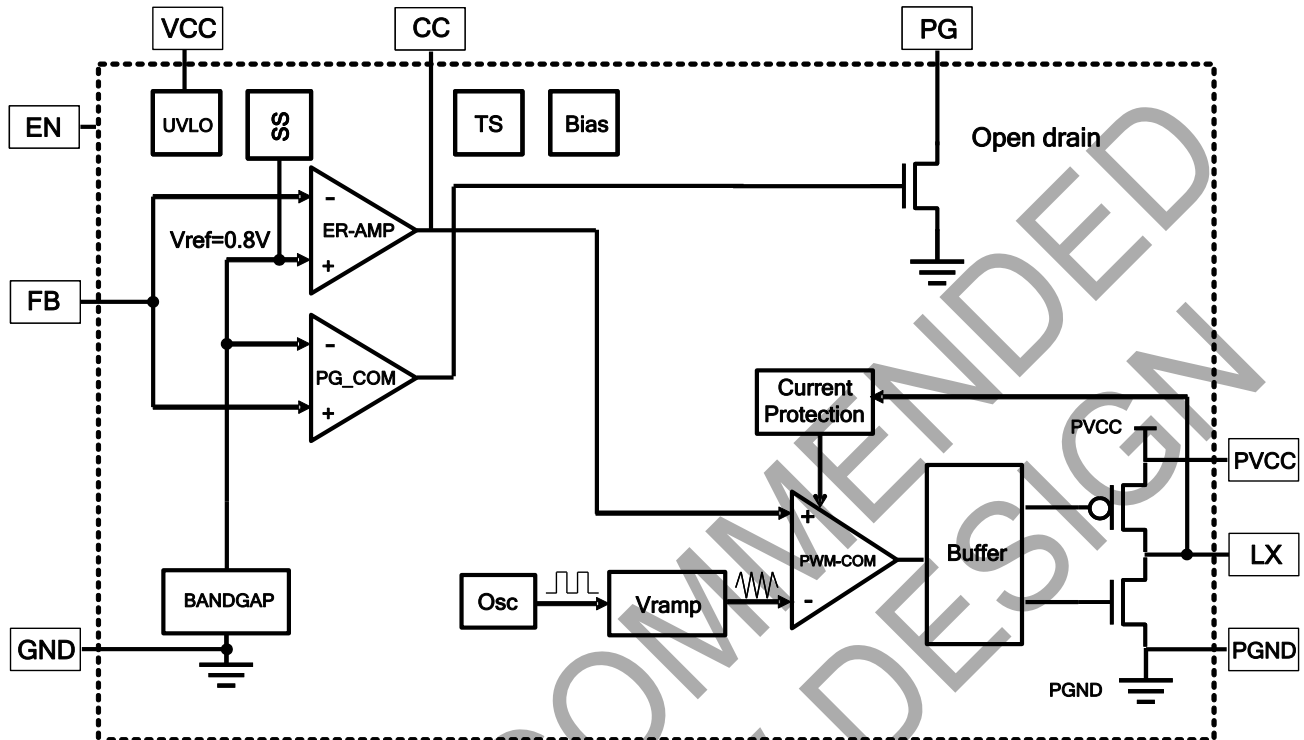

Notes: 3. The adjustable output voltage version does not use the internal feedback resistor divider. The FB pin is directly connected to the error amplifier.

Absolute Maximum Ratings

Symbol	Parameter	Rating	Unit
ESD HBM	Human Body Model ESD Protection	2.5	KV
ESD MM	Machine Model ESD Protection	300	V
PVCC, VCC	Supply Voltage	-0.3 to +5.5	V
	Voltages on pins EN, CC, PG, FB, LX	-0.3 to $V_{IN} + 0.3$	V
$T_{J(MAX)}$	Maximum Junction Temperature Range	+150	°C
T_{ST}	Storage temperature range	-65 to +150	°C
T_{OP}	Operating Junction Temperature Range	-40 to +125	°C

Stresses beyond those listed under "absolute maximum ratings" may cause permanent damage to the device. These are stress ratings only and functional operation of the device at these or any other conditions beyond those indicated under "recommended operating conditions" is not implied. Exposure to absolute-maximum-rated conditions for extended periods may affect device reliability.

Recommended Operating Conditions (T_A :-40~85°C)

Symbol	Parameter	Rating	Unit
T _A	Operating Ambient Temperature Range	-40 to +85	°C
V _{IN}	Supply Voltage	2.0 to 5.5	V
V _O	Output voltage range for adjustable output voltage version	0.8 to V _I	V
L	Inductor (see Note 4)	3.3	μH
C _i	Input capacitor (see Note 4)	10	μF
C _o	Output capacitor (see Note 4) V _O ≥ 1.8V	10	μF

Notes: 4. Refer to application section for further information.

Electrical Characteristics (T_A =25°C)

Over recommended operating free-air temperature range, V_I=3.6V, V_O=2.5V, I_O=300mA, EN=V_{IN}. (unless otherwise noted)

Symbol	Parameter	Conditions	Min	Typ.	Max	Unit	
Supply current							
V _{IN}	Input Voltage range	-20 to 85 °C	I _O = 0mA to 800mA	2.5	-	5.5	V
			I _O = 0mA to 500mA	2	-	5.5	
		-40 to 85 °C	I _O = 0mA to 600mA	2.5	-	5.5	
			I _O = 0mA to 400mA	2	-	-	
I _{CCQ}	Operating quiescent current	I _O = 0mA	-	150	-	μA	
I _{STBY}	Standby current	EN= GND	-	0.1	1	μA	
Enable							
V _{IH}	EN high-level input voltage	V _{IN} ≤ 3V	1.5	-	-	V	
		V _{IN} > 3V	2.5	-	-		
V _{IL}	EN low-level input voltage		-	-	0.7	V	
I _L	EN input leakage current	EN= GND or V _{IN}	-	0.01	0.1	μA	
V _(UVLO)	Under-voltage-lockout-threshold		1.2	1.6	1.95	V	

Electrical Characteristics (Continued)

Over recommended operating free-air temperature range, $V_I=3.6V$, $V_O=2.5V$, $I_O=300mA$, $EN=V_{IN}$. (unless otherwise noted)

Symbol	Parameter	Conditions	Min	Typ.	Max	Unit	
Power switch and current limit							
$R_{DS(on)}$	P-channel MOSFET on-resistance	$V_I=V_{GS}=3.6V$; $I=200mA$	200	280	410	m Ω	
	P-channel leakage current	$V_I=V_{GS}=2V$; $I=200mA$	-	480	-		
	N-channel MOSFET on-resistance	$V_I=V_{GS}=3.6V$; $I_O=200mA$	200	280	410	m Ω	
	N-channel leakage current	$V_I=V_{GS}=2V$; $I_O=200mA$	-	500	-		
$I_{(LIM)}$	P-channel current limit	$2.5V \leq V_I \leq 5.5V$	1200	-	1600	mA	
Power good output (see Note 5)							
$V_{(PG)}$	Power good threshold	Feedback voltage falling	88% V_O	92% V_O	94% V_O	V	
	Power good hysteresis		2.5% V_O				
V_{OL}	PG output low voltage	$V_{(FB)}=0.8 \times V_O$ nominal; $I_{(sink)}=10\mu A$	-	-	0.3	V	
I_{LKG}	PG output leakage current	$V_{(FB)}=V_O$ nominal		0.01	1	μA	
	Minimum supply voltage for valid power good signal		1.2	-	-	V	
Oscillator							
F_S	Oscillator frequency		800	1000	1200	KHz	
Output							
V_O	Adjustable output voltage range		0.8		5.5	V	
V_{REF}	Reference voltage		0.784	0.8	0.816	V	
V_O	Fixed output voltage (see Note 6)	AP6015-Adj	$V_I=2.5V$ to $5.5V$; $0mA \leq I_O \leq 800mA$	-3%	-	4%	V
		AP6015-1.8V	$10mA \leq I_O \leq 800mA$	-3%	-	3%	
		AP6015-2.5V	$V_I=2.7V$ to $5.5V$; $0mA \leq I_O \leq 800mA$	-3%	-	4%	
			$10mA \leq I_O \leq 800mA$	-3%	-	3%	
		AP6015-3.3V	$V_I=3.6V$ to $5.5V$; $0mA \leq I_O \leq 800mA$	-3%	-	4%	
		$10mA \leq I_O \leq 800mA$	-3%	-	3%		
	Line regulation	$V_I=V_O + 0.5V$ (min.2V) to 6.0V; $I_O=10mA$	0.3			%/V	
	Load regulation	$V_I=5.0V$; $I_O=10mA$ to 800mA	0.8			%	
η	Efficiency	$V_I=5V$; $V_O=3.3V$; $I_O=300mA$ $V_I=3.6V$; $V_O=2.5V$; $I_O=200mA$	94			%	
	Start-up time	$I_O=0mA$, time from active EN to V_O	0.4	1	4	ms	
θ_{JA}	Thermal Resistance Junction-to-Ambient	MSOP-10L (Note 7)		161		$^{\circ}C/W$	
θ_{JC}	Thermal Resistance Junction-to-Case	MSOP-10L (Note 7)		39		$^{\circ}C/W$	

Notes: 5. Power good is not valid for the first 100 μs after EN goes high. Please refer to the application section for more information.

6. The output voltage accuracy includes line and load regulation over the full temperature range.

7. Test condition for MSOP-10L: Device mounted on 2oz copper, minimum recommended pad layout on top & bottom layer with thermal vias, double sided FR-4 PCB

Typical Application Circuit

For best transient response we suggest that R_{CC} , C_{CC} and $L1$ values as below.

	R_{CC}	C_{CC}	L1-WURTH	C1, C2 (MLCC)
$V_{IN} < 3.0V, V_{OUT} < 2.5V$	200K Ω	33PF	1.8 μ H	10 μ F
$V_{IN} \geq 3.0V, V_{OUT} < 2.5V$	68K Ω	100PF	1.8 μ H	10 μ F
$V_{IN} \geq 3.0V, V_{OUT} \geq 2.5V$	82K Ω	100PF	3.3 μ H	10 μ F

(1) ADJ Output

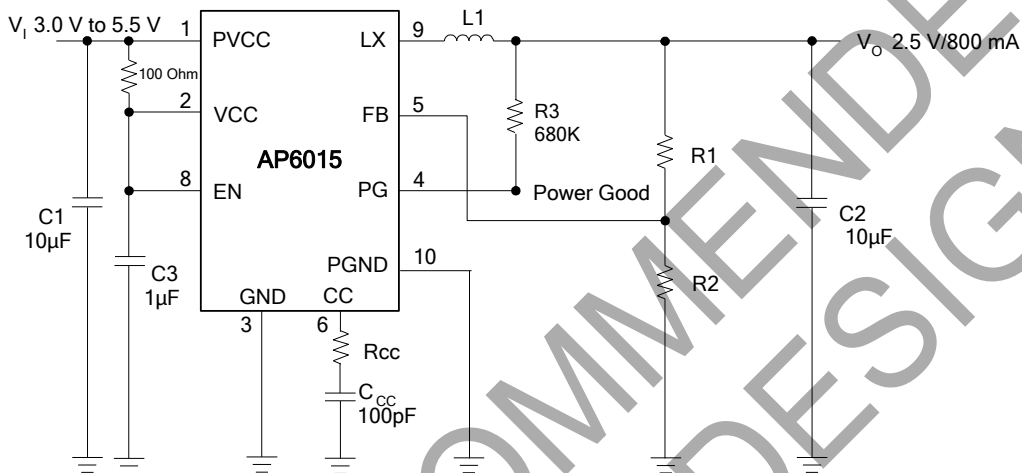

R2: Suggest to be 39K~100K because of stability reasons.

$$V_o = V_{REF} \times \left(1 + \frac{R_1}{R_2}\right)$$

Typical Application Circuit for Adjustable Output Voltage Option

(2) FIXED Output

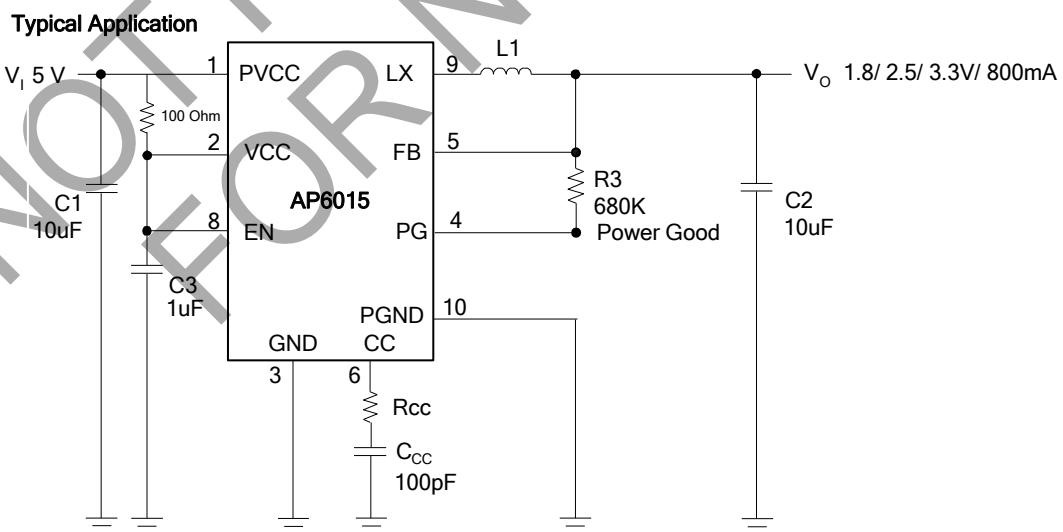

Standard 5 V to 1.8/ 2.5/ 3.3V/ 800mA Conversion; High Efficiency

Typical Operating Characteristics

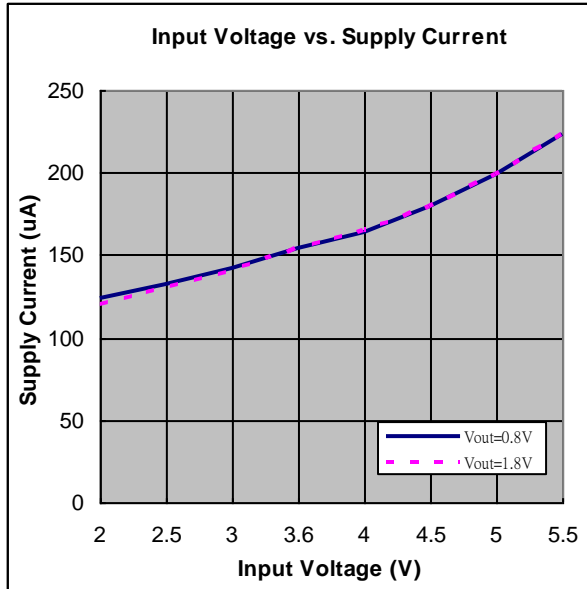

Figure 1

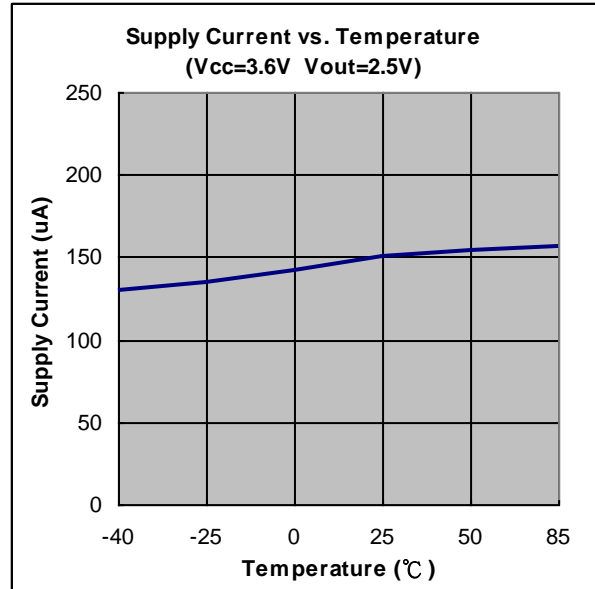

Figure 2

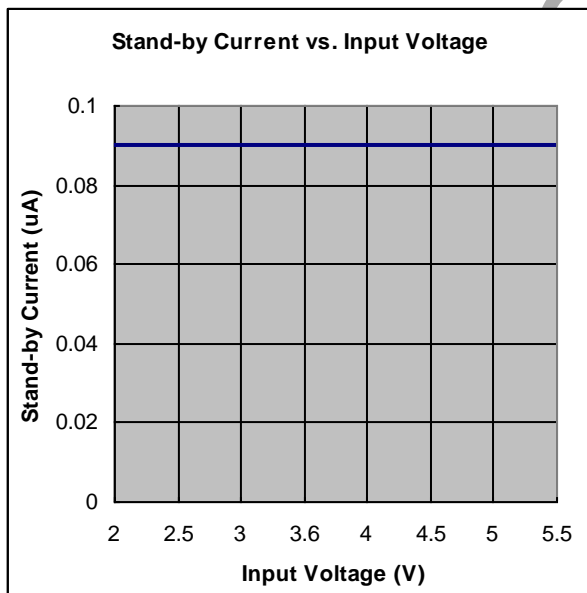

Figure 3

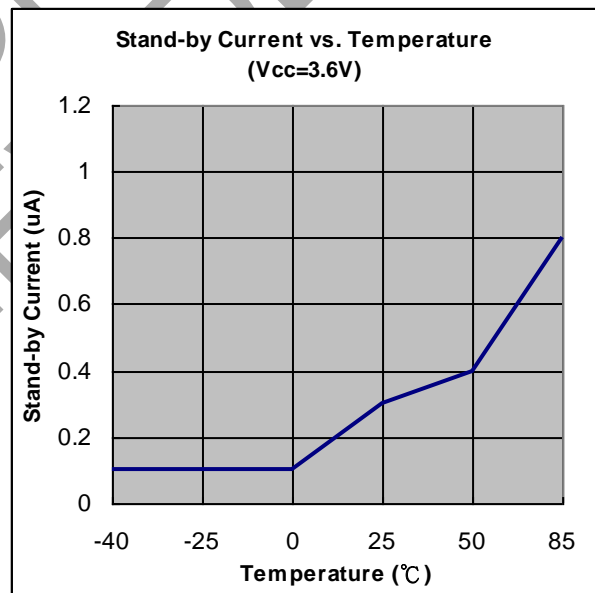

Figure 4

Typical Operating Characteristics (Continued)

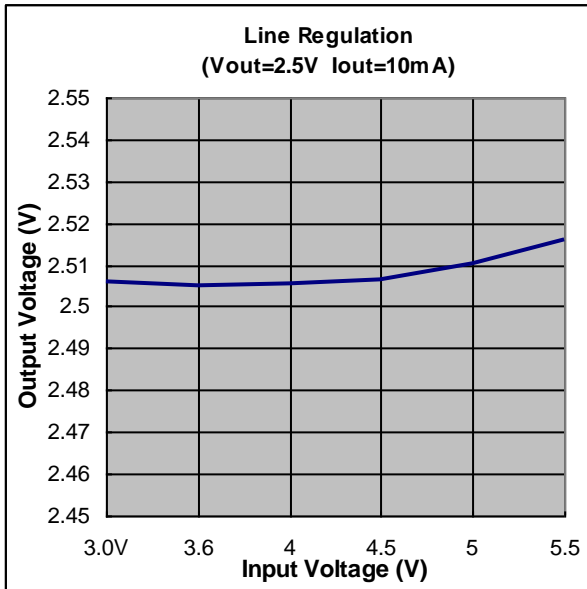

Figure 5

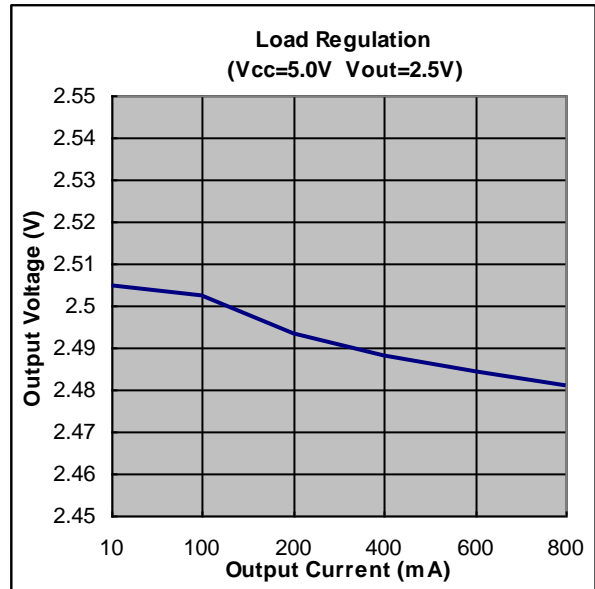

Figure 6

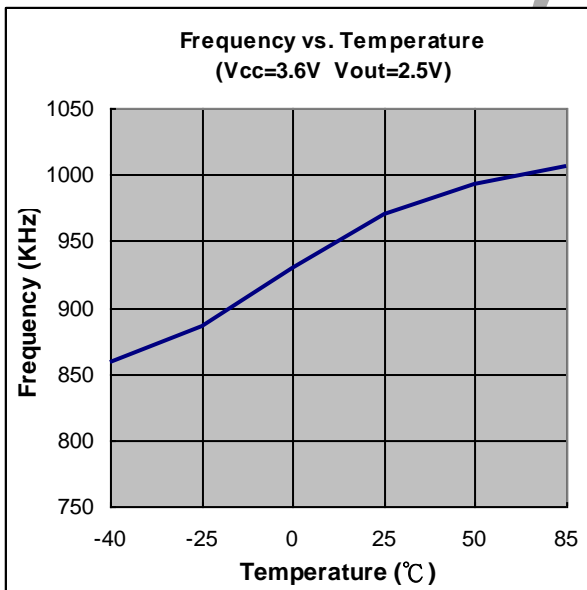

Figure 7

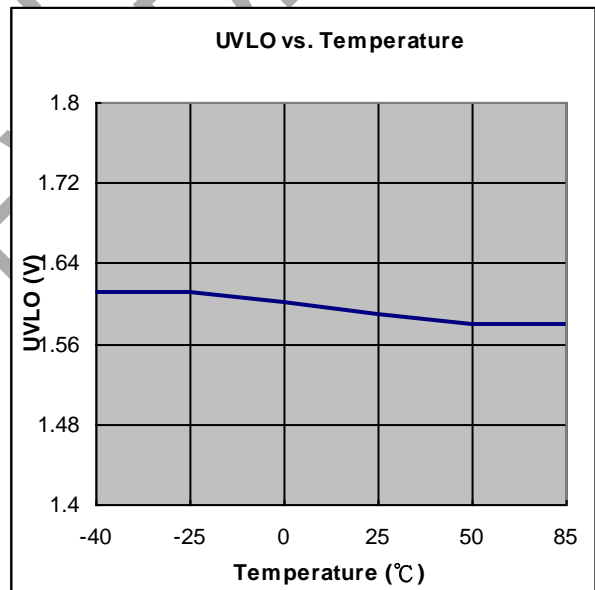

Figure 8

Typical Operating Characteristics (Continued)

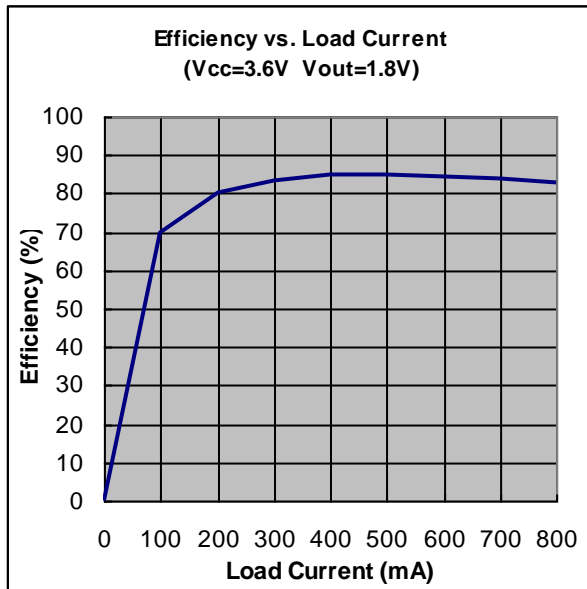

Figure 9

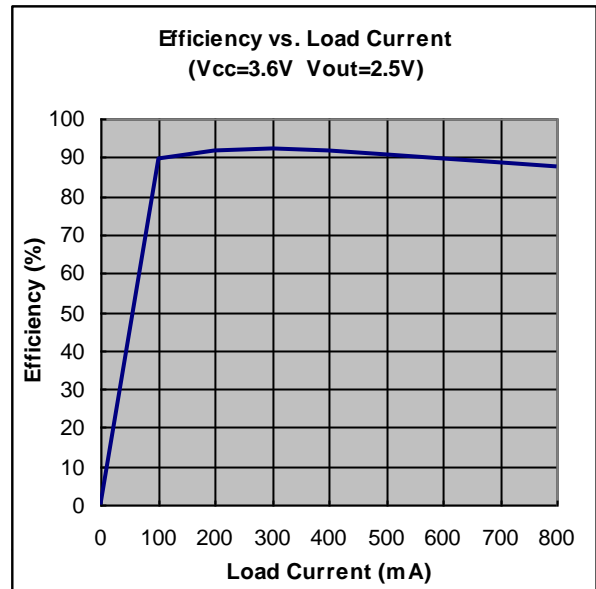

Figure 10

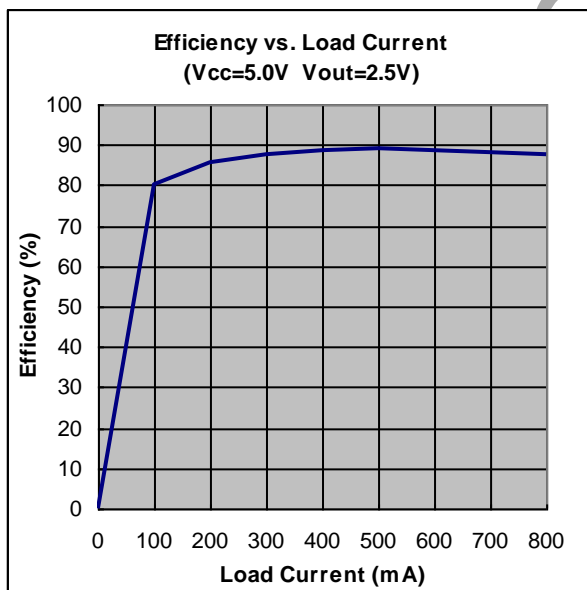

Figure 11

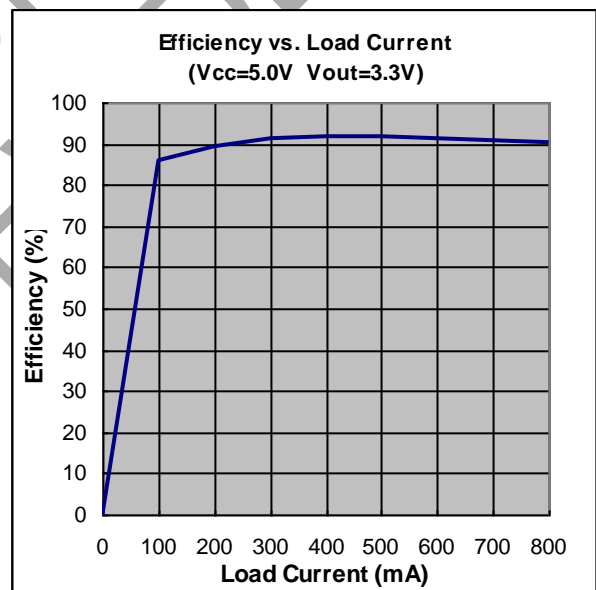

Figure 12

Typical Operating Characteristics (Continued)

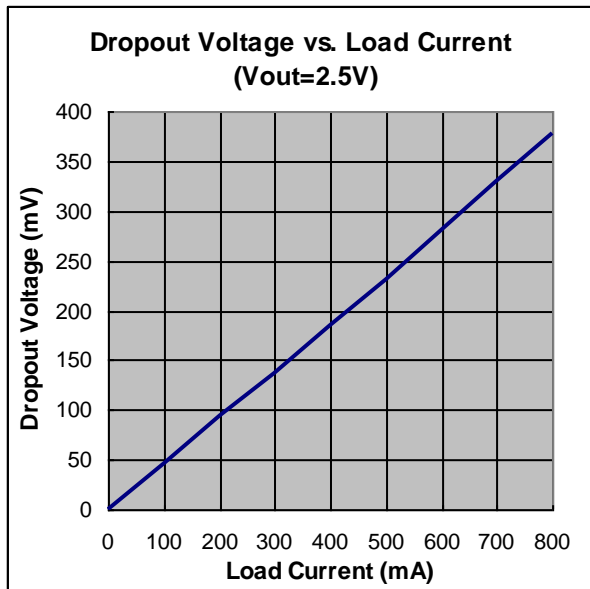

Figure 13

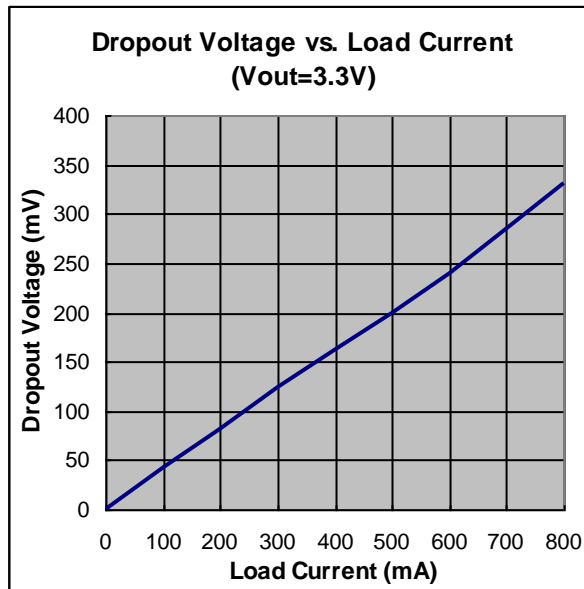

Figure 14

Output Ripple

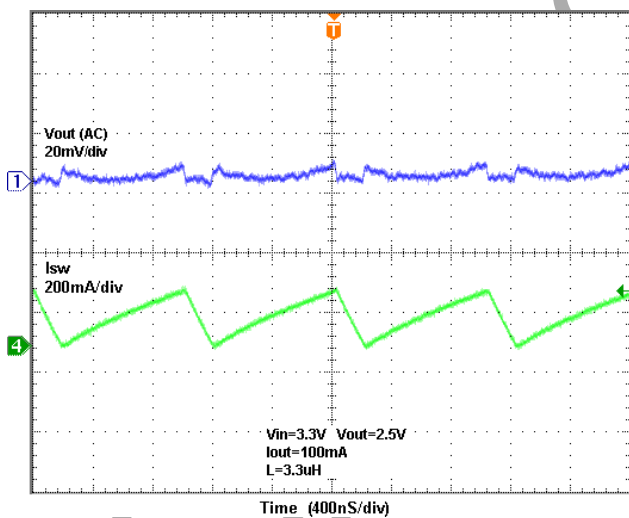

Figure 15

Output Ripple

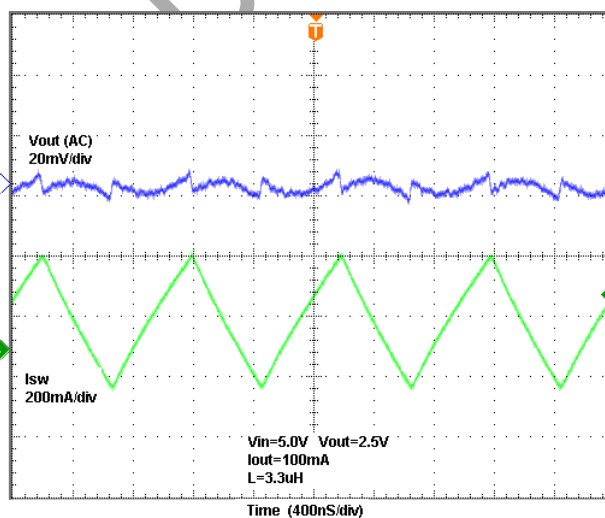

Figure 16

Typical Operating Characteristics (Continued)

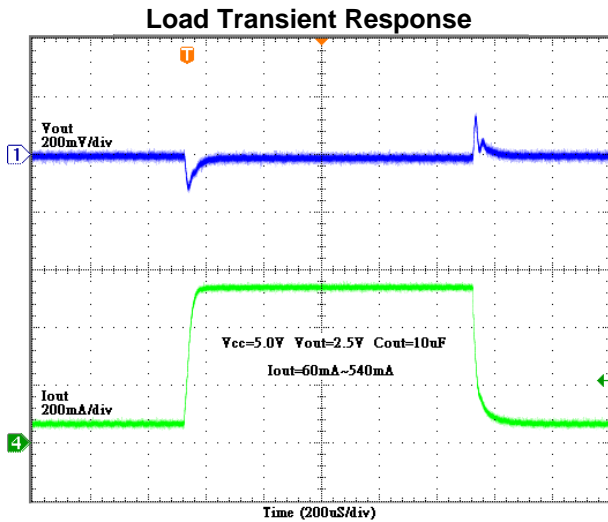

Figure 17

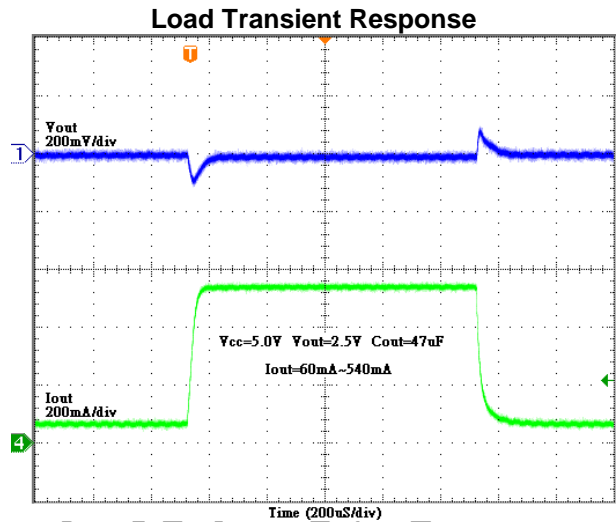

Figure 18

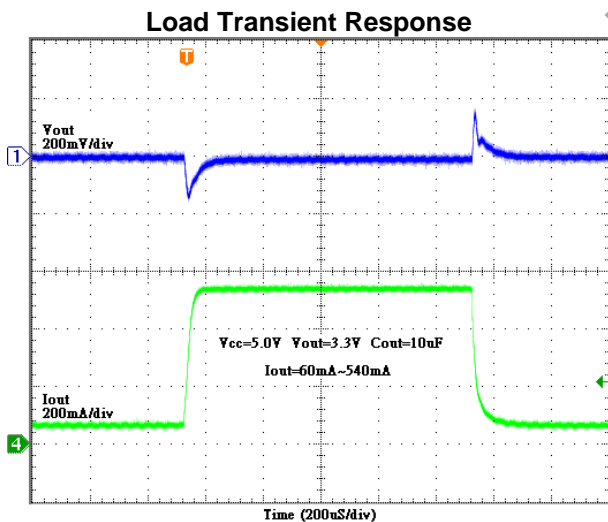

Figure 19

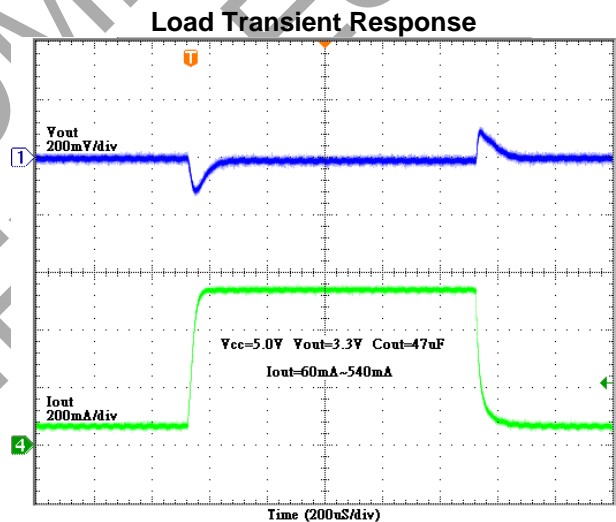

Figure 20

Application Information

■ **Enable (EN)**

When EN is on logic low, the AP6015 goes into shutdown mode. In shutdown, all other functions are turned off. The supply current is reduced to 1uA (Typ.).

■ **Soft Start**

As the enable pin goes high, the soft-start function generates an internal voltage ramp. This causes the start-up current to slowly raise preventing output voltage overshoot and high inrush currents. The soft-start duration is typical 1mSec.

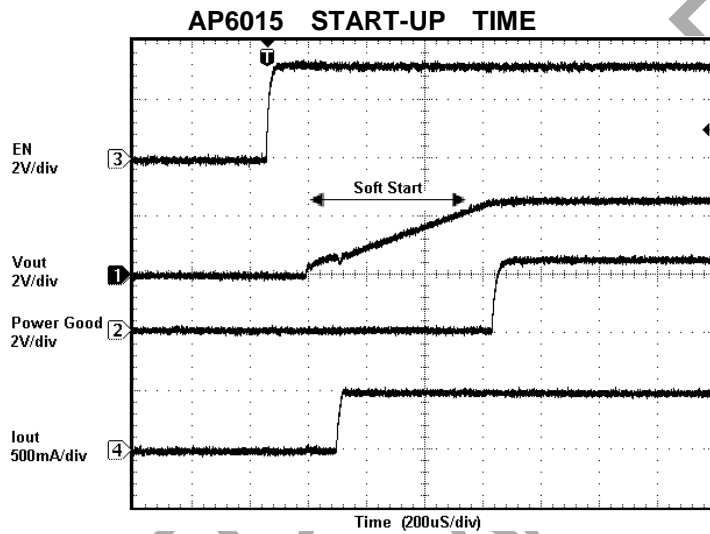

■ **Under Voltage Lock Out (UVLO)**

The UVLO prevents the converter from turning on when the voltage on V_{CC} is less than typically 1.6V.

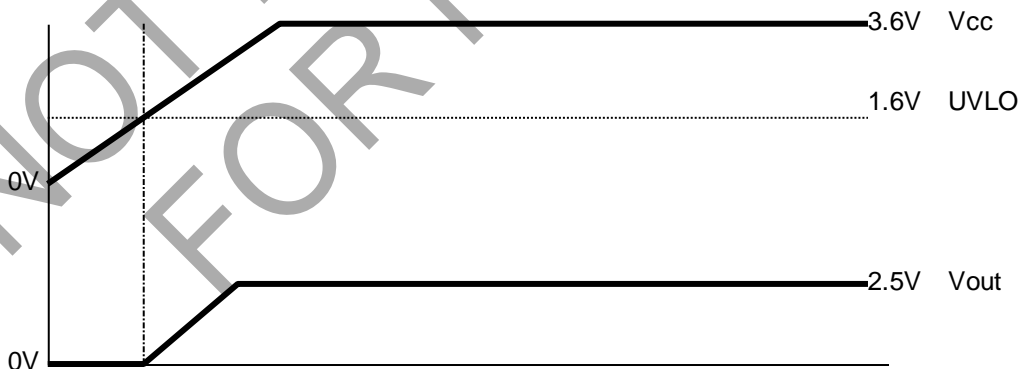

Application Information (Continued)

■ **Power Good (PG)**

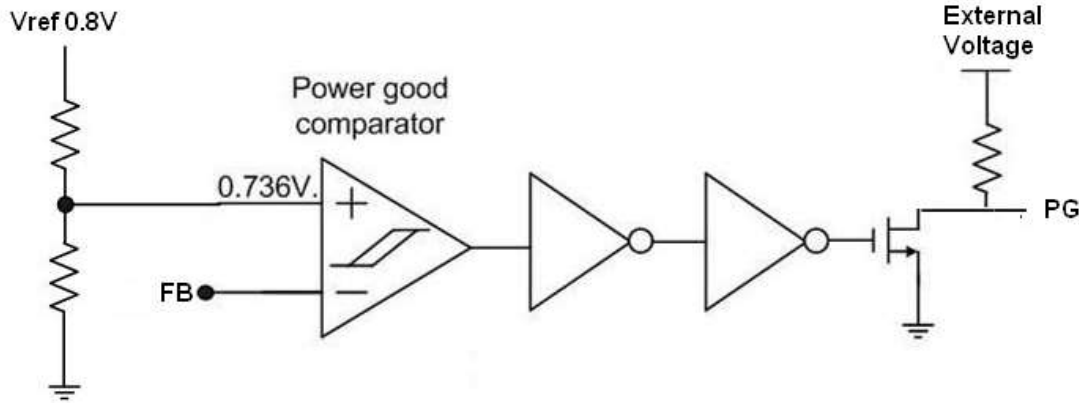

The PG comparator has an open drain output capable of sinking typically 10mA. The PG is only active when the AP6015 is enable (EN=high). When the AP6015 is disable (EN=low), the PG pin is high impedance. If the PG pin is connected to the output of the AP6015 with a pull-up resistor, no initial spike occurs and precautions have to be taken during start-up. The PG pin becomes active high when the output voltage exceeds typically 92% of its nominal value. Leave the PG pin unconnected when not used.

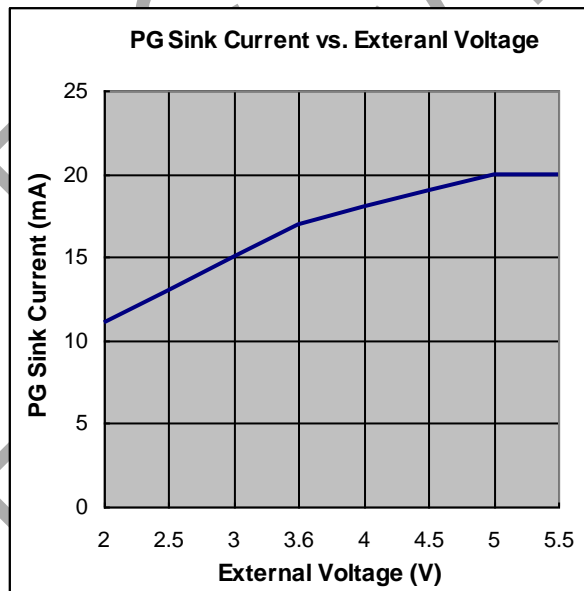

Application Information (Continued)

■ **Inductor Selection**

In order to avoid saturation of the inductor, the inductor should be rated at least for the maximum output current plus the inductor ripple current which is calculated as:

$$\Delta I_L = V_O \times \frac{1 - \left(\frac{V_O}{V_{CC}}\right)}{L \times f} \quad I_{L(MAX)} = I_{O(MAX)} + \frac{\Delta I_L}{2}$$

Where:

f= Switching frequency (1MHz typical)

L = Inductor value

ΔI_L = Peak-to-peak inductor ripple current

$I_L(max)$ = Maximum inductor current

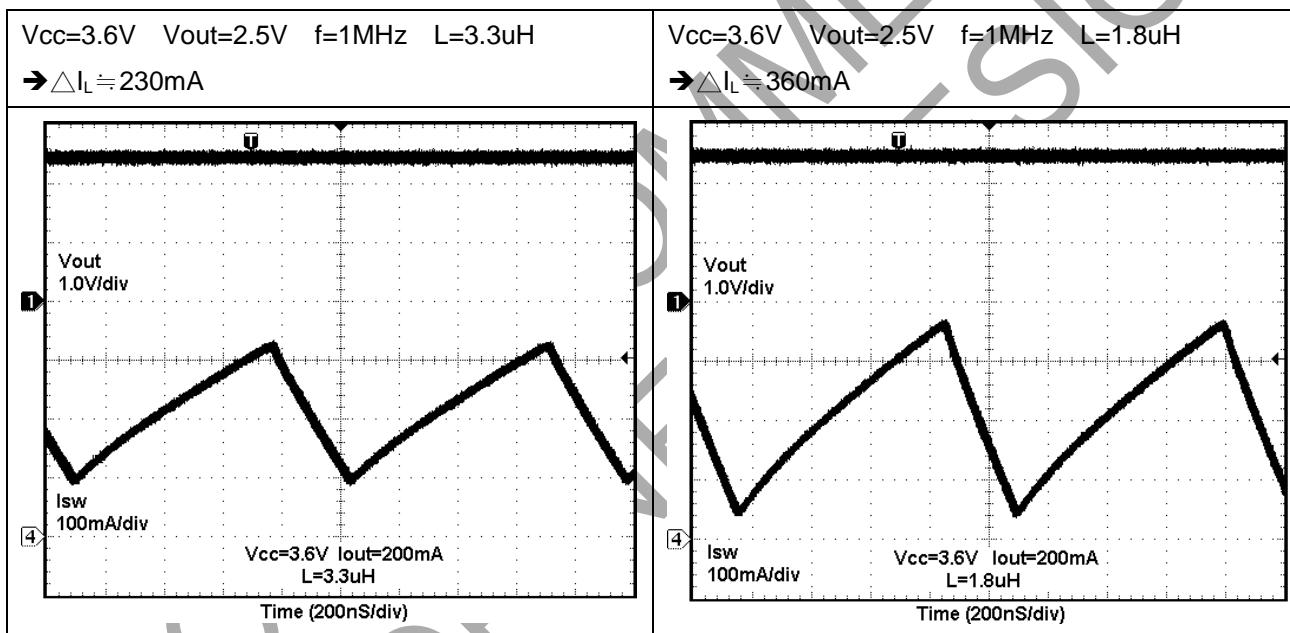

Application Information (Continued)

■ **Input Capacitor Selection**

Though there is no special requirement for the ESR (Equivalent Series Resistance) of the input capacitor, due attention should be paid to the tolerance and temperature coefficient of the capacitor used. A 10uF or larger capacitance is required between the PVCC and the GND pins. The input capacitor should be placed as close as possible to the PVCC pin in order to achieve good overall system performance.

■ **Output Capacitor Selection**

Ripple at the voltage output pin is caused by the charge-and-discharge of the output capacitor. For the best performance, a low ESR output capacitor should be used. The equation below demonstrates how the size of the ripple can be calculated.

$$\Delta V_o = V_o \times \frac{1 - \left(\frac{V_o}{V_{cc}}\right)}{L \times f} \times \left(\frac{1}{8 \times C_o \times f} + ESR\right) = \Delta I_L \times \left(\frac{1}{8 \times C_o \times f} + ESR\right)$$

Where:

ΔV_o = Output voltage ripple

L = Inductor value

f = Switching frequency (1MHz typical)

ΔI_L = Peak-to-peak inductor ripple current

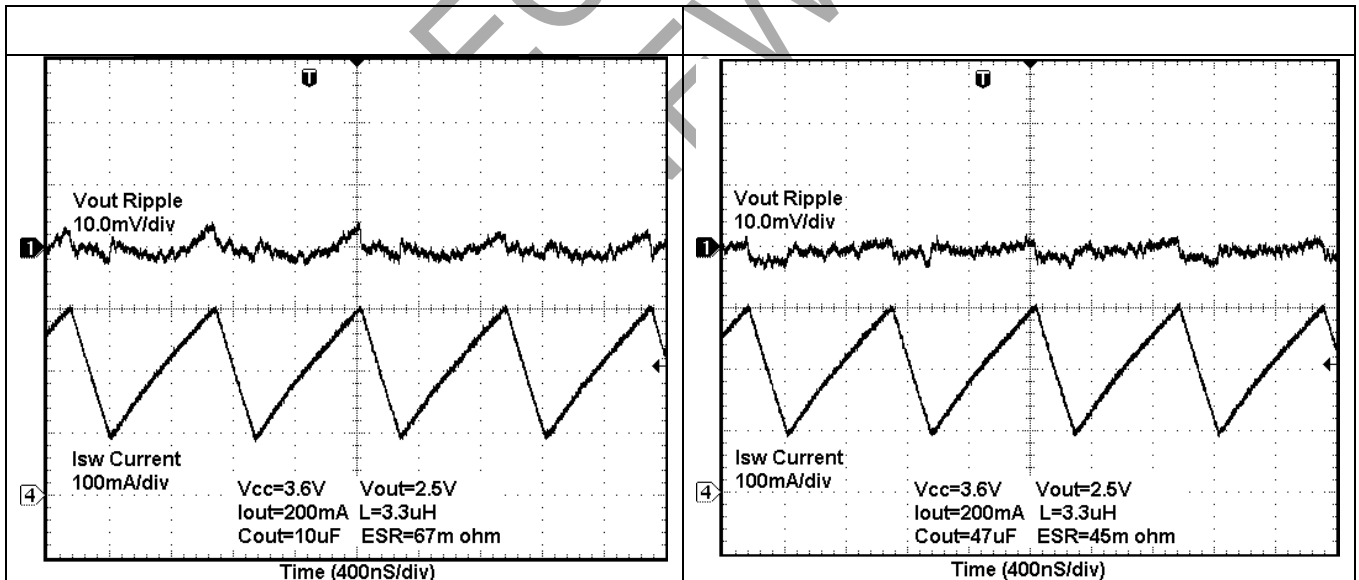

Application Information (Continued)

■ Layout Considerations

A good board layout practice can significantly improve the stability of the application circuit and reduce the system noise. The feedback path must be as short as possible. The input capacitor and bypass capacitor must be placed close to the PVCC and the VCC pins for optimal performance. It is recommended that the ground planes for System Ground / Power Ground / Analog Ground are isolated from each others, while they should all be joined together at a common point. An example drawing of a circuit with good ground noise performance is shown below.

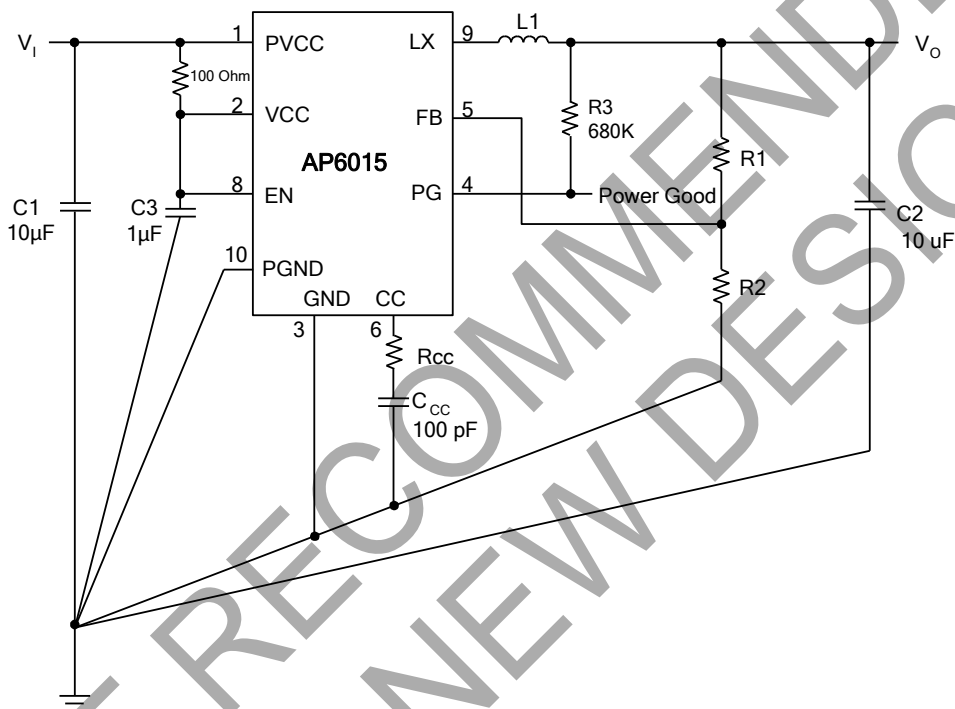

The external inductor must be placed as close as possible to the switching node, i.e. the LX pin. The copper traces on the pcb, where high peak switching current may flow through, should be kept 'wide' and 'short'. This results in low inductance and capacitance in the current path, hence ground shift problem is avoided and system stability stay within bound.

Marking Information

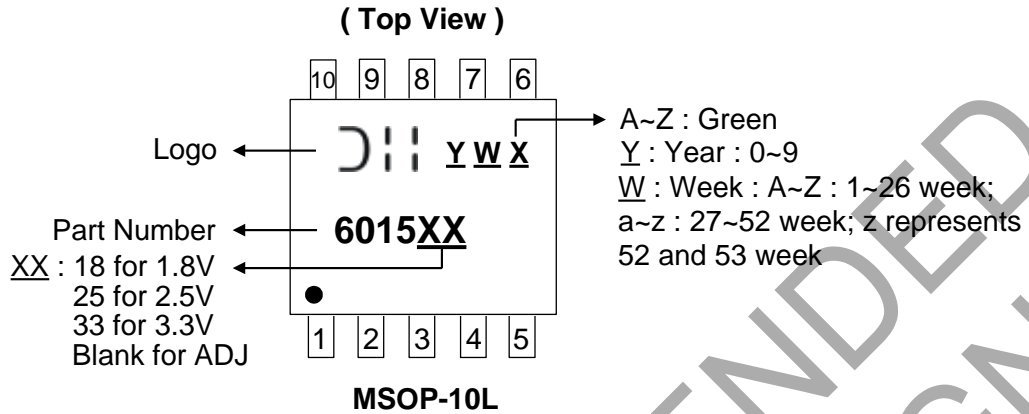

Package Information (All Dimensions in mm)

(1) Package type: MSOP-10L

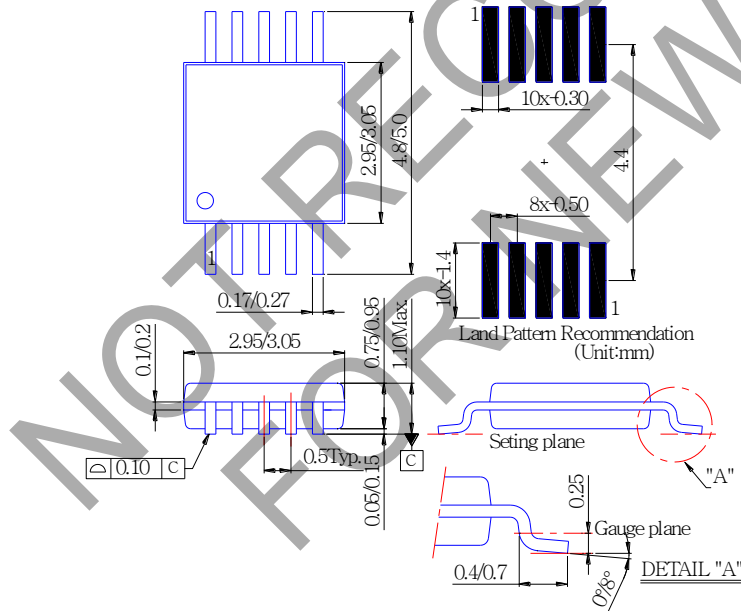

IMPORTANT NOTICE

DIODES INCORPORATED MAKES NO WARRANTY OF ANY KIND, EXPRESS OR IMPLIED, WITH REGARDS TO THIS DOCUMENT, INCLUDING, BUT NOT LIMITED TO, THE IMPLIED WARRANTIES OF MERCHANTABILITY AND FITNESS FOR A PARTICULAR PURPOSE (AND THEIR EQUIVALENTS UNDER THE LAWS OF ANY JURISDICTION).

Diodes Incorporated and its subsidiaries reserve the right to make modifications, enhancements, improvements, corrections or other changes without further notice to this document and any product described herein. Diodes Incorporated does not assume any liability arising out of the application or use of this document or any product described herein; neither does Diodes Incorporated convey any license under its patent or trademark rights, nor the rights of others. Any Customer or user of this document or products described herein in such applications shall assume all risks of such use and will agree to hold Diodes Incorporated and all the companies whose products are represented on Diodes Incorporated website, harmless against all damages.

Diodes Incorporated does not warrant or accept any liability whatsoever in respect of any products purchased through unauthorized sales channel.

Should Customers purchase or use Diodes Incorporated products for any unintended or unauthorized application, Customers shall indemnify and hold Diodes Incorporated and its representatives harmless against all claims, damages, expenses, and attorney fees arising out of, directly or indirectly, any claim of personal injury or death associated with such unintended or unauthorized application.

Products described herein may be covered by one or more United States, international or foreign patents pending. Product names and markings noted herein may also be covered by one or more United States, international or foreign trademarks.

This document is written in English but may be translated into multiple languages for reference. Only the English version of this document is the final and determinative format released by Diodes Incorporated.

LIFE SUPPORT

Diodes Incorporated products are specifically not authorized for use as critical components in life support devices or systems without the express written approval of the Chief Executive Officer of Diodes Incorporated. As used herein:

A. Life support devices or systems are devices or systems which:

1. are intended to implant into the body, or

2. support or sustain life and whose failure to perform when properly used in accordance with instructions for use provided in the labeling can be reasonably expected to result in significant injury to the user.

B. A critical component is any component in a life support device or system whose failure to perform can be reasonably expected to cause the

failure of the life support device or to affect its safety or effectiveness.

Customers represent that they have all necessary expertise in the safety and regulatory ramifications of their life support devices or systems, and acknowledge and agree that they are solely responsible for all legal, regulatory and safety-related requirements concerning their products and any use of Diodes Incorporated products in such safety-critical, life support devices or systems, notwithstanding any devices- or systems-related information or support that may be provided by Diodes Incorporated. Further, Customers must fully indemnify Diodes Incorporated and its representatives against any damages arising out of the use of Diodes Incorporated products in such safety-critical, life support devices or systems.

Copyright © 2018, Diodes Incorporated

www.diodes.com

NOT RECOMMENDED
FOR NEW DESIGN

Looking for pricing, stock, or lifecycle information?

Click below to explore more details on WIN SOURCE:

- ⊖ [View AP6015-18M10G-13 on WIN SOURCE](#)
- ⊖ [Diodes Incorporated Information](#)

Optimize Your Supply Chain with WIN SOURCE Solutions

- ✓ Global Sourcing Solution
- ✓ Obsolete Management
- ✓ Cost Control Management
- ✓ Shortage Management
- ✓ Alternative Solution
- ✓ Excess Inventory Management