



THE DATASHEET OF SPF3006



Dropper Type System Regulator ICs [Surface-mount 2-output] **SPF3006**

Features

- Dual input and dual output (ch1: 5V/0.4A, ch2: 5V/0.2A)
- Power on reset function
- Watchdog timer
- Built-in drooping type overcurrent and thermal protection circuits (ch1)

Absolute Maximum Ratings

(T_a=25°C)

Parameter	Symbol	Ratings	Unit	Remarks
DC input voltage	V _{IN1}	-13 to 35	V	Reverse connection 1 min max.
	V _{IN2}			
Vo1, Vo2 output control terminal voltage	EN	-0.3 to 35	V	
Vo2 output control terminal voltage	VC	-0.3 to 35	V	
Output current	CH1	I _{o1}	0.4	A
	CH2	I _{o2}	0.2	A
TC terminal input voltage	TC	-0.3 to 7	V	
CK terminal input voltage	CK			
W/D/C terminal input voltage	W/D/C			
Reset terminal output voltage	RESET			
Power dissipation	P _{D1}	18.6	W	With an infinite heatsink mounted. *1
	P _{D2}	2.97		
Junction temperature	T _J	-40 to 150	°C	
Operating temperature	T _{op}	-40 to 105	°C	
Storage temperature	T _{stg}	-40 to 150	°C	
Thermal resistance (junction to case)	θ _{J-C}	6.7	°C/W	With an infinite heatsink mounted.
Thermal resistance (junction to ambient air)	θ _{J-A}	42	°C/W	*1

Notes: *1: With glass epoxy + copper foil board (size 5.0 × 7.4cm; t: glass epoxy = 1.6mm / copper foil = 18μm)

Electrical Characteristics

Parameter	Symbol	Ratings			Unit	Conditions		
		min	typ	max				
Input voltage	V _{IN1, 2}	Vo1+V _{DIF1}		35	V	*2, 3		
Output voltage	CH1	Vo1	4.85	5.00	5.15	V	V _{IN1} = 6 to 18V, I _o = 0 to 0.3A	
	CH2	Vo2	4.85	5.00	5.15	V	V _{IN2} = 6 to 18V, I _o = 0 to 0.3A	
Dropout voltage	CH1	V _{DIF1}			0.5	V		
	CH2	V _{DIF2}			0.5	V		
Ripple rejection	CH1	R _{REJ1}		54		db	f = 100 to 120Hz	
	CH2	R _{REJ2}		54				
Quiescent circuit current	I _q		10	50		μA	V _{IN1} = 16V, V _{EN} = 0V	
			50	250				V _{IN1} = 35V, V _{EN} = 0V
			5	10				
GND current	I _{GND}		70	100		mA	I _{o1} = I _{o2} = 0.2A	
Overcurrent protection starting current	CH1	I _{s11}	0.402		1.8	A	Vo1 = 4.5V	
	CH2	I _{s21}	0.201		0.8	A	Vo2 = 4.5V	
Residual current at a short	CH1	I _{s21}	0.402		1.8	A	Vo1 = 0V	
	CH2	I _{s22}	0.201		0.8	A	Vo2 = 0V	
EN output control voltage	V _{ENth}		0.9		3.5	V		
EN output control current	ON	I _{ENH}			50	μA	EN = 5V	
	OFF	I _{ENL}	-1.0		1.0	μA	EN = 0V	
Reset terminal LOW voltage	V _{rSL}				0.5	V	I _{sink} = 250μA (Pull-up resistance 20kΩ typ)	
Reset terminal HI voltage	V _{rSH}	Vo1 - 0.8V				V	I _{source} = 15μA *4	
Reset detect voltage	CH	Vo1thH			Vo1 • 0.97	V	V _{rS} > 4.5V	
		Vo1thL	4.05			V	V _{rS} < 0.8V	
Power on reset delay time	t _{dly}	1.18 • R _{tc} • C _{tc}	1.26 • R _{tc} • C _{tc}	1.35 • R _{tc} • C _{tc}		S	Min. set time: 6mS	
W/D time	t _{wd}	0.93 • R _{tc} • C _{tc}	1.03 • R _{tc} • C _{tc}	1.13 • R _{tc} • C _{tc}		S	Min. set time: 4mS	
W/D pulse time	t _{wdp}	0.07 • R _{tc} • C _{tc}	0.13 • R _{tc} • C _{tc}	0.19 • R _{tc} • C _{tc}		S	Min. set time: 400μS	
CK terminal control voltage	V _{ckth}		1.0		3.0	V	Min. clock pulse time: 5μs (Duty 50%)	
CK terminal control current	ON	I _{ckH}			200	μA	V _{ck} = 5V	
	OFF	I _{ckL}	-1.0		1.0	μA	V _{ck} = 0V	
Vc output control voltage	V _{cth}		1.0		3.5	V		
Vc output control current	I _{ch}				300	μA	V _c = 5V	
	I _{cl}		-1.0		1.0	μA	V _c = 0V	
W/D/C terminal control voltage	V _{w/d/cth}		1.0		3.0	V		
W/D/C terminal control current	ON	I _{w/d/ch}			200	μA	V _{w/d/c} = 5V	
	OFF	I _{w/d/cl}	-1.0		1.0	μA	V _{w/d/c} = 0V	

Notes:

*2: Refer to Dropout Voltage.

*3: Since P_{D(max)} = (V_{IN} - V_{O1}) • I_{o1} + (V_{IN2} - V_{O2}) • I_{o2} + (V_{IN} • I_q) = 22W, V_{IN(max)}, I_{o1(max)} and I_{o2(max)} may be limited depending on operating conditions.

*4: The RESET terminal is pulled up in the IC; may be directly connected to logic circuits.

*6: The thermal protection function is built in V_{O1} (CH1 side) only. The design thermal protection starting temperature is 151°C (min.) and 165°C (typ). These values represent the design warranty.

External Dimensions (unit: mm)

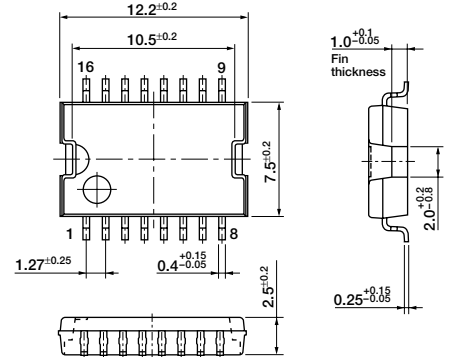

Standard Connection Diagram

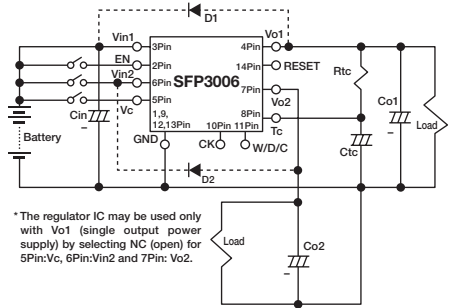

* The regulator IC may be used only with Vo1 (single output power supply) by selecting NC (open) for 5Pin:Vc, 6Pin:Vin2 and 7Pin:Vo2.

Cin: Capacitor (39μF) for oscillation prevention
Co1: Output capacitor (39μF)
Co2: Output capacitor (39μF)

Tantalum capacitors are recommended particularly for low temperatures (tantalum capacitors of about 0.47μF in parallel).
D1, D2: Protection diodes.
Required for protection against reverse biasing between input and output (Recommended diode: SANKEN EU2Z).

Circuit Block Diagram

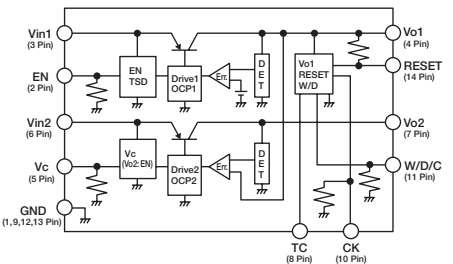

Timing Chart

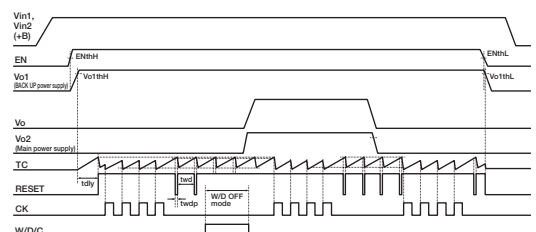

Electrical Characteristics

■ Rise Characteristics of Output Voltage (V_{O1})

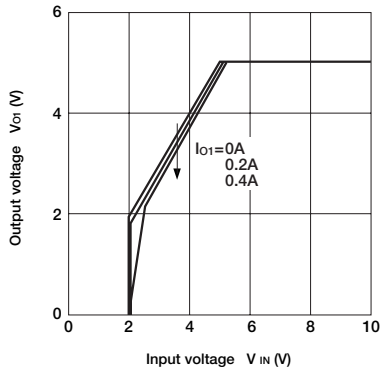

■ Rise Characteristics of Output Voltage (V_{O2})

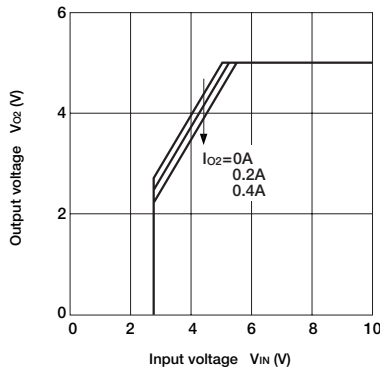

■ Line Regulation (V_{O1})

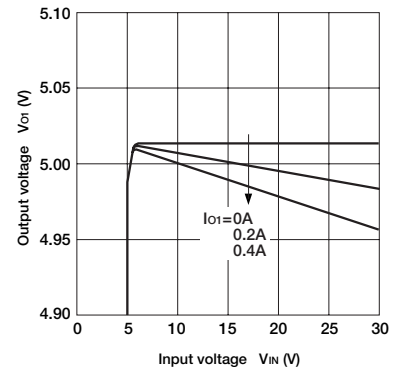

■ Line Regulation (V_{O2})

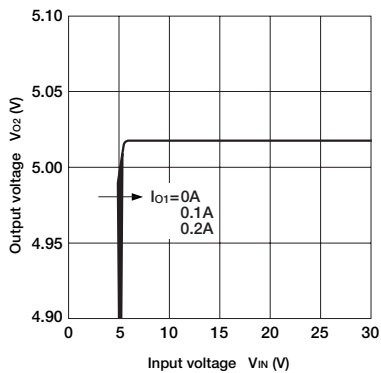

■ Load Regulation (V_{O1})

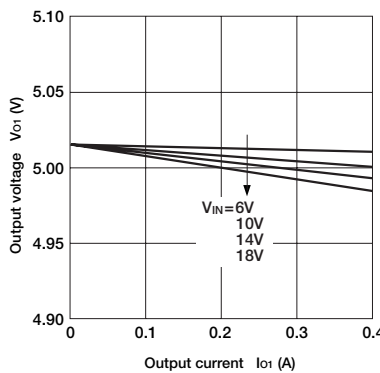

■ Load Regulation (V_{O2})

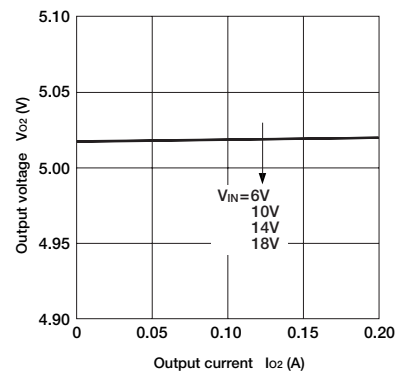

■ Dropout Voltage (V_{O1})

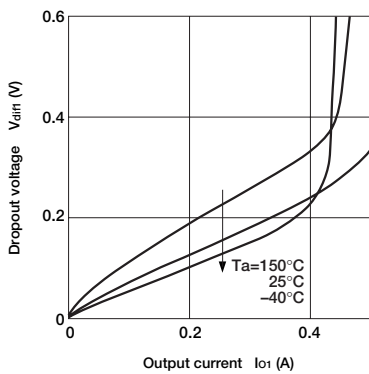

■ Dropout Voltage (V_{O2})

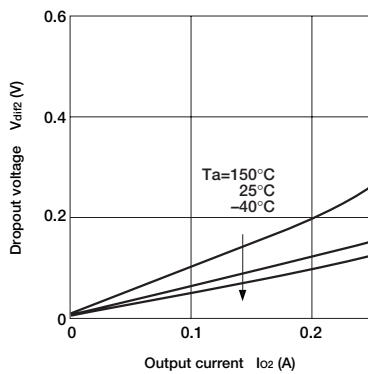

■ Overcurrent Protection Characteristics (V_{O1})

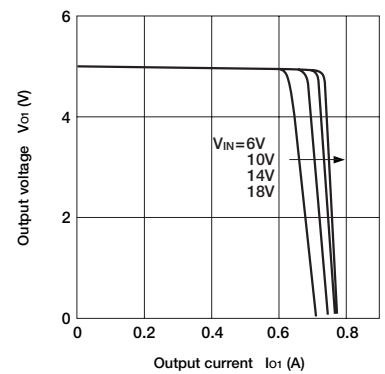

■ Overcurrent Protection Characteristics (V_{O2})

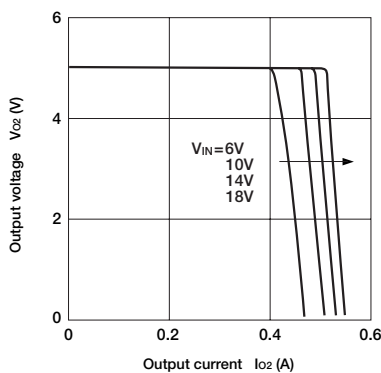

■ Thermal Protection Characteristics

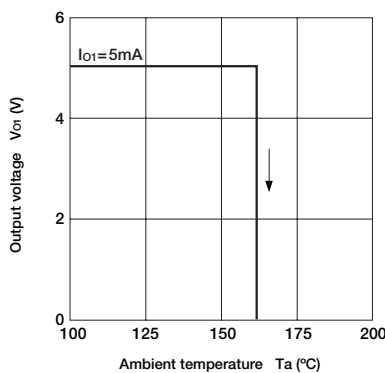

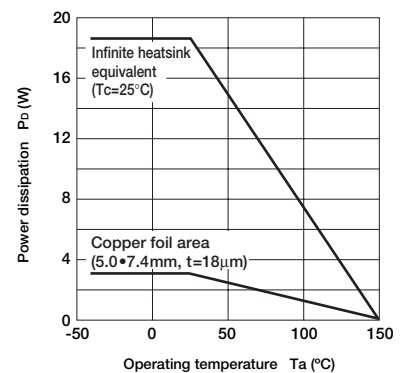

■ T_a—P_D Characteristics









Looking for pricing, stock, or lifecycle information?

Click below to explore more details on WIN SOURCE:

-  [View SPF3006 on WIN SOURCE](#)
-  [Sanken Information](#)

Optimize Your Supply Chain with WIN SOURCE Solutions

-  Global Sourcing Solution
-  Obsolete Management
-  Cost Control Management
-  Shortage Management
-  Alternative Solution
-  Excess Inventory Management