



**THE DATASHEET OF
AP7115-15SEG-7**



Description

The AP7115 is a 150mA, fixed output voltage, low dropout linear regulator. The device includes pass element, error amplifier, band gap reference, current-limit and thermal shutdown circuit. The characteristics of low dropout voltage and low quiescent current make it suitable for use in battery powered devices. The typical quiescent current is approximately 50µA. Several fixed output voltages are available from 1.0V to 3.5V. Additional protection is provided with built-in current-limit and thermal-shutdown functions.

Features

- Wide Input Voltage Range from 2.5V to 5.5V
- 200mV Low Dropout Voltage at 150mA Output Current
- Guaranteed 150mA Output Current
- Low Quiescent Current 50µA
- Output Voltage from 1.0V to 3.5V
- ±2% Output Voltage Accuracy
- Low Temperature Drift at Output Voltage
- High PSRR
- Fast Transient Response
- Current Limit Protection
- Short Circuit Protection
- Thermal Shutdown Protection
- SOT25 and SOT353: Available in "Green" Molding Compound (No Br, Sb)
- **Totally Lead-Free & Fully RoHS Compliant (Notes 1 & 2)**
- **Halogen and Antimony Free. "Green" Device (Note 3)**

- Notes:
1. No purposely added lead. Fully EU Directive 2002/95/EC (RoHS) & 2011/65/EU (RoHS 2) compliant.
 2. See http://www.diodes.com/quality/lead_free.html for more information about Diodes Incorporated's definitions of Halogen- and Antimony-free, "Green" and Lead-free.
 3. Halogen- and Antimony-free "Green" products are defined as those which contain <900ppm bromine, <900ppm chlorine (<1500ppm total Br + Cl) and <1000ppm antimony compounds.

Typical Applications Circuit

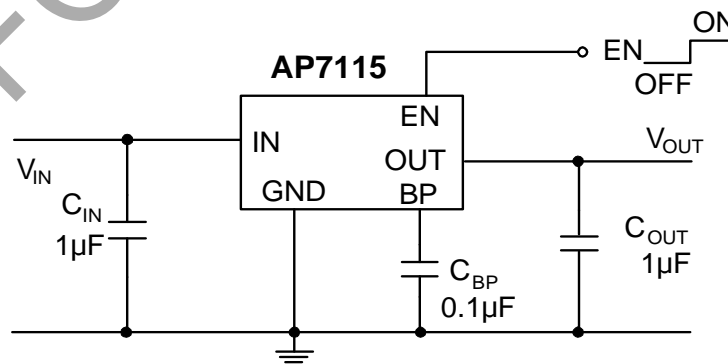

Pin Assignments

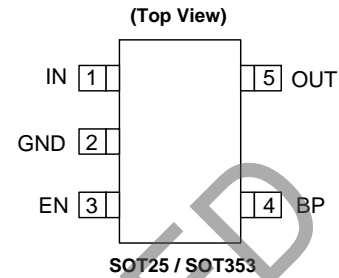

Applications

- Wireless Communication
- GSM/GPRS Cellular Phones
- Handheld Mobile Devices
- Battery Powered Devices
- CD-ROM, DVD, and LAN Cards
- PC and Notebook Peripherals

Pin Descriptions

Pin Number	Pin Name	Description
1	IN	Voltage Input
2	GND	Ground
3	EN	Chip Enable Control
4	BP	Band-Gap Bypass
5	OUT	Voltage Output

Functional Block Diagram

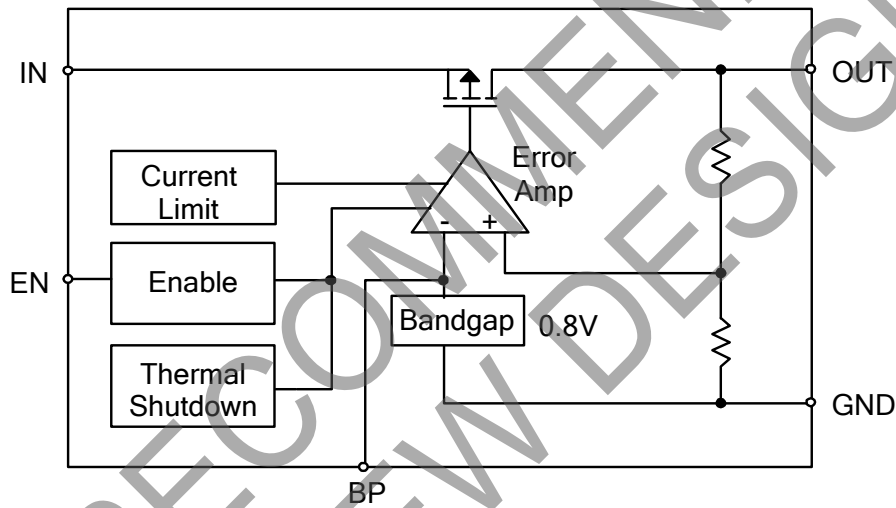

Absolute Maximum Ratings (@T_A = +25°C, unless otherwise specified.)

Symbol	Parameter	Rating	Unit
ESD HBM	Human Body Model ESD Protection	3.5	kV
ESD MM	Machine Model ESD Protection	400	V
V _{IN}	Input Voltage	-0.3 to 5.5	V
V _{EN}	EN Pin Voltage	-0.3 to 5.5	V
V _{OUT}	Output Voltage	-0.3 to V _{IN} +0.3	V
V _{BP}	Band Gap Bypass Pin Voltage	-0.3 to 5.5	V
P _D	Power Dissipation	500	mW
T _J	Operating Junction Temperature Range	-40 to +125	°C
T _{ST}	Storage Temperature Range	-65 to +150	°C

Recommended Operating Conditions (@T_A = +25°C, unless otherwise specified.)

Symbol	Parameter	Min	Max	Unit
V _{IN}	Input Voltage	2.5	5.5	V
I _{OUT}	Output Current	—	150	mA
T _A	Operating Ambient Temperature	-40	+85	°C

Electrical Characteristics (@V_{CC} = 3.3V, I_L = 30mA, C_{IN} = 1μF, C_{OUT} = 1μF, T_A = +25°C)

Symbol	Parameter	Conditions	Min	Typ	Max	Unit
System Supply Input						
V _{IN}	Operating Input Voltage	I _L = 0 to 150mA	2.5	—	5.5	V
ΔV _{OUT} /V _{OUT}	Output Voltage Accuracy	V _{IN} = V _{OUT} + 1V where 1mA ≤ I _{OUT} ≤ 50mA	-2	—	2	%
V _{DO}	Dropout Voltage	I _L = 150mA	—	200	300	mV
I _{OUT}	Output Current	V _{IN} - V _{OUT} = 1V	150	—	—	mA
I _Q	Quiescent Current	V _{IN} = V _{OUT} + 1V where I _{OUT} = 0 and V _{EN} = V _{IN}	—	50	80	μA
I _{SHUTDOWN}	Shutdown Current	V _{IN} = V _{OUT} + 1V where I _{OUT} = 0 and V _{EN} = 0	—	0.1	1	μA
PSRR	Power Supply Rejection Ratio	I _{OUT} = 30mA, f = 1kHz	—	70	—	dB
I _{LIMIT}	Current Limit	—	200	250	—	mA
Thermal Management						
T _{SHUTDOWN}	Thermal Shutdown	—	—	+150	—	°C
Reference Voltage						
ΔV _{REF} /ΔT	Tempco of Bandgap Reference	—	—	30	50	ppm/°C
ΔV _{OUT} /ΔT	Tempco of Output Voltage	I _{OUT} = 30mA, -40°C ≤ T _A ≤ +85°C	—	50	100	ppm/°C
Control and Protection						
V _{IH,EN}	—	—	2.0	—	—	V
V _{IL,EN}	—	—	—	—	0.7	V
I _{EN}	EN Pin Leakage Current	V _{EN} = V _{IN} @ V _{IN} = 5.0V and V _{SS} = 0V	—	0.01	0.1	μA
		V _{EN} = V _{SS} @ V _{IN} = 5.0V and V _{SS} = 0V	—	0.01	0.1	μA
Regulation						
ΔV _O /ΔV _{IN}	Line Regulation	V _{OUT} + 0.5V ≤ V _{IN} ≤ 5.5V where V _{OUT} > 2.0V, I _{OUT} = 30mA	—	0.02	0.1	%/V
ΔV _{LOAD}	Load Regulation	1mA ≤ I _L ≤ 150mA where V _{IN} = V _{OUT} + 1V	—	0.003	0.006	%/mA
Noise						
e _n	Output Noise	BW = 10Hz to 100kHz	—	50	—	μV _{rms}
Thermal Resistance						
θ _{JA}	Thermal Resistance Junction-to-Ambient	SOT25 (Note 4)	—	200	—	°C/W
		SOT353 (Note 4)	—	337	—	°C/W
θ _{JC}	Thermal Resistance Junction-to-Case	SOT25 (Note 4)	—	52	—	°C/W
		SOT353 (Note 4)	—	121	—	°C/W

Note: 4. Test condition for SOT25 and SOT353: Device mounted on FR-4 substrate PC board, 2oz copper, with minimum recommended pad layout.

Typical Operating Characteristics

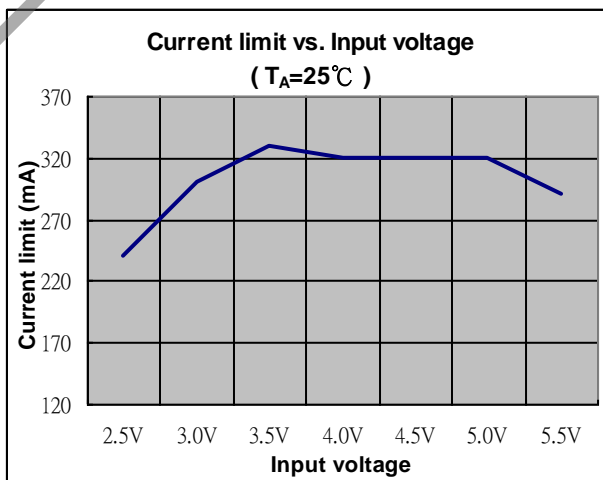
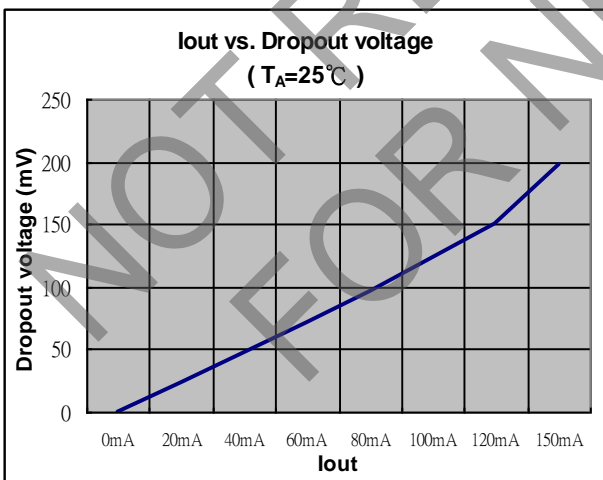
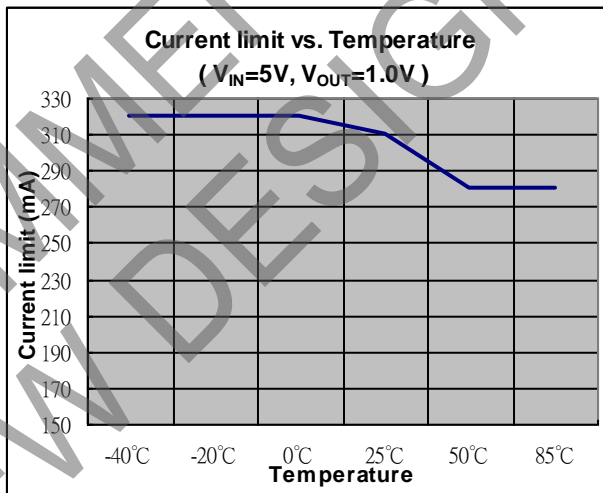
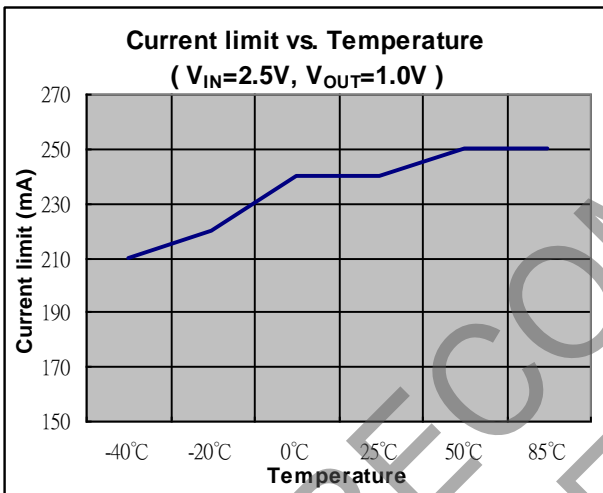
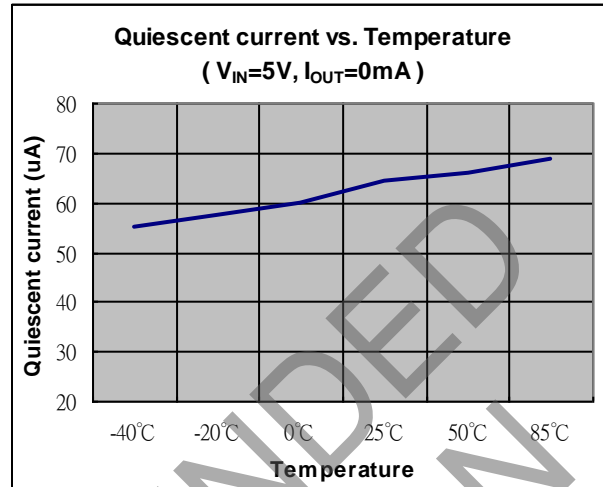
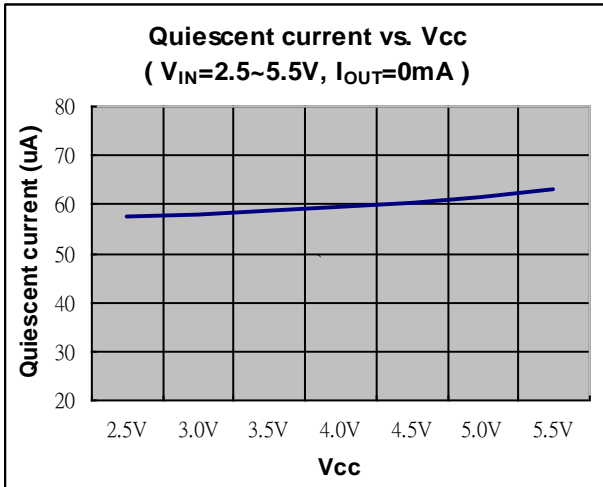

Typical Operating Characteristics (Cont.)

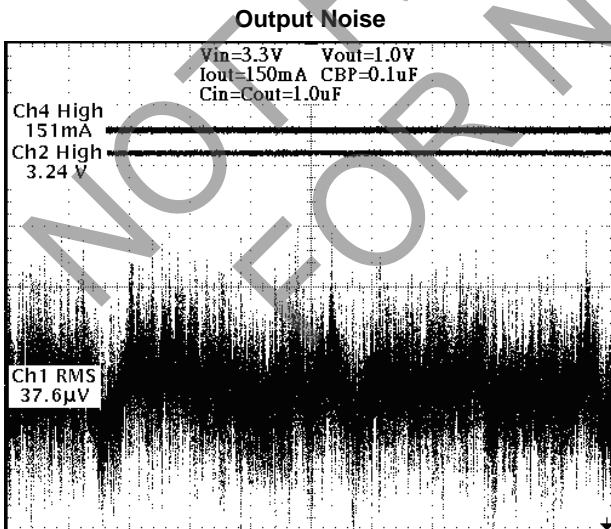
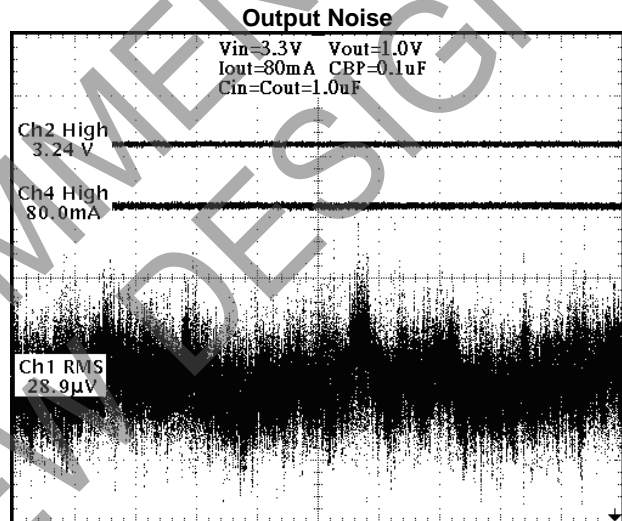
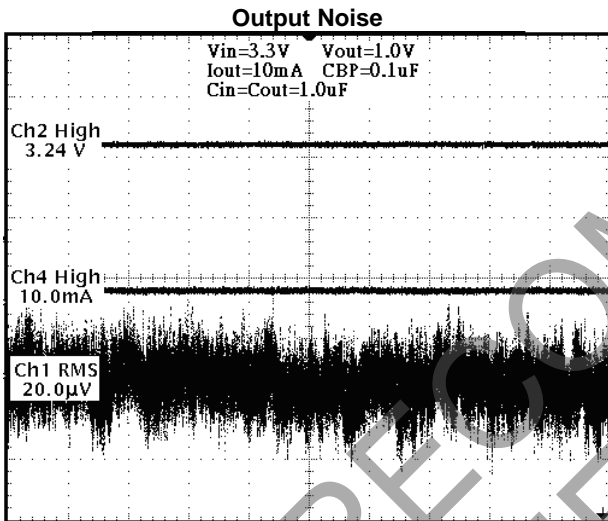
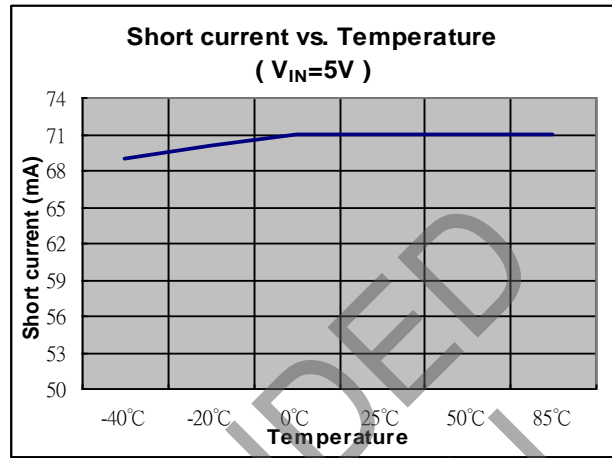
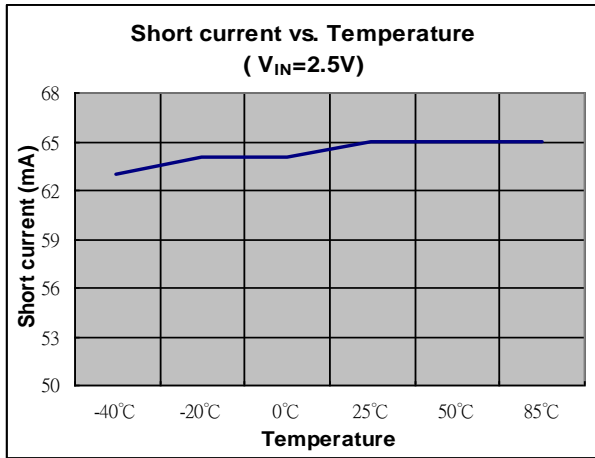

Typical Operating Characteristics (Cont.)

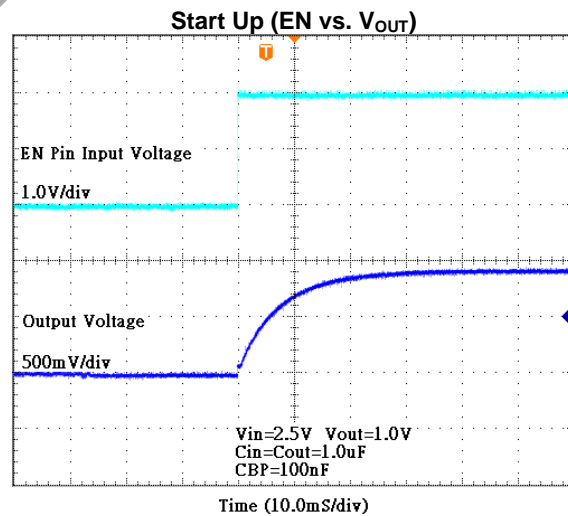
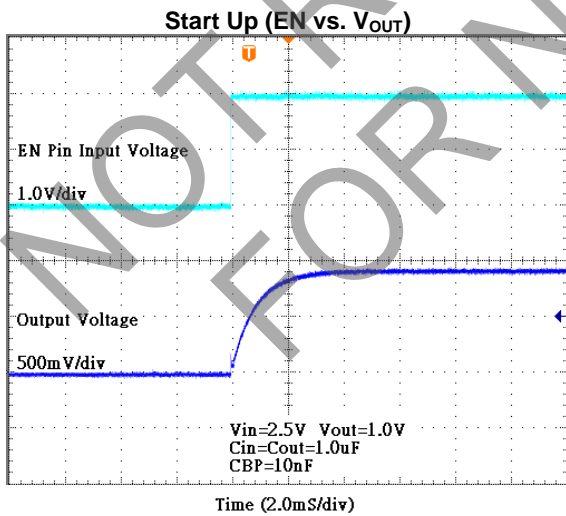
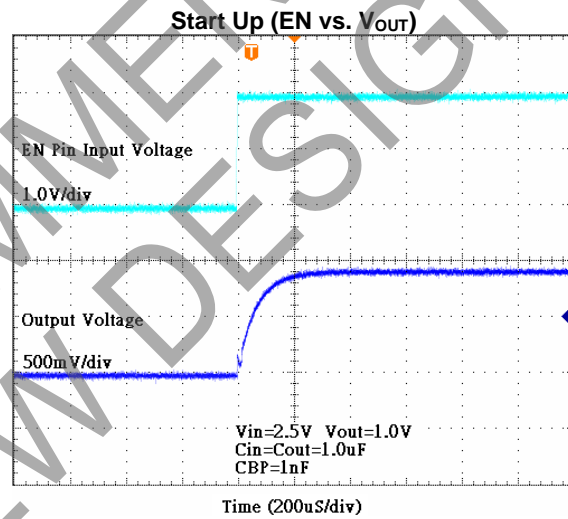
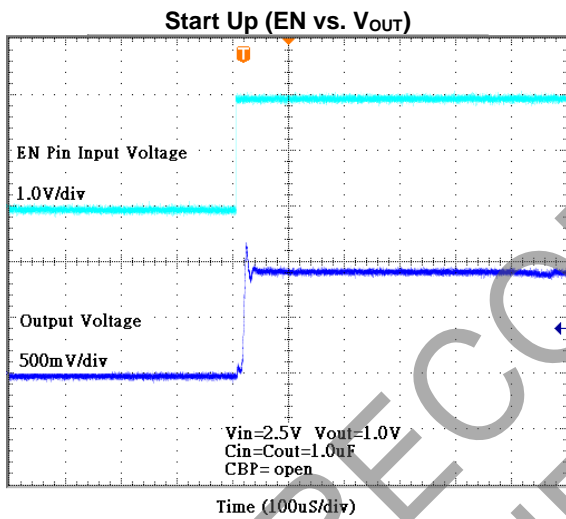
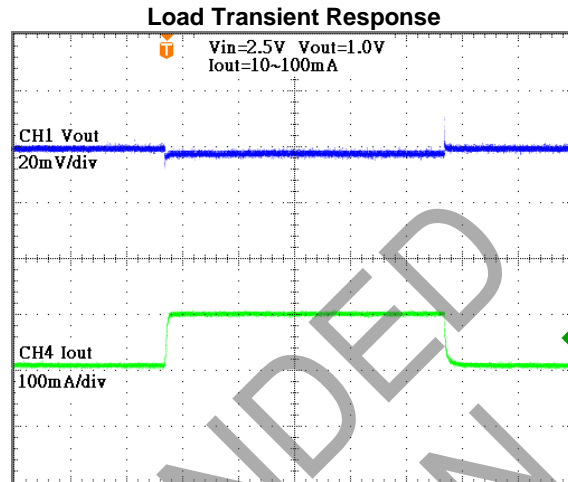
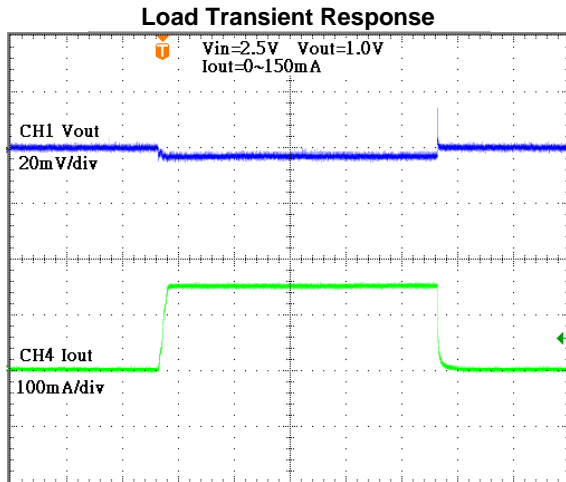

Application Note

Input Capacitor

A 1µF input capacitor is required between the AP7115 input pin and GND.

There are no requirements for the ESR on input capacitor, but tolerance and temperature coefficient must be considered.

Output Capacitor

The AP7115 can work with very small ceramic output capacitors (1µF or greater). Higher capacitance values help to improve transient. The output capacitor's ESR is critical because it from a zero to provide phase lead which is required for loop stability.

Figure below is Cout ESR vs. Load Current.

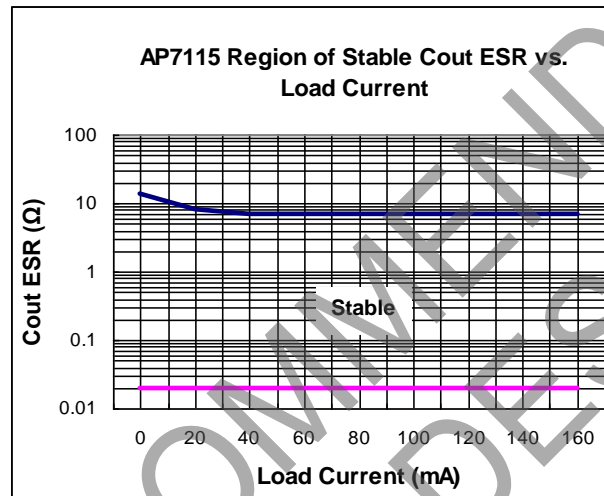

Band-Gap Bypass Capacitor

0.1µF bypass capacitor Between BP pin and GND can reduce output voltage noise.

Shutdown Input Operation

The AP7115 is shutdown by pulling the EN pin low, and turned on by driving the input high. If the shutdown feature is not required, the EN pin should be tied to VIN to keep the regulator on at all time.

Dropout Voltage

$$V_{\text{DROPOUT}} = V_{\text{IN}} - V_{\text{OUT}} = R_{\text{DS(ON)}} \times I_{\text{OUT}}$$

Current Limit

The AP7115 monitors and controls the PMOS' gate voltage, limiting the output current to 250mA (typ.). The output can be shorted to ground for an indefinite period of time without damaging the part.

Application Note (Cont.)

PCB Layout

Optimum performance can only be achieved when the device is mounted on a PC board according to the diagram below:

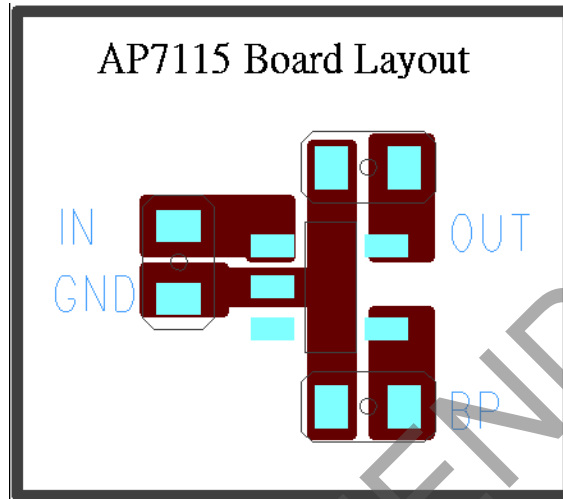

Thermal Considerations

Thermal Shutdown Protection limits power dissipation in AP7115. When the operation junction temperature exceeds +155°C, the Over Temperature Protection circuit starts the thermal shutdown function and turns the pass element off. The pass element turns on again after the junction temperature cools by +30°C. For continuous operation, do not exceed absolute maximum operation junction temperature +125°C. The power dissipation definition in device is:

$$P_D = (V_{IN} - V_{OUT}) \times I_{OUT} + V_{IN} \times I_Q$$

The maximum power dissipation depends on the thermal resistance of IC package, PCB layout, the rate of surroundings airflow and temperature difference between junction to ambient. The maximum power dissipation can be calculated by the following formula:

$$P_{D(MAX)} = (T_{J(MAX)} - T_A) / \theta_{JA}$$

Where $T_{J(MAX)}$ is the maximum operation junction temperature +125°C, T_A is the ambient temperature and the θ_{JA} is the junction to ambient thermal resistance.

Ordering Information

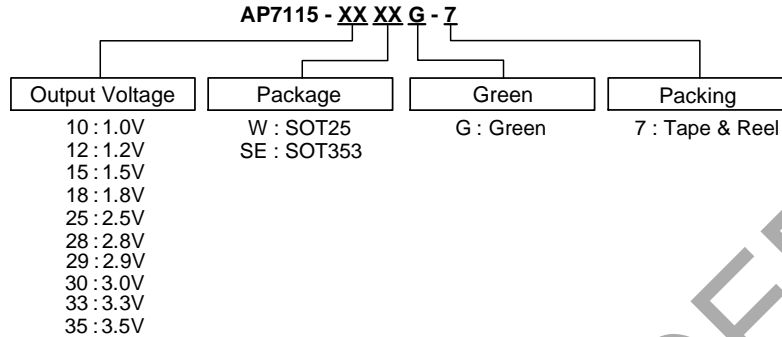

Part Number	Package Code	Packaging (Note 5)	7" Tape and Reel	
			Quantity	Part Number Suffix
AP7115-XXWG-7	W	SOT25	3000/Tape & Reel	-7
AP7115-XXSEG-7	SE	SOT353	3000/Tape & Reel	-7

Notes: 5. Pad layout as shown in Diodes Incorporated's package outline PDFs, which can be found on our website at <http://www.diodes.com/package-outlines.html>.

Marking Information

SOT25/SOT353

(Top View)

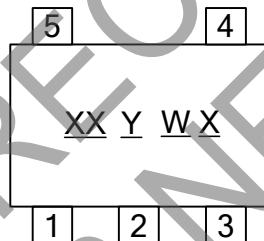

XX : Identification code
 Y : Year 0~9
 W : Week : A~Z : 1~26 week;
 a~z : 27~52 week; z represents
 52 and 53 week
 X : A~Z : Green

Part Number	Identification Code	Part Number	Identification Code
SOT25		SOT353	
AP7115-10WG-7	FO	AP7115-10SEG-7	GO
AP7115-12WG-7	FP	AP7115-12SEG-7	GP
AP7115-15WG-7	FQ	AP7115-15SEG-7	GQ
AP7115-18WG-7	FR	AP7115-18SEG-7	GR
AP7115-25WG-7	FS	AP7115-25SEG-7	GS
AP7115-28WG-7	FT	AP7115-28SEG-7	GT
AP7115-29WG-7	FU	AP7115-29SEG-7	GU
AP7115-30WG-7	FV	AP7115-30SEG-7	GV
AP7115-33WG-7	FW	AP7115-33SEG-7	GW
AP7115-35WG-7	FX	AP7115-35SEG-7	GX

Package Outline Dimensions

Please see <http://www.diodes.com/package-outlines.html> for the latest version.

(1) Package Type: SOT25

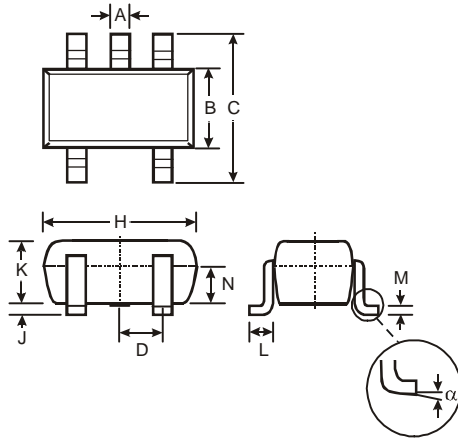

SOT25			
Dim	Min	Max	Typ
A	0.35	0.50	0.38
B	1.50	1.70	1.60
C	2.70	3.00	2.80
D	-	-	0.95
H	2.90	3.10	3.00
J	0.013	0.10	0.05
K	1.00	1.30	1.10
L	0.35	0.55	0.40
M	0.10	0.20	0.15
N	0.70	0.80	0.75
α	0°	8°	-
All Dimensions in mm			

(2) Package Type: SOT353

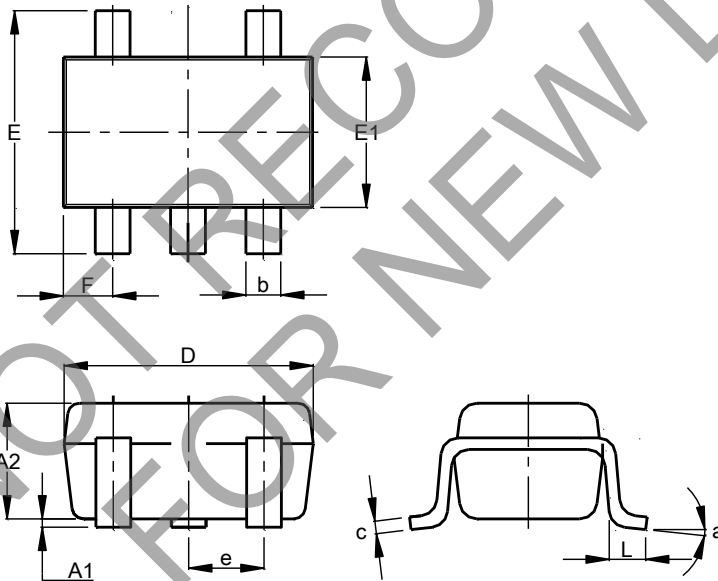

SOT353			
Dim	Min	Max	Typ
A1	0.00	0.10	0.05
A2	0.90	1.00	1.00
b	0.10	0.30	0.25
c	0.10	0.22	0.11
D	1.80	2.20	2.15
E	2.00	2.20	2.10
E1	1.15	1.35	1.30
e	0.650 BSC		
F	0.40	0.45	0.425
L	0.25	0.40	0.30
a	0°	8°	--
All Dimensions in mm			

Suggested Pad Layout

Please see <http://www.diodes.com/package-outlines.html> for the latest version.

(1) Package Type: SOT25

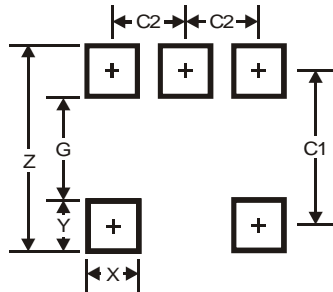

Dimensions	Value
Z	3.20
G	1.60
X	0.55
Y	0.80
C1	2.40
C2	0.95

(2) Package Type: SOT353

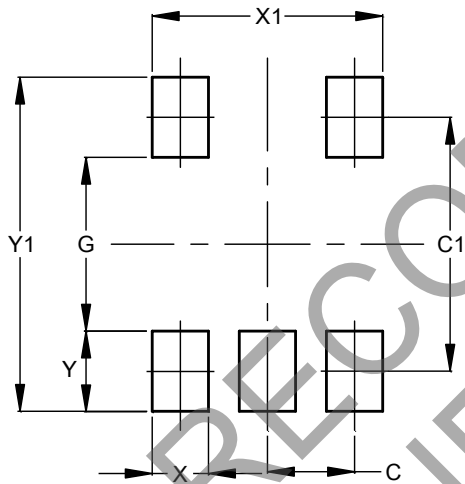

Dimensions	Value (in mm)
C	0.650
C1	1.900
G	1.300
X	0.420
X1	1.720
Y	0.600
Y1	2.500

NOT RECOMMENDED FOR NEW DESIGN

IMPORTANT NOTICE

DIODES INCORPORATED MAKES NO WARRANTY OF ANY KIND, EXPRESS OR IMPLIED, WITH REGARDS TO THIS DOCUMENT, INCLUDING, BUT NOT LIMITED TO, THE IMPLIED WARRANTIES OF MERCHANTABILITY AND FITNESS FOR A PARTICULAR PURPOSE (AND THEIR EQUIVALENTS UNDER THE LAWS OF ANY JURISDICTION).

Diodes Incorporated and its subsidiaries reserve the right to make modifications, enhancements, improvements, corrections or other changes without further notice to this document and any product described herein. Diodes Incorporated does not assume any liability arising out of the application or use of this document or any product described herein; neither does Diodes Incorporated convey any license under its patent or trademark rights, nor the rights of others. Any Customer or user of this document or products described herein in such applications shall assume all risks of such use and will agree to hold Diodes Incorporated and all the companies whose products are represented on Diodes Incorporated website, harmless against all damages.

Diodes Incorporated does not warrant or accept any liability whatsoever in respect of any products purchased through unauthorized sales channel. Should Customers purchase or use Diodes Incorporated products for any unintended or unauthorized application, Customers shall indemnify and hold Diodes Incorporated and its representatives harmless against all claims, damages, expenses, and attorney fees arising out of, directly or indirectly, any claim of personal injury or death associated with such unintended or unauthorized application.

Products described herein may be covered by one or more United States, international or foreign patents pending. Product names and markings noted herein may also be covered by one or more United States, international or foreign trademarks.

This document is written in English but may be translated into multiple languages for reference. Only the English version of this document is the final and determinative format released by Diodes Incorporated.

LIFE SUPPORT

Diodes Incorporated products are specifically not authorized for use as critical components in life support devices or systems without the express written approval of the Chief Executive Officer of Diodes Incorporated. As used herein:

A. Life support devices or systems are devices or systems which:

1. are intended to implant into the body, or
2. support or sustain life and whose failure to perform when properly used in accordance with instructions for use provided in the labeling can be reasonably expected to result in significant injury to the user.

B. A critical component is any component in a life support device or system whose failure to perform can be reasonably expected to cause the failure of the life support device or to affect its safety or effectiveness.

Customers represent that they have all necessary expertise in the safety and regulatory ramifications of their life support devices or systems, and acknowledge and agree that they are solely responsible for all legal, regulatory and safety-related requirements concerning their products and any use of Diodes Incorporated products in such safety-critical, life support devices or systems, notwithstanding any devices- or systems-related information or support that may be provided by Diodes Incorporated. Further, Customers must fully indemnify Diodes Incorporated and its representatives against any damages arising out of the use of Diodes Incorporated products in such safety-critical, life support devices or systems.

Copyright © 2017, Diodes Incorporated

www.diodes.com

Looking for pricing, stock, or lifecycle information?

Click below to explore more details on WIN SOURCE:

 [View AP7115-15SEG-7 on WIN SOURCE](#)

 [Diodes Incorporated](#) Information

Optimize Your Supply Chain with WIN SOURCE Solutions

-  Global Sourcing Solution
-  Obsolete Management
-  Cost Control Management
-  Shortage Management
-  Alternative Solution
-  Excess Inventory Management