



# THE DATASHEET OF TLE2082IP



# TLE208x, TLE208xA, TLE208xY EXCALIBUR HIGH-SPEED JFET-INPUT OPERATIONAL AMPLIFIERS

SLOS182B – FEBRUARY 1997 – REVISED JUNE 2001

- Direct Upgrades to TL05x, TL07x, and TL08x BiFET Operational Amplifiers
- Greater Than 2× Bandwidth (10 MHz) and 3× Slew Rate (45 V/μs) Than TL08x
- On-Chip Offset Voltage Trimming for Improved DC Performance
- Wider Supply Rails Increase Dynamic Signal Range to ±19 V

## description

The TLE208x series of JFET-input operational amplifiers more than double the bandwidth and triple the slew rate of the TL07x and TL08x families of BiFET operational amplifiers. The TLE208x also have wider supply-voltage rails, increasing the dynamic-signal range for BiFET circuits to ±19 V. On-chip zener trimming of offset voltage yields precision grades for greater accuracy in dc-coupled applications. The TLE208x are pin-compatible with lower performance BiFET operational amplifiers for ease in improving performance in existing designs.

BiFET operational amplifiers offer the inherently higher input impedance of the JFET-input transistors, without sacrificing the output drive associated with bipolar amplifiers. This makes these amplifiers better suited for interfacing with high-impedance sensors or very low level ac signals. They also feature inherently better ac response than bipolar or CMOS devices having comparable power consumption.

Because BiFET operational amplifiers are designed for use with dual power supplies, care must be taken to observe common-mode input-voltage limits and output voltage swing when operating from a single supply. DC biasing of the input signal is required and loads should be terminated to a virtual ground node at mid-supply. Texas Instruments TLE2426 integrated virtual ground generator is useful when operating BiFET amplifiers from single supplies.

The TLE208x are fully specified at ±15 V and ±5 V. For operation in low-voltage and/or single-supply systems, Texas Instruments LinCMOS™ families of operational amplifiers (TLC- and TLV-prefix) are recommended. When moving from BiFET to CMOS amplifiers, particular attention should be paid to slew rate and bandwidth requirements and output loading.

For BiFET circuits requiring low noise and/or tighter dc precision, the TLE207x offer the same ac response as the TLE208x with more stringent dc and noise specifications.



Please be aware that an important notice concerning availability, standard warranty, and use in critical applications of Texas Instruments semiconductor products and disclaimers thereto appears at the end of this data sheet.

LinCMOS is a trademark of Texas Instruments.

PRODUCTION DATA information is current as of publication date. Products conform to specifications per the terms of Texas Instruments standard warranty. Production processing does not necessarily include testing of all parameters.



POST OFFICE BOX 655303 • DALLAS, TEXAS 75265

Copyright © 2001, Texas Instruments Incorporated

# TLE208x, TLE208xA, TLE208xY EXCALIBUR HIGH-SPEED JFET-INPUT OPERATIONAL AMPLIFIERS

SLOS182B – FEBRUARY 1997 – REVISED JUNE 2001

## TLE2081 AVAILABLE OPTIONS

| T <sub>A</sub> | V <sub>IOmax</sub><br>AT 25°C | PACKAGED DEVICES        |                           |                           |                         | CHIP<br>FORM<br>(Y) |
|----------------|-------------------------------|-------------------------|---------------------------|---------------------------|-------------------------|---------------------|
|                |                               | SMALL<br>OUTLINE<br>(D) | CHIP<br>CARRIER<br>(FK)   | CERAMIC<br>DIP<br>(JG)    | PLASTIC<br>DIP<br>(P)   |                     |
| 0°C to 70°C    | 3 mV<br>6 mV                  | TLE2081ACD<br>TLE2081CD | —                         | —                         | TLE2081ACP<br>TLE2081CP | —<br>TLE2081Y       |
| –40°C to 85°C  | 3 mV<br>6 mV                  | TLE2081AID<br>TLE2081ID | —                         | —                         | TLE2081AIP<br>TLE2081IP | —                   |
| –55°C to 125°C | 3 mV<br>6 mV                  | —                       | TLE2081AMFK<br>TLE2081MFK | TLE2081AMJG<br>TLE2081MJG | —                       | —                   |

† The D packages are available taped and reeled. Add R suffix to device type (e.g., TLE2081ACDR).

‡ Chip forms are tested at T<sub>A</sub> = 25°C only.

## TLE2082 AVAILABLE OPTIONS

| T <sub>A</sub> | V <sub>IOmax</sub><br>AT 25°C | PACKAGED DEVICES        |                           |                           |                         | CHIP FORM<br>(Y) |
|----------------|-------------------------------|-------------------------|---------------------------|---------------------------|-------------------------|------------------|
|                |                               | SMALL<br>OUTLINE<br>(D) | CHIP<br>CARRIER<br>(FK)   | CERAMIC<br>DIP<br>(JG)    | PLASTIC<br>DIP<br>(P)   |                  |
| 0°C to 70°C    | 4 mV<br>7 mV                  | TLE2082ACD<br>TLE2082CD | —                         | —                         | TLE2082ACP<br>TLE2082CP | —                |
| –40°C to 85°C  | 4 mV<br>7 mV                  | TLE2082AID<br>TLE2082ID | —                         | —                         | TLE2082AIP<br>TLE2082IP | TLE2082Y         |
| –55°C to 125°C | 4 mV<br>7 mV                  | TLE2082AMD<br>TLE2082MD | TLE2082AMFK<br>TLE2082MFK | TLE2082AMJG<br>TLE2082MJG | TLE2082AMP<br>TLE2082MP | —                |

† The D packages are available taped and reeled. Add R suffix to device type (e.g., TLE2082ACDR).

‡ Chip forms are tested at T<sub>A</sub> = 25°C only.

## TLE2084 AVAILABLE OPTIONS

| T <sub>A</sub> | V <sub>IOmax</sub><br>AT 25°C | PACKAGED DEVICES          |                           |                         |                         | CHIP<br>FORM<br>(Y) |
|----------------|-------------------------------|---------------------------|---------------------------|-------------------------|-------------------------|---------------------|
|                |                               | SMALL<br>OUTLINE<br>(DW)  | CHIP<br>CARRIER<br>(FK)   | CERAMIC<br>DIP<br>(J)   | PLASTIC<br>DIP<br>(N)   |                     |
| 0°C to 70°C    | 4 mV<br>7 mV                  | TLE2084ACDW<br>TLE2084CDW | —                         | —                       | TLE2084ACN<br>TLE2084CN | —<br>TLE2084Y       |
| –55°C to 125°C | 4 mV<br>7 mV                  | —                         | TLE2084AMFK<br>TLE2084MFK | TLE2084AMJ<br>TLE2084MJ | —                       | —                   |

† The DW packages are available taped and reeled. Add R suffix to device type (e.g., TLE2084ACDWR).

‡ Chip forms are tested at T<sub>A</sub> = 25°C only.





# TLE208x, TLE208xA, TLE208xY EXCALIBUR HIGH-SPEED JFET-INPUT OPERATIONAL AMPLIFIERS

SLOS182B – FEBRUARY 1997 – REVISED JUNE 2001

## TLE2081Y chip information

This chip, when properly assembled, displays characteristics similar to the TLE2081. Thermal compression or ultrasonic bonding may be used on the doped-aluminum bonding pads. Chips may be mounted with conductive epoxy or a gold-silicon preform.

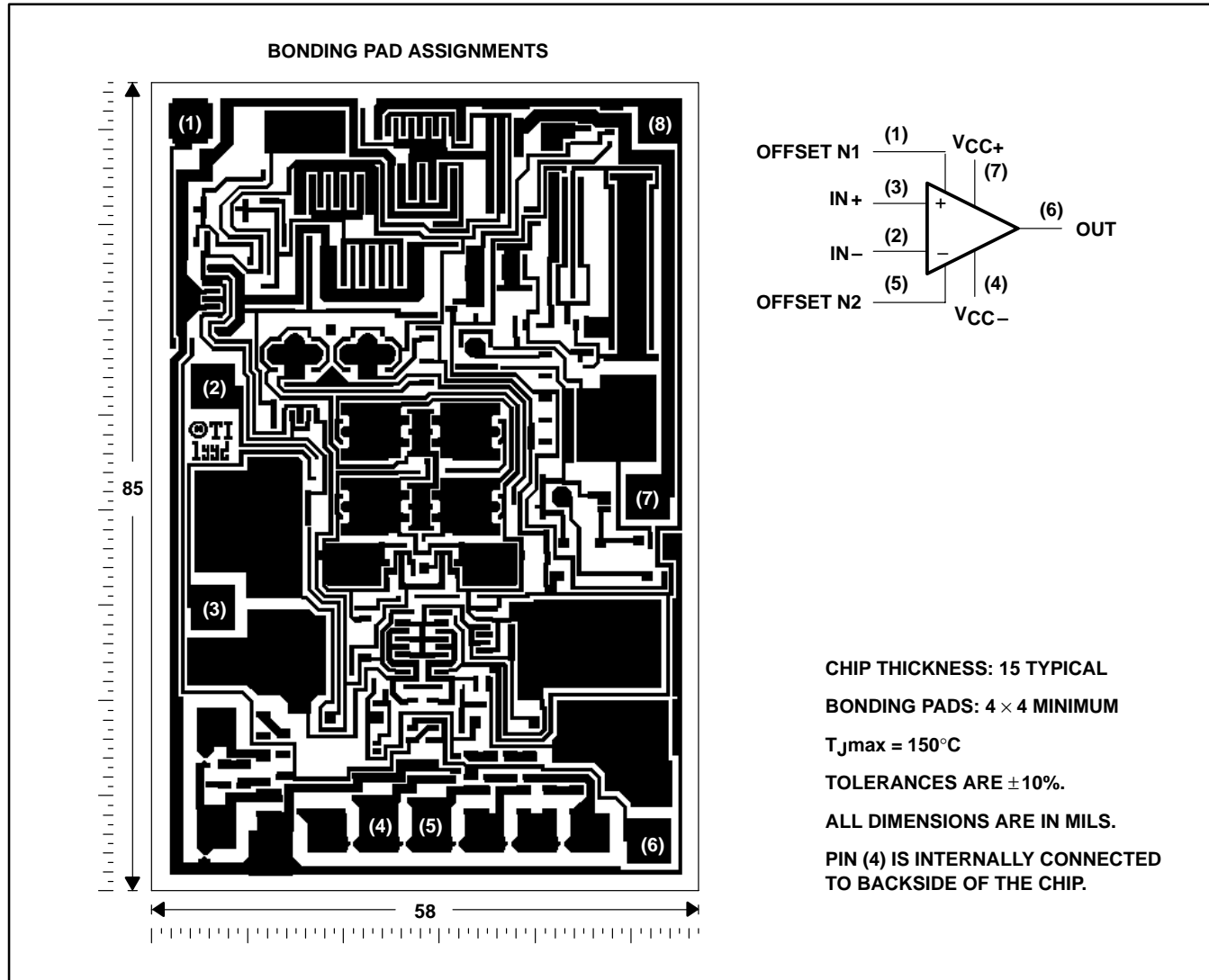

# TLE208x, TLE208xA, TLE208xY EXCALIBUR HIGH-SPEED JFET-INPUT OPERATIONAL AMPLIFIERS

SLOS182B – FEBRUARY 1997 – REVISED JUNE 2001

## TLE2082Y chip information

This chip, when properly assembled, displays characteristics similar to the TLE2082. Thermal compression or ultrasonic bonding may be used on the doped-aluminum bonding pads. Chips may be mounted with conductive epoxy or a gold-silicon preform.

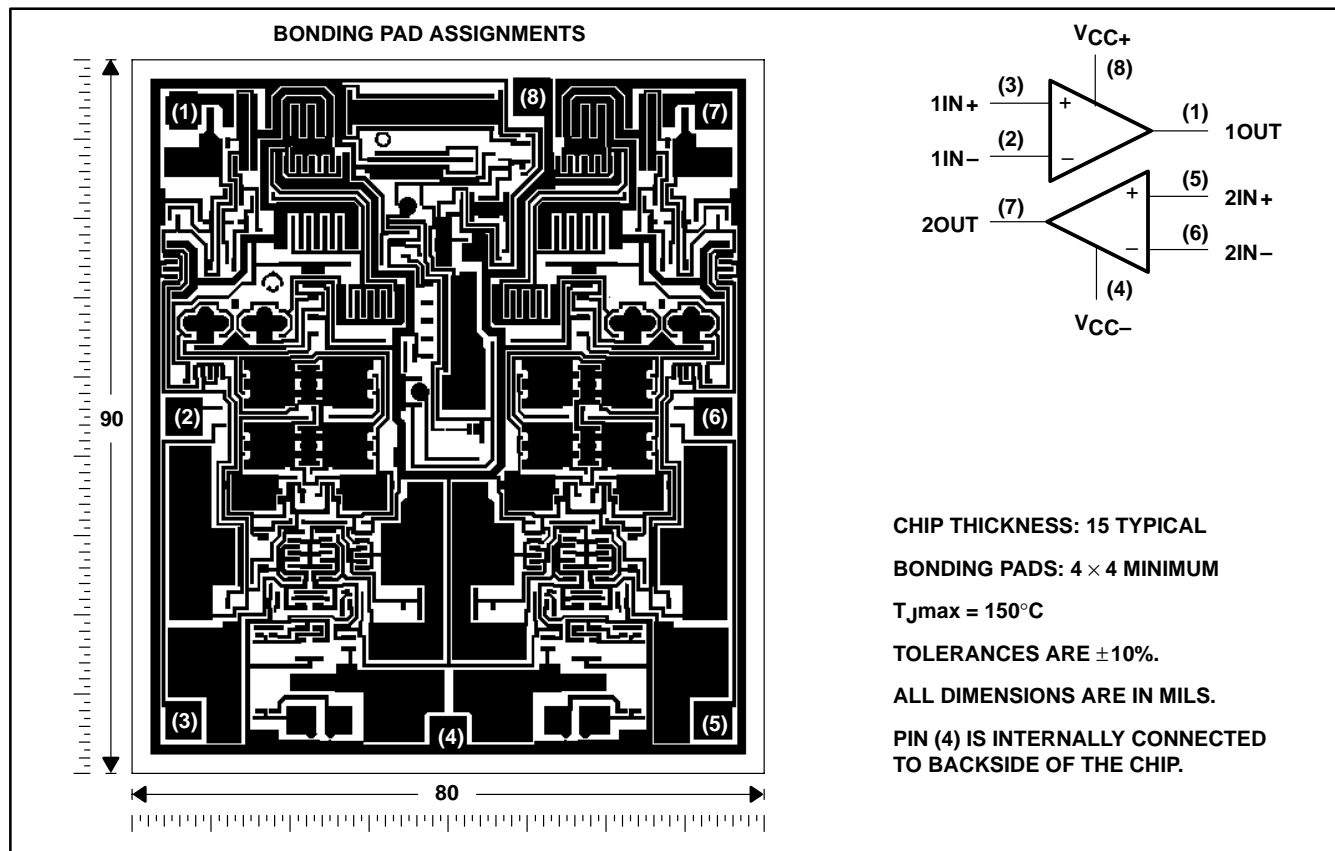

# TLE208x, TLE208xA, TLE208xY EXCALIBUR HIGH-SPEED JFET-INPUT OPERATIONAL AMPLIFIERS

SLOS182B – FEBRUARY 1997 – REVISED JUNE 2001

## TLE2084Y chip information

This chip, when properly assembled, displays characteristics similar to the TLE2084. Thermal compression or ultrasonic bonding may be used on the doped-aluminum bonding pads. Chips may be mounted with conductive epoxy or a gold-silicon preform.

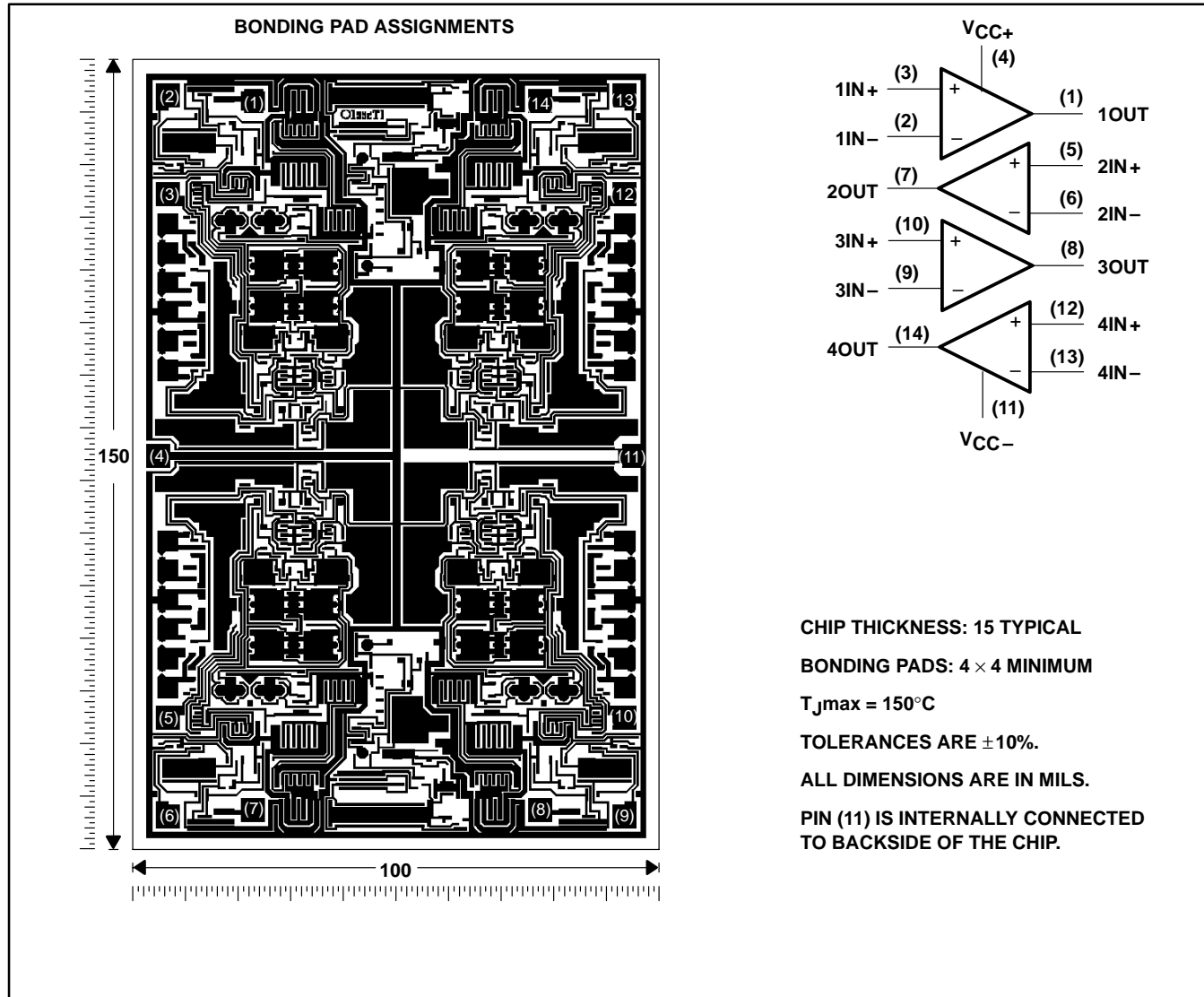

equivalent schematic (each channel)

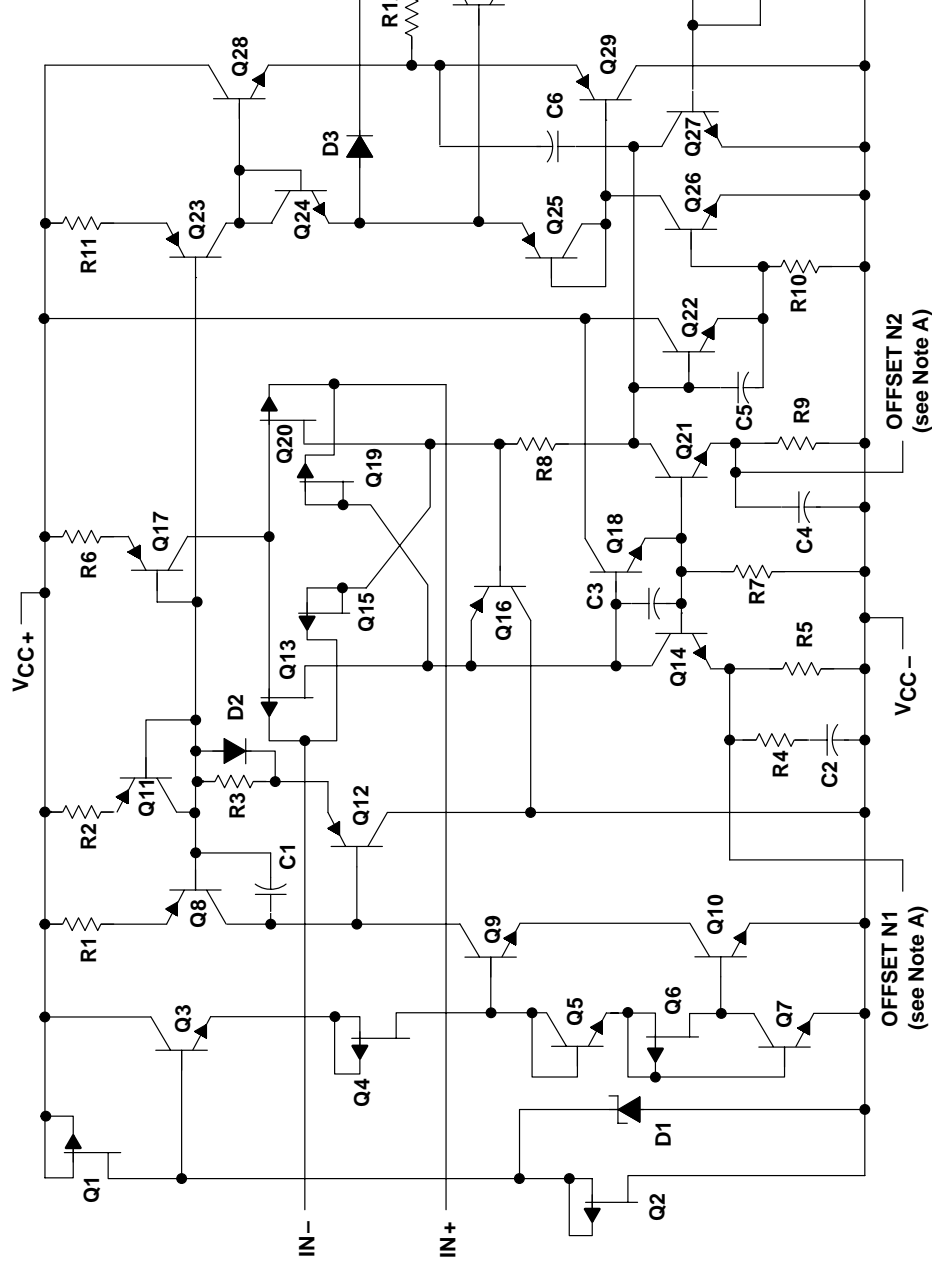

NOTE A: OFFSET N1 and OFFSET N2 are only available on the TLE2081x devices.

| COMPONENT   | ACTUAL DEVICE COMPONENT COUNT |         |         |
|-------------|-------------------------------|---------|---------|
|             | TLE2081                       | TLE2082 | TLE2084 |
| Transistors | 33                            | 57      | 114     |
| Resistors   | 25                            | 37      | 74      |
| Diodes      | 8                             | 5       | 10      |
| Capacitors  | 6                             | 11      | 22      |

# TLE208x, TLE208xA, TLE208xY EXCALIBUR HIGH-SPEED JFET-INPUT OPERATIONAL AMPLIFIERS

SLOS182B – FEBRUARY 1997 – REVISED JUNE 2001

## absolute maximum ratings over operating free-air temperature range (unless otherwise noted)†

|   |                              |
|---|------------------------------|
| Supply voltage, $V_{CC+}$ (see Note 1)  | 19 V                         |
| Supply voltage, $V_{CC-}$ (see Note 1)  | -19 V                        |
| Differential input voltage range, $V_{ID}$ (see Note 2)                       | $V_{CC+}$ to $V_{CC-}$       |
| Input voltage range, $V_I$ (any input)  | $V_{CC+}$ to $V_{CC-}$       |
| Input current, $I_I$ (each input)   | $\pm 1$ mA                   |
| Output current, $I_O$ (each output)   | $\pm 80$ mA                  |
| Total current into $V_{CC+}$  | 160 mA                       |
| Total current out of $V_{CC-}$  | 160 mA                       |
| Duration of short-circuit current at (or below) 25°C (see Note 3)             | unlimited                    |
| Continuous total dissipation  | See Dissipation Rating Table |
| Operating free-air temperature range, $T_A$ : C suffix                        | 0°C to 70°C                  |
| I suffix  | -40°C to 85°C                |
| M suffix  | -55°C to 125°C               |
| Storage temperature range   | -65°C to 150°C               |
| Case temperature for 60 seconds: FK package                                   | 260°C                        |
| Lead temperature 1,6 mm (1/16 inch) from case for 10 seconds: DW or N package | 260°C                        |
| Lead temperature 1,6 mm (1/16 inch) from case for 60 seconds: J package       | 300°C                        |

† Stresses beyond those listed under “absolute maximum ratings” may cause permanent damage to the device. These are stress ratings only, and functional operation of the device at these or any other conditions beyond those indicated under “recommended operating conditions” is not implied. Exposure to absolute-maximum-rated conditions for extended periods may affect device reliability.

NOTES: 1. All voltage values, except differential voltages, are with respect to the midpoint between  $V_{CC+}$  and  $V_{CC-}$ .

2. Differential voltages are at  $IN+$  with respect to  $IN-$ .

3. The output can be shorted to either supply. Temperatures and/or supply voltages must be limited to ensure that the maximum dissipation rate is not exceeded.

DISSIPATION RATING TABLE

| PACKAGE | $T_A \leq 25^\circ\text{C}$ | DERATING FACTOR<br>ABOVE $T_A = 25^\circ\text{C}$ | $T_A = 70^\circ\text{C}$ | $T_A = 85^\circ\text{C}$ | $T_A = 125^\circ\text{C}$ |
|---------|-----------------------------|---|--------------------------|--------------------------|---------------------------|
|         | POWER RATING                |   | POWER RATING             | POWER RATING             | POWER RATING              |
| D       | 725 mW                      | 5.8 mW/°C   | 464 mW                   | 377 mW                   | 145 mW                    |
| DW      | 1025 mW                     | 8.2 mW/°C   | 656 mW                   | 533 mW                   | 205 mW                    |
| FK      | 1375 mW                     | 11.0 mW/°C  | 880 mW                   | 715 mW                   | 275 mW                    |
| J       | 1375 mW                     | 11.0 mW/°C  | 880 mW                   | 715 mW                   | 275 mW                    |
| JG      | 1050 mW                     | 8.4 mW/°C   | 672 mW                   | 546 mW                   | 210 mW                    |
| N       | 1150 mW                     | 9.2 mW/°C   | 736 mW                   | 598 mW                   | 230 mW                    |
| P       | 1000 mW                     | 8.0 mW/°C   | 640 mW                   | 344 mW                   | 200 mW                    |

## recommended operating conditions

|                                       | C SUFFIX               |          | I SUFFIX   |          | M SUFFIX   |          | UNIT |
|---------------------------------------|------------------------|----------|------------|----------|------------|----------|------|
|                                       | MIN                    | MAX      | MIN        | MAX      | MIN        | MAX      |      |
| Supply voltage, $V_{CC\pm}$           | $\pm 2.25$             | $\pm 19$ | $\pm 2.25$ | $\pm 19$ | $\pm 2.25$ | $\pm 19$ | V    |
| Common-mode input voltage, $V_{IC}$   | $V_{CC\pm} = \pm 5$ V  |          | -0.9       | 5        | -0.8       | 5        | V    |
|                                       | $V_{CC\pm} = \pm 15$ V |          | -10.9      | 15       | -10.8      | 15       |      |
| Operating free-air temperature, $T_A$ | 0                      | 70       | -40        | 85       | -55        | 125      | °C   |



**TLE208x, TLE208xA, TLE208xY**  
**EXCALIBUR HIGH-SPEED JFET-INPUT**  
**OPERATIONAL AMPLIFIERS**

SLOS182B – FEBRUARY 1997 – REVISED JUNE 2001

**TLE2081C electrical characteristics at specified free-air temperature,  $V_{CC\pm} = \pm 5$  V (unless otherwise noted)**

| PARAMETER   | TEST CONDITIONS   | $T_A$ †               | TLE2081C   |            |           | TLE2081AC |           |                  | UNIT |
|---|---|-----------------------|------------|------------|-----------|-----------|-----------|------------------|------|
|   |   |                       | MIN        | TYP        | MAX       | MIN       | TYP       | MAX              |      |
| $V_{IO}$ Input offset voltage   | $V_{IC} = 0,$<br>$R_S = 50 \Omega$                                      | $V_O = 0,$            | 25°C       | 0.34       | 6         | 0.3       | 3         | mV               |      |
|   |   |                       | Full range |            |           |           | 5         |                  |      |
| $\alpha_{VIO}$ Temperature coefficient of input offset voltage                  |   |                       | Full range | 3.2        | 29        | 3.2       | 29        | $\mu V/^\circ C$ |      |
| $I_{IO}$ Input offset current   | $V_{IC} = 0,$<br>See Figure 4   | $V_O = 0,$            | 25°C       | 5          | 100       | 5         | 100       | nA               |      |
|   |   |                       | Full range |            |           |           | 1.4       |                  |      |
| $I_{IB}$ Input bias current   |   |                       | 25°C       | 15         | 175       | 15        | 175       | nA               |      |
|   |   |                       | Full range |            |           |           | 5         |                  |      |
| $V_{ICR}$ Common-mode input voltage range                                       | $R_S = 50 \Omega$   |                       | 25°C       | 5 to -1    | 5 to -1.9 | 5 to -1   | 5 to -1.9 | V                |      |
|   |   |                       | Full range |            |           |           | 5 to -0.9 |                  |      |
| $V_{OM+}$ Maximum positive peak output voltage swing                            | $I_O = -200 \mu A$  |                       | 25°C       | 3.8        | 4.1       | 3.8       | 4.1       | V                |      |
|   |   |                       | Full range |            |           |           | 3.7       |                  |      |
|   | $I_O = -2$ mA   |                       | 25°C       | 3.5        | 3.9       | 3.5       | 3.9       |                  |      |
|   |   |                       | Full range |            |           |           | 3.4       |                  |      |
|   | $I_O = -20$ mA  |                       | 25°C       | 1.5        | 2.3       | 1.5       | 2.3       |                  |      |
|   |   |                       | Full range |            |           |           | 1.5       |                  |      |
| $V_{OM-}$ Maximum negative peak output voltage swing                            | $I_O = 200 \mu A$   |                       | 25°C       | -3.5       | -4.2      | -3.5      | -4.2      | V                |      |
|   |   |                       | Full range |            |           |           | -3.4      |                  |      |
|   | $I_O = 2$ mA  |                       | 25°C       | -3.7       | -4.1      | -3.7      | -4.1      |                  |      |
|   |   |                       | Full range |            |           |           | -3.6      |                  |      |
|   | $I_O = 20$ mA   |                       | 25°C       | -1.5       | -2.4      | -1.5      | -2.4      |                  |      |
|   |   |                       | Full range |            |           |           | -1.5      |                  |      |
| $A_{VD}$ Large-signal differential voltage amplification                        | $V_O = \pm 2.3$ V   | $R_L = 600 \Omega$    | 25°C       | 80         | 91        | 80        | 91        | dB               |      |
|   |   |                       | Full range |            |           |           | 79        |                  |      |
|   |   | $R_L = 2$ k $\Omega$  |            | 25°C       | 90        | 100       | 90        |                  | 100  |
|   |   |                       |            | Full range |           |           |           |                  | 89   |
|   |   | $R_L = 10$ k $\Omega$ |            | 25°C       | 95        | 106       | 95        |                  | 106  |
|   |   |                       |            | Full range |           |           |           |                  | 94   |
| $r_i$ Input resistance  | $V_{IC} = 0$  |                       | 25°C       | $10^{12}$  |           | $10^{12}$ |           | $\Omega$         |      |
| $c_i$ Input capacitance   | $V_{IC} = 0,$<br>See Figure 5   | Common mode           | 25°C       | 11         |           | 11        |           | pF               |      |
|   |   | Differential          | 25°C       | 2.5        |           | 2.5       |           |                  |      |
| $z_o$ Open-loop output impedance  | $f = 1$ MHz   |                       | 25°C       | 80         |           | 80        |           | $\Omega$         |      |
| CMRR Common-mode rejection ratio  | $V_{IC} = V_{ICRmin},$<br>$V_O = 0,$<br>$R_S = 50 \Omega$               |                       | 25°C       | 70         | 89        | 70        | 89        | dB               |      |
|   |   |                       | Full range |            |           |           | 68        |                  |      |
| $k_{SVR}$ Supply-voltage rejection ratio ( $\Delta V_{CC\pm} / \Delta V_{IO}$ ) | $V_{CC\pm} = \pm 5$ V to $\pm 15$ V,<br>$V_O = 0,$<br>$R_S = 50 \Omega$ |                       | 25°C       | 82         | 99        | 82        | 99        | dB               |      |
|   |   |                       | Full range |            |           |           | 80        |                  |      |

† Full range is 0°C to 70°C.



**TLE208x, TLE208xA, TLE208xY**  
**EXCALIBUR HIGH-SPEED JFET-INPUT**  
**OPERATIONAL AMPLIFIERS**

SLOS182B – FEBRUARY 1997 – REVISED JUNE 2001

**TLE2081C electrical characteristics at specified free-air temperature,  $V_{CC\pm} = \pm 5\text{ V}$  (unless otherwise noted) (continued)**

| PARAMETER | TEST CONDITIONS              | $T_A$ †                | TLE2081C               |      |     | TLE2081AC |      |     | UNIT |    |
|-----------|------------------------------|------------------------|------------------------|------|-----|-----------|------|-----|------|----|
|           |                              |                        | MIN                    | TYP  | MAX | MIN       | TYP  | MAX |      |    |
| $I_{CC}$  | Supply current               | $V_O = 0$ ,<br>No load | 25°C                   | 1.35 | 1.6 | 2.2       | 1.35 | 1.6 | 2.2  | mA |
|           |                              |                        | Full range             | 2.2  |     |           | 2.2  |     |      |    |
| $I_{OS}$  | Short-circuit output current | $V_O = 0$              | $V_{ID} = 1\text{ V}$  | -35  |     |           | -35  |     |      | mA |
|           |                              |                        | $V_{ID} = -1\text{ V}$ | 45   |     |           | 45   |     |      |    |

† Full range is 0°C to 70°C.

**TLE2081C operating characteristics at specified free-air temperature,  $V_{CC\pm} = \pm 5\text{ V}$**

| PARAMETER   | TEST CONDITIONS                             | $T_A$ †  | TLE2081C            |        |     | TLE2081AC |        |     | UNIT |                        |
|-------------|---|--|---------------------|--------|-----|-----------|--------|-----|------|------------------------|
|             |   |  | MIN                 | TYP    | MAX | MIN       | TYP    | MAX |      |                        |
| SR+         | Positive slew rate                          | $V_{O(PP)} = \pm 2.3\text{ V}$ ,<br>$A_{VD} = -1$ , $R_L = 2\text{ k}\Omega$ ,<br>$C_L = 100\text{ pF}$ , See Figure 1 | 25°C                | 35     |     |           | 35     |     |      | V/ $\mu$ s             |
|             |   |  | Full range          | 23     |     |           | 23     |     |      |                        |
| SR-         | Negative slew rate                          | $V_{O(PP)} = \pm 2.3\text{ V}$ ,<br>$A_{VD} = -1$ , $R_L = 2\text{ k}\Omega$ ,<br>$C_L = 100\text{ pF}$ , See Figure 1 | 25°C                | 38     |     |           | 38     |     |      | V/ $\mu$ s             |
|             |   |  | Full range          | 23     |     |           | 23     |     |      |                        |
| $t_s$       | Settling time                               | $A_{VD} = -1$ ,<br>2-V step,<br>$R_L = 1\text{ k}\Omega$ ,<br>$C_L = 100\text{ pF}$                                    | To 10 mV            | 0.25   |     |           | 0.25   |     |      | $\mu$ s                |
|             |   |  | To 1 mV             | 0.4    |     |           | 0.4    |     |      |                        |
| $V_n$       | Equivalent input noise voltage              | $R_S = 20\ \Omega$ ,<br>See Figure 3   | f = 10 Hz           | 28     |     |           | 28     |     |      | nV/ $\sqrt{\text{Hz}}$ |
|             |   |  | f = 10 kHz          | 11.6   |     |           | 11.6   |     |      |                        |
| $V_{N(PP)}$ | Peak-to-peak equivalent input noise voltage | $R_S = 20\ \Omega$ ,<br>See Figure 3   | f = 10 Hz to 10 kHz | 6      |     |           | 6      |     |      | $\mu$ V                |
|             |   |  | f = 0.1 Hz to 10 Hz | 0.6    |     |           | 0.6    |     |      |                        |
| $I_n$       | Equivalent input noise current              | $V_{IC} = 0$ , f = 10 kHz  | 25°C                | 2.8    |     |           | 2.8    |     |      | fA/ $\sqrt{\text{Hz}}$ |
| THD + N     | Total harmonic distortion plus noise        | $V_{O(PP)} = 5\text{ V}$ , $A_{VD} = 10$ ,<br>f = 1 kHz, $R_L = 2\text{ k}\Omega$ ,<br>$R_S = 25\ \Omega$              | 25°C                | 0.013% |     |           | 0.013% |     |      |                        |
| $B_1$       | Unity-gain bandwidth                        | $V_I = 10\text{ mV}$ , $R_L = 2\text{ k}\Omega$ ,<br>$C_L = 25\text{ pF}$ , See Figure 2                               | 25°C                | 9.4    |     |           | 9.4    |     |      | MHz                    |
| $B_{OM}$    | Maximum output-swing bandwidth              | $V_{O(PP)} = 4\text{ V}$ , $A_{VD} = -1$ ,<br>$R_L = 2\text{ k}\Omega$ , $C_L = 25\text{ pF}$                          | 25°C                | 2.8    |     |           | 2.8    |     |      | MHz                    |
| $\phi_m$    | Phase margin at unity gain                  | $V_I = 10\text{ mV}$ , $R_L = 2\text{ k}\Omega$ ,<br>$C_L = 25\text{ pF}$ , See Figure 2                               | 25°C                | 56°    |     |           | 56°    |     |      |                        |

† Full range is 0°C to 70°C.



**TLE208x, TLE208xA, TLE208xY**  
**EXCALIBUR HIGH-SPEED JFET-INPUT**  
**OPERATIONAL AMPLIFIERS**

SLOS182B – FEBRUARY 1997 – REVISED JUNE 2001

**TLE2081C electrical characteristics at specified free-air temperature,  $V_{CC\pm} = \pm 15\text{ V}$  (unless otherwise noted)**

| PARAMETER   | TEST CONDITIONS   | $T_A$ †                    | TLE2081C    |             |     | TLE2081AC   |             |                              | UNIT     |    |
|---|---|----------------------------|-------------|-------------|-----|-------------|-------------|------------------------------|----------|----|
|   |   |                            | MIN         | TYP         | MAX | MIN         | TYP         | MAX                          |          |    |
| $V_{IO}$ Input offset voltage   | $V_{IC} = 0, V_O = 0, R_S = 50\ \Omega$                                       | 25°C                       | 0.49        | 6           |     | 0.47        | 3           | mV                           |          |    |
|   |   | Full range                 |             |             | 8   |             | 5           |                              |          |    |
| $\alpha_{VIO}$ Temperature coefficient of input offset voltage                |   | Full range                 | 3.2         | 29          |     | 3.2         | 29          | $\mu\text{V}/^\circ\text{C}$ |          |    |
| $I_{IO}$ Input offset current   | $V_{IC} = 0, V_O = 0, \text{See Figure 4}$                                    | 25°C                       | 6           | 100         |     | 6           | 100         | nA                           |          |    |
|   |   | Full range                 |             | 1.4         |     |             | 1.4         |                              |          |    |
| $I_{IB}$ Input bias current   |   | 25°C                       | 20          | 175         |     | 20          | 175         | nA                           |          |    |
|   |   | Full range                 |             | 5           |     |             | 5           |                              |          |    |
| $V_{ICR}$ Common-mode input voltage range                                     | $R_S = 50\ \Omega$  | 25°C                       | 15 to -11   | 15 to -11.9 |     | 15 to -11   | 15 to -11.9 | V                            |          |    |
|   |   | Full range                 | 15 to -10.9 |             |     | 15 to -10.9 |             |                              |          |    |
| $V_{OM+}$ Maximum positive peak output voltage swing                          | $I_O = -200\ \mu\text{A}$   | 25°C                       | 13.8        | 14.1        |     | 13.8        | 14.1        | V                            |          |    |
|   |   | Full range                 | 13.7        |             |     | 13.7        |             |                              |          |    |
|   | $I_O = -2\ \text{mA}$   | 25°C                       | 13.5        | 13.9        |     | 13.5        | 13.9        |                              |          |    |
|   |   | Full range                 | 13.4        |             |     | 13.4        |             |                              |          |    |
|   | $I_O = -20\ \text{mA}$  | 25°C                       | 11.5        | 12.3        |     | 11.5        | 12.3        |                              |          |    |
|   |   | Full range                 | 11.5        |             |     | 11.5        |             |                              |          |    |
| $V_{OM-}$ Maximum negative peak output voltage swing                          | $I_O = 200\ \mu\text{A}$  | 25°C                       | -13.8       | -14.2       |     | -13.8       | -14.2       | V                            |          |    |
|   |   | Full range                 | -13.7       |             |     | -13.7       |             |                              |          |    |
|   | $I_O = 2\ \text{mA}$  | 25°C                       | -13.5       | -14         |     | -13.5       | -14         |                              |          |    |
|   |   | Full range                 | -13.4       |             |     | -13.4       |             |                              |          |    |
|   | $I_O = 20\ \text{mA}$   | 25°C                       | -11.5       | -12.4       |     | -11.5       | -12.4       |                              |          |    |
|   |   | Full range                 | -11.5       |             |     | -11.5       |             |                              |          |    |
| $A_{VD}$ Large-signal differential voltage amplification                      | $V_O = \pm 10\ \text{V}$  | $R_L = 600\ \Omega$        | 25°C        | 80          | 96  |             | 80          | 96                           | dB       |    |
|   |   |                            | Full range  | 79          |     |             | 79          |                              |          |    |
|   |   | $R_L = 2\ \text{k}\Omega$  | 25°C        | 90          | 109 |             | 90          | 109                          |          |    |
|   |   |                            | Full range  | 89          |     |             | 89          |                              |          |    |
|   |   | $R_L = 10\ \text{k}\Omega$ | 25°C        | 95          | 118 |             | 95          | 118                          |          |    |
|   |   |                            | Full range  | 94          |     |             | 94          |                              |          |    |
| $r_i$ Input resistance  | $V_{IC} = 0$  | 25°C                       | $10^{12}$   |             |     | $10^{12}$   |             |                              | $\Omega$ |    |
| $c_i$ Input capacitance   | $V_{IC} = 0, \text{See Figure 5}$   | Common mode                | 25°C        | 7.5         |     |             | 7.5         |                              |          | pF |
|   |   | Differential               | 25°C        | 2.5         |     |             | 2.5         |                              |          |    |
| $z_o$ Open-loop output impedance  | $f = 1\ \text{MHz}$   | 25°C                       | 80          |             |     | 80          |             |                              | $\Omega$ |    |
| CMRR Common-mode rejection ratio  | $V_{IC} = V_{ICRmin}, V_O = 0, R_S = 50\ \Omega$                              | 25°C                       | 80          | 98          |     | 80          | 98          | dB                           |          |    |
|   |   | Full range                 | 79          |             |     | 79          |             |                              |          |    |
| $k_{SVR}$ Supply-voltage rejection ratio ( $\Delta V_{CC\pm}/\Delta V_{IO}$ ) | $V_{CC\pm} = \pm 5\ \text{V to } \pm 15\ \text{V}, V_O = 0, R_S = 50\ \Omega$ | 25°C                       | 82          | 99          |     | 82          | 99          | dB                           |          |    |
|   |   | Full range                 | 80          |             |     | 81          |             |                              |          |    |

† Full range is 0°C to 70°C.



**TLE208x, TLE208xA, TLE208xY**  
**EXCALIBUR HIGH-SPEED JFET-INPUT**  
**OPERATIONAL AMPLIFIERS**

SLOS182B – FEBRUARY 1997 – REVISED JUNE 2001

**TLE2081C electrical characteristics at specified free-air temperature,  $V_{CC\pm} = \pm 15\text{ V}$  (unless otherwise noted) (continued)**

| PARAMETER                             | TEST CONDITIONS     | $T_A$ †    | TLE2081C               |     |         | TLE2081AC |         |     | UNIT |
|---------------------------------------|---------------------|------------|------------------------|-----|---------|-----------|---------|-----|------|
|                                       |                     |            | MIN                    | TYP | MAX     | MIN       | TYP     | MAX |      |
| $I_{CC}$ Supply current               | $V_O = 0$ , No load | 25°C       | 1.35                   | 1.7 | 2.2     | 1.35      | 1.7     | 2.2 | mA   |
|                                       |                     | Full range | 2.2                    |     |         | 2.2       |         |     |      |
| $I_{OS}$ Short-circuit output current | $V_O = 0$           | 25°C       | $V_{ID} = 1\text{ V}$  |     | -30 -45 |           | -30 -45 |     | mA   |
|                                       |                     |            | $V_{ID} = -1\text{ V}$ |     | 30 48   |           | 30 48   |     |      |

† Full range is 0°C to 70°C.

**TLE2081C operating characteristics at specified free-air temperature,  $V_{CC\pm} = \pm 15\text{ V}$**

| PARAMETER   | TEST CONDITIONS   | $T_A$ †    | TLE2081C            |     |        | TLE2081AC |                        |     | UNIT                   |
|---|---|------------|---------------------|-----|--------|-----------|------------------------|-----|------------------------|
|   |   |            | MIN                 | TYP | MAX    | MIN       | TYP                    | MAX |                        |
| SR+ Positive slew rate                                  | $V_{O(PP)} = 10\text{ V}$ , $A_{VD} = -1$ ,<br>$R_L = 2\text{ k}\Omega$ , $C_L = 100\text{ pF}$ ,<br>See Figure 1 | 25°C       | 30                  | 40  |        | 30        | 40                     |     | V/ $\mu$ s             |
|   |   | Full range | 27                  |     |        | 27        |                        |     |                        |
| SR- Negative slew rate                                  |   | 25°C       | 30                  | 45  |        | 30        | 45                     |     | V/ $\mu$ s             |
|   |   | Full range | 27                  |     |        | 27        |                        |     |                        |
| $t_s$ Settling time                                     | $A_{VD} = -1$ ,<br>10-V step,<br>$R_L = 1\text{ k}\Omega$ ,<br>$C_L = 100\text{ pF}$                              | 25°C       | To 10 mV            |     | 0.4    |           | 0.4                    |     | $\mu$ s                |
|   |   |            | To 1 mV             |     | 1.5    |           | 1.5                    |     |                        |
| $V_n$ Equivalent input noise voltage                    | $R_S = 20\ \Omega$ ,<br>See Figure 3  | 25°C       | f = 10 Hz           |     | 28     |           | 28                     |     | nV/ $\sqrt{\text{Hz}}$ |
|   |   |            | f = 10 kHz          |     | 11.6   |           | 11.6                   |     |                        |
| $V_{N(PP)}$ Peak-to-peak equivalent input noise voltage |   | 25°C       | f = 10 Hz to 10 kHz |     | 6      |           | 6                      |     | $\mu$ V                |
|   |   |            | f = 0.1 Hz to 10 Hz |     | 0.6    |           | 0.6                    |     |                        |
| $I_n$ Equivalent input noise current                    | $V_{IC} = 0$ , f = 10 kHz   | 25°C       | 2.8                 |     | 2.8    |           | fA/ $\sqrt{\text{Hz}}$ |     |                        |
| THD + N Total harmonic distortion plus noise            | $V_{O(PP)} = 20\text{ V}$ , $A_{VD} = 10$ ,<br>f = 1 kHz, $R_L = 2\text{ k}\Omega$ ,<br>$R_S = 25\ \Omega$        | 25°C       | 0.008%              |     | 0.008% |           |                        |     |                        |
| $B_1$ Unity-gain bandwidth                              | $V_I = 10\text{ mV}$ , $R_L = 2\text{ k}\Omega$ ,<br>$C_L = 25\text{ pF}$ , See Figure 2                          | 25°C       | 8                   | 10  |        | 8         | 10                     | MHz |                        |
| $B_{OM}$ Maximum output-swing bandwidth                 | $V_{O(PP)} = 20\text{ V}$ , $A_{VD} = -1$ ,<br>$R_L = 2\text{ k}\Omega$ , $C_L = 25\text{ pF}$                    | 25°C       | 478                 | 637 |        | 478       | 637                    | kHz |                        |
| $\phi_m$ Phase margin at unity gain                     | $V_I = 10\text{ mV}$ , $R_L = 2\text{ k}\Omega$ ,<br>$C_L = 25\text{ pF}$ , See Figure 2                          | 25°C       | 57°                 |     | 57°    |           |                        |     |                        |

† Full range is 0°C to 70°C.



**TLE208x, TLE208xA, TLE208xY**  
**EXCALIBUR HIGH-SPEED JFET-INPUT**  
**OPERATIONAL AMPLIFIERS**

SLOS182B – FEBRUARY 1997 – REVISED JUNE 2001

**TLE2081I electrical characteristics at specified free-air temperature,  $V_{CC\pm} = \pm 5\text{ V}$  (unless otherwise noted)**

| PARAMETER   | TEST CONDITIONS  | $T_A$ †                    | TLE2081I   |           |      | TLE2081AI |           |      | UNIT                         |    |
|---|--|----------------------------|------------|-----------|------|-----------|-----------|------|------------------------------|----|
|   |  |                            | MIN        | TYP       | MAX  | MIN       | TYP       | MAX  |                              |    |
| $V_{IO}$ Input offset voltage   | $V_{IC} = 0,$<br>$R_S = 50\ \Omega,$<br>$V_O = 0,$                                       | 25°C                       | 0.34       |           | 6    | 0.3       |           | 3    | mV                           |    |
|   |  | Full range                 |            |           | 7.6  |           |           | 5.6  |                              |    |
| $\alpha_{VIO}$ Temperature coefficient of input offset voltage                |  | Full range                 | 3.2        |           | 29   | 3.2       |           | 29   | $\mu\text{V}/^\circ\text{C}$ |    |
| $I_{IO}$ Input offset current   | $V_{IC} = 0,$<br>$V_O = 0,$<br>See Figure 4  | 25°C                       | 5          |           | 100  | 5         |           | 100  | pA                           |    |
|   |  | Full range                 |            |           | 5    |           |           | 5    | nA                           |    |
| $I_{IB}$ Input bias current   |  | 25°C                       | 15         |           | 175  | 15        |           | 175  | pA                           |    |
|   |  | Full range                 |            |           | 10   |           |           | 10   | nA                           |    |
| $V_{ICR}$ Common-mode input voltage range                                     | $R_S = 50\ \Omega$   | 25°C                       | 5 to -1    | 5 to -1.9 |      | 5 to -1   | 5 to -1.9 |      | V                            |    |
|   |  | Full range                 | 5 to -0.8  |           |      | 5 to -0.8 |           |      |                              |    |
| $V_{OM+}$ Maximum positive peak output voltage swing                          | $I_O = -200\ \mu\text{A}$  | 25°C                       | 3.8        |           | 4.1  | 3.8       |           | 4.1  | V                            |    |
|   |  | Full range                 |            |           | 3.7  |           |           | 3.7  |                              |    |
|   | $I_O = -2\ \text{mA}$  | 25°C                       | 3.5        |           | 3.9  | 3.5       |           | 3.9  |                              |    |
|   |  | Full range                 |            |           | 3.4  |           |           | 3.4  |                              |    |
|   | $I_O = -20\ \text{mA}$   | 25°C                       | 1.5        |           | 2.3  | 1.5       |           | 2.3  |                              |    |
|   |  | Full range                 |            |           | 1.5  |           |           | 1.5  |                              |    |
| $V_{OM-}$ Maximum negative peak output voltage swing                          | $I_O = 200\ \mu\text{A}$   | 25°C                       | -3.8       |           | -4.2 | -3.8      |           | -4.2 | V                            |    |
|   |  | Full range                 |            |           | -3.7 |           |           | -3.7 |                              |    |
|   | $I_O = 2\ \text{mA}$   | 25°C                       | -3.5       |           | -4.1 | -3.5      |           | -4.1 |                              |    |
|   |  | Full range                 |            |           | -3.4 |           |           | -3.4 |                              |    |
|   | $I_O = 20\ \text{mA}$  | 25°C                       | -1.5       |           | -2.4 | -1.5      |           | -2.4 |                              |    |
|   |  | Full range                 |            |           | -1.5 |           |           | -1.5 |                              |    |
| $A_{VD}$ Large-signal differential voltage amplification                      | $V_O = \pm 2.3\ \text{V}$  | $R_L = 600\ \Omega$        | 25°C       | 80        |      | 91        | 80        |      | 91                           | dB |
|   |  |                            | Full range |           |      | 79        |           |      | 79                           |    |
|   |  | $R_L = 2\ \text{k}\Omega$  | 25°C       | 90        |      | 100       | 90        |      | 100                          |    |
|   |  |                            | Full range |           |      | 89        |           |      | 89                           |    |
|   |  | $R_L = 10\ \text{k}\Omega$ | 25°C       | 95        |      | 106       | 95        |      | 106                          |    |
|   |  |                            | Full range |           |      | 94        |           |      | 94                           |    |
| $r_i$ Input resistance  | $V_{IC} = 0$   | 25°C                       | $10^{12}$  |           |      | $10^{12}$ |           |      | $\Omega$                     |    |
| $c_i$ Input capacitance   | $V_{IC} = 0,$<br>See Figure 5  | Common mode                | 25°C       | 11        |      |           | 11        |      |                              | pF |
|   |  | Differential               | 25°C       | 2.5       |      |           | 2.5       |      |                              |    |
| $z_o$ Open-loop output impedance  | $f = 1\ \text{MHz}$  | 25°C                       | 80         |           |      | 80        |           |      | $\Omega$                     |    |
| CMRR Common-mode rejection ratio  | $V_{IC} = V_{ICRmin},$<br>$V_O = 0,$<br>$R_S = 50\ \Omega$                               | 25°C                       | 70         |           | 89   | 70        |           | 89   | dB                           |    |
|   |  | Full range                 |            |           | 68   |           |           | 68   |                              |    |
| $k_{SVR}$ Supply-voltage rejection ratio ( $\Delta V_{CC\pm}/\Delta V_{IO}$ ) | $V_{CC\pm} = \pm 5\ \text{V}$ to $\pm 15\ \text{V},$<br>$V_O = 0,$<br>$R_S = 50\ \Omega$ | 25°C                       | 82         |           | 99   | 82        |           | 99   | dB                           |    |
|   |  | Full range                 |            |           | 80   |           |           | 80   |                              |    |

† Full range is  $-40^\circ\text{C}$  to  $85^\circ\text{C}$ .



**TLE208x, TLE208xA, TLE208xY**  
**EXCALIBUR HIGH-SPEED JFET-INPUT**  
**OPERATIONAL AMPLIFIERS**

SLOS182B – FEBRUARY 1997 – REVISED JUNE 2001

**TLE2081I electrical characteristics at specified free-air temperature,  $V_{CC\pm} = \pm 5\text{ V}$  (unless otherwise noted) (continued)**

| PARAMETER                             | TEST CONDITIONS     | $T_A$ †                | TLE2081I |     |     | TLE2081AI |     |     | UNIT |
|---------------------------------------|---------------------|------------------------|----------|-----|-----|-----------|-----|-----|------|
|                                       |                     |                        | MIN      | TYP | MAX | MIN       | TYP | MAX |      |
| $I_{CC}$ Supply current               | $V_O = 0$ , No load | 25°C                   | 1.35     | 1.6 | 2.2 | 1.35      | 1.6 | 2.2 | mA   |
|                                       |                     | Full range             | 2.2      |     |     | 2.2       |     |     |      |
| $I_{OS}$ Short-circuit output current | $V_O = 0$           | $V_{ID} = 1\text{ V}$  | -35      |     |     | -35       |     |     | mA   |
|                                       |                     | $V_{ID} = -1\text{ V}$ | 45       |     |     | 45        |     |     |      |

† Full range is  $-40^\circ\text{C}$  to  $85^\circ\text{C}$ .

**TLE2081I operating characteristics at specified free-air temperature,  $V_{CC\pm} = \pm 5\text{ V}$**

| PARAMETER   | TEST CONDITIONS  | $T_A$ †             | TLE2081I |     |     | TLE2081AI |     |     | UNIT                         |
|---|--|---------------------|----------|-----|-----|-----------|-----|-----|------------------------------|
|   |  |                     | MIN      | TYP | MAX | MIN       | TYP | MAX |                              |
| SR+ Positive slew rate                                  | $V_{O(PP)} = \pm 2.3\text{ V}$ ,<br>$A_{VD} = -1$ , $R_L = 2\text{ k}\Omega$ ,<br>$C_L = 100\text{ pF}$ , See Figure 1 | 25°C                | 35       |     |     | 35        |     |     | $\text{V}/\mu\text{s}$       |
|   |  | Full range          | 22       |     |     | 22        |     |     |                              |
| SR- Negative slew rate                                  |  | 25°C                | 38       |     |     | 38        |     |     | $\text{V}/\mu\text{s}$       |
|   |  | Full range          | 22       |     |     | 22        |     |     |                              |
| $t_s$ Settling time                                     | $A_{VD} = -1$ ,<br>2-V step,<br>$R_L = 1\text{ k}\Omega$ ,<br>$C_L = 100\text{ pF}$                                    | To 10 mV            | 0.25     |     |     | 0.25      |     |     | $\mu\text{s}$                |
|   |  | To 1 mV             | 0.4      |     |     | 0.4       |     |     |                              |
| $V_n$ Equivalent input noise voltage                    | $R_S = 20\ \Omega$ ,<br>See Figure 3   | f = 10 Hz           | 28       |     |     | 28        |     |     | $\text{nV}/\sqrt{\text{Hz}}$ |
|   |  | f = 10 kHz          | 11.6     |     |     | 11.6      |     |     |                              |
| $V_{N(PP)}$ Peak-to-peak equivalent input noise voltage |  | f = 10 Hz to 10 kHz | 6        |     |     | 6         |     |     | $\mu\text{V}$                |
|   |  | f = 0.1 Hz to 10 Hz | 0.6      |     |     | 0.6       |     |     |                              |
| $I_n$ Equivalent input noise current                    | $V_{IC} = 0$ , f = 10 kHz  | 25°C                | 2.8      |     |     | 2.8       |     |     | $\text{fA}/\sqrt{\text{Hz}}$ |
| THD + N Total harmonic distortion plus noise            | $V_{O(PP)} = 5\text{ V}$ , $A_{VD} = 10$ ,<br>f = 1 kHz, $R_L = 2\text{ k}\Omega$ ,<br>$R_S = 25\ \Omega$              | 25°C                | 0.013%   |     |     | 0.013%    |     |     |                              |
| $B_1$ Unity-gain bandwidth                              | $V_I = 10\text{ mV}$ , $R_L = 2\text{ k}\Omega$ ,<br>$C_L = 25\text{ pF}$ , See Figure 2                               | 25°C                | 9.4      |     |     | 9.4       |     |     | MHz                          |
| $B_{OM}$ Maximum output-swing bandwidth                 | $V_{O(PP)} = 4\text{ V}$ , $A_{VD} = -1$ ,<br>$R_L = 2\text{ k}\Omega$ , $C_L = 25\text{ pF}$                          | 25°C                | 2.8      |     |     | 2.8       |     |     | MHz                          |
| $\phi_m$ Phase margin at unity gain                     | $V_I = 10\text{ mV}$ , $R_L = 2\text{ k}\Omega$ ,<br>$C_L = 25\text{ pF}$ , See Figure 2                               | 25°C                | 56°      |     |     | 56°       |     |     |                              |

† Full range is  $-40^\circ\text{C}$  to  $85^\circ\text{C}$ .



**TLE208x, TLE208xA, TLE208xY**  
**EXCALIBUR HIGH-SPEED JFET-INPUT**  
**OPERATIONAL AMPLIFIERS**

SLOS182B – FEBRUARY 1997 – REVISED JUNE 2001

**TLE20811 electrical characteristics at specified free-air temperature,  $V_{CC\pm} = \pm 15$  V (unless otherwise noted)**

| PARAMETER   | TEST CONDITIONS   | $T_A$ †               | TLE20811    |             |     | TLE2081AI   |             |                  | UNIT     |    |
|---|---|-----------------------|-------------|-------------|-----|-------------|-------------|------------------|----------|----|
|   |   |                       | MIN         | TYP         | MAX | MIN         | TYP         | MAX              |          |    |
| $V_{IO}$ Input offset voltage   | $V_{IC} = 0,$<br>$R_S = 50 \Omega,$<br>$V_O = 0,$                       | 25°C                  | 0.49        | 6           |     | 0.47        | 3           | mV               |          |    |
|   |   | Full range            |             |             | 7.6 |             | 5.6         |                  |          |    |
| $\alpha V_{IO}$ Temperature coefficient of input offset voltage               |   | Full range            | 3.2         | 29          |     | 3.2         | 29          | $\mu V/^\circ C$ |          |    |
| $I_{IO}$ Input offset current   | $V_{IC} = 0,$<br>$V_O = 0,$<br>See Figure 4                             | 25°C                  | 6           | 100         |     | 6           | 100         | pA               |          |    |
|   |   | Full range            |             | 5           |     |             | 5           | nA               |          |    |
| $I_{IB}$ Input bias current   |   | 25°C                  | 20          | 175         |     | 20          | 175         | pA               |          |    |
|   |   | Full range            |             | 10          |     |             | 10          | nA               |          |    |
| $V_{ICR}$ Common-mode input voltage range                                     | $R_S = 50 \Omega$   | 25°C                  | 15 to -11   | 15 to -11.9 |     | 15 to -11   | 15 to -11.9 | V                |          |    |
|   |   | Full range            | 15 to -10.8 |             |     | 15 to -10.8 |             |                  |          |    |
| $V_{OM+}$ Maximum positive peak output voltage swing                          | $I_O = -200 \mu A$  | 25°C                  | 13.8        | 14.1        |     | 13.8        | 14.1        | V                |          |    |
|   |   | Full range            | 13.7        |             |     | 13.7        |             |                  |          |    |
|   | $I_O = -2$ mA   | 25°C                  | 13.5        | 13.9        |     | 13.5        | 13.9        |                  |          |    |
|   |   | Full range            | 13.4        |             |     | 13.4        |             |                  |          |    |
|   | $I_O = -20$ mA  | 25°C                  | 11.5        | 12.3        |     | 11.5        | 12.3        |                  |          |    |
|   |   | Full range            | 11.5        |             |     | 11.5        |             |                  |          |    |
| $V_{OM-}$ Maximum negative peak output voltage swing                          | $I_O = 200 \mu A$   | 25°C                  | -13.8       | -14.2       |     | -13.8       | -14.2       | V                |          |    |
|   |   | Full range            | -13.7       |             |     | -13.7       |             |                  |          |    |
|   | $I_O = 2$ mA  | 25°C                  | -13.5       | -14         |     | -13.5       | -14         |                  |          |    |
|   |   | Full range            | -13.4       |             |     | -13.4       |             |                  |          |    |
|   | $I_O = 20$ mA   | 25°C                  | -11.5       | -12.4       |     | -11.5       | -12.4       |                  |          |    |
|   |   | Full range            | -11.5       |             |     | -11.5       |             |                  |          |    |
| $A_{VD}$ Large-signal differential voltage amplification                      | $V_O = \pm 10$ V  | $R_L = 600 \Omega$    | 25°C        | 80          | 96  |             | 80          | 96               | dB       |    |
|   |   |                       | Full range  | 79          |     |             | 79          |                  |          |    |
|   |   | $R_L = 2$ k $\Omega$  | 25°C        | 90          | 109 |             | 90          | 109              |          |    |
|   |   |                       | Full range  | 89          |     |             | 89          |                  |          |    |
|   |   | $R_L = 10$ k $\Omega$ | 25°C        | 95          | 118 |             | 95          | 118              |          |    |
|   |   |                       | Full range  | 94          |     |             | 94          |                  |          |    |
| $r_i$ Input resistance  | $V_{IC} = 0$  | 25°C                  | $10^{12}$   |             |     | $10^{12}$   |             |                  | $\Omega$ |    |
| $c_i$ Input capacitance   | $V_{IC} = 0,$<br>See Figure 5   | Common mode           | 25°C        | 7.5         |     |             | 7.5         |                  |          | pF |
|   |   | Differential          | 25°C        | 2.5         |     |             | 2.5         |                  |          |    |
| $z_o$ Open-loop output impedance  | $f = 1$ MHz   | 25°C                  | 80          |             |     | 80          |             |                  | $\Omega$ |    |
| CMRR Common-mode rejection ratio  | $V_{IC} = V_{ICRmin},$<br>$V_O = 0,$<br>$R_S = 50 \Omega$               | 25°C                  | 80          | 98          |     | 80          | 98          | dB               |          |    |
|   |   | Full range            | 79          |             |     | 79          |             |                  |          |    |
| $k_{SVR}$ Supply-voltage rejection ratio ( $\Delta V_{CC\pm}/\Delta V_{IO}$ ) | $V_{CC\pm} = \pm 5$ V to $\pm 15$ V,<br>$V_O = 0,$<br>$R_S = 50 \Omega$ | 25°C                  | 82          | 99          |     | 82          | 99          | dB               |          |    |
|   |   | Full range            | 80          |             |     | 80          |             |                  |          |    |

† Full range is  $-40^\circ C$  to  $85^\circ C$ .



**TLE208x, TLE208xA, TLE208xY**  
**EXCALIBUR HIGH-SPEED JFET-INPUT**  
**OPERATIONAL AMPLIFIERS**

SLOS182B – FEBRUARY 1997 – REVISED JUNE 2001

**TLE2081I electrical characteristics at specified free-air temperature,  $V_{CC\pm} = \pm 15\text{ V}$  (unless otherwise noted) (continued)**

| PARAMETER                             | TEST CONDITIONS     | $T_A$ †    | TLE2081I               |     |         | TLE2081AI |         |     | UNIT |
|---------------------------------------|---------------------|------------|------------------------|-----|---------|-----------|---------|-----|------|
|                                       |                     |            | MIN                    | TYP | MAX     | MIN       | TYP     | MAX |      |
| $I_{CC}$ Supply current               | $V_O = 0$ , No load | 25°C       | 1.35                   | 1.7 | 2.2     | 1.35      | 1.7     | 2.2 | mA   |
|                                       |                     | Full range | 2.2                    |     |         | 2.2       |         |     |      |
| $I_{OS}$ Short-circuit output current | $V_O = 0$           | 25°C       | $V_{ID} = 1\text{ V}$  |     | -30 -45 |           | -30 -45 |     | mA   |
|                                       |                     |            | $V_{ID} = -1\text{ V}$ |     | 30 48   |           | 30 48   |     |      |

† Full range is  $-40^\circ\text{C}$  to  $85^\circ\text{C}$ .

**TLE2081I operating characteristics at specified free-air temperature,  $V_{CC\pm} = \pm 15\text{ V}$**

| PARAMETER   | TEST CONDITIONS   | $T_A$ †    | TLE2081I            |     |      | TLE2081AI |      |     | UNIT                   |
|---|---|------------|---------------------|-----|------|-----------|------|-----|------------------------|
|   |   |            | MIN                 | TYP | MAX  | MIN       | TYP  | MAX |                        |
| SR+ Positive slew rate                                  | $V_{O(PP)} = \pm 10\text{ V}$ ,<br>$A_{VD} = -1$ ,<br>$C_L = 100\text{ pF}$ ,<br>$R_L = 2\text{ k}\Omega$ ,<br>See Figure 1 | 25°C       | 30                  | 40  |      | 30        | 40   |     | V/ $\mu\text{s}$       |
|   |   | Full range | 24                  |     |      | 24        |      |     |                        |
| SR- Negative slew rate                                  |   | 25°C       | 30                  | 45  |      | 30        | 45   |     | V/ $\mu\text{s}$       |
|   |   | Full range | 24                  |     |      | 24        |      |     |                        |
| $t_s$ Settling time                                     | $A_{VD} = -1$ ,<br>10-V step,<br>$R_L = 1\text{ k}\Omega$ ,<br>$C_L = 100\text{ pF}$  | 25°C       | To 10 mV            |     | 0.4  |           | 0.4  |     | $\mu\text{s}$          |
|   |   |            | To 1 mV             |     | 1.5  |           | 1.5  |     |                        |
| $V_n$ Equivalent input noise voltage                    | $R_S = 20\ \Omega$ ,<br>See Figure 3  | 25°C       | f = 10 Hz           |     | 28   |           | 28   |     | nV/ $\sqrt{\text{Hz}}$ |
|   |   |            | f = 10 kHz          |     | 11.6 |           | 11.6 |     |                        |
| $V_{N(PP)}$ Peak-to-peak equivalent input noise voltage |   | 25°C       | f = 10 Hz to 10 kHz |     | 6    |           | 6    |     | $\mu\text{V}$          |
|   |   |            | f = 0.1 Hz to 10 Hz |     | 0.6  |           | 0.6  |     |                        |
| $I_n$ Equivalent input noise current                    | $V_{IC} = 0$ , f = 10 kHz   | 25°C       | 2.8                 |     |      | 2.8       |      |     | fA/ $\sqrt{\text{Hz}}$ |
| THD + N Total harmonic distortion plus noise            | $V_{O(PP)} = 20\text{ V}$ , $A_{VD} = 10$ ,<br>f = 1 kHz, $R_L = 2\text{ k}\Omega$ ,<br>$R_S = 25\ \Omega$                  | 25°C       | 0.008%              |     |      | 0.008%    |      |     |                        |
| $B_1$ Unity-gain bandwidth                              | $V_I = 10\text{ mV}$ , $R_L = 2\text{ k}\Omega$ ,<br>$C_L = 25\text{ pF}$ , See Figure 2                                    | 25°C       | 8                   | 10  |      | 8         | 10   | MHz |                        |
| BOM Maximum output-swing bandwidth                      | $V_{O(PP)} = 20\text{ V}$ , $A_{VD} = -1$ ,<br>$R_L = 2\text{ k}\Omega$ , $C_L = 25\text{ pF}$                              | 25°C       | 478                 | 637 |      | 478       | 637  | kHz |                        |
| $\phi_m$ Phase margin at unity gain                     | $V_I = 10\text{ mV}$ , $R_L = 2\text{ k}\Omega$ ,<br>$C_L = 25\text{ pF}$ , See Figure 2                                    | 25°C       | 57°                 |     |      | 57°       |      |     |                        |

† Full range is  $-40^\circ\text{C}$  to  $85^\circ\text{C}$ .



**TLE208x, TLE208xA, TLE208xY**  
**EXCALIBUR HIGH-SPEED JFET-INPUT**  
**OPERATIONAL AMPLIFIERS**

SLOS182B – FEBRUARY 1997 – REVISED JUNE 2001

**TLE2081M electrical characteristics at specified free-air temperature,  $V_{CC\pm} = \pm 5$  V (unless otherwise noted)**

| PARAMETER   | TEST CONDITIONS  | $T_A$ †               | TLE2081M   |           |      | TLE2081AM |           |                  | UNIT     |    |
|---|--|-----------------------|------------|-----------|------|-----------|-----------|------------------|----------|----|
|   |  |                       | MIN        | TYP       | MAX  | MIN       | TYP       | MAX              |          |    |
| $V_{IO}$ Input offset voltage   | $V_{IC} = 0,$<br>$V_O = 0,$<br>$R_S = 50\Omega$                        | 25°C                  | 0.34       | 6         |      | 0.3       | 3         | mV               |          |    |
|   |  | Full range            |            |           | 11.2 |           | 8.2       |                  |          |    |
| $\alpha V_{IO}$ Temperature coefficient of input offset voltage               |  | Full range            | 3.2        | 29*       |      | 3.2       | 29*       | $\mu V/^\circ C$ |          |    |
| $I_{IO}$ Input offset current   | $V_{IC} = 0,$<br>$V_O = 0,$<br>See Figure 4                            | 25°C                  | 5          | 100       |      | 5         | 100       | pA               |          |    |
|   |  | Full range            |            |           | 20   |           | 20        | nA               |          |    |
| $I_{IB}$ Input bias current   |  | 25°C                  | 15         | 175       |      | 15        | 175       | pA               |          |    |
|   |  | Full range            |            |           | 65   |           | 65        | nA               |          |    |
| $V_{ICR}$ Common-mode input voltage range                                     | $R_S = 50\Omega$   | 25°C                  | 5 to -1    | 5 to -1.9 |      | 5 to -1   | 5 to -1.9 | V                |          |    |
|   |  | Full range            | 5 to -0.8  |           |      | 5 to -0.8 |           |                  |          |    |
| $V_{OM+}$ Maximum positive peak output voltage swing                          | $I_O = -200\mu A$  | 25°C                  | 3.8        | 4.1       |      | 3.8       | 4.1       | V                |          |    |
|   |  | Full range            | 3.6        |           |      | 3.6       |           |                  |          |    |
|   | $I_O = -2$ mA  | 25°C                  | 3.5        | 3.9       |      | 3.5       | 3.9       |                  |          |    |
|   |  | Full range            | 3.3        |           |      | 3.3       |           |                  |          |    |
|   | $I_O = -20$ mA   | 25°C                  | 1.5        | 2.3       |      | 1.5       | 2.3       |                  |          |    |
|   |  | Full range            | 1.4        |           |      | 1.4       |           |                  |          |    |
| $V_{OM-}$ Maximum negative peak output voltage swing                          | $I_O = 200\mu A$   | 25°C                  | -3.8       | -4.2      |      | -3.8      | -4.2      | V                |          |    |
|   |  | Full range            | -3.6       |           |      | -3.6      |           |                  |          |    |
|   | $I_O = 2$ mA   | 25°C                  | -3.5       | -4.1      |      | -3.5      | -4.1      |                  |          |    |
|   |  | Full range            | -3.3       |           |      | -3.3      |           |                  |          |    |
|   | $I_O = 20$ mA  | 25°C                  | -1.5       | -2.4      |      | -1.5      | -2.4      |                  |          |    |
|   |  | Full range            | -1.4       |           |      | -1.4      |           |                  |          |    |
| $A_{VD}$ Large-signal differential voltage amplification                      | $V_O = \pm 2.3$ V  | $R_L = 600\Omega$     | 25°C       | 80        | 91   |           | 80        | 91               | dB       |    |
|   |  |                       | Full range | 78        |      |           | 78        |                  |          |    |
|   |  | $R_L = 2$ k $\Omega$  | 25°C       | 90        | 100  |           | 90        | 100              |          |    |
|   |  |                       | Full range | 88        |      |           | 88        |                  |          |    |
|   |  | $R_L = 10$ k $\Omega$ | 25°C       | 95        | 106  |           | 95        | 106              |          |    |
|   |  |                       | Full range | 93        |      |           | 93        |                  |          |    |
| $r_i$ Input resistance  | $V_{IC} = 0$   | 25°C                  | $10^{12}$  |           |      | $10^{12}$ |           |                  | $\Omega$ |    |
| $c_i$ Input capacitance   | $V_{IC} = 0,$<br>See Figure 5  | Common mode           | 25°C       | 11        |      |           | 11        |                  |          | pF |
|   |  | Differential          | 25°C       | 2.5       |      |           | 2.5       |                  |          |    |
| $z_o$ Open-loop output impedance  | $f = 1$ MHz  | 25°C                  | 80         |           |      | 80        |           |                  | $\Omega$ |    |
| CMRR Common-mode rejection ratio  | $V_{IC} = V_{ICRmin},$<br>$V_O = 0,$<br>$R_S = 50\Omega$               | 25°C                  | 70         | 89        |      | 70        | 89        | dB               |          |    |
|   |  | Full range            | 68         |           |      | 68        |           |                  |          |    |
| $k_{SVR}$ Supply-voltage rejection ratio ( $\Delta V_{CC\pm}/\Delta V_{IO}$ ) | $V_{CC\pm} = \pm 5$ V to $\pm 15$ V,<br>$V_O = 0,$<br>$R_S = 50\Omega$ | 25°C                  | 82         | 99        |      | 82        | 99        | dB               |          |    |
|   |  | Full range            | 80         |           |      | 80        |           |                  |          |    |

\*On products compliant with MIL-PRF-38535, Class B, this parameter is not production tested.

† Full range is  $-55^\circ C$  to  $125^\circ C$ .



**TLE208x, TLE208xA, TLE208xY**  
**EXCALIBUR HIGH-SPEED JFET-INPUT**  
**OPERATIONAL AMPLIFIERS**

SLOS182B – FEBRUARY 1997 – REVISED JUNE 2001

**TLE2081M electrical characteristics at specified free-air temperature,  $V_{CC\pm} = \pm 5\text{ V}$  (unless otherwise noted) (continued)**

| PARAMETER | TEST CONDITIONS              | $T_A$ †             | TLE2081M               |      |     | TLE2081AM |      |     | UNIT |    |
|-----------|------------------------------|---------------------|------------------------|------|-----|-----------|------|-----|------|----|
|           |                              |                     | MIN                    | TYP  | MAX | MIN       | TYP  | MAX |      |    |
| $I_{CC}$  | Supply current               | $V_O = 0$ , No load | 25°C                   | 1.35 | 1.6 | 2.2       | 1.35 | 1.6 | 2.2  | mA |
|           |                              |                     | Full range             | 2.2  |     |           | 2.2  |     |      |    |
| $I_{OS}$  | Short-circuit output current | $V_O = 0$           | $V_{ID} = 1\text{ V}$  | -35  |     |           | -35  |     |      | mA |
|           |                              |                     | $V_{ID} = -1\text{ V}$ | 45   |     |           | 45   |     |      |    |

† Full range is  $-55^\circ\text{C}$  to  $125^\circ\text{C}$ .

**TLE2081M operating characteristics at specified free-air temperature,  $V_{CC\pm} = \pm 5\text{ V}$**

| PARAMETER   | TEST CONDITIONS                             | $T_A$ †  | TLE2081M            |        |     | TLE2081AM |        |     | UNIT |                              |
|-------------|---|--|---------------------|--------|-----|-----------|--------|-----|------|------------------------------|
|             |   |  | MIN                 | TYP    | MAX | MIN       | TYP    | MAX |      |                              |
| $SR_+$      | Positive slew rate                          | $V_{O(PP)} = \pm 2.3\text{ V}$ ,<br>$A_{VD} = -1$ ,<br>$R_L = 2\text{ k}\Omega$ ,<br>$C_L = 100\text{ pF}$ ,<br>See Figure 1 | 25°C                | 35     |     |           | 35     |     |      | $\text{V}/\mu\text{s}$       |
|             |   |  | Full range          | 20*    |     |           | 20*    |     |      |                              |
| $SR_-$      | Negative slew rate                          | $V_{O(PP)} = \pm 2.3\text{ V}$ ,<br>$A_{VD} = -1$ ,<br>$R_L = 2\text{ k}\Omega$ ,<br>$C_L = 100\text{ pF}$ ,<br>See Figure 1 | 25°C                | 38     |     |           | 38     |     |      | $\text{V}/\mu\text{s}$       |
|             |   |  | Full range          | 20*    |     |           | 20*    |     |      |                              |
| $t_s$       | Settling time                               | $A_{VD} = -1$ ,<br>2-V step,<br>$R_L = 1\text{ k}\Omega$ ,<br>$C_L = 100\text{ pF}$  | To 10 mV            | 0.25   |     |           | 0.25   |     |      | $\mu\text{s}$                |
|             |   |  | To 1 mV             | 0.4    |     |           | 0.4    |     |      |                              |
| $V_n$       | Equivalent input noise voltage              | $R_S = 20\ \Omega$ ,<br>See Figure 3   | f = 10 Hz           | 28     |     |           | 28     |     |      | $\text{nV}/\sqrt{\text{Hz}}$ |
|             |   |  | f = 10 kHz          | 11.6   |     |           | 11.6   |     |      |                              |
| $V_{N(PP)}$ | Peak-to-peak equivalent input noise voltage | $R_S = 20\ \Omega$ ,<br>See Figure 3   | f = 10 Hz to 10 kHz | 6      |     |           | 6      |     |      | $\mu\text{V}$                |
|             |   |  | f = 0.1 Hz to 10 Hz | 0.6    |     |           | 0.6    |     |      |                              |
| $I_n$       | Equivalent input noise current              | $V_{IC} = 0$ , f = 10 kHz  | 25°C                | 2.8    |     |           | 2.8    |     |      | $\text{fA}/\sqrt{\text{Hz}}$ |
| THD + N     | Total harmonic distortion plus noise        | $V_{O(PP)} = 5\text{ V}$ ,<br>f = 1 kHz,<br>$R_S = 25\ \Omega$   | 25°C                | 0.013% |     |           | 0.013% |     |      |                              |
| $B_1$       | Unity-gain bandwidth                        | $V_I = 10\text{ mV}$ ,<br>$C_L = 25\text{ pF}$ ,<br>$R_L = 2\text{ k}\Omega$ ,<br>See Figure 2                               | 25°C                | 9.4    |     |           | 9.4    |     |      | MHz                          |
| $B_{OM}$    | Maximum output-swing bandwidth              | $V_{O(PP)} = 4\text{ V}$ ,<br>$R_L = 2\text{ k}\Omega$ ,<br>$C_L = 25\text{ pF}$   | 25°C                | 2.8    |     |           | 2.8    |     |      | MHz                          |
| $\phi_m$    | Phase margin at unity gain                  | $V_I = 10\text{ mV}$ ,<br>$C_L = 25\text{ pF}$ ,<br>$R_L = 2\text{ k}\Omega$ ,<br>See Figure 2                               | 25°C                | 56°    |     |           | 56°    |     |      |                              |

\*On products compliant with MIL-PRF-38535, Class B, this parameter is not production tested.

† Full range is  $-55^\circ\text{C}$  to  $125^\circ\text{C}$ .



**TLE208x, TLE208xA, TLE208xY**  
**EXCALIBUR HIGH-SPEED JFET-INPUT**  
**OPERATIONAL AMPLIFIERS**

SLOS182B – FEBRUARY 1997 – REVISED JUNE 2001

**TLE2081M electrical characteristics at specified free-air temperature,  $V_{CC\pm} = \pm 15$  V (unless otherwise noted)**

| PARAMETER   | TEST CONDITIONS   | $T_A$ †               | TLE2081M   |             |             | TLE2081AM |             |                  | UNIT |
|---|---|-----------------------|------------|-------------|-------------|-----------|-------------|------------------|------|
|   |   |                       | MIN        | TYP         | MAX         | MIN       | TYP         | MAX              |      |
| $V_{IO}$ Input offset voltage   | $V_{IC} = 0,$<br>$R_S = 50 \Omega$                                      | $V_O = 0,$            | 25°C       | 0.49        | 6           | 0.47      | 3           | mV               |      |
|   |   |                       | Full range | 11.2        |             |           | 8.2         |                  |      |
| $\alpha_{VIO}$ Temperature coefficient of input offset voltage                  | $V_{IC} = 0,$<br>$R_S = 50 \Omega$                                      | $V_O = 0,$            | 25°C       | 3.2         | 29*         | 3.2       | 29*         | $\mu V/^\circ C$ |      |
| Full range  |   |                       | 11.2       |             |             | 8.2       |             |                  |      |
| $I_{IO}$ Input offset current   | $V_{IC} = 0,$<br>See Figure 4   | $V_O = 0,$            | 25°C       | 6           | 100         | 6         | 100         | pA               |      |
| Full range  |   |                       | 20         |             |             | 20        |             |                  |      |
| $I_{IB}$ Input bias current   | $V_{IC} = 0,$<br>See Figure 4   | $V_O = 0,$            | 25°C       | 20          | 175         | 20        | 175         | pA               |      |
|   |   |                       | Full range | 65          |             |           | 65          |                  |      |
| $V_{ICR}$ Common-mode input voltage range                                       | $R_S = 50 \Omega$   |                       | 25°C       | 15 to -11   | 15 to -11.9 | 15 to -11 | 15 to -11.9 | V                |      |
|   |   |                       | Full range | 15 to -10.8 |             |           | 15 to -10.8 |                  |      |
| $V_{OM+}$ Maximum positive peak output voltage swing                            | $I_O = -200 \mu A$  |                       | 25°C       | 13.8        | 14.1        | 13.8      | 14.1        | V                |      |
|   |   |                       | Full range | 13.6        |             |           | 13.6        |                  |      |
|   | $I_O = -2$ mA   |                       | 25°C       | 13.5        | 13.9        | 13.5      | 13.9        |                  |      |
|   |   |                       | Full range | 13.3        |             |           | 13.3        |                  |      |
|   | $I_O = -20$ mA  |                       | 25°C       | 11.5        | 12.3        | 11.5      | 12.3        |                  |      |
|   |   |                       | Full range | 11.4        |             |           | 11.4        |                  |      |
| $V_{OM-}$ Maximum negative peak output voltage swing                            | $I_O = 200 \mu A$   |                       | 25°C       | -13.8       | -14.2       | -13.8     | -14.2       | V                |      |
|   |   |                       | Full range | -13.6       |             |           | -13.6       |                  |      |
|   | $I_O = 2$ mA  |                       | 25°C       | -13.5       | -14         | -13.5     | -14         |                  |      |
|   |   |                       | Full range | -13.3       |             |           | -13.3       |                  |      |
|   | $I_O = 20$ mA   |                       | 25°C       | -11.5       | -12.4       | -11.5     | -12.4       |                  |      |
|   |   |                       | Full range | -11.4       |             |           | -11.4       |                  |      |
| $A_{VD}$ Large-signal differential voltage amplification                        | $V_O = \pm 10$ V  | $R_L = 600 \Omega$    | 25°C       | 80          | 96          | 80        | 96          | dB               |      |
|   |   |                       | Full range | 78          |             |           | 78          |                  |      |
|   |   | $R_L = 2$ k $\Omega$  | 25°C       | 90          | 109         | 90        | 109         |                  |      |
|   |   |                       | Full range | 88          |             |           | 88          |                  |      |
|   |   | $R_L = 10$ k $\Omega$ | 25°C       | 95          | 118         | 95        | 118         |                  |      |
|   |   |                       | Full range | 93          |             |           | 93          |                  |      |
| $r_i$ Input resistance  | $V_{IC} = 0$  |                       | 25°C       | $10^{12}$   |             |           | $10^{12}$   | $\Omega$         |      |
| $c_i$ Input capacitance   | $V_{IC} = 0,$<br>See Figure 5   | Common mode           | 25°C       | 7.5         |             |           | 7.5         | pF               |      |
|   |   | Differential          | 25°C       | 2.5         |             |           | 2.5         |                  |      |
| $z_o$ Open-loop output impedance  | $f = 1$ MHz   |                       | 25°C       | 80          |             |           | 80          | $\Omega$         |      |
| CMRR Common-mode rejection ratio  | $V_{IC} = V_{ICRmin},$<br>$V_O = 0,$<br>$R_S = 50 \Omega$               |                       | 25°C       | 80          | 98          | 80        | 98          | dB               |      |
|   |   |                       | Full range | 78          |             |           | 78          |                  |      |
| $k_{SVR}$ Supply-voltage rejection ratio ( $\Delta V_{CC\pm} / \Delta V_{IO}$ ) | $V_{CC\pm} = \pm 5$ V to $\pm 15$ V,<br>$V_O = 0,$<br>$R_S = 50 \Omega$ |                       | 25°C       | 82          | 99          | 82        | 99          | dB               |      |
|   |   |                       | Full range | 80          |             |           | 80          |                  |      |

\*On products compliant with MIL-PRF-38535, Class B, this parameter is not production tested.

† Full range is  $-55^\circ C$  to  $125^\circ C$ .



# TLE208x, TLE208xA, TLE208xY EXCALIBUR HIGH-SPEED JFET-INPUT OPERATIONAL AMPLIFIERS

SLOS182B – FEBRUARY 1997 – REVISED JUNE 2001

**TLE2081M electrical characteristics at specified free-air temperature,  $V_{CC\pm} = \pm 15\text{ V}$  (unless otherwise noted)(continued)**

| PARAMETER | TEST CONDITIONS              | $T_A$ †                | TLE2081M   |                        |     | TLE2081AM |      |     | UNIT |    |
|-----------|------------------------------|------------------------|------------|------------------------|-----|-----------|------|-----|------|----|
|           |                              |                        | MIN        | TYP                    | MAX | MIN       | TYP  | MAX |      |    |
| $I_{CC}$  | Supply current               | $V_O = 0$ ,<br>No load | 25°C       | 1.35                   | 1.7 | 2.2       | 1.35 | 1.7 | 2.2  | mA |
|           |                              |                        | Full range | 2.2                    |     |           | 2.2  |     |      |    |
| $I_{OS}$  | Short-circuit output current | $V_O = 0$              | 25°C       | $V_{ID} = 1\text{ V}$  | -30 | -45       | -30  | -45 | mA   |    |
|           |                              |                        |            | $V_{ID} = -1\text{ V}$ | 30  | 48        | 30   | 48  |      |    |

† Full range is  $-55^\circ\text{C}$  to  $125^\circ\text{C}$ .

**TLE2081M operating characteristics at specified free-air temperature,  $V_{CC\pm} = \pm 15\text{ V}$**

| PARAMETER   | TEST CONDITIONS                             | $T_A$ †   | TLE2081M   |                     |      | TLE2081AM |      |                              | UNIT                         |
|-------------|---|---|------------|---------------------|------|-----------|------|------------------------------|------------------------------|
|             |   |   | MIN        | TYP                 | MAX  | MIN       | TYP  | MAX                          |                              |
| SR+         | Positive slew rate                          | $V_{O(PP)} = 10\text{ V}$ ,<br>$A_{VD} = -1$ ,<br>$C_L = 100\text{ pF}$ ,<br>$R_L = 2\text{ k}\Omega$ ,<br>See Figure 1 | 25°C       | 30                  | 40   | 30        | 40   | $\text{V}/\mu\text{s}$       |                              |
|             |   |   | Full range | 22                  |      |           | 22   |                              |                              |
| SR-         | Negative slew rate                          |   | 25°C       | 30                  | 45   | 30        | 45   | $\text{V}/\mu\text{s}$       |                              |
|             |   |   | Full range | 22                  |      |           | 22   |                              |                              |
| $t_s$       | Settling time                               | $A_{VD} = -1$ ,<br>10-V step,<br>$R_L = 1\text{ k}\Omega$ ,<br>$C_L = 100\text{ pF}$                                    | 25°C       | To 10 mV            | 0.4  |           | 0.4  |                              | $\mu\text{s}$                |
|             |   |   |            | To 1 mV             | 1.5  |           | 1.5  |                              |                              |
| $V_n$       | Equivalent input noise voltage              |   | 25°C       | f = 10 Hz           | 28   |           | 28   |                              | $\text{nV}/\sqrt{\text{Hz}}$ |
|             |   |   |            | f = 10 kHz          | 11.6 |           | 11.6 |                              |                              |
| $V_{N(PP)}$ | Peak-to-peak equivalent input noise voltage | $R_S = 20\ \Omega$ ,<br>See Figure 3  | 25°C       | f = 10 Hz to 10 kHz | 6    |           | 6    |                              | $\mu\text{V}$                |
|             |   |   |            | f = 0.1 Hz to 10 Hz | 0.6  |           | 0.6  |                              |                              |
| $I_n$       | Equivalent input noise current              | $V_{IC} = 0$ ,<br>f = 10 kHz  | 25°C       | 2.8                 |      | 2.8       |      | $\text{fA}/\sqrt{\text{Hz}}$ |                              |
| THD + N     | Total harmonic distortion plus noise        | $V_{O(PP)} = 20\text{ V}$ ,<br>f = 1 kHz,<br>$R_S = 25\ \Omega$   | 25°C       | 0.008%              |      | 0.008%    |      |                              |                              |
| $B_1$       | Unity-gain bandwidth                        | $V_I = 10\text{ mV}$ ,<br>$C_L = 25\text{ pF}$ ,<br>$R_L = 2\text{ k}\Omega$ ,<br>See Figure 2                          | 25°C       | 8*                  | 10   | 8*        | 10   | MHz                          |                              |
| BOM         | Maximum output-swing bandwidth              | $V_{O(PP)} = 20\text{ V}$ ,<br>$R_L = 2\text{ k}\Omega$ ,<br>$C_L = 25\text{ pF}$                                       | 25°C       | 478*                | 637  | 478*      | 637  | kHz                          |                              |
| $\phi_m$    | Phase margin at unity gain                  | $V_I = 10\text{ mV}$ ,<br>$C_L = 25\text{ pF}$ ,<br>$R_L = 2\text{ k}\Omega$ ,<br>See Figure 2                          | 25°C       | 57°                 |      | 57°       |      |                              |                              |

\*On products compliant with MIL-PRF-38535, Class B, this parameter is not production tested.

† Full range is  $-55^\circ\text{C}$  to  $125^\circ\text{C}$ .



**TLE208x, TLE208xA, TLE208xY**  
**EXCALIBUR HIGH-SPEED JFET-INPUT**  
**OPERATIONAL AMPLIFIERS**

SLOS182B – FEBRUARY 1997 – REVISED JUNE 2001

**TLE2081Y electrical characteristics at  $V_{CC\pm} = \pm 15\text{ V}$ ,  $T_A = 25^\circ\text{C}$**

| PARAMETER |   | TEST CONDITIONS  |                                | TLE2081Y         |                  |     | UNIT     |
|-----------|---|--|--------------------------------|------------------|------------------|-----|----------|
|           |   |  |                                | MIN              | TYP              | MAX |          |
| $V_{IO}$  | Input offset voltage  | $V_{IC} = 0$ ,   | $V_O = 0$ , $R_S = 50\ \Omega$ | 0.49             | 6                |     | mV       |
| $I_{IO}$  | Input offset current  | $V_{IC} = 0$ ,   | $V_O = 0$ , See Figure 4       | 6                | 100              |     | pA       |
| $I_{IB}$  | Input bias current  |  |                                | 20               | 175              |     |          |
| $V_{ICR}$ | Common-mode input voltage range                                       | $R_S = 50\ \Omega$   |                                | 15<br>to<br>-11  | 15<br>to<br>11.9 |     | V        |
| $V_{OM+}$ | Maximum positive peak output voltage swing                            | $I_O = -200\ \mu\text{A}$  |                                | 13.8             | 14.1             |     | V        |
|           |   | $I_O = -2\ \text{mA}$  |                                | 13.5             | 13.9             |     |          |
|           |   | $I_O = -20\ \text{mA}$   |                                | 11.5             | 12.3             |     |          |
| $V_{OM-}$ | Maximum negative peak output voltage swing                            | $I_O = 200\ \mu\text{A}$   |                                | -13.8            | -14.2            |     | V        |
|           |   | $I_O = 2\ \text{mA}$   |                                | -13.5            | -14              |     |          |
|           |   | $I_O = 20\ \text{mA}$  |                                | -11.5            | -12.4            |     |          |
| $A_{VD}$  | Large-signal differential voltage amplification                       | $V_O = \pm 10\ \text{V}$   | $R_L = 600\ \Omega$            | 80               | 96               |     | dB       |
|           |   |  | $R_L = 2\ \text{k}\Omega$      | 90               | 109              |     |          |
|           |   |  | $R_L = 10\ \text{k}\Omega$     | 95               | 118              |     |          |
| $r_i$     | Input resistance  | $V_{IC} = 0$   |                                | 10 <sup>12</sup> |                  |     | $\Omega$ |
| $c_i$     | Input capacitance   | $V_{IC} = 0$ , See Figure 5  | Common mode                    | 7.5              |                  |     | pF       |
|           |   |  | Differential                   | 2.5              |                  |     |          |
| $z_o$     | Open-loop output impedance  | $f = 1\ \text{MHz}$  |                                | 80               |                  |     | $\Omega$ |
| CMRR      | Common-mode rejection ratio   | $V_{IC} = V_{ICR\text{min}}$ ,   | $V_O = 0$ , $R_S = 50\ \Omega$ | 80               | 98               |     | dB       |
| $k_{SVR}$ | Supply-voltage rejection ratio ( $\Delta V_{CC\pm} / \Delta V_{IO}$ ) | $V_{CC\pm} = \pm 5\ \text{V}$ to $\pm 15\ \text{V}$ , $V_O = 0$ , $R_S = 50\ \Omega$ |                                | 82               | 99               |     | dB       |
| $I_{CC}$  | Supply current  | $V_O = 0$ ,  | No load                        | 1.35             | 1.7              | 2.2 | mA       |
| $I_{OS}$  | Short-circuit output current  | $V_O = 0$  | $V_{ID} = 1\ \text{V}$         | -30              | -45              |     | mA       |
|           |   |  | $V_{ID} = -1\ \text{V}$        | 30               | 48               |     |          |

# TLE208x, TLE208xA, TLE208xY EXCALIBUR HIGH-SPEED JFET-INPUT OPERATIONAL AMPLIFIERS

SLOS182B – FEBRUARY 1997 – REVISED JUNE 2001

**TLE2082C electrical characteristics at specified free-air temperature,  $V_{CC\pm} = \pm 5$  V (unless otherwise noted)**

| PARAMETER   | TEST CONDITIONS  | $T_A$ †                           | TLE2082C   |           |      | TLE2082AC |           |                  | UNIT     |    |
|---|--|-----------------------------------|------------|-----------|------|-----------|-----------|------------------|----------|----|
|   |  |                                   | MIN        | TYP       | MAX  | MIN       | TYP       | MAX              |          |    |
| $V_{IO}$ Input offset voltage   | $V_{IC} = 0, V_O = 0, R_S = 50 \Omega$                                       | 25°C                              | 0.9        | 6         |      | 0.65      | 4         | mV               |          |    |
|   |  | Full range                        |            |           | 8.1  |           | 5.1       |                  |          |    |
| $\alpha_{VIO}$ Temperature coefficient of input offset voltage                  |  | Full range                        | 2.3        | 25        |      | 2.3       | 25        | $\mu V/^\circ C$ |          |    |
| $I_{IO}$ Input offset current   | $V_{IC} = 0, V_O = 0, \text{See Figure 4}$                                   | 25°C                              | 5          | 100       |      | 5         | 100       | pA               |          |    |
|   |  | Full range                        |            |           | 1.4  |           | 1.4       | nA               |          |    |
| $I_{IB}$ Input bias current   |  | 25°C                              | 15         | 175       |      | 15        | 175       | pA               |          |    |
|   |  | Full range                        |            |           | 5    |           | 5         | nA               |          |    |
| $V_{ICR}$ Common-mode input voltage range                                       | $R_S = 50 \Omega$  | 25°C                              | 5 to -1    | 5 to -1.9 |      | 5 to -1   | 5 to -1.9 | V                |          |    |
|   |  | Full range                        | 5 to -0.9  |           |      | 5 to -0.9 |           |                  |          |    |
| $V_{OM+}$ Maximum positive peak output voltage swing                            | $I_O = -200 \mu A$   | 25°C                              | 3.8        | 4.1       |      | 3.8       | 4.1       | V                |          |    |
|   |  | Full range                        | 3.7        |           |      | 3.7       |           |                  |          |    |
|   | $I_O = -2 \text{ mA}$  | 25°C                              | 3.5        | 3.9       |      | 3.5       | 3.9       |                  |          |    |
|   |  | Full range                        | 3.4        |           |      | 3.4       |           |                  |          |    |
| $I_O = -20 \text{ mA}$  | 25°C   | 1.5                               | 2.3        |           | 1.5  | 2.3       |           |                  |          |    |
|   | Full range   | 1.5                               |            |           | 1.5  |           |           |                  |          |    |
| $V_{OM-}$ Maximum negative peak output voltage swing                            | $I_O = 200 \mu A$  | 25°C                              | -3.8       | -4.2      |      | -3.8      | -4.2      | V                |          |    |
|   |  | Full range                        | -3.7       |           |      | -3.7      |           |                  |          |    |
|   | $I_O = 2 \text{ mA}$   | 25°C                              | -3.5       | -4.1      |      | -3.5      | -4.1      |                  |          |    |
|   |  | Full range                        | -3.4       |           |      | -3.4      |           |                  |          |    |
| $I_O = 20 \text{ mA}$   | 25°C   | -1.5                              | -2.4       |           | -1.5 | -2.4      |           |                  |          |    |
|   | Full range   | -1.5                              |            |           | -1.5 |           |           |                  |          |    |
| $A_{VD}$ Large-signal differential voltage amplification                        | $V_O = \pm 2.3 \text{ V}$  | $R_L = 600 \Omega$                | 25°C       | 80        | 91   |           | 80        | 91               | dB       |    |
|   |  |                                   | Full range | 79        |      |           | 79        |                  |          |    |
|   |  | $R_L = 2 \text{ k}\Omega$         | 25°C       | 90        | 100  |           | 90        | 100              |          |    |
|   |  |                                   | Full range | 89        |      |           | 89        |                  |          |    |
|   |  | $R_L = 10 \text{ k}\Omega$        | 25°C       | 95        | 106  |           | 95        | 106              |          |    |
|   |  |                                   | Full range | 94        |      |           | 94        |                  |          |    |
| $r_i$ Input resistance  | $V_{IC} = 0$   | 25°C                              | $10^{12}$  |           |      | $10^{12}$ |           |                  | $\Omega$ |    |
| $c_i$ Input capacitance   | Common mode  | $V_{IC} = 0, \text{See Figure 5}$ | 25°C       | 11        |      |           | 11        |                  |          | pF |
|   | Differential   |                                   | 25°C       | 2.5       |      |           | 2.5       |                  |          |    |
| $z_o$ Open-loop output impedance  | $f = 1 \text{ MHz}$  | 25°C                              | 80         |           |      | 80        |           |                  | $\Omega$ |    |
| CMRR Common-mode rejection ratio  | $V_{IC} = V_{ICRmin}, V_O = 0, R_S = 50 \Omega$                              | 25°C                              | 70         | 89        |      | 70        | 89        | dB               |          |    |
|   |  | Full range                        | 68         |           |      | 68        |           |                  |          |    |
| $k_{SVR}$ Supply-voltage rejection ratio ( $\Delta V_{CC\pm} / \Delta V_{IO}$ ) | $V_{CC\pm} = \pm 5 \text{ V to } \pm 15 \text{ V}, V_O = 0, R_S = 50 \Omega$ | 25°C                              | 82         | 99        |      | 82        | 99        | dB               |          |    |
|   |  | Full range                        | 80         |           |      | 80        |           |                  |          |    |
| $I_{CC}$ Supply current (both channels)   | $V_O = 0, \text{No load}$  | 25°C                              | 2.7        | 2.9       | 3.9  | 2.7       | 2.9       | 3.9              | mA       |    |
|   |  | Full range                        |            |           | 3.9  |           |           | 3.9              |          |    |

† Full range is 0°C to 70°C.



**TLE208x, TLE208xA, TLE208xY**  
**EXCALIBUR HIGH-SPEED JFET-INPUT**  
**OPERATIONAL AMPLIFIERS**

SLOS182B – FEBRUARY 1997 – REVISED JUNE 2001

**TLE2082C electrical characteristics at specified free-air temperature,  $V_{CC\pm} = \pm 5$  V (unless otherwise noted) (continued)**

| PARAMETER                             | TEST CONDITIONS                     | $T_A$ | TLE2082C        |     |     | TLE2082AC |     |     | UNIT |
|---------------------------------------|-------------------------------------|-------|-----------------|-----|-----|-----------|-----|-----|------|
|                                       |                                     |       | MIN             | TYP | MAX | MIN       | TYP | MAX |      |
| Crosstalk attenuation                 | $V_{IC} = 0$ , $R_L = 2$ k $\Omega$ | 25°C  | 120             |     |     | 120       |     |     | dB   |
| $I_{OS}$ Short-circuit output current | $V_O = 0$                           | 25°C  | $V_{ID} = 1$ V  |     |     | -35       |     |     | mA   |
|                                       |                                     |       | $V_{ID} = -1$ V |     |     | 45        |     |     |      |

**TLE2082C operating characteristics at specified free-air temperature,  $V_{CC\pm} = \pm 5$  V**

| PARAMETER   | TEST CONDITIONS  | $T_A$ †                                   | TLE2082C |        |     | TLE2082AC |        |     | UNIT            |     |
|---|--|---|----------|--------|-----|-----------|--------|-----|-----------------|-----|
|   |  |   | MIN      | TYP    | MAX | MIN       | TYP    | MAX |                 |     |
| SR+ Positive slew rate                                  | $V_{O(PP)} = \pm 2.3$ V,<br>$A_{VD} = -1$ ,<br>$C_L = 100$ pF,<br>$R_L = 2$ k $\Omega$ ,<br>See Figure 1 | 25°C                                      | 35       |        |     | 35        |        |     | V/ $\mu$ s      |     |
|   |  | Full range                                | 22       |        |     | 22        |        |     |                 |     |
| SR- Negative slew rate                                  |  | 25°C                                      | 38       |        |     | 38        |        |     | V/ $\mu$ s      |     |
|   |  | Full range                                | 22       |        |     | 22        |        |     |                 |     |
| $t_s$ Settling time                                     | $A_{VD} = -1$ ,<br>2-V step,<br>$R_L = 1$ k $\Omega$ ,<br>$C_L = 100$ pF                                 | To 10 mV                                  | 0.25     |        |     | 0.25      |        |     | $\mu$ s         |     |
|   |  | To 1 mV                                   | 0.4      |        |     | 0.4       |        |     |                 |     |
| $V_n$ Equivalent input noise voltage                    | $R_S = 20$ $\Omega$ ,<br>See Figure 3  | f = 10 Hz                                 | 28       |        |     | 28        |        |     | nV/ $\sqrt{Hz}$ |     |
|   |  | f = 10 kHz                                | 11.6     |        |     | 11.6      |        |     |                 |     |
| $V_{N(PP)}$ Peak-to-peak equivalent input noise voltage |  | f = 10 Hz to 10 kHz                       | 6        |        |     | 6         |        |     | $\mu$ V         |     |
|   |  | f = 0.1 Hz to 10 Hz                       | 0.6      |        |     | 0.6       |        |     |                 |     |
| $I_n$ Equivalent input noise current                    | $V_{IC} = 0$ , f = 10 kHz  | 25°C                                      | 2.8      |        |     | 2.8       |        |     | fA/ $\sqrt{Hz}$ |     |
| THD + N Total harmonic distortion plus noise            | $V_{O(PP)} = 5$ V,<br>f = 1 kHz,<br>$R_S = 25$ $\Omega$  | $A_{VD} = 10$ ,<br>$R_L = 2$ k $\Omega$ , | 25°C     | 0.013% |     |           | 0.013% |     |                 |     |
| $B_1$ Unity-gain bandwidth                              | $V_I = 10$ mV,<br>$C_L = 25$ pF,   | $R_L = 2$ k $\Omega$ ,<br>See Figure 2    | 25°C     | 9.4    |     |           | 9.4    |     |                 | MHz |
| $B_{OM}$ Maximum output-swing bandwidth                 | $V_{O(PP)} = 4$ V,<br>$R_L = 2$ k $\Omega$ ,   | $A_{VD} = -1$ ,<br>$C_L = 25$ pF          | 25°C     | 2.8    |     |           | 2.8    |     |                 | MHz |
| $\phi_m$ Phase margin at unity gain                     | $V_I = 10$ mV,<br>$C_L = 25$ pF,   | $R_L = 2$ k $\Omega$ ,<br>See Figure 2    | 25°C     | 56°    |     |           | 56°    |     |                 |     |

† Full range is 0°C to 70°C.

# TLE208x, TLE208xA, TLE208xY EXCALIBUR HIGH-SPEED JFET-INPUT OPERATIONAL AMPLIFIERS

SLOS182B – FEBRUARY 1997 – REVISED JUNE 2001

**TLE2082C electrical characteristics at specified free-air temperature,  $V_{CC\pm} = \pm 15\text{ V}$  (unless otherwise noted)**

| PARAMETER   | TEST CONDITIONS  | $T_A$ †                       | TLE2082C    |             |     | TLE2082AC   |             |                              | UNIT     |    |
|---|--|-------------------------------|-------------|-------------|-----|-------------|-------------|------------------------------|----------|----|
|   |  |                               | MIN         | TYP         | MAX | MIN         | TYP         | MAX                          |          |    |
| $V_{IO}$ Input offset voltage   | $V_{IC} = 0,$<br>$R_S = 50\ \Omega$<br>$V_O = 0,$  | 25°C                          | 1.1         | 7           |     | 0.7         | 4           | mV                           |          |    |
|   |  | Full range                    |             |             | 8.1 |             | 5.1         |                              |          |    |
| $\alpha_{VIO}$ Temperature coefficient of input offset voltage                |  | Full range                    | 2.4         | 25          |     | 2.4         | 25          | $\mu\text{V}/^\circ\text{C}$ |          |    |
| $I_{IO}$ Input offset current   | $V_{IC} = 0,$<br>$V_O = 0,$<br>See Figure 4  | 25°C                          | 6           | 100         |     | 6           | 100         | pA                           |          |    |
|   |  | Full range                    |             |             | 1.4 |             | 1.4         | nA                           |          |    |
| $I_{IB}$ Input bias current   |  | 25°C                          | 20          | 175         |     | 20          | 175         | pA                           |          |    |
|   |  | Full range                    |             |             | 5   |             | 5           | nA                           |          |    |
| $V_{ICR}$ Common-mode input voltage range                                     | $R_S = 50\ \Omega$   | 25°C                          | 15 to -11   | 15 to -11.9 |     | 15 to -11   | 15 to -11.9 | V                            |          |    |
|   |  | Full range                    | 15 to -10.9 |             |     | 15 to -10.9 |             |                              |          |    |
| $V_{OM+}$ Maximum positive peak output voltage swing                          | $I_O = -200\ \mu\text{A}$  | 25°C                          | 13.8        | 14.1        |     | 13.8        | 14.1        | V                            |          |    |
|   |  | Full range                    | 13.6        |             |     | 13.6        |             |                              |          |    |
|   | $I_O = -2\ \text{mA}$  | 25°C                          | 13.5        | 13.9        |     | 13.5        | 13.9        |                              |          |    |
|   |  | Full range                    | 13.4        |             |     | 13.4        |             |                              |          |    |
|   | $I_O = -20\ \text{mA}$   | 25°C                          | 11.5        | 12.3        |     | 11.5        | 12.3        |                              |          |    |
|   |  | Full range                    | 11.5        |             |     | 11.5        |             |                              |          |    |
| $V_{OM-}$ Maximum negative peak output voltage swing                          | $I_O = 200\ \mu\text{A}$   | 25°C                          | -13.8       | -14.2       |     | -13.8       | -14.2       | V                            |          |    |
|   |  | Full range                    | -13.7       |             |     | -13.7       |             |                              |          |    |
|   | $I_O = 2\ \text{mA}$   | 25°C                          | -13.5       | -14         |     | -13.5       | -14         |                              |          |    |
|   |  | Full range                    | -13.4       |             |     | -13.4       |             |                              |          |    |
|   | $I_O = 20\ \text{mA}$  | 25°C                          | -11.5       | -12.4       |     | -11.5       | -12.4       |                              |          |    |
|   |  | Full range                    | -11.5       |             |     | -11.5       |             |                              |          |    |
| $A_{VD}$ Large-signal differential voltage amplification                      | $V_O = \pm 10\ \text{V}$   | $R_L = 600\ \Omega$           | 25°C        | 80          | 96  |             | 80          | 96                           | dB       |    |
|   |  |                               | Full range  | 79          |     |             | 79          |                              |          |    |
|   |  | $R_L = 2\ \text{k}\Omega$     | 25°C        | 90          | 109 |             | 90          | 109                          |          |    |
|   |  |                               | Full range  | 89          |     |             | 89          |                              |          |    |
|   |  | $R_L = 10\ \text{k}\Omega$    | 25°C        | 95          | 118 |             | 95          | 118                          |          |    |
|   |  |                               | Full range  | 94          |     |             | 94          |                              |          |    |
| $r_i$ Input resistance  | $V_{IC} = 0$   | 25°C                          | $10^{12}$   |             |     | $10^{12}$   |             |                              | $\Omega$ |    |
| $c_i$ Input capacitance   | Common mode  | $V_{IC} = 0,$<br>See Figure 5 | 25°C        | 7.5         |     |             | 7.5         |                              |          | pF |
|   | Differential   |                               | 25°C        | 2.5         |     |             | 2.5         |                              |          |    |
| $z_o$ Open-loop output impedance  | $f = 1\ \text{MHz}$  | 25°C                          | 80          |             |     | 80          |             |                              | $\Omega$ |    |
| CMRR Common-mode rejection ratio  | $V_{IC} = V_{ICRmin},$<br>$V_O = 0,$<br>$R_S = 50\ \Omega$                               | 25°C                          | 80          | 98          |     | 80          | 98          | dB                           |          |    |
|   |  | Full range                    | 79          |             |     | 79          |             |                              |          |    |
| $k_{SVR}$ Supply-voltage rejection ratio ( $\Delta V_{CC\pm}/\Delta V_{IO}$ ) | $V_{CC\pm} = \pm 5\ \text{V}$ to $\pm 15\ \text{V},$<br>$V_O = 0,$<br>$R_S = 50\ \Omega$ | 25°C                          | 82          | 99          |     | 82          | 99          | dB                           |          |    |
|   |  | Full range                    | 81          |             |     | 81          |             |                              |          |    |

† Full range is 0°C to 70°C.



**TLE208x, TLE208xA, TLE208xY**  
**EXCALIBUR HIGH-SPEED JFET-INPUT**  
**OPERATIONAL AMPLIFIERS**

SLOS182B – FEBRUARY 1997 – REVISED JUNE 2001

**TLE2082C electrical characteristics at specified free-air temperature,  $V_{CC\pm} = \pm 15$  V (unless otherwise noted) (continued)**

| PARAMETER                               | TEST CONDITIONS                     | $T_A$           | TLE2082C |     |     | TLE2082AC |     |     | UNIT |
|---|-------------------------------------|-----------------|----------|-----|-----|-----------|-----|-----|------|
|   |                                     |                 | MIN      | TYP | MAX | MIN       | TYP | MAX |      |
| $I_{CC}$ Supply current (both channels) | $V_O = 0$ , No load                 | 25°C            | 2.7      | 3.1 | 3.9 | 2.7       | 3.1 | 3.9 | mA   |
|   |                                     | Full range      | 3.9      |     |     | 3.9       |     |     |      |
| Crosstalk attenuation                   | $V_{IC} = 0$ , $R_L = 2$ k $\Omega$ | 25°C            | 120      |     |     | 120       |     |     | dB   |
| $I_{OS}$ Short-circuit output current   | $V_O = 0$                           | $V_{ID} = 1$ V  | 25°C     | -30 | -45 | -30       | -45 | mA  |      |
|   |                                     | $V_{ID} = -1$ V | 30       | 48  | 30  | 48        |     |     |      |

**TLE2082C operating characteristics at specified free-air temperature,  $V_{CC\pm} = \pm 15$  V**

| PARAMETER   | TEST CONDITIONS  | $T_A$ †             | TLE2082C |     |     | TLE2082AC |     |            | UNIT            |
|---|--|---------------------|----------|-----|-----|-----------|-----|------------|-----------------|
|   |  |                     | MIN      | TYP | MAX | MIN       | TYP | MAX        |                 |
| SR+ Positive slew rate                                  | $V_{O(PP)} = 10$ V, $A_{VD} = -1$ ,<br>$R_L = 2$ k $\Omega$ ,<br>$C_L = 100$ pF,<br>See Figure 1 | 25°C                | 28       | 40  |     | 28        | 40  | V/ $\mu$ s |                 |
|   |  | Full range          | 25       |     |     | 25        |     |            |                 |
| SR- Negative slew rate                                  |  | 25°C                | 30       | 45  |     | 30        | 45  | V/ $\mu$ s |                 |
|   |  | Full range          | 25       |     |     | 25        |     |            |                 |
| $t_s$ Settling time                                     | $A_{VD} = -1$ ,<br>10-V step,<br>$R_L = 1$ k $\Omega$ ,<br>$C_L = 100$ pF                        | To 10 mV            | 0.4      |     |     | 0.4       |     |            | $\mu$ s         |
|   |  | To 1 mV             | 1.5      |     |     | 1.5       |     |            |                 |
| $V_n$ Equivalent input noise voltage                    | $R_S = 20$ $\Omega$ ,<br>See Figure 3  | f = 10 Hz           | 28       |     |     | 28        |     |            | nV/ $\sqrt{Hz}$ |
|   |  | f = 10 kHz          | 11.6     |     |     | 11.6      |     |            |                 |
| $V_{N(PP)}$ Peak-to-peak equivalent input noise voltage |  | f = 10 Hz to 10 kHz | 6        |     |     | 6         |     |            | $\mu$ V         |
|   |  | f = 0.1 Hz to 10 Hz | 0.6      |     |     | 0.6       |     |            |                 |
| $I_n$ Equivalent input noise current                    | $V_{IC} = 0$ , f = 10 kHz  | 25°C                | 2.8      |     |     | 2.8       |     |            | fA/ $\sqrt{Hz}$ |
| THD + N Total harmonic distortion plus noise            | $V_{O(PP)} = 20$ V, $A_{VD} = 10$ ,<br>f = 1 kHz,<br>$R_S = 25$ $\Omega$                         | 25°C                | 0.008%   |     |     | 0.008%    |     |            |                 |
| $B_1$ Unity-gain bandwidth                              | $V_I = 10$ mV, $R_L = 2$ k $\Omega$ ,<br>$C_L = 25$ pF, See Figure 2                             | 25°C                | 8        | 10  |     | 8         | 10  | MHz        |                 |
| $B_{OM}$ Maximum output-swing bandwidth                 | $V_{O(PP)} = 20$ V, $A_{VD} = -1$ ,<br>$R_L = 2$ k $\Omega$ ,<br>$C_L = 25$ pF                   | 25°C                | 478      | 637 |     | 478       | 637 | kHz        |                 |
| $\phi_m$ Phase margin at unity gain                     | $V_I = 10$ mV, $R_L = 2$ k $\Omega$ ,<br>$C_L = 25$ pF, See Figure 2                             | 25°C                | 57°      |     |     | 57°       |     |            |                 |

† Full range is 0°C to 70°C.

# TLE208x, TLE208xA, TLE208xY EXCALIBUR HIGH-SPEED JFET-INPUT OPERATIONAL AMPLIFIERS

SLOS182B – FEBRUARY 1997 – REVISED JUNE 2001

**TLE2082I electrical characteristics at specified free-air temperature,  $V_{CC\pm} = \pm 5\text{ V}$  (unless otherwise noted)**

| PARAMETER   | TEST CONDITIONS   | $T_A$ †                    | TLE2082I   |           |     | TLE2082AI |           |                              | UNIT     |    |
|---|---|----------------------------|------------|-----------|-----|-----------|-----------|------------------------------|----------|----|
|   |   |                            | MIN        | TYP       | MAX | MIN       | TYP       | MAX                          |          |    |
| $V_{IO}$ Input offset voltage   | $V_{IC} = 0, V_O = 0, R_S = 50\ \Omega$                                       | 25°C                       | 0.9        | 7         |     | 0.65      | 4         | mV                           |          |    |
|   |   | Full range                 |            |           | 8.5 |           | 5.5       |                              |          |    |
| $\alpha_{VIO}$ Temperature coefficient of input offset voltage                |   | Full range                 | 2.4        | 25        |     | 2.4       | 25        | $\mu\text{V}/^\circ\text{C}$ |          |    |
| $I_{IO}$ Input offset current   | $V_{IC} = 0, V_O = 0, \text{See Figure 4}$                                    | 25°C                       | 5          | 100       |     | 5         | 100       | pA                           |          |    |
|   |   | Full range                 |            |           | 5   |           | 5         | nA                           |          |    |
| $I_{IB}$ Input bias current   |   | 25°C                       | 15         | 175       |     | 15        | 175       | pA                           |          |    |
|   |   | Full range                 |            |           | 10  |           | 10        | nA                           |          |    |
| $V_{ICR}$ Common-mode input voltage range                                     | $R_S = 50\ \Omega$  | 25°C                       | 5 to -1    | 5 to -1.9 |     | 5 to -1   | 5 to -1.9 | V                            |          |    |
|   |   | Full range                 | 5 to -0.8  |           |     | 5 to -0.8 |           |                              |          |    |
| $V_{OM+}$ Maximum positive peak output voltage swing                          | $I_O = -200\ \mu\text{A}$   | 25°C                       | 3.8        | 4.1       |     | 3.8       | 4.1       | V                            |          |    |
|   |   | Full range                 | 3.7        |           |     | 3.7       |           |                              |          |    |
|   | $I_O = -2\ \text{mA}$   | 25°C                       | 3.5        | 3.9       |     | 3.5       | 3.9       |                              |          |    |
|   |   | Full range                 | 3.4        |           |     | 3.4       |           |                              |          |    |
|   | $I_O = -20\ \text{mA}$  | 25°C                       | 1.5        | 2.3       |     | 1.5       | 2.3       |                              |          |    |
|   |   | Full range                 | 1.5        |           |     | 1.5       |           |                              |          |    |
| $V_{OM-}$ Maximum negative peak output voltage swing                          | $I_O = 200\ \mu\text{A}$  | 25°C                       | -3.8       | -4.2      |     | -3.8      | -4.2      | V                            |          |    |
|   |   | Full range                 | -3.7       |           |     | -3.7      |           |                              |          |    |
|   | $I_O = 2\ \text{mA}$  | 25°C                       | -3.5       | -4.1      |     | -3.5      | -4.1      |                              |          |    |
|   |   | Full range                 | -3.4       |           |     | -3.4      |           |                              |          |    |
|   | $I_O = 20\ \text{mA}$   | 25°C                       | -1.5       | -2.4      |     | -1.5      | -2.4      |                              |          |    |
|   |   | Full range                 | -1.5       |           |     | -1.5      |           |                              |          |    |
| $A_{VD}$ Large-signal differential voltage amplification                      | $V_O = \pm 2.3\ \text{V}$   | $R_L = 600\ \Omega$        | 25°C       | 80        | 91  |           | 80        | 91                           | dB       |    |
|   |   |                            | Full range | 79        |     |           | 79        |                              |          |    |
|   |   | $R_L = 2\ \text{k}\Omega$  | 25°C       | 90        | 100 |           | 90        | 100                          |          |    |
|   |   |                            | Full range | 89        |     |           | 89        |                              |          |    |
|   |   | $R_L = 10\ \text{k}\Omega$ | 25°C       | 95        | 106 |           | 95        | 106                          |          |    |
|   |   |                            | Full range | 94        |     |           | 94        |                              |          |    |
| $r_i$ Input resistance  | $V_{IC} = 0$  | 25°C                       | $10^{12}$  |           |     | $10^{12}$ |           |                              | $\Omega$ |    |
| $c_i$ Input capacitance   | Common mode   | $V_{IC} = 0,$              | 25°C       | 11        |     |           | 11        |                              |          | pF |
|   | Differential  | See Figure 5               | 25°C       | 2.5       |     |           | 2.5       |                              |          |    |
| $z_o$ Open-loop output impedance  | $f = 1\ \text{MHz}$   | 25°C                       | 80         |           |     | 80        |           |                              | $\Omega$ |    |
| CMRR Common-mode rejection ratio  | $V_{IC} = V_{ICRmin}, V_O = 0, R_S = 50\ \Omega$                              | 25°C                       | 70         | 89        |     | 70        | 89        | dB                           |          |    |
|   |   | Full range                 | 68         |           |     | 68        |           |                              |          |    |
| $k_{SVR}$ Supply-voltage rejection ratio ( $\Delta V_{CC\pm}/\Delta V_{IO}$ ) | $V_{CC\pm} = \pm 5\ \text{V to } \pm 15\ \text{V}, V_O = 0, R_S = 50\ \Omega$ | 25°C                       | 82         | 99        |     | 82        | 99        | dB                           |          |    |
|   |   | Full range                 | 80         |           |     | 80        |           |                              |          |    |
| $I_{CC}$ Supply current (both channels)                                       | $V_O = 0, \text{No load}$   | 25°C                       | 2.7        | 2.9       | 3.9 | 2.7       | 2.9       | 3.9                          | mA       |    |
|   |   | Full range                 |            |           | 3.9 |           |           | 3.9                          |          |    |

† Full range is  $-40^\circ\text{C}$  to  $85^\circ\text{C}$ .



**TLE208x, TLE208xA, TLE208xY**  
**EXCALIBUR HIGH-SPEED JFET-INPUT**  
**OPERATIONAL AMPLIFIERS**

SLOS182B – FEBRUARY 1997 – REVISED JUNE 2001

**TLE2082I electrical characteristics at specified free-air temperature,  $V_{CC\pm} = \pm 5\text{ V}$  (unless otherwise noted) (continued)**

| PARAMETER                             | TEST CONDITIONS                         | $T_A$ | TLE2082I               |     |     | TLE2082AI |     |     | UNIT |
|---------------------------------------|---|-------|------------------------|-----|-----|-----------|-----|-----|------|
|                                       |   |       | MIN                    | TYP | MAX | MIN       | TYP | MAX |      |
| Crosstalk attenuation                 | $V_{IC} = 0$ , $R_L = 2\text{ k}\Omega$ | 25°C  | 120                    |     |     | 120       |     |     | dB   |
| $I_{OS}$ Short-circuit output current | $V_O = 0$                               | 25°C  | $V_{ID} = 1\text{ V}$  |     |     | -35       |     |     | mA   |
|                                       |   |       | $V_{ID} = -1\text{ V}$ |     |     | 45        |     |     |      |

**TLE2082I operating characteristics at specified free-air temperature,  $V_{CC\pm} = \pm 5\text{ V}$**

| PARAMETER   | TEST CONDITIONS  | $T_A$ †                                       | TLE2082I            |        |     | TLE2082AI |        |     | UNIT                   |     |
|---|--|---|---------------------|--------|-----|-----------|--------|-----|------------------------|-----|
|   |  |   | MIN                 | TYP    | MAX | MIN       | TYP    | MAX |                        |     |
| SR+ Positive slew rate                                  | $V_{O(PP)} = \pm 2.3\text{ V}$ ,<br>$A_{VD} = -1$ ,<br>$R_L = 2\text{ k}\Omega$ ,<br>$C_L = 100\text{ pF}$ ,<br>See Figure 1 | 25°C  | 35                  |        |     | 35        |        |     | V/ $\mu$ s             |     |
|   |  | Full range                                    | 20                  |        |     | 20        |        |     |                        |     |
| SR- Negative slew rate                                  | $V_{O(PP)} = \pm 2.3\text{ V}$ ,<br>$A_{VD} = -1$ ,<br>$R_L = 2\text{ k}\Omega$ ,<br>$C_L = 100\text{ pF}$ ,<br>See Figure 1 | 25°C  | 38                  |        |     | 38        |        |     | V/ $\mu$ s             |     |
|   |  | Full range                                    | 20                  |        |     | 20        |        |     |                        |     |
| $t_s$ Settling time                                     | $A_{VD} = -1$ ,<br>2-V step,<br>$R_L = 1\text{ k}\Omega$ ,<br>$C_L = 100\text{ pF}$  | 25°C  | To 10 mV            |        |     | 0.25      |        |     | $\mu$ s                |     |
|   |  |   | To 1 mV             |        |     | 0.4       |        |     |                        |     |
| $V_n$ Equivalent input noise voltage                    | $R_S = 20\ \Omega$ ,<br>See Figure 3   | 25°C  | f = 10 Hz           |        |     | 28        |        |     | nV/ $\sqrt{\text{Hz}}$ |     |
|   |  |   | f = 10 kHz          |        |     | 11.6      |        |     |                        |     |
| $V_{N(PP)}$ Peak-to-peak equivalent input noise voltage | $R_S = 20\ \Omega$ ,<br>See Figure 3   | 25°C  | f = 10 Hz to 10 kHz |        |     | 6         |        |     | $\mu$ V                |     |
|   |  |   | f = 0.1 Hz to 10 Hz |        |     | 0.6       |        |     |                        |     |
| $I_n$ Equivalent input noise current                    | $V_{IC} = 0$ , f = 10 kHz  | 25°C  | 2.8                 |        |     | 2.8       |        |     | fA/ $\sqrt{\text{Hz}}$ |     |
| THD + N Total harmonic distortion plus noise            | $V_{O(PP)} = 5\text{ V}$ ,<br>f = 1 kHz,<br>$R_S = 25\ \Omega$   | $A_{VD} = 10$ ,<br>$R_L = 2\text{ k}\Omega$ , | 25°C                | 0.013% |     |           | 0.013% |     |                        |     |
| $B_1$ Unity-gain bandwidth                              | $V_I = 10\text{ mV}$ ,<br>$C_L = 25\text{ pF}$ ,   | $R_L = 2\text{ k}\Omega$ ,<br>See Figure 2    | 25°C                | 9.4    |     |           | 9.4    |     |                        | MHz |
| $B_{OM}$ Maximum output-swing bandwidth                 | $V_{O(PP)} = 4\text{ V}$ ,<br>$R_L = 2\text{ k}\Omega$ ,   | $A_{VD} = -1$ ,<br>$C_L = 25\text{ pF}$       | 25°C                | 2.8    |     |           | 2.8    |     |                        | MHz |
| $\phi_m$ Phase margin at unity gain                     | $V_I = 10\text{ mV}$ ,<br>$C_L = 25\text{ pF}$ ,   | $R_L = 2\text{ k}\Omega$ ,<br>See Figure 2    | 25°C                | 56°    |     |           | 56°    |     |                        |     |

† Full range is 40°C to 85°C.

# TLE208x, TLE208xA, TLE208xY EXCALIBUR HIGH-SPEED JFET-INPUT OPERATIONAL AMPLIFIERS

SLOS182B – FEBRUARY 1997 – REVISED JUNE 2001

**TLE2082I electrical characteristics at specified free-air temperature,  $V_{CC\pm} = \pm 15\text{ V}$  (unless otherwise noted)**

| PARAMETER   | TEST CONDITIONS   | $T_A$ †                       | TLE2082I    |             |     | TLE2082AI   |             |                              | UNIT     |    |
|---|---|-------------------------------|-------------|-------------|-----|-------------|-------------|------------------------------|----------|----|
|   |   |                               | MIN         | TYP         | MAX | MIN         | TYP         | MAX                          |          |    |
| $V_{IO}$ Input offset voltage   | $V_{IC} = 0,$<br>$R_S = 50\ \Omega$<br>$V_O = 0,$                                       | 25°C                          | 1.1         | 7           |     | 0.7         | 4           | mV                           |          |    |
|   |   | Full range                    |             |             | 8.5 |             | 5.5         |                              |          |    |
| $\alpha_{VIO}$ Temperature coefficient of input offset voltage                  |   | Full range                    | 2.4         | 25          |     | 2.4         | 25          | $\mu\text{V}/^\circ\text{C}$ |          |    |
| $I_{IO}$ Input offset current   | $V_{IC} = 0,$<br>$V_O = 0,$<br>See Figure 4   | 25°C                          | 6           | 100         |     | 6           | 100         | pA                           |          |    |
|   |   | Full range                    |             |             | 5   |             | 5           | nA                           |          |    |
| $I_{IB}$ Input bias current   |   | 25°C                          | 20          | 175         |     | 20          | 175         | pA                           |          |    |
|   |   | Full range                    |             |             | 10  |             | 10          | nA                           |          |    |
| $V_{ICR}$ Common-mode input voltage range                                       | $R_S = 50\ \Omega$  | 25°C                          | 15 to -11   | 15 to -11.9 |     | 15 to -11   | 15 to -11.9 | V                            |          |    |
|   |   | Full range                    | 15 to -10.8 |             |     | 15 to -10.8 |             |                              |          |    |
| $V_{OM+}$ Maximum positive peak output voltage swing                            | $I_O = -200\ \mu\text{A}$   | 25°C                          | 13.8        | 14.1        |     | 13.8        | 14.1        | V                            |          |    |
|   |   | Full range                    | 13.7        |             |     | 13.7        |             |                              |          |    |
|   | $I_O = -2\ \text{mA}$   | 25°C                          | 13.5        | 13.9        |     | 13.5        | 13.9        |                              |          |    |
|   |   | Full range                    | 13.4        |             |     | 13.4        |             |                              |          |    |
|   | $I_O = -20\ \text{mA}$  | 25°C                          | 11.5        | 12.3        |     | 11.5        | 12.3        |                              |          |    |
|   |   | Full range                    | 11.5        |             |     | 11.5        |             |                              |          |    |
| $V_{OM-}$ Maximum negative peak output voltage swing                            | $I_O = 200\ \mu\text{A}$  | 25°C                          | -13.8       | -14.2       |     | -13.8       | -14.2       | V                            |          |    |
|   |   | Full range                    | -13.7       |             |     | -13.7       |             |                              |          |    |
|   | $I_O = 2\ \text{mA}$  | 25°C                          | -13.5       | -14         |     | -13.5       | -14         |                              |          |    |
|   |   | Full range                    | -13.4       |             |     | -13.4       |             |                              |          |    |
|   | $I_O = 20\ \text{mA}$   | 25°C                          | -11.5       | -12.4       |     | -11.5       | -12.4       |                              |          |    |
|   |   | Full range                    | -11.5       |             |     | -11.5       |             |                              |          |    |
| $A_{VD}$ Large-signal differential voltage amplification                        | $V_O = \pm 10\ \text{V}$  | $R_L = 600\ \Omega$           | 25°C        | 80          | 96  |             | 80          | 96                           | dB       |    |
|   |   |                               | Full range  | 79          |     |             | 79          |                              |          |    |
|   |   | $R_L = 2\ \text{k}\Omega$     | 25°C        | 90          | 109 |             | 90          | 109                          |          |    |
|   |   |                               | Full range  | 89          |     |             | 89          |                              |          |    |
|   |   | $R_L = 10\ \text{k}\Omega$    | 25°C        | 95          | 118 |             | 95          | 118                          |          |    |
|   |   |                               | Full range  | 94          |     |             | 94          |                              |          |    |
| $r_i$ Input resistance  | $V_{IC} = 0$  | 25°C                          | $10^{12}$   |             |     | $10^{12}$   |             |                              | $\Omega$ |    |
| $c_i$ Input capacitance   | Common mode   | $V_{IC} = 0,$<br>See Figure 5 | 25°C        | 7.5         |     |             | 7.5         |                              |          | pF |
|   | Differential  |                               | 25°C        | 2.5         |     |             | 2.5         |                              |          |    |
| $z_o$ Open-loop output impedance  | $f = 1\ \text{MHz}$   | 25°C                          | 80          |             |     | 80          |             |                              | $\Omega$ |    |
| CMRR Common-mode rejection ratio  | $V_{IC} = V_{ICRmin},$<br>$V_O = 0,$<br>$R_S = 50\ \Omega$                              | 25°C                          | 80          | 98          |     | 80          | 98          | dB                           |          |    |
|   |   | Full range                    | 79          |             |     | 79          |             |                              |          |    |
| $k_{SVR}$ Supply-voltage rejection ratio ( $\Delta V_{CC\pm} / \Delta V_{IO}$ ) | $V_{CC\pm} = \pm 5\ \text{V to } \pm 15\ \text{V},$<br>$V_O = 0,$<br>$R_S = 50\ \Omega$ | 25°C                          | 82          | 99          |     | 82          | 99          | dB                           |          |    |
|   |   | Full range                    | 80          |             |     | 80          |             |                              |          |    |

† Full range is  $-40^\circ\text{C}$  to  $85^\circ\text{C}$ .



**TLE208x, TLE208xA, TLE208xY**  
**EXCALIBUR HIGH-SPEED JFET-INPUT**  
**OPERATIONAL AMPLIFIERS**

SLOS182B – FEBRUARY 1997 – REVISED JUNE 2001

**TLE2082I electrical characteristics at specified free-air temperature,  $V_{CC\pm} = \pm 15$  V (unless otherwise noted) (continued)**

| PARAMETER                               | TEST CONDITIONS                     | $T_A$      | TLE2082I        |     |     | TLE2082AI |     |     | UNIT |
|---|-------------------------------------|------------|-----------------|-----|-----|-----------|-----|-----|------|
|   |                                     |            | MIN             | TYP | MAX | MIN       | TYP | MAX |      |
| $I_{CC}$ Supply current (both channels) | $V_O = 0$ , No load                 | 25°C       | 2.7             | 3.1 | 3.9 | 2.7       | 3.1 | 3.9 | mA   |
|   |                                     | Full range | 3.9             |     |     | 3.9       |     |     |      |
| Crosstalk attenuation                   | $V_{IC} = 0$ , $R_L = 2$ k $\Omega$ | 25°C       | 120             |     |     | 120       |     |     | dB   |
| $I_{OS}$ Short-circuit output current   | $V_O = 0$                           | 25°C       | $V_{ID} = 1$ V  | -30 | -45 | -30       | -45 | mA  |      |
|   |                                     |            | $V_{ID} = -1$ V | 30  | 48  | 30        | 48  |     |      |

**TLE2082I operating characteristics at specified free-air temperature,  $V_{CC\pm} = \pm 15$  V**

| PARAMETER   | TEST CONDITIONS  | $T_A$ †    | TLE2082I            |      |        | TLE2082AI |                        |                        | UNIT |
|---|--|------------|---------------------|------|--------|-----------|------------------------|------------------------|------|
|   |  |            | MIN                 | TYP  | MAX    | MIN       | TYP                    | MAX                    |      |
| SR+ Positive slew rate                                  | $V_{O(PP)} = 10$ V, $A_{VD} = -1$ ,<br>$R_L = 2$ k $\Omega$ ,<br>$C_L = 100$ pF,<br>See Figure 1 | 25°C       | 28                  | 40   |        | 28        | 40                     | V/ $\mu$ s             |      |
|   |  | Full range | 22                  |      |        | 22        |                        |                        |      |
| SR- Negative slew rate                                  |  | 25°C       | 30                  | 45   |        | 30        | 45                     | V/ $\mu$ s             |      |
|   |  | Full range | 22                  |      |        | 22        |                        |                        |      |
| $t_s$ Settling time                                     | $A_{VD} = -1$ ,<br>10-V step,<br>$R_L = 1$ k $\Omega$ ,<br>$C_L = 100$ pF                        | 25°C       | To 10 mV            | 0.4  |        | 0.4       |                        | $\mu$ s                |      |
|   |  |            | To 1 mV             | 1.5  |        | 1.5       |                        |                        |      |
| $V_n$ Equivalent input noise voltage                    | $R_S = 20$ $\Omega$ ,<br>See Figure 3  | 25°C       | f = 10 Hz           | 28   |        | 28        |                        | nV/ $\sqrt{\text{Hz}}$ |      |
|   |  |            | f = 10 kHz          | 11.6 |        | 11.6      |                        |                        |      |
| $V_{N(PP)}$ Peak-to-peak equivalent input noise voltage |  | 25°C       | f = 10 Hz to 10 kHz | 6    |        | 6         |                        | $\mu$ V                |      |
|   |  |            | f = 0.1 Hz to 10 Hz | 0.6  |        | 0.6       |                        |                        |      |
| $I_n$ Equivalent input noise current                    | $V_{IC} = 0$ , f = 10 kHz  | 25°C       | 2.8                 |      | 2.8    |           | fA/ $\sqrt{\text{Hz}}$ |                        |      |
| THD + N Total harmonic distortion plus noise            | $V_{O(PP)} = 20$ V, $A_{VD} = 10$ ,<br>f = 1 kHz, $R_L = 2$ k $\Omega$ ,<br>$R_S = 25$ $\Omega$  | 25°C       | 0.008%              |      | 0.008% |           |                        |                        |      |
| $B_1$ Unity-gain bandwidth                              | $V_I = 10$ mV, $R_L = 2$ k $\Omega$ ,<br>$C_L = 25$ pF, See Figure 2                             | 25°C       | 8                   | 10   | 8      | 10        | MHz                    |                        |      |
| $B_{OM}$ Maximum output-swing bandwidth                 | $V_{O(PP)} = 20$ V, $A_{VD} = -1$ ,<br>$R_L = 2$ k $\Omega$ , $C_L = 25$ pF                      | 25°C       | 478                 | 637  | 478    | 637       | kHz                    |                        |      |
| $\phi_m$ Phase margin at unity gain                     | $V_I = 10$ mV, $R_L = 2$ k $\Omega$ ,<br>$C_L = 25$ pF, See Figure 2                             | 25°C       | 57°                 |      | 57°    |           |                        |                        |      |

† Full range is -40°C to 85°C.

# TLE208x, TLE208xA, TLE208xY EXCALIBUR HIGH-SPEED JFET-INPUT OPERATIONAL AMPLIFIERS

SLOS182B – FEBRUARY 1997 – REVISED JUNE 2001

**TLE2082M electrical characteristics at specified free-air temperature,  $V_{CC\pm} = \pm 5\text{ V}$  (unless otherwise noted)**

| PARAMETER   | TEST CONDITIONS   | $T_A$ †                           | TLE2082M   |           |      | TLE2082AM |           |                              | UNIT     |    |
|---|---|-----------------------------------|------------|-----------|------|-----------|-----------|------------------------------|----------|----|
|   |   |                                   | MIN        | TYP       | MAX  | MIN       | TYP       | MAX                          |          |    |
| $V_{IO}$ Input offset voltage   | $V_{IC} = 0, V_O = 0, R_S = 50\ \Omega$                                       | 25°C                              | 0.9        | 7         |      | 0.65      | 4         | mV                           |          |    |
|   |   | Full range                        |            |           | 9.5  |           | 6.5       |                              |          |    |
| $\alpha_{VIO}$ Temperature coefficient of input offset voltage                  |   | Full range                        | 2.3        | 25*       |      | 2.3       | 25*       | $\mu\text{V}/^\circ\text{C}$ |          |    |
| $I_{IO}$ Input offset current   | $V_{IC} = 0, V_O = 0, \text{See Figure 4}$                                    | 25°C                              | 5          | 100       |      | 5         | 100       | pA                           |          |    |
|   |   | Full range                        |            |           | 20   |           | 20        |                              |          |    |
| $I_{IB}$ Input bias current   |   | 25°C                              | 15         | 175       |      | 15        | 175       | pA                           |          |    |
|   |   | Full range                        |            |           | 60   |           | 60        |                              |          |    |
| $V_{ICR}$ Common-mode input voltage range                                       | $R_S = 50\ \Omega$  | 25°C                              | 5 to -1    | 5 to -1.9 |      | 5 to -1   | 5 to -1.9 | V                            |          |    |
|   |   | Full range                        | 5 to -0.8  |           |      | 5 to -0.8 |           |                              |          |    |
| $V_{OM+}$ Maximum positive peak output voltage swing                            | $I_O = -200\ \mu\text{A}$   | 25°C                              | 3.8        | 4.1       |      | 3.8       | 4.1       | V                            |          |    |
|   |   | Full range                        | 3.6        |           |      | 3.6       |           |                              |          |    |
|   | $I_O = -2\ \text{mA}$   | 25°C                              | 3.5        | 3.9       |      | 3.5       | 3.9       |                              |          |    |
|   |   | Full range                        | 3.3        |           |      | 3.3       |           |                              |          |    |
| $I_O = -20\ \text{mA}$  | 25°C  | 1.5                               | 2.3        |           | 1.5  | 2.3       |           |                              |          |    |
|   | Full range  | 1.4                               |            |           | 1.4  |           |           |                              |          |    |
| $V_{OM-}$ Maximum negative peak output voltage swing                            | $I_O = 200\ \mu\text{A}$  | 25°C                              | -3.8       | -4.2      |      | -3.8      | -4.2      | V                            |          |    |
|   |   | Full range                        | -3.6       |           |      | -3.6      |           |                              |          |    |
|   | $I_O = 2\ \text{mA}$  | 25°C                              | -3.5       | -4.1      |      | -3.5      | -4.1      |                              |          |    |
|   |   | Full range                        | -3.3       |           |      | -3.3      |           |                              |          |    |
| $I_O = 20\ \text{mA}$   | 25°C  | -1.5                              | -2.4       |           | -1.5 | -2.4      |           |                              |          |    |
|   | Full range  | -1.4                              |            |           | -1.4 |           |           |                              |          |    |
| $A_{VD}$ Large-signal differential voltage amplification                        | $V_O = \pm 2.3\ \text{V}$   | $R_L = 600\ \Omega$               | 25°C       | 80        | 91   |           | 80        | 91                           | dB       |    |
|   |   |                                   | Full range | 78        |      |           | 78        |                              |          |    |
|   |   | $R_L = 2\ \text{k}\Omega$         | 25°C       | 90        | 100  |           | 90        | 100                          |          |    |
|   |   |                                   | Full range | 88        |      |           | 88        |                              |          |    |
|   |   | $R_L = 10\ \text{k}\Omega$        | 25°C       | 95        | 106  |           | 95        | 106                          |          |    |
|   |   |                                   | Full range | 93        |      |           | 93        |                              |          |    |
| $r_i$ Input resistance  | $V_{IC} = 0$  | 25°C                              | $10^{12}$  |           |      | $10^{12}$ |           |                              | $\Omega$ |    |
| $c_i$ Input capacitance   | Common mode   | $V_{IC} = 0, \text{See Figure 5}$ | 25°C       | 11        |      |           | 11        |                              |          | pF |
|   | Differential  |                                   | 25°C       | 2.5       |      |           | 2.5       |                              |          |    |
| $z_o$ Open-loop output impedance  | $f = 1\ \text{MHz}$   | 25°C                              | 80         |           |      | 80        |           |                              | $\Omega$ |    |
| CMRR Common-mode rejection ratio  | $V_{IC} = V_{ICR\text{min}}, V_O = 0, R_S = 50\ \Omega$                       | 25°C                              | 70         | 89        |      | 70        | 89        | dB                           |          |    |
|   |   | Full range                        | 68         |           |      | 68        |           |                              |          |    |
| $k_{SVR}$ Supply-voltage rejection ratio ( $\Delta V_{CC\pm} / \Delta V_{IO}$ ) | $V_{CC\pm} = \pm 5\ \text{V to } \pm 15\ \text{V}, V_O = 0, R_S = 50\ \Omega$ | 25°C                              | 82         | 99        |      | 82        | 99        | dB                           |          |    |
|   |   | Full range                        | 80         |           |      | 80        |           |                              |          |    |

\*On products compliant with MIL-PRF-38535, Class B, this parameter is not production tested.

† Full range is  $-55^\circ\text{C}$  to  $125^\circ\text{C}$ .



**TLE208x, TLE208xA, TLE208xY**  
**EXCALIBUR HIGH-SPEED JFET-INPUT**  
**OPERATIONAL AMPLIFIERS**

SLOS182B – FEBRUARY 1997 – REVISED JUNE 2001

**TLE2082M electrical characteristics at specified free-air temperature,  $V_{CC\pm} = \pm 5\text{ V}$  (unless otherwise noted) (continued)**

| PARAMETER                               | TEST CONDITIONS                         | $T_A$ †    | TLE2082M               |     |     | TLE2082AM |     |     | UNIT |
|---|---|------------|------------------------|-----|-----|-----------|-----|-----|------|
|   |   |            | MIN                    | TYP | MAX | MIN       | TYP | MAX |      |
| $I_{CC}$ Supply current (both channels) | $V_O = 0$ , No load                     | 25°C       | 2.7                    | 2.9 | 3.6 | 2.7       | 2.9 | 3.6 | mA   |
|   |   | Full range | 3.6                    |     |     | 3.6       |     |     |      |
| Crosstalk attenuation                   | $V_{IC} = 0$ , $R_L = 2\text{ k}\Omega$ | 25°C       | 120                    |     |     | 120       |     |     | dB   |
| $I_{OS}$ Short-circuit output current   | $V_O = 0$                               | 25°C       | $V_{ID} = 1\text{ V}$  |     |     | -35       |     |     | mA   |
|   |   |            | $V_{ID} = -1\text{ V}$ |     |     | 45        |     |     |      |

† Full range is  $-55^\circ\text{C}$  to  $125^\circ\text{C}$ .

**TLE2082M operating characteristics at specified free-air temperature,  $V_{CC\pm} = \pm 5\text{ V}$**

| PARAMETER   | TEST CONDITIONS  | $T_A$ †                                     | TLE2082M            |        |     | TLE2082AM |        |     | UNIT                   |     |
|---|--|---|---------------------|--------|-----|-----------|--------|-----|------------------------|-----|
|   |  |   | MIN                 | TYP    | MAX | MIN       | TYP    | MAX |                        |     |
| SR+ Positive slew rate                                  | $V_{O(PP)} = \pm 2.3\text{ V}$ ,<br>$A_{VD} = -1$ ,<br>$R_L = 2\text{ k}\Omega$ ,<br>$C_L = 100\text{ pF}$ ,<br>See Figure 1 | 25°C  | 35                  |        |     | 35        |        |     | V/ $\mu\text{s}$       |     |
|   |  | Full range                                  | 18*                 |        |     | 18*       |        |     |                        |     |
| SR- Negative slew rate                                  | $V_{O(PP)} = \pm 2.3\text{ V}$ ,<br>$A_{VD} = -1$ ,<br>$R_L = 2\text{ k}\Omega$ ,<br>$C_L = 100\text{ pF}$ ,<br>See Figure 1 | 25°C  | 38                  |        |     | 38        |        |     | V/ $\mu\text{s}$       |     |
|   |  | Full range                                  | 18*                 |        |     | 18*       |        |     |                        |     |
| $t_s$ Settling time                                     | $A_{VD} = -1$ ,<br>2-V step,<br>$R_L = 1\text{ k}\Omega$ ,<br>$C_L = 100\text{ pF}$  | 25°C  | To 10 mV            |        |     | 0.25      |        |     | $\mu\text{s}$          |     |
|   |  |   | To 1 mV             |        |     | 0.4       |        |     |                        |     |
| $V_n$ Equivalent input noise voltage                    | $R_S = 20\ \Omega$ ,<br>See Figure 3   | 25°C  | f = 10 Hz           |        |     | 28        |        |     | nV/ $\sqrt{\text{Hz}}$ |     |
|   |  |   | f = 10 kHz          |        |     | 11.6      |        |     |                        |     |
| $V_{N(PP)}$ Peak-to-peak equivalent input noise voltage | $R_S = 20\ \Omega$ ,<br>See Figure 3   | 25°C  | f = 10 Hz to 10 kHz |        |     | 6         |        |     | $\mu\text{V}$          |     |
|   |  |   | f = 0.1 Hz to 10 Hz |        |     | 0.6       |        |     |                        |     |
| $I_n$ Equivalent input noise current                    | $V_{IC} = 0$ , f = 10 kHz  | 25°C  | 2.8                 |        |     | 2.8       |        |     | fA/ $\sqrt{\text{Hz}}$ |     |
| THD + N Total harmonic distortion plus noise            | $V_{O(PP)} = 5\text{ V}$ ,<br>f = 1 kHz,<br>$R_S = 25\ \Omega$   | $A_{VD} = 10$ ,<br>$R_L = 2\text{ k}\Omega$ | 25°C                | 0.013% |     |           | 0.013% |     |                        |     |
| $B_1$ Unity-gain bandwidth                              | $V_I = 10\text{ mV}$ ,<br>$C_L = 25\text{ pF}$   | $R_L = 2\text{ k}\Omega$ ,<br>See Figure 2  | 25°C                | 9.4    |     |           | 9.4    |     |                        | MHz |
| $B_{OM}$ Maximum output-swing bandwidth                 | $V_{O(PP)} = 4\text{ V}$ ,<br>$R_L = 2\text{ k}\Omega$   | $A_{VD} = -1$ ,<br>$C_L = 25\text{ pF}$     | 25°C                | 2.8    |     |           | 2.8    |     |                        | MHz |
| $\phi_m$ Phase margin at unity gain                     | $V_I = 10\text{ mV}$ ,<br>$C_L = 25\text{ pF}$   | $R_L = 2\text{ k}\Omega$ ,<br>See Figure 2  | 25°C                | 56°    |     |           | 56°    |     |                        |     |

\*On products compliant with MIL-PRF-38535, Class B, this parameter is not production tested.

† Full range is  $-55^\circ\text{C}$  to  $125^\circ\text{C}$ .

# TLE208x, TLE208xA, TLE208xY EXCALIBUR HIGH-SPEED JFET-INPUT OPERATIONAL AMPLIFIERS

SLOS182B – FEBRUARY 1997 – REVISED JUNE 2001

**TLE2082M electrical characteristics at specified free-air temperature,  $V_{CC\pm} = \pm 15\text{ V}$  (unless otherwise noted)**

| PARAMETER   | TEST CONDITIONS   | $T_A$ †                           | TLE2082M    |             |     | TLE2082AM   |             |                              | UNIT     |    |
|---|---|-----------------------------------|-------------|-------------|-----|-------------|-------------|------------------------------|----------|----|
|   |   |                                   | MIN         | TYP         | MAX | MIN         | TYP         | MAX                          |          |    |
| $V_{IO}$ Input offset voltage   | $V_{IC} = 0, V_O = 0, R_S = 50\ \Omega$                                       | 25°C                              | 1.1         | 7           |     | 0.7         | 4           | mV                           |          |    |
|   |   | Full range                        |             |             | 9.5 |             | 6.5         |                              |          |    |
| $\alpha_{VIO}$ Temperature coefficient of input offset voltage                |   | Full range                        | 2.4         | 25*         |     | 2.4         | 25*         | $\mu\text{V}/^\circ\text{C}$ |          |    |
| $I_{IO}$ Input offset current   | $V_{IC} = 0, V_O = 0, \text{See Figure 4}$                                    | 25°C                              | 6           | 100         |     | 6           | 100         | pA                           |          |    |
|   |   | Full range                        |             |             | 20  |             | 20          | nA                           |          |    |
| $I_{IB}$ Input bias current   |   | 25°C                              | 20          | 175         |     | 20          | 175         | pA                           |          |    |
|   |   | Full range                        |             |             | 65  |             | 65          | nA                           |          |    |
| $V_{ICR}$ Common-mode input voltage range                                     | $R_S = 50\ \Omega$  | 25°C                              | 15 to -11   | 15 to -11.9 |     | 15 to -11   | 15 to -11.9 | V                            |          |    |
|   |   | Full range                        | 15 to -10.8 |             |     | 15 to -10.8 |             |                              |          |    |
| $V_{OM+}$ Maximum positive peak output voltage swing                          | $I_O = -200\ \mu\text{A}$   | 25°C                              | 13.8        | 14.1        |     | 13.8        | 14.1        | V                            |          |    |
|   |   | Full range                        | 13.6        |             |     | 13.6        |             |                              |          |    |
|   | $I_O = -2\ \text{mA}$   | 25°C                              | 13.5        | 13.9        |     | 13.5        | 13.9        |                              |          |    |
|   |   | Full range                        | 13.3        |             |     | 13.3        |             |                              |          |    |
|   | $I_O = -20\ \text{mA}$  | 25°C                              | 11.5        | 12.3        |     | 11.5        | 12.3        |                              |          |    |
|   |   | Full range                        | 11.4        |             |     | 11.4        |             |                              |          |    |
| $V_{OM-}$ Maximum negative peak output voltage swing                          | $I_O = 200\ \mu\text{A}$  | 25°C                              | -13.8       | -14.2       |     | -13.8       | -14.2       | V                            |          |    |
|   |   | Full range                        | -13.6       |             |     | -13.6       |             |                              |          |    |
|   | $I_O = 2\ \text{mA}$  | 25°C                              | -13.5       | -14         |     | -13.5       | -14         |                              |          |    |
|   |   | Full range                        | -13.3       |             |     | -13.3       |             |                              |          |    |
|   | $I_O = 20\ \text{mA}$   | 25°C                              | -11.5       | -12.4       |     | -11.5       | -12.4       |                              |          |    |
|   |   | Full range                        | -11.4       |             |     | -11.4       |             |                              |          |    |
| $A_{VD}$ Large-signal differential voltage amplification                      | $V_O = \pm 10\ \text{V}$  | $R_L = 600\ \Omega$               | 25°C        | 80          | 96  |             | 80          | 96                           | dB       |    |
|   |   |                                   | Full range  | 78          |     |             | 78          |                              |          |    |
|   |   | $R_L = 2\ \text{k}\Omega$         | 25°C        | 90          | 109 |             | 90          | 109                          |          |    |
|   |   |                                   | Full range  | 88          |     |             | 88          |                              |          |    |
|   |   | $R_L = 10\ \text{k}\Omega$        | 25°C        | 95          | 118 |             | 95          | 118                          |          |    |
|   |   |                                   | Full range  | 93          |     |             | 93          |                              |          |    |
| $r_i$ Input resistance  | $V_{IC} = 0$  | 25°C                              | $10^{12}$   |             |     | $10^{12}$   |             |                              | $\Omega$ |    |
| $c_i$ Input capacitance   | Common mode   | $V_{IC} = 0, \text{See Figure 5}$ | 25°C        | 7.5         |     |             | 7.5         |                              |          | pF |
|   | Differential  |                                   | 25°C        | 2.5         |     |             | 2.5         |                              |          |    |
| $z_o$ Open-loop output impedance  | $f = 1\ \text{MHz}$   | 25°C                              | 80          |             |     | 80          |             |                              | $\Omega$ |    |
| CMRR Common-mode rejection ratio  | $V_{IC} = V_{ICRmin}, V_O = 0, R_S = 50\ \Omega$                              | 25°C                              | 80          | 98          |     | 80          | 98          | dB                           |          |    |
|   |   | Full range                        | 78          |             |     | 78          |             |                              |          |    |
| $k_{SVR}$ Supply-voltage rejection ratio ( $\Delta V_{CC\pm}/\Delta V_{IO}$ ) | $V_{CC\pm} = \pm 5\ \text{V to } \pm 15\ \text{V}, V_O = 0, R_S = 50\ \Omega$ | 25°C                              | 82          | 99          |     | 82          | 99          | dB                           |          |    |
|   |   | Full range                        | 80          |             |     | 80          |             |                              |          |    |

\*On products compliant with MIL-PRF-38535, Class B, this parameter is not production tested.

† Full range is  $-55^\circ\text{C}$  to  $125^\circ\text{C}$ .



**TLE208x, TLE208xA, TLE208xY**  
**EXCALIBUR HIGH-SPEED JFET-INPUT**  
**OPERATIONAL AMPLIFIERS**

SLOS182B – FEBRUARY 1997 – REVISED JUNE 2001

**TLE2082M electrical characteristics at specified free-air temperature,  $V_{CC\pm} = \pm 15$  V (unless otherwise noted) (continued)**

| PARAMETER | TEST CONDITIONS                | $T_A$ †                             | TLE2082M   |                 |     | TLE2082AM |     |     | UNIT |    |
|-----------|--------------------------------|-------------------------------------|------------|-----------------|-----|-----------|-----|-----|------|----|
|           |                                |                                     | MIN        | TYP             | MAX | MIN       | TYP | MAX |      |    |
| $I_{CC}$  | Supply current (both channels) | $V_O = 0$ , No load                 | 25°C       | 2.7             | 3.1 | 3.6       | 2.7 | 3.1 | 3.6  | mA |
|           |                                |                                     | Full range | 3.6             |     |           | 3.6 |     |      |    |
|           | Crosstalk attenuation          | $V_{IC} = 0$ , $R_L = 2$ k $\Omega$ | 25°C       | 120             |     |           | 120 |     |      | dB |
| $I_{OS}$  | Short-circuit output current   | $V_O = 0$                           | 25°C       | $V_{ID} = 1$ V  | -30 | -45       | -30 | -45 | mA   |    |
|           |                                |                                     |            | $V_{ID} = -1$ V | 30  | 48        | 30  | 48  |      |    |

† Full range is  $-55^\circ\text{C}$  to  $125^\circ\text{C}$ .

**TLE2082M operating characteristics at specified free-air temperature,  $V_{CC\pm} = \pm 15$  V**

| PARAMETER   | TEST CONDITIONS                             | $T_A$ †   | TLE2082M   |                     |      | TLE2082AM |        |            | UNIT                   |
|-------------|---|---|------------|---------------------|------|-----------|--------|------------|------------------------|
|             |   |   | MIN        | TYP                 | MAX  | MIN       | TYP    | MAX        |                        |
| SR+         | Positive slew rate                          | $V_{O(PP)} = 10$ V, $A_{VD} = -1$ , $R_L = 2$ k $\Omega$ , $C_L = 100$ pF, See Figure 1   | 25°C       | 28                  | 40   | 28        | 40     | V/ $\mu$ s |                        |
|             |   |   | Full range | 20                  |      |           | 20     |            |                        |
| SR-         | Negative slew rate                          | $V_{O(PP)} = 10$ V, $A_{VD} = -1$ , $R_L = 2$ k $\Omega$ , $C_L = 100$ pF, See Figure 1   | 25°C       | 30                  | 45   | 30        | 45     | V/ $\mu$ s |                        |
|             |   |   | Full range | 20                  |      |           | 20     |            |                        |
| $t_s$       | Settling time                               | $A_{VD} = -1$ , 10-V step, $R_L = 1$ k $\Omega$ , $C_L = 100$ pF                          | 25°C       | To 10 mV            | 0.4  |           | 0.4    |            | $\mu$ s                |
|             |   |   |            | To 1 mV             | 1.5  |           | 1.5    |            |                        |
| $V_n$       | Equivalent input noise voltage              | $R_S = 20$ $\Omega$ , See Figure 3  | 25°C       | f = 10 Hz           | 28   |           | 28     |            | nV/ $\sqrt{\text{Hz}}$ |
|             |   |   |            | f = 10 kHz          | 11.6 |           | 11.6   |            |                        |
| $V_{N(PP)}$ | Peak-to-peak equivalent input noise voltage | $R_S = 20$ $\Omega$ , See Figure 3  | 25°C       | f = 10 Hz to 10 kHz | 6    |           | 6      |            | $\mu$ V                |
|             |   |   |            | f = 0.1 Hz to 10 Hz | 0.6  |           | 0.6    |            |                        |
| $I_n$       | Equivalent input noise current              | $V_{IC} = 0$ , f = 10 kHz   | 25°C       | 2.8                 |      |           | 2.8    |            | fA/ $\sqrt{\text{Hz}}$ |
| THD + N     | Total harmonic distortion plus noise        | $V_{O(PP)} = 20$ V, $A_{VD} = 10$ , f = 1 kHz, $R_L = 2$ k $\Omega$ , $R_S = 25$ $\Omega$ | 25°C       | 0.008%              |      |           | 0.008% |            |                        |
| $B_1$       | Unity-gain bandwidth                        | $V_I = 10$ mV, $R_L = 2$ k $\Omega$ , $C_L = 25$ pF, See Figure 2                         | 25°C       | 8*                  | 10   | 8*        | 10     | MHz        |                        |
| BOM         | Maximum output-swing bandwidth              | $V_{O(PP)} = 20$ V, $A_{VD} = -1$ , $R_L = 2$ k $\Omega$ , $C_L = 25$ pF                  | 25°C       | 478*                | 637  | 478*      | 637    | kHz        |                        |
| $\phi_m$    | Phase margin at unity gain                  | $V_I = 10$ mV, $R_L = 2$ k $\Omega$ , $C_L = 25$ pF, See Figure 2                         | 25°C       | 57°                 |      |           | 57°    |            |                        |

\*On products compliant with MIL-PRF-38535, Class B, this parameter is not production tested.

† Full range is  $-55^\circ\text{C}$  to  $125^\circ\text{C}$ .



**TLE208x, TLE208xA, TLE208xY**  
**EXCALIBUR HIGH-SPEED JFET-INPUT**  
**OPERATIONAL AMPLIFIERS**

SLOS182B – FEBRUARY 1997 – REVISED JUNE 2001

**TLE2082Y electrical characteristics at  $V_{CC\pm} = \pm 15\text{ V}$ ,  $T_A = 25^\circ\text{C}$**

| PARAMETER |   | TEST CONDITIONS                                       |                            | TLE2082Y           |                  |          | UNIT |    |
|-----------|---|---|----------------------------|--------------------|------------------|----------|------|----|
|           |   |   |                            | MIN                | TYP              | MAX      |      |    |
| $V_{IO}$  | Input offset voltage  | $V_{IC} = 0$ ,  | $V_O = 0$ ,                | $R_S = 50\ \Omega$ | 1.1              | 6        | mV   |    |
| $I_{IO}$  | Input offset current  | $V_{IC} = 0$ ,  | $V_O = 0$ ,                | See Figure 4       | 6                | 100      | pA   |    |
| $I_{IB}$  | Input bias current  |   |                            |                    | 20               | 175      | pA   |    |
| $V_{ICR}$ | Common-mode input voltage range                                       | $R_S = 50\ \Omega$                                    |                            | 15<br>to<br>-11    | 15<br>to<br>11.9 |          | V    |    |
| $V_{OM+}$ | Maximum positive peak output voltage swing                            | $I_O = -200\ \mu\text{A}$                             |                            | 13.8               | 14.1             | V        |      |    |
|           |   | $I_O = -2\ \text{mA}$                                 |                            | 13.5               | 13.9             |          |      |    |
|           |   | $I_O = -20\ \text{mA}$                                |                            | 11.5               | 12.3             |          |      |    |
| $V_{OM-}$ | Maximum negative peak output voltage swing                            | $I_O = 200\ \mu\text{A}$                              |                            | -13.8              | -14.2            | V        |      |    |
|           |   | $I_O = 2\ \text{mA}$                                  |                            | -13.5              | -14              |          |      |    |
|           |   | $I_O = 20\ \text{mA}$                                 |                            | -11.5              | -12.4            |          |      |    |
| $A_{VD}$  | Large-signal differential voltage amplification                       | $V_O = \pm 10\ \text{V}$                              | $R_L = 600\ \Omega$        | 80                 | 96               | dB       |      |    |
|           |   |   | $R_L = 2\ \text{k}\Omega$  | 90                 | 109              |          |      |    |
|           |   |   | $R_L = 10\ \text{k}\Omega$ | 95                 | 118              |          |      |    |
| $r_i$     | Input resistance  | $V_{IC} = 0$  |                            | 10 <sup>12</sup>   |                  | $\Omega$ |      |    |
| $c_i$     | Input capacitance   | Common mode   | $V_O = 0$ ,                | See Figure 5       | 7.5              |          | pF   |    |
|           |   | Differential  |                            |                    | 2.5              |          |      |    |
| $z_o$     | Open-loop output impedance  | $f = 1\ \text{MHz}$                                   |                            | 80                 |                  | $\Omega$ |      |    |
| CMRR      | Common-mode rejection ratio   | $V_{IC} = V_{ICRmin}$ ,                               | $V_O = 0$ ,                | $R_S = 50\ \Omega$ | 80               | 98       | dB   |    |
| $k_{SVR}$ | Supply-voltage rejection ratio ( $\Delta V_{CC\pm} / \Delta V_{IO}$ ) | $V_{CC\pm} = \pm 5\ \text{V}$ to $\pm 15\ \text{V}$ , |                            | $V_O = 0$ ,        | 82               | 99       | dB   |    |
| $I_{CC}$  | Supply current (both channels)  | $V_O = 0$ ,   | No load                    |                    | 2.7              | 3.1      | 3.9  | mA |
| $I_{OS}$  | Short-circuit output current  | $V_O = 0$   | $V_{ID} = 1\ \text{V}$     | -30                | -45              | mA       |      |    |
|           |   |   | $V_{ID} = -1\ \text{V}$    | 30                 | 48               |          |      |    |



**TLE208x, TLE208xA, TLE208xY**  
**EXCALIBUR HIGH-SPEED JFET-INPUT**  
**OPERATIONAL AMPLIFIERS**

SLOS182B – FEBRUARY 1997 – REVISED JUNE 2001

**TLE2084C electrical characteristics at specified free-air temperature,  $V_{CC\pm} = \pm 5\text{ V}$  (unless otherwise noted)**

| PARAMETER   | TEST CONDITIONS   | $T_A$ †                    | TLE2084C   |           |           | TLE2084AC |           |           | UNIT                         |    |
|---|---|----------------------------|------------|-----------|-----------|-----------|-----------|-----------|------------------------------|----|
|   |   |                            | MIN        | TYP       | MAX       | MIN       | TYP       | MAX       |                              |    |
| $V_{IO}$ Input offset voltage   | $V_{IC} = 0,$<br>$V_O = 0,$<br>$R_S = 50\ \Omega$                                       | 25°C                       | -1.6       |           | 7         | -0.5      |           | 4         | mV                           |    |
|   |   | Full range                 |            |           | 9.1       |           |           | 6.1       |                              |    |
| $\alpha_{VIO}$ Temperature coefficient of input offset voltage                  |   | Full range                 | 10.1       |           | 30        | 10.1      |           | 30        | $\mu\text{V}/^\circ\text{C}$ |    |
| $I_{IO}$ Input offset current   | $V_{IC} = 0,$<br>$V_O = 0,$<br>See Figure 4   | 25°C                       | 15         |           | 100       | 15        |           | 100       | pA                           |    |
|   |   | Full range                 |            |           | 1.4       |           |           | 1.4       | nA                           |    |
| $I_{IB}$ Input bias current   |   | 25°C                       | 20         |           | 175       | 20        |           | 175       | pA                           |    |
|   |   | Full range                 |            |           | 5         |           |           | 5         | nA                           |    |
| $V_{ICR}$ Common-mode input voltage range                                       | $R_S = 50\ \Omega$  | 25°C                       | 5 to -1    | 5 to -1.9 |           | 5 to -1   | 5 to -1.9 |           | V                            |    |
|   |   | Full range                 | 5 to -0.9  |           |           | 5 to -0.9 |           |           |                              |    |
| $V_{OM+}$ Maximum positive peak output voltage swing                            | $I_O = -200\ \mu\text{A}$   | 25°C                       | 3.8        |           | 4.1       | 3.8       |           | 4.1       | V                            |    |
|   |   | Full range                 |            |           | 3.7       |           |           | 3.7       |                              |    |
|   | $I_O = -2\ \text{mA}$   | 25°C                       | 3.5        |           | 3.9       | 3.5       |           | 3.9       |                              |    |
|   |   | Full range                 |            |           | 3.4       |           |           | 3.4       |                              |    |
|   | $I_O = -20\ \text{mA}$  | 25°C                       | 1.5        |           | 2.3       | 1.5       |           | 2.3       |                              |    |
|   |   | Full range                 |            |           | 1.5       |           |           | 1.5       |                              |    |
| $V_{OM-}$ Maximum negative peak output voltage swing                            | $I_O = 200\ \mu\text{A}$  | 25°C                       | -3.8       |           | -4.2      | -3.8      |           | -4.2      | V                            |    |
|   |   | Full range                 |            |           | -3.7      |           |           | -3.7      |                              |    |
|   | $I_O = 2\ \text{mA}$  | 25°C                       | -3.5       |           | -4.1      | -3.5      |           | -4.1      |                              |    |
|   |   | Full range                 |            |           | -3.4      |           |           | -3.4      |                              |    |
|   | $I_O = 20\ \text{mA}$   | 25°C                       | -1.5       |           | -2.4      | -1.5      |           | -2.4      |                              |    |
|   |   | Full range                 |            |           | -1.5      |           |           | -1.5      |                              |    |
| $A_{VD}$ Large-signal differential voltage amplification                        | $V_O = \pm 2.3\ \text{V}$   | $R_L = 600\ \Omega$        | 25°C       | 80        |           | 91        | 80        |           | 91                           | dB |
|   |   |                            | Full range |           |           | 79        |           |           | 79                           |    |
|   |   | $R_L = 2\ \text{k}\Omega$  | 25°C       | 90        |           | 100       | 90        |           | 100                          |    |
|   |   |                            | Full range |           |           | 89        |           |           | 89                           |    |
|   |   | $R_L = 10\ \text{k}\Omega$ | 25°C       | 95        |           | 106       | 95        |           | 106                          |    |
|   |   |                            | Full range |           |           | 94        |           |           | 94                           |    |
| $r_i$ Input resistance  | $V_{IC} = 0$  | 25°C                       |            |           | $10^{12}$ |           |           | $10^{12}$ | $\Omega$                     |    |
| $c_i$ Input capacitance   | $V_{IC} = 0,$<br>See Figure 5   | Common mode                | 25°C       |           |           | 11        |           | 11        | pF                           |    |
|   |   | Differential               | 25°C       |           |           | 2.5       |           | 2.5       |                              |    |
| $z_o$ Open-loop output impedance  | $f = 1\ \text{MHz}$   | 25°C                       |            |           | 80        |           |           | 80        | $\Omega$                     |    |
| CMRR Common-mode rejection ratio  | $V_{IC} = V_{ICRmin},$<br>$V_O = 0,$<br>$R_S = 50\ \Omega$                              | 25°C                       | 70         |           | 89        | 70        |           | 89        | dB                           |    |
|   |   | Full range                 |            |           | 68        |           |           | 68        |                              |    |
| $k_{SVR}$ Supply-voltage rejection ratio ( $\Delta V_{CC\pm} / \Delta V_{IO}$ ) | $V_{CC\pm} = \pm 5\ \text{V to } \pm 15\ \text{V},$<br>$V_O = 0,$<br>$R_S = 50\ \Omega$ | 25°C                       | 82         |           | 99        | 82        |           | 99        | dB                           |    |
|   |   | Full range                 |            |           | 80        |           |           | 80        |                              |    |
| $I_{CC}$ Supply current (four amplifiers)                                       | $V_O = 0,$<br>No load   | 25°C                       | 5.2        | 6.3       | 7.5       | 5.2       | 6.3       | 7.5       | mA                           |    |
|   |   | Full range                 |            |           | 7.5       |           |           | 7.5       |                              |    |
| $a_x$ Crosstalk attenuation   | $V_{IC} = 0,$<br>$R_L = 2\ \text{k}\Omega$  | 25°C                       |            |           | 120       |           |           | 120       | dB                           |    |

† Full range is 0°C to 70°C.



**TLE208x, TLE208xA, TLE208xY**  
**EXCALIBUR HIGH-SPEED JFET-INPUT**  
**OPERATIONAL AMPLIFIERS**

SLOS182B – FEBRUARY 1997 – REVISED JUNE 2001

**TLE2084C electrical characteristics at specified free-air temperature,  $V_{CC\pm} = \pm 5\text{ V}$  (unless otherwise noted) (continued)**

| PARAMETER | TEST CONDITIONS                           | $T_A$ † | TLE2084C               |     |     | TLE2084AC |     |     | UNIT |
|-----------|---|---------|------------------------|-----|-----|-----------|-----|-----|------|
|           |   |         | MIN                    | TYP | MAX | MIN       | TYP | MAX |      |
| $I_{OS}$  | Short-circuit output current<br>$V_O = 0$ | 25°C    | $V_{ID} = 1\text{ V}$  |     |     | -35       |     |     | mA   |
|           |   |         | $V_{ID} = -1\text{ V}$ |     |     | 45        |     |     |      |

† Full range is 0°C to 70°C.

**TLE2084C operating characteristics at specified free-air temperature,  $V_{CC\pm} = \pm 5\text{ V}$**

| PARAMETER   | TEST CONDITIONS  | $T_A$ †    | TLE2084C            |     |     | TLE2084AC |     |     | UNIT                         |
|-------------|--|------------|---------------------|-----|-----|-----------|-----|-----|------------------------------|
|             |  |            | MIN                 | TYP | MAX | MIN       | TYP | MAX |                              |
| SR+         | Positive slew rate<br>$V_{O(PP)} = \pm 2.3\text{ V}$ ,<br>$A_{VD} = -1$ ,<br>$R_L = 2\text{ k}\Omega$ ,<br>$C_L = 100\text{ pF}$ ,<br>See Figure 1 | 25°C       | 35                  |     |     | 35        |     |     | $\text{V}/\mu\text{s}$       |
|             |  | Full range | 22                  |     |     | 22        |     |     |                              |
| SR-         | Negative slew rate   | 25°C       | 38                  |     |     | 38        |     |     | $\text{V}/\mu\text{s}$       |
|             |  | Full range | 22                  |     |     | 22        |     |     |                              |
| $t_s$       | Settling time<br>$A_{VD} = -1$ ,<br>2-V step,<br>$R_L = 1\text{ k}\Omega$ ,<br>$C_L = 100\text{ pF}$   | 25°C       | To 10 mV            |     |     | 0.25      |     |     | $\mu\text{s}$                |
|             |  |            | To 1 mV             |     |     | 0.4       |     |     |                              |
| $V_n$       | Equivalent input noise voltage<br>$R_S = 20\ \Omega$ ,<br>See Figure 3   | 25°C       | f = 10 Hz           |     |     | 28        |     |     | $\text{nV}/\sqrt{\text{Hz}}$ |
|             |  |            | f = 10 kHz          |     |     | 11.6      |     |     |                              |
| $V_{N(PP)}$ | Peak-to-peak equivalent input noise voltage  | 25°C       | f = 10 Hz to 10 kHz |     |     | 6         |     |     | $\mu\text{V}$                |
|             |  |            | f = 0.1 Hz to 10 Hz |     |     | 0.6       |     |     |                              |
| $I_n$       | Equivalent input noise current<br>$V_{IC} = 0$ , f = 10 kHz  | 25°C       | 2.8                 |     |     | 2.8       |     |     | $\text{fA}/\sqrt{\text{Hz}}$ |
| THD + N     | Total harmonic distortion plus noise<br>$V_{O(PP)} = 5\text{ V}$ ,<br>f = 1 kHz,<br>$R_S = 25\ \Omega$   | 25°C       | 0.013%              |     |     | 0.013%    |     |     |                              |
| $B_1$       | Unity-gain bandwidth<br>$V_I = 10\text{ mV}$ ,<br>$C_L = 25\text{ pF}$ ,<br>$R_L = 2\text{ k}\Omega$ ,<br>See Figure 2                             | 25°C       | 9.4                 |     |     | 9.4       |     |     | MHz                          |
| BOM         | Maximum output-swing bandwidth<br>$V_{O(PP)} = 4\text{ V}$ ,<br>$R_L = 2\text{ k}\Omega$ ,<br>$A_{VD} = -1$ ,<br>$C_L = 25\text{ pF}$              | 25°C       | 2.8                 |     |     | 2.8       |     |     | MHz                          |
| $\phi_m$    | Phase margin at unity gain<br>$V_I = 10\text{ mV}$ ,<br>$C_L = 25\text{ pF}$ ,<br>$R_L = 2\text{ k}\Omega$ ,<br>See Figure 2                       | 25°C       | 56°                 |     |     | 56°       |     |     |                              |

† Full range is 0°C to 70°C.



**TLE208x, TLE208xA, TLE208xY**  
**EXCALIBUR HIGH-SPEED JFET-INPUT**  
**OPERATIONAL AMPLIFIERS**

SLOS182B – FEBRUARY 1997 – REVISED JUNE 2001

**TLE2084C electrical characteristics at specified free-air temperature,  $V_{CC\pm} = \pm 15$  V (unless otherwise noted)**

| PARAMETER   | TEST CONDITIONS  | $T_A$ †                    | TLE2084C    |             |     | TLE2084AC   |             |                  | UNIT     |    |
|---|--|----------------------------|-------------|-------------|-----|-------------|-------------|------------------|----------|----|
|   |  |                            | MIN         | TYP         | MAX | MIN         | TYP         | MAX              |          |    |
| $V_{IO}$ Input offset voltage   | $V_{IC} = 0, V_O = 0, R_S = 50 \Omega$                                       | 25°C                       | -1.6        | 7           |     | -0.5        | 4           | mV               |          |    |
|   |  | Full range                 |             |             | 9.1 |             | 6.1         |                  |          |    |
| $\alpha_{VIO}$ Temperature coefficient of input offset voltage                |  | Full range                 | 10.1        | 30          |     | 10.1        | 30          | $\mu V/^\circ C$ |          |    |
| $I_{IO}$ Input offset current   | $V_{IC} = 0, V_O = 0, \text{See Figure 4}$                                   | 25°C                       | 15          | 100         |     | 15          | 100         | pA               |          |    |
|   |  | Full range                 |             |             | 1.4 |             | 1.4         | nA               |          |    |
| $I_{IB}$ Input bias current   |  | 25°C                       | 25          | 175         |     | 25          | 175         | pA               |          |    |
|   |  | Full range                 |             |             | 5   |             | 5           | nA               |          |    |
| $V_{ICR}$ Common-mode input voltage range                                     | $R_S = 50 \Omega$  | 25°C                       | 15 to -11   | 15 to -11.9 |     | 15 to -11   | 15 to -11.9 | V                |          |    |
|   |  | Full range                 | 15 to -10.9 |             |     | 15 to -10.9 |             |                  |          |    |
| $V_{OM+}$ Maximum positive peak output voltage swing                          | $I_O = -200 \mu A$   | 25°C                       | 13.8        | 14.1        |     | 13.8        | 14.1        | V                |          |    |
|   |  | Full range                 | 13.7        |             |     | 13.7        |             |                  |          |    |
|   | $I_O = -2 \text{ mA}$  | 25°C                       | 13.5        | 13.9        |     | 13.5        | 13.9        |                  |          |    |
|   |  | Full range                 | 13.4        |             |     | 13.4        |             |                  |          |    |
|   | $I_O = -20 \text{ mA}$   | 25°C                       | 11.5        | 12.3        |     | 11.5        | 12.3        |                  |          |    |
|   |  | Full range                 | 11.5        |             |     | 11.5        |             |                  |          |    |
| $V_{OM-}$ Maximum negative peak output voltage swing                          | $I_O = 200 \mu A$  | 25°C                       | -13.8       | -14.2       |     | -13.8       | -14.2       | V                |          |    |
|   |  | Full range                 | -13.7       |             |     | -13.7       |             |                  |          |    |
|   | $I_O = 2 \text{ mA}$   | 25°C                       | -13.7       | -14         |     | -13.7       | -14         |                  |          |    |
|   |  | Full range                 | -13.6       |             |     | -13.6       |             |                  |          |    |
|   | $I_O = 20 \text{ mA}$  | 25°C                       | -11.5       | -12.4       |     | -11.5       | -12.4       |                  |          |    |
|   |  | Full range                 | -11.5       |             |     | -11.5       |             |                  |          |    |
| $A_{VD}$ Large-signal differential voltage amplification                      | $V_O = \pm 10 \text{ V}$   | $R_L = 600 \Omega$         | 25°C        | 80          | 96  |             | 80          | 96               | dB       |    |
|   |  |                            | Full range  | 79          |     |             | 79          |                  |          |    |
|   |  | $R_L = 2 \text{ k}\Omega$  | 25°C        | 90          | 109 |             | 90          | 109              |          |    |
|   |  |                            | Full range  | 89          |     |             | 89          |                  |          |    |
|   |  | $R_L = 10 \text{ k}\Omega$ | 25°C        | 95          | 118 |             | 95          | 118              |          |    |
|   |  |                            | Full range  | 94          |     |             | 94          |                  |          |    |
| $r_i$ Input resistance  | $V_{IC} = 0$   | 25°C                       | $10^{12}$   |             |     | $10^{12}$   |             |                  | $\Omega$ |    |
| $c_i$ Input capacitance   | $V_{IC} = 0, \text{See Figure 5}$  | Common mode                | 25°C        | 7.5         |     |             | 7.5         |                  |          | pF |
|   |  | Differential               | 25°C        | 2.5         |     |             | 2.5         |                  |          |    |
| $z_o$ Open-loop output impedance  | $f = 1 \text{ MHz}$  | 25°C                       | 80          |             |     | 80          |             |                  | $\Omega$ |    |
| CMRR Common-mode rejection ratio  | $V_{IC} = V_{ICRmin}, V_O = 0, R_S = 50 \Omega$                              | 25°C                       | 80          | 98          |     | 80          | 98          | dB               |          |    |
|   |  | Full range                 | 79          |             |     | 79          |             |                  |          |    |
| $k_{SVR}$ Supply-voltage rejection ratio ( $\Delta V_{CC\pm}/\Delta V_{IO}$ ) | $V_{CC\pm} = \pm 5 \text{ V to } \pm 15 \text{ V}, V_O = 0, R_S = 50 \Omega$ | 25°C                       | 82          | 99          |     | 82          | 99          | dB               |          |    |
|   |  | Full range                 | 81          |             |     | 81          |             |                  |          |    |
| $I_{CC}$ Supply current (four amplifiers)                                     | $V_O = 0, \text{No load}$  | 25°C                       | 5.2         | 6.5         | 7.5 | 5.2         | 6.5         | 7.5              | mA       |    |
|   |  | Full range                 |             |             | 7.5 |             |             | 7.5              |          |    |
| $a_x$ Crosstalk attenuation   | $V_{IC} = 0, R_L = 2 \text{ k}\Omega$  | 25°C                       | 120         |             |     | 120         |             |                  | dB       |    |

† Full range is 0°C to 70°C.



# TLE208x, TLE208xA, TLE208xY EXCALIBUR HIGH-SPEED JFET-INPUT OPERATIONAL AMPLIFIERS

SLOS182B – FEBRUARY 1997 – REVISED JUNE 2001

**TLE2084C electrical characteristics at specified free-air temperature,  $V_{CC\pm} = \pm 15\text{ V}$  (unless otherwise noted) (continued)**

| PARAMETER | TEST CONDITIONS                           | $T_A$ † | TLE2084C               |     |     | TLE2084AC |     |     | UNIT |
|-----------|---|---------|------------------------|-----|-----|-----------|-----|-----|------|
|           |   |         | MIN                    | TYP | MAX | MIN       | TYP | MAX |      |
| $I_{OS}$  | Short-circuit output current<br>$V_O = 0$ | 25°C    | $V_{ID} = 1\text{ V}$  |     | -30 |           | -45 |     | mA   |
|           |   |         | $V_{ID} = -1\text{ V}$ |     | 30  |           | 48  |     |      |

† Full range is 0°C to 70°C.

**TLE2084C operating characteristics at specified free-air temperature,  $V_{CC\pm} = \pm 15\text{ V}$**

| PARAMETER   | TEST CONDITIONS                             | $T_A$ † | TLE2084C            |     |        | TLE2084AC |        |     | UNIT                   |
|-------------|---|---------|---------------------|-----|--------|-----------|--------|-----|------------------------|
|             |   |         | MIN                 | TYP | MAX    | MIN       | TYP    | MAX |                        |
| SR+         | Positive slew rate                          | 25°C    |                     |     | 25     |           | 40     |     | V/ $\mu$ s             |
|             |   |         | Full range          |     | 22     |           | 22     |     |                        |
| SR-         | Negative slew rate                          | 25°C    |                     |     | 30     |           | 45     |     | V/ $\mu$ s             |
|             |   |         | Full range          |     | 25     |           | 25     |     |                        |
| $t_s$       | Settling time                               | 25°C    | To 10 mV            |     | 0.4    |           | 0.4    |     | $\mu$ s                |
|             |   |         | To 1 mV             |     | 1.5    |           | 1.5    |     |                        |
| $V_n$       | Equivalent input noise voltage              | 25°C    | f = 10 Hz           |     | 28     |           | 28     |     | nV/ $\sqrt{\text{Hz}}$ |
|             |   |         | f = 10 kHz          |     | 11.6   |           | 11.6   |     |                        |
| $V_{N(PP)}$ | Peak-to-peak equivalent input noise voltage | 25°C    | f = 10 Hz to 10 kHz |     | 6      |           | 6      |     | $\mu$ V                |
|             |   |         | f = 0.1 Hz to 10 Hz |     | 0.6    |           | 0.6    |     |                        |
| $I_n$       | Equivalent input noise current              | 25°C    | f = 10 kHz          |     | 2.8    |           | 2.8    |     | fA/ $\sqrt{\text{Hz}}$ |
| THD + N     | Total harmonic distortion plus noise        | 25°C    | 0.008%              |     | 0.008% |           | 0.008% |     |                        |
| $B_1$       | Unity-gain bandwidth                        | 25°C    | 8                   |     | 10     |           | 8      |     | MHz                    |
| $B_{OM}$    | Maximum output-swing bandwidth              | 25°C    | 478                 |     | 637    |           | 478    |     | kHz                    |
| $\phi_m$    | Phase margin at unity gain                  | 25°C    | 57°                 |     | 57°    |           | 57°    |     |                        |

† Full range is 0°C to 70°C.



**TLE208x, TLE208xA, TLE208xY**  
**EXCALIBUR HIGH-SPEED JFET-INPUT**  
**OPERATIONAL AMPLIFIERS**

SLOS182B – FEBRUARY 1997 – REVISED JUNE 2001

**TLE2084M electrical characteristics at specified free-air temperature,  $V_{CC\pm} = \pm 5\text{ V}$  (unless otherwise noted)**

| PARAMETER   | TEST CONDITIONS   | $T_A$ †                    | TLE2084M   |           |      | TLE2084AM |           |                              | UNIT     |    |
|---|---|----------------------------|------------|-----------|------|-----------|-----------|------------------------------|----------|----|
|   |   |                            | MIN        | TYP       | MAX  | MIN       | TYP       | MAX                          |          |    |
| $V_{IO}$ Input offset voltage   | $V_{IC} = 0, V_O = 0,$<br>$R_S = 50\ \Omega$  | 25°C                       | -1.6       | 7         |      | -0.5      | 4         | mV                           |          |    |
|   |   | Full range                 |            |           | 12.5 |           | 9.5       |                              |          |    |
| $\alpha_{VIO}$ Temperature coefficient of input offset voltage                  |   | Full range                 | 10.1       | 30*       |      | 10.1      | 30*       | $\mu\text{V}/^\circ\text{C}$ |          |    |
| $I_{IO}$ Input offset current   | $V_{IC} = 0, V_O = 0,$<br>See Figure 4  | 25°C                       | 15         | 100       |      | 15        | 100       | pA                           |          |    |
|   |   | Full range                 |            |           | 20   |           | 20        | nA                           |          |    |
| $I_{IB}$ Input bias current   |   | 25°C                       | 20         | 175       |      | 20        | 175       | pA                           |          |    |
|   |   | Full range                 |            |           | 65   |           | 65        | nA                           |          |    |
| $V_{ICR}$ Common-mode input voltage range                                       | $R_S = 50\ \Omega$  | 25°C                       | 5 to -1    | 5 to -1.9 |      | 5 to -1   | 5 to -1.9 | V                            |          |    |
|   |   | Full range                 | 5 to -0.8  |           |      | 5 to -0.8 |           |                              |          |    |
| $V_{OM+}$ Maximum positive peak output voltage swing                            | $I_O = -200\ \mu\text{A}$   | 25°C                       | 3.8        | 4.1       |      | 3.8       | 4.1       | V                            |          |    |
|   |   | Full range                 | 3.6        |           |      | 3.6       |           |                              |          |    |
|   | $I_O = -2\ \text{mA}$   | 25°C                       | 3.5        | 3.9       |      | 3.5       | 3.9       |                              |          |    |
|   |   | Full range                 | 3.3        |           |      | 3.3       |           |                              |          |    |
|   | $I_O = -20\ \text{mA}$  | 25°C                       | 1.5        | 2.3       |      | 1.5       | 2.3       |                              |          |    |
|   |   | Full range                 | 1.4        |           |      | 1.4       |           |                              |          |    |
| $V_{OM-}$ Maximum negative peak output voltage swing                            | $I_O = 200\ \mu\text{A}$  | 25°C                       | -3.8       | -4.2      |      | -3.8      | -4.2      | V                            |          |    |
|   |   | Full range                 | -3.6       |           |      | -3.6      |           |                              |          |    |
|   | $I_O = 2\ \text{mA}$  | 25°C                       | -3.5       | -4.1      |      | -3.5      | -4.1      |                              |          |    |
|   |   | Full range                 | -3.3       |           |      | -3.3      |           |                              |          |    |
|   | $I_O = 20\ \text{mA}$   | 25°C                       | -1.5       | -2.4      |      | -1.5      | -2.4      |                              |          |    |
|   |   | Full range                 | -1.4       |           |      | -1.4      |           |                              |          |    |
| $A_{VD}$ Large-signal differential voltage amplification                        | $V_O = \pm 2.3\ \text{V}$   | $R_L = 600\ \Omega$        | 25°C       | 80        | 91   |           | 80        | 91                           | dB       |    |
|   |   |                            | Full range | 78        |      |           | 78        |                              |          |    |
|   |   | $R_L = 2\ \text{k}\Omega$  | 25°C       | 90        | 100  |           | 90        | 100                          |          |    |
|   |   |                            | Full range | 88        |      |           | 88        |                              |          |    |
|   |   | $R_L = 10\ \text{k}\Omega$ | 25°C       | 95        | 106  |           | 95        | 106                          |          |    |
|   |   |                            | Full range | 93        |      |           | 93        |                              |          |    |
| $r_i$ Input resistance  | $V_{IC} = 0$  | 25°C                       | $10^{12}$  |           |      | $10^{12}$ |           |                              | $\Omega$ |    |
| $c_i$ Input capacitance   | $V_{IC} = 0,$<br>See Figure 5   | Common mode                | 25°C       | 11        |      |           | 11        |                              |          | pF |
|   |   | Differential               | 25°C       | 2.5       |      |           | 2.5       |                              |          |    |
| $z_o$ Open-loop output impedance  | $f = 1\ \text{MHz}$   | 25°C                       | 80         |           |      | 80        |           |                              | $\Omega$ |    |
| CMRR Common-mode rejection ratio  | $V_{IC} = V_{ICRmin},$<br>$V_O = 0, R_S = 50\ \Omega$                               | 25°C                       | 70         | 89        |      | 70        | 89        | dB                           |          |    |
|   |   | Full range                 | 68         |           |      | 68        |           |                              |          |    |
| $k_{SVR}$ Supply-voltage rejection ratio ( $\Delta V_{CC\pm} / \Delta V_{IO}$ ) | $V_{CC\pm} = \pm 5\ \text{V}$ to $\pm 15\ \text{V},$<br>$V_O = 0, R_S = 50\ \Omega$ | 25°C                       | 82         | 99        |      | 82        | 99        | dB                           |          |    |
|   |   | Full range                 | 80         |           |      | 80        |           |                              |          |    |
| $I_{CC}$ Supply current (four amplifiers)                                       | $V_O = 0,$ No load  | 25°C                       | 5.2        | 6.3       | 7.5  | 5.2       | 6.3       | 7.5                          | mA       |    |
|   |   | Full range                 |            |           | 7.5  |           |           | 7.5                          |          |    |
| $a_x$ Crosstalk attenuation   | $V_{IC} = 0, R_L = 2\ \text{k}\Omega$   | 25°C                       | 120        |           |      | 120       |           |                              | dB       |    |

\*On products compliant with MIL-PRF-38535, Class B, this parameter is not production tested.

† Full range is  $-55^\circ\text{C}$  to  $125^\circ\text{C}$ .



# TLE208x, TLE208xA, TLE208xY EXCALIBUR HIGH-SPEED JFET-INPUT OPERATIONAL AMPLIFIERS

SLOS182B – FEBRUARY 1997 – REVISED JUNE 2001

**TLE2084M electrical characteristics at specified free-air temperature,  $V_{CC\pm} = \pm 5\text{ V}$  (unless otherwise noted) (continued)**

| PARAMETER | TEST CONDITIONS                           | $T_A$ | TLE2084M               |     |     | TLE2084AM |     |     | UNIT |
|-----------|---|-------|------------------------|-----|-----|-----------|-----|-----|------|
|           |   |       | MIN                    | TYP | MAX | MIN       | TYP | MAX |      |
| $I_{OS}$  | Short-circuit output current<br>$V_O = 0$ | 25°C  | $V_{ID} = 1\text{ V}$  |     |     | -35       |     |     | mA   |
|           |   |       | $V_{ID} = -1\text{ V}$ |     |     | 45        |     |     |      |

**TLE2084M operating characteristics at specified free-air temperature,  $V_{CC\pm} = \pm 5\text{ V}$**

| PARAMETER   | TEST CONDITIONS                             | $T_A$ † | TLE2084M            |     |     | TLE2084AM |     |     | UNIT                   |
|-------------|---|---------|---------------------|-----|-----|-----------|-----|-----|------------------------|
|             |   |         | MIN                 | TYP | MAX | MIN       | TYP | MAX |                        |
| SR+         | Positive slew rate                          | 25°C    | 35                  |     |     | 35        |     |     | V/ $\mu$ s             |
|             |   |         | Full range          |     |     | 18*       |     |     |                        |
| SR-         | Negative slew rate                          | 25°C    | 38                  |     |     | 38        |     |     | V/ $\mu$ s             |
|             |   |         | Full range          |     |     | 18*       |     |     |                        |
| $t_s$       | Settling time                               | 25°C    | To 10 mV            |     |     | 0.25      |     |     | $\mu$ s                |
|             |   |         | To 1 mV             |     |     | 0.4       |     |     |                        |
| $V_n$       | Equivalent input noise voltage              | 25°C    | f = 10 Hz           |     |     | 28        |     |     | nV/ $\sqrt{\text{Hz}}$ |
|             |   |         | f = 10 kHz          |     |     | 11.6      |     |     |                        |
| $V_{N(PP)}$ | Peak-to-peak equivalent input noise voltage | 25°C    | f = 10 Hz to 10 kHz |     |     | 6         |     |     | $\mu$ V                |
|             |   |         | f = 0.1 Hz to 10 Hz |     |     | 0.6       |     |     |                        |
| $I_n$       | Equivalent input noise current              | 25°C    | 2.8                 |     |     | 2.8       |     |     | fA/ $\sqrt{\text{Hz}}$ |
| THD + N     | Total harmonic distortion plus noise        | 25°C    | 0.013%              |     |     | 0.013%    |     |     |                        |
| $B_1$       | Unity-gain bandwidth                        | 25°C    | 9.4                 |     |     | 9.4       |     |     | MHz                    |
| BOM         | Maximum output-swing bandwidth              | 25°C    | 2.8                 |     |     | 2.8       |     |     | MHz                    |
| $\phi_m$    | Phase margin at unity gain                  | 25°C    | 56°                 |     |     | 56°       |     |     |                        |

\*On products compliant with MIL-PRF-38535, Class B, this parameter is not production tested.

† Full range is -55°C to 125°C.



**TLE208x, TLE208xA, TLE208xY**  
**EXCALIBUR HIGH-SPEED JFET-INPUT**  
**OPERATIONAL AMPLIFIERS**

SLOS182B – FEBRUARY 1997 – REVISED JUNE 2001

**TLE2084M electrical characteristics at specified free-air temperature,  $V_{CC\pm} = \pm 15$  V (unless otherwise noted)**

| PARAMETER   | TEST CONDITIONS  | $T_A$ †                    | TLE2084M    |             |      | TLE2084AM   |             |                  | UNIT     |    |
|---|--|----------------------------|-------------|-------------|------|-------------|-------------|------------------|----------|----|
|   |  |                            | MIN         | TYP         | MAX  | MIN         | TYP         | MAX              |          |    |
| $V_{IO}$ Input offset voltage   | $V_{IC} = 0, V_O = 0, R_S = 50 \Omega$                                       | 25°C                       | -1.6        | 7           |      | -0.5        | 4           | mV               |          |    |
|   |  | Full range                 |             |             | 12.5 |             | 7.5         |                  |          |    |
| $\alpha_{VIO}$ Temperature coefficient of input offset voltage                |  | Full range                 | 10.1        | 30*         |      | 10.1        | 30*         | $\mu V/^\circ C$ |          |    |
| $I_{IO}$ Input offset current   | $V_{IC} = 0, V_O = 0, \text{See Figure 4}$                                   | 25°C                       | 15          | 100         |      | 15          | 100         | pA               |          |    |
|   |  | Full range                 |             |             | 20   |             | 20          | nA               |          |    |
| $I_{IB}$ Input bias current   |  | 25°C                       | 25          | 175         |      | 25          | 175         | pA               |          |    |
|   |  | Full range                 |             |             | 65   |             | 65          | nA               |          |    |
| $V_{ICR}$ Common-mode input voltage range                                     | $R_S = 50 \Omega$  | 25°C                       | 15 to -11   | 15 to -11.9 |      | 15 to -11   | 15 to -11.9 | V                |          |    |
|   |  | Full range                 | 15 to -10.8 |             |      | 15 to -10.8 |             |                  |          |    |
| $V_{OM+}$ Maximum positive peak output voltage swing                          | $I_O = -200 \mu A$   | 25°C                       | 13.8        | 14.1        |      | 13.8        | 14.1        | V                |          |    |
|   |  | Full range                 | 13.6        |             |      | 13.6        |             |                  |          |    |
|   | $I_O = -2 \text{ mA}$  | 25°C                       | 13.5        | 13.9        |      | 13.5        | 13.9        |                  |          |    |
|   |  | Full range                 | 13.3        |             |      | 13.3        |             |                  |          |    |
|   | $I_O = -20 \text{ mA}$   | 25°C                       | 11.5        | 12.3        |      | 11.5        | 12.3        |                  |          |    |
|   |  | Full range                 | 11.4        |             |      | 11.4        |             |                  |          |    |
| $V_{OM-}$ Maximum negative peak output voltage swing                          | $I_O = 200 \mu A$  | 25°C                       | -13.8       | -14.2       |      | -13.8       | -14.2       | V                |          |    |
|   |  | Full range                 | -13.6       |             |      | -13.6       |             |                  |          |    |
|   | $I_O = 2 \text{ mA}$   | 25°C                       | -13.5       | -14         |      | -13.5       | -14         |                  |          |    |
|   |  | Full range                 | -13.3       |             |      | -13.3       |             |                  |          |    |
|   | $I_O = 20 \text{ mA}$  | 25°C                       | -11.5       | -12.4       |      | -11.5       | -12.4       |                  |          |    |
|   |  | Full range                 | -11.4       |             |      | -11.4       |             |                  |          |    |
| $A_{VD}$ Large-signal differential voltage amplification                      | $V_O = \pm 10 \text{ V}$   | $R_L = 600 \Omega$         | 25°C        | 80          | 96   |             | 80          | 96               | dB       |    |
|   |  |                            | Full range  | 78          |      |             | 78          |                  |          |    |
|   |  | $R_L = 2 \text{ k}\Omega$  | 25°C        | 90          | 109  |             | 90          | 109              |          |    |
|   |  |                            | Full range  | 88          |      |             | 88          |                  |          |    |
|   |  | $R_L = 10 \text{ k}\Omega$ | 25°C        | 95          | 118  |             | 95          | 118              |          |    |
|   |  |                            | Full range  | 93          |      |             | 93          |                  |          |    |
| $r_i$ Input resistance  | $V_{IC} = 0$   | 25°C                       | $10^{12}$   |             |      | $10^{12}$   |             |                  | $\Omega$ |    |
| $c_i$ Input capacitance   | $V_{IC} = 0, \text{See Figure 5}$  | Common mode                | 25°C        | 7.5         |      |             | 7.5         |                  |          | pF |
|   |  | Differential               | 25°C        | 2.5         |      |             | 2.5         |                  |          |    |
| $z_o$ Open-loop output impedance  | $f = 1 \text{ MHz}$  | 25°C                       | 80          |             |      | 80          |             |                  | $\Omega$ |    |
| CMRR Common-mode rejection ratio  | $V_{IC} = V_{ICRmin}, V_O = 0, R_S = 50 \Omega$                              | 25°C                       | 80          | 98          |      | 80          | 98          | dB               |          |    |
|   |  | Full range                 | 78          |             |      | 78          |             |                  |          |    |
| $k_{SVR}$ Supply-voltage rejection ratio ( $\Delta V_{CC\pm}/\Delta V_{IO}$ ) | $V_{CC\pm} = \pm 5 \text{ V to } \pm 15 \text{ V}, V_O = 0, R_S = 50 \Omega$ | 25°C                       | 82          | 99          |      | 82          | 99          | dB               |          |    |
|   |  | Full range                 | 80          |             |      | 80          |             |                  |          |    |
| $I_{CC}$ Supply current (four amplifiers)                                     | $V_O = 0, \text{No load}$  | 25°C                       | 5.2         | 6.5         | 7.5  | 5.2         | 6.5         | 7.5              | mA       |    |
|   |  | Full range                 |             |             | 7.5  |             |             | 7.5              |          |    |
| $a_x$ Crosstalk attenuation   | $V_{IC} = 0, R_L = 2 \text{ k}\Omega$  | 25°C                       | 120         |             |      | 120         |             |                  | dB       |    |

\*On products compliant with MIL-PRF-38535, Class B, this parameter is not production tested.

† Full range is  $-55^\circ C$  to  $125^\circ C$ .



**TLE208x, TLE208xA, TLE208xY**  
**EXCALIBUR HIGH-SPEED JFET-INPUT**  
**OPERATIONAL AMPLIFIERS**

SLOS182B – FEBRUARY 1997 – REVISED JUNE 2001

**TLE2084M electrical characteristics at specified free-air temperature,  $V_{CC\pm} = \pm 15\text{ V}$  (unless otherwise noted) (continued)**

| PARAMETER | TEST CONDITIONS                           | $T_A$ | TLE2084M               |     |     | TLE2084AM              |     |     | UNIT |
|-----------|---|-------|------------------------|-----|-----|------------------------|-----|-----|------|
|           |   |       | MIN                    | TYP | MAX | MIN                    | TYP | MAX |      |
| $I_{OS}$  | Short-circuit output current<br>$V_O = 0$ | 25°C  | $V_{ID} = 1\text{ V}$  |     |     | $V_{ID} = 1\text{ V}$  |     |     | mA   |
|           |   |       | $V_{ID} = -1\text{ V}$ |     |     | $V_{ID} = -1\text{ V}$ |     |     |      |

**TLE2084M operating characteristics at specified free-air temperature,  $V_{CC\pm} = \pm 15\text{ V}$**

| PARAMETER   | TEST CONDITIONS                             | $T_A$ † | TLE2084M            |     |      | TLE2084AM           |     |     | UNIT                  |
|-------------|---|---------|---------------------|-----|------|---------------------|-----|-----|-----------------------|
|             |   |         | MIN                 | TYP | MAX  | MIN                 | TYP | MAX |                       |
| SR+         | Positive slew rate                          | 25°C    | Full range          |     |      | Full range          |     |     | $V/\mu\text{s}$       |
|             |   |         | 25                  |     |      | 40                  |     |     |                       |
| SR-         | Negative slew rate                          | 25°C    | Full range          |     |      | Full range          |     |     | $V/\mu\text{s}$       |
|             |   |         | 30                  |     |      | 45                  |     |     |                       |
| $t_s$       | Settling time                               | 25°C    | To 10 mV            |     |      | To 10 mV            |     |     | $\mu\text{s}$         |
|             |   |         | To 1 mV             |     |      | To 1 mV             |     |     |                       |
| $V_n$       | Equivalent input noise voltage              | 25°C    | f = 10 Hz           |     |      | f = 10 Hz           |     |     | $nV/\sqrt{\text{Hz}}$ |
|             |   |         | f = 10 kHz          |     |      | f = 10 kHz          |     |     |                       |
| $V_{N(PP)}$ | Peak-to-peak equivalent input noise voltage | 25°C    | f = 10 Hz to 10 kHz |     |      | f = 10 Hz to 10 kHz |     |     | $\mu\text{V}$         |
|             |   |         | f = 0.1 Hz to 10 Hz |     |      | f = 0.1 Hz to 10 Hz |     |     |                       |
| $I_n$       | Equivalent input noise current              | 25°C    | f = 10 kHz          |     |      | f = 10 kHz          |     |     | $fA/\sqrt{\text{Hz}}$ |
| THD + N     | Total harmonic distortion plus noise        | 25°C    | 0.008%              |     |      | 0.008%              |     |     |                       |
| $B_1$       | Unity-gain bandwidth                        | 25°C    | 8*                  | 10  | 8*   | 10                  |     | MHz |                       |
| $B_{OM}$    | Maximum output-swing bandwidth              | 25°C    | 478*                | 637 | 478* | 637                 |     | kHz |                       |
| $\phi_m$    | Phase margin at unity gain                  | 25°C    | 57°                 |     |      | 57°                 |     |     |                       |

\*On products compliant with MIL-PRF-38535, Class B, this parameter is not production tested.

† Full range is  $-55^\circ\text{C}$  to  $125^\circ\text{C}$ .



**TLE208x, TLE208xA, TLE208xY**  
**EXCALIBUR HIGH-SPEED JFET-INPUT**  
**OPERATIONAL AMPLIFIERS**

SLOS182B – FEBRUARY 1997 – REVISED JUNE 2001

**TLE2084Y electrical characteristics at  $V_{CC\pm} = \pm 15\text{ V}$ ,  $T_A = 25^\circ\text{C}$  (unless otherwise noted)**

| PARAMETER |   | TEST CONDITIONS   |                            | TLE2084Y         |                  |     | UNIT     |
|-----------|---|---|----------------------------|------------------|------------------|-----|----------|
|           |   |   |                            | MIN              | TYP              | MAX |          |
| $V_{IO}$  | Input offset voltage  | $V_{IC} = 0$ ,<br>$R_S = 50\ \Omega$  | $V_O = 0$ ,                |                  |                  | 7   | mV       |
| $I_{IO}$  | Input offset current  | $V_{IC} = 0$ ,  | $V_O = 0$ ,                |                  | 15               | 100 | pA       |
| $I_{IB}$  | Input bias current  | See Figure 4  |                            |                  | 25               | 175 | pA       |
| $V_{ICR}$ | Common-mode input voltage range                                       | $R_S = 50\ \Omega$  |                            | 15<br>to<br>-11  | 15<br>to<br>11.9 |     | V        |
| $V_{OM+}$ | Maximum positive peak output voltage swing                            | $I_O = -200\ \mu\text{A}$   |                            | 13.8             | 14.1             |     | V        |
|           |   | $I_O = -2\ \text{mA}$   |                            | 13.5             | 13.9             |     |          |
|           |   | $I_O = -20\ \text{mA}$  |                            | 11.5             | 12.3             |     |          |
| $V_{OM-}$ | Maximum negative peak output voltage swing                            | $I_O = 200\ \mu\text{A}$  |                            | -13.8            | -14.2            |     | V        |
|           |   | $I_O = 2\ \text{mA}$  |                            | -13.5            | -14              |     |          |
|           |   | $I_O = 20\ \text{mA}$   |                            | -11.5            | -12.4            |     |          |
| $A_{VD}$  | Large-signal differential voltage amplification                       | $V_O = \pm 10\ \text{V}$  | $R_L = 600\ \Omega$        | 80               | 96               |     | dB       |
|           |   |   | $R_L = 2\ \text{k}\Omega$  | 90               | 109              |     |          |
|           |   |   | $R_L = 10\ \text{k}\Omega$ | 95               | 118              |     |          |
| $r_i$     | Input resistance  | $V_{IC} = 0$  |                            | 10 <sup>12</sup> |                  |     | $\Omega$ |
| $c_i$     | Input capacitance   | $V_{IC} = 0$ ,<br>See Figure 5  | Common mode                | 7.5              |                  |     | pF       |
|           |   |   | Differential               | 2.5              |                  |     |          |
| $z_o$     | Open-loop output impedance  | $f = 1\ \text{MHz}$   |                            | 80               |                  |     | $\Omega$ |
| CMRR      | Common-mode rejection ratio   | $V_{IC} = V_{ICRmin}$ ,<br>$R_S = 50\ \Omega$   | $V_O = 0$ ,                | 80               | 98               |     | dB       |
| $k_{SVR}$ | Supply-voltage rejection ratio ( $\Delta V_{CC\pm} / \Delta V_{IO}$ ) | $V_{CC\pm} = \pm 5\ \text{V}$ to $\pm 15\ \text{V}$ , $V_O = 0$ ,<br>$R_S = 50\ \Omega$ |                            | 82               | 99               |     | dB       |
| $I_{CC}$  | Supply current (four amplifiers)                                      | $V_O = 0$ ,   | No load                    | 5.2              | 6.5              | 7.5 | mA       |
| $I_{OS}$  | Short-circuit output current  | $V_O = 0$   | $V_{ID} = 1\ \text{V}$     | -30              | -45              |     | mA       |
|           |   |   | $V_{ID} = -1\ \text{V}$    | 30               | 48               |     |          |



# TLE208x, TLE208xA, TLE208xY EXCALIBUR HIGH-SPEED JFET-INPUT OPERATIONAL AMPLIFIERS

SLOS182B – FEBRUARY 1997 – REVISED JUNE 2001

## PARAMETER MEASUREMENT INFORMATION

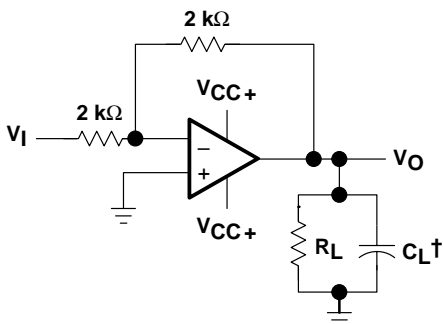

† Includes fixture capacitance

**Figure 1. Slew-Rate Test Circuit**

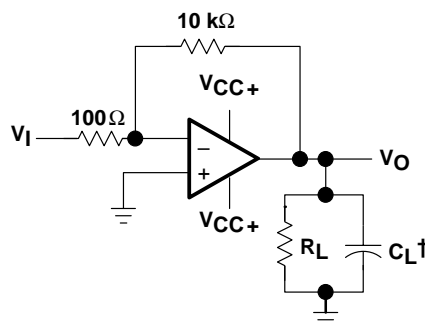

† Includes fixture capacitance

**Figure 2. Unity-Gain Bandwidth and Phase-Margin Test Circuit**

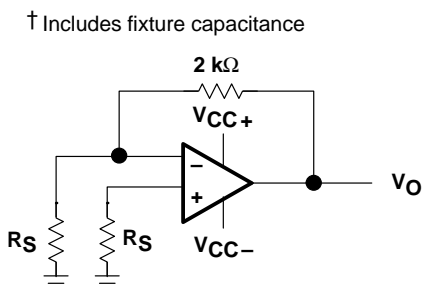

† Includes fixture capacitance

**Figure 3. Noise-Voltage Test Circuit**

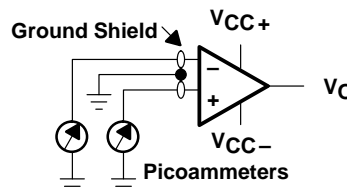

**Figure 4. Input-Bias and Offset-Current Test Circuit**

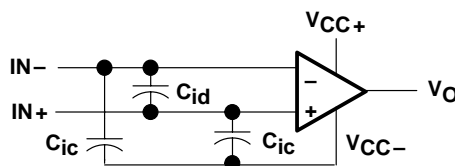

**Figure 5. Internal Input Capacitance**

### typical values

Typical values presented in this data sheet represent the median (50% point) of device parametric performance.

### input bias and offset current

At the picoampere bias-current level typical of the TLE208x and TLE208xA, accurate measurement of the bias becomes difficult. Not only does this measurement require a picoammeter, but test socket leakages can easily exceed the actual device bias currents. To accurately measure these small currents, Texas Instruments uses a two-step process. The socket leakage is measured using picoammeters with bias voltages applied but with no device in the socket. The device is then inserted in the socket and a second test is performed that measures both the socket leakage and the device input bias current. The two measurements are then subtracted algebraically to determine the bias current of the device.

## TYPICAL CHARACTERISTICS

**Table of Graphs**

|                |   |  | FIGURE                              |
|----------------|---|--|-------------------------------------|
| $V_{IO}$       | Input offset voltage                            | Distribution   | 6, 7, 8                             |
| $\alpha_{VIO}$ | Input offset voltage temperature coefficient    | Distribution   | 9, 10, 11                           |
| $I_{IO}$       | Input offset current                            | vs Free-air temperature  | 12 – 15                             |
| $I_{IB}$       | Input bias current                              | vs Free-air temperature<br>vs Supply voltage                                   | 12 – 15<br>16                       |
| $V_{ICR}$      | Common-mode input voltage range                 | vs Free-air temperature  | 17                                  |
| $V_{ID}$       | Differential input voltage                      | vs Output voltage  | 18, 19                              |
| $V_{OM+}$      | Maximum positive peak output voltage            | vs Output current<br>vs Free-air temperature<br>vs Supply voltage              | 20, 21<br>24, 25<br>26              |
| $V_{OM-}$      | Maximum negative peak output voltage            | vs Output current<br>vs Free-air temperature<br>vs Supply voltage              | 22, 23<br>24, 25<br>26              |
| $V_{O(PP)}$    | Maximum peak-to-peak output voltage             | vs Frequency   | 27                                  |
| $V_O$          | Output voltage                                  | vs Settling time   | 28                                  |
| $A_{VD}$       | Large-signal differential voltage amplification | vs Load resistance<br>vs Free-air temperature                                  | 29<br>30, 31                        |
| $A_{VD}$       | Small-signal differential voltage amplification | vs Frequency   | 32, 33                              |
| $CMRR$         | Common-mode rejection ratio                     | vs Frequency<br>vs Free-air temperature  | 34<br>35                            |
| $k_{SVR}$      | Supply-voltage rejection ratio                  | vs Frequency<br>vs Free-air temperature  | 36<br>37                            |
| $I_{CC}$       | Supply current                                  | vs Supply voltage<br>vs Free-air temperature<br>vs Differential input voltage  | 38, 39, 40<br>41, 42, 43<br>44 – 49 |
| $I_{OS}$       | Short-circuit output current                    | vs Supply voltage<br>vs Elapsed time<br>vs Free-air temperature                | 50<br>51<br>52                      |
| $SR$           | Slew rate                                       | vs Free-air temperature<br>vs Load resistance<br>vs Differential input voltage | 53, 54<br>55<br>56                  |
| $V_n$          | Equivalent input noise voltage                  | vs Frequency   | 57                                  |
| $V_n$          | Input-referred noise voltage                    | vs Noise bandwidth frequency<br>Over a 10-second time interval                 | 58<br>59                            |
|                | Third-octave spectral noise density             | vs Frequency bands   | 60                                  |
| $THD + N$      | Total harmonic distortion plus noise            | vs Frequency   | 61, 62                              |
| $B_1$          | Unity-gain bandwidth                            | vs Load capacitance  | 63                                  |
|                | Gain-bandwidth product                          | vs Free-air temperature<br>vs Supply voltage                                   | 64<br>65                            |
|                | Gain margin                                     | vs Load capacitance  | 66                                  |
| $\phi_m$       | Phase margin                                    | vs Free-air temperature<br>vs Supply voltage<br>vs Load capacitance            | 67<br>68<br>69                      |
|                | Phase shift                                     | vs Frequency   | 32, 33                              |

**TLE208x, TLE208xA, TLE208xY**  
**EXCALIBUR HIGH-SPEED JFET-INPUT**  
**OPERATIONAL AMPLIFIERS**

SLOS182B – FEBRUARY 1997 – REVISED JUNE 2001

**TYPICAL CHARACTERISTICS**

**Table of Graphs (Continued)**

|  |   | FIGURE |
|--|---|--------|
| Noninverting large-signal pulse response | vs Time                                   | 70     |
| Small-signal pulse response              | vs Time                                   | 71     |
| $z_o$                                    | Closed-loop output impedance vs Frequency | 72     |
| $a_x$                                    | Crosstalk attenuation vs Frequency        | 73     |

**DISTRIBUTION OF TLE2081  
INPUT OFFSET VOLTAGE**

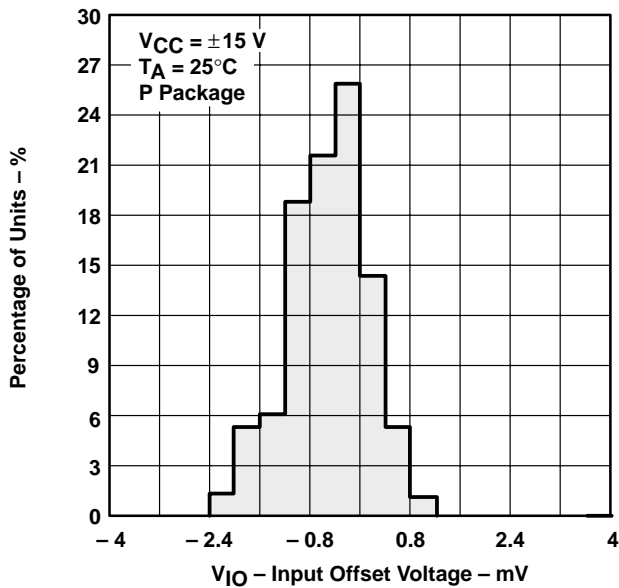

**Figure 6**

**DISTRIBUTION OF TLE2082  
INPUT OFFSET VOLTAGE**

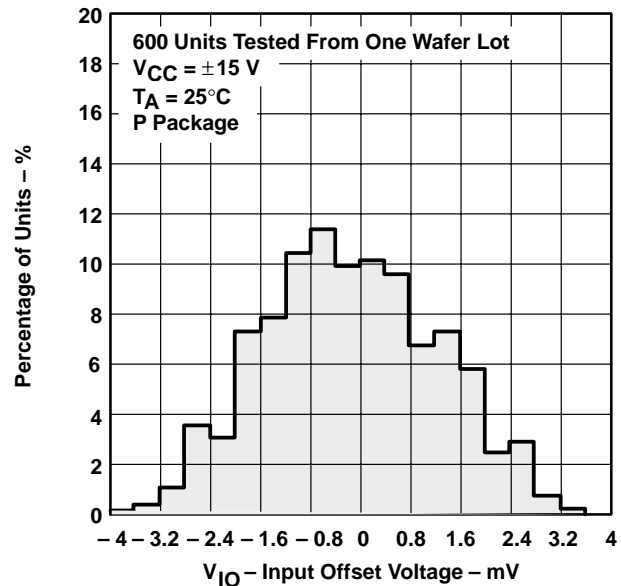

**Figure 7**

TYPICAL CHARACTERISTICS

DISTRIBUTION OF TLE2084  
INPUT OFFSET VOLTAGE

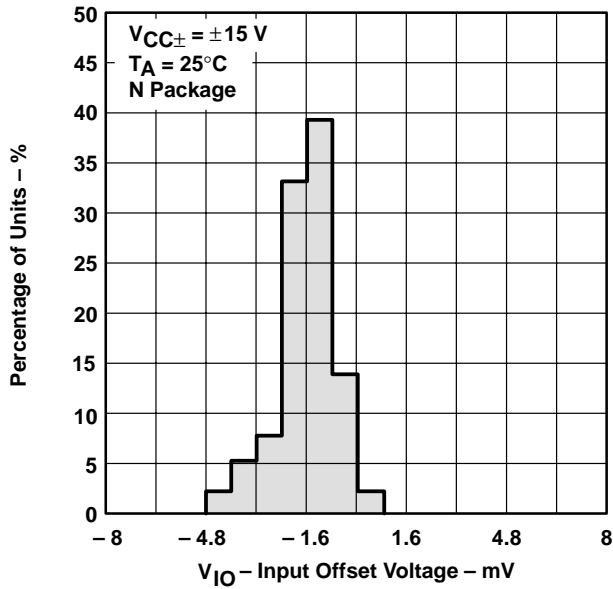

Figure 8

DISTRIBUTION OF TLE2081 INPUT OFFSET  
VOLTAGE TEMPERATURE COEFFICIENT

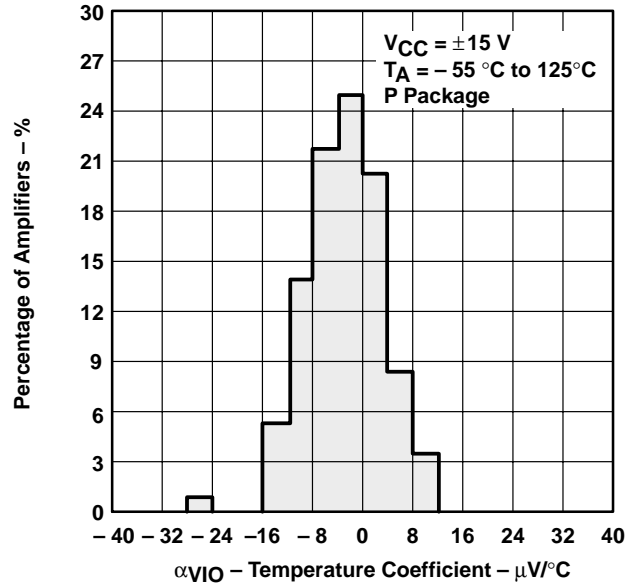

Figure 9

DISTRIBUTION OF TLE2082 INPUT OFFSET  
VOLTAGE TEMPERATURE COEFFICIENT

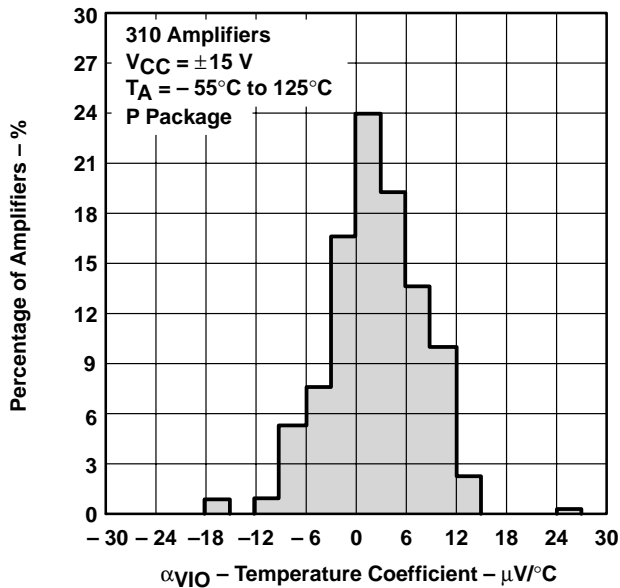

Figure 10

DISTRIBUTION OF TLE2084 INPUT OFFSET  
VOLTAGE TEMPERATURE COEFFICIENT

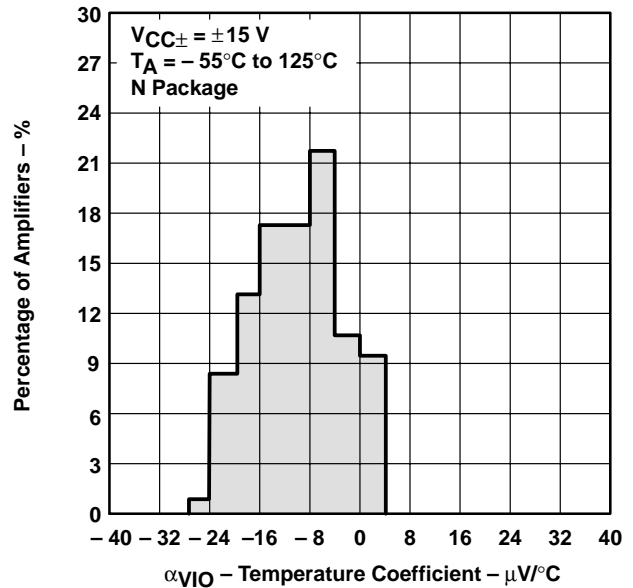

Figure 11

**TLE208x, TLE208xA, TLE208xY**  
**EXCALIBUR HIGH-SPEED JFET-INPUT**  
**OPERATIONAL AMPLIFIERS**

SLOS182B – FEBRUARY 1997 – REVISED JUNE 2001

**TYPICAL CHARACTERISTICS†**

**TLE2081 AND TLE2082**  
**INPUT BIAS CURRENT AND INPUT OFFSET CURRENT**  
**vs**  
**FREE-AIR TEMPERATURE**

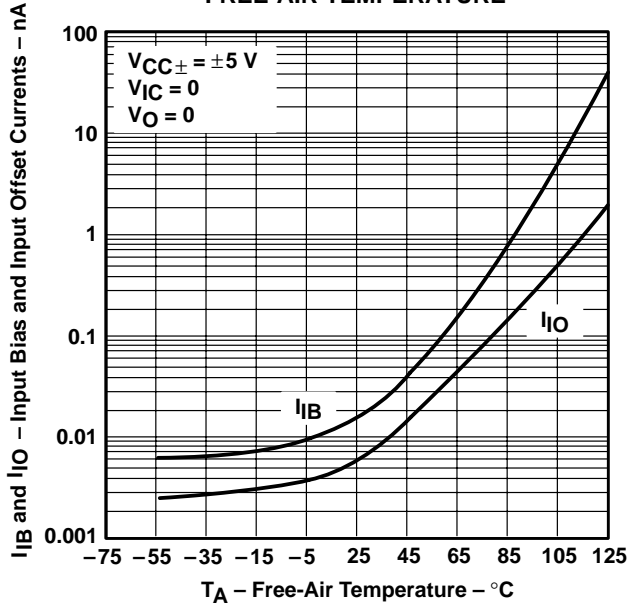

**Figure 12**

**TLE2084**  
**INPUT BIAS CURRENT AND INPUT OFFSET CURRENT**  
**vs**  
**FREE-AIR TEMPERATURE**

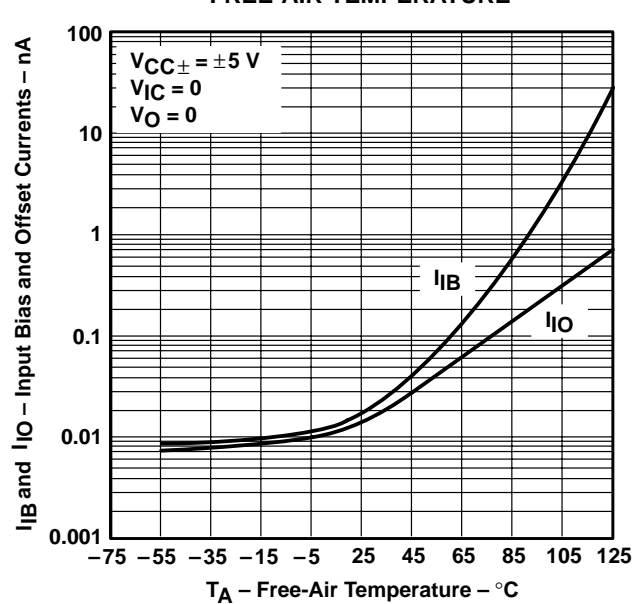

**Figure 13**

**TLE2081 AND TLE2082**  
**INPUT BIAS CURRENT AND INPUT OFFSET CURRENT**  
**vs**  
**FREE-AIR TEMPERATURE**

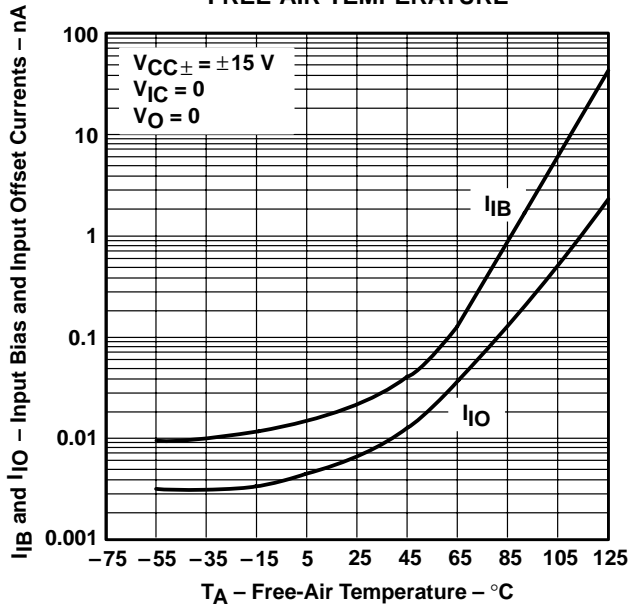

**Figure 14**

**TLE2084**  
**INPUT BIAS CURRENT AND INPUT OFFSET CURRENT**  
**vs**  
**FREE-AIR TEMPERATURE**

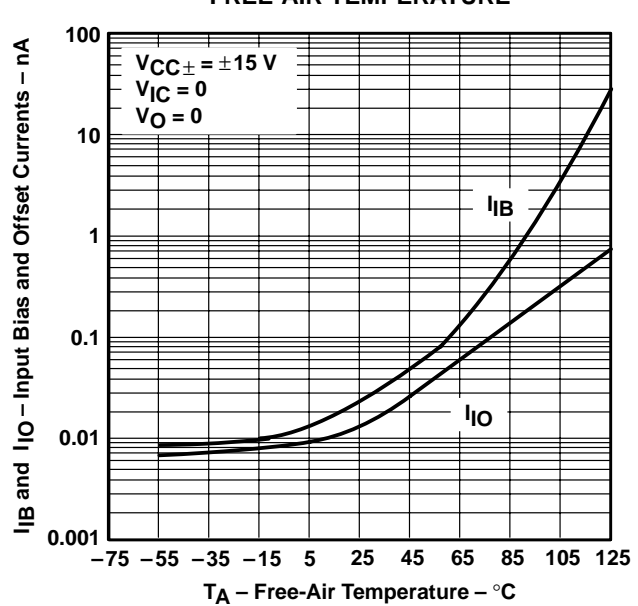
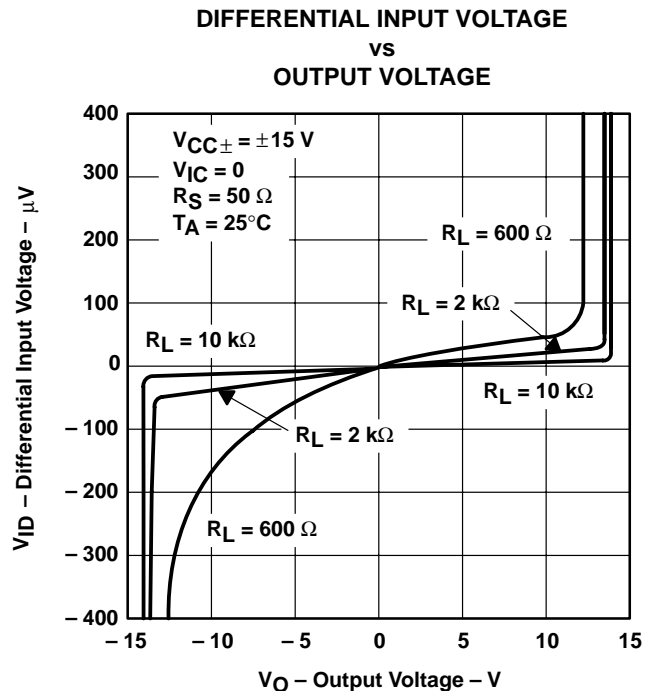
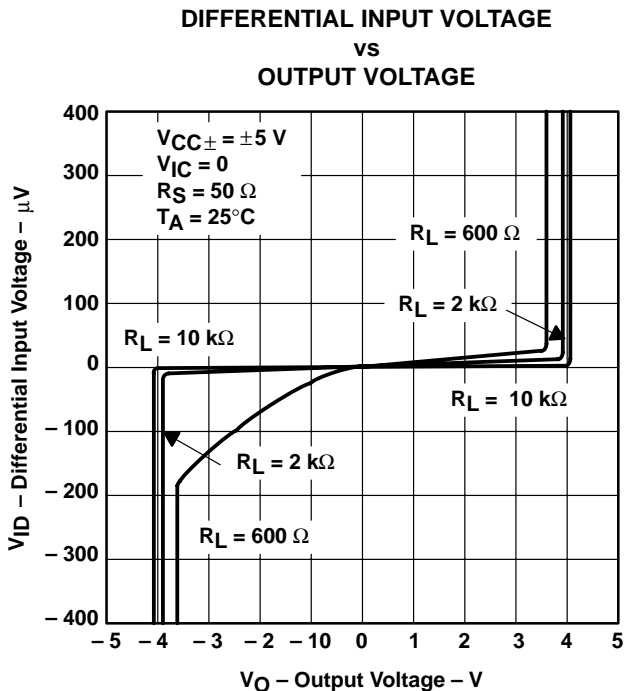
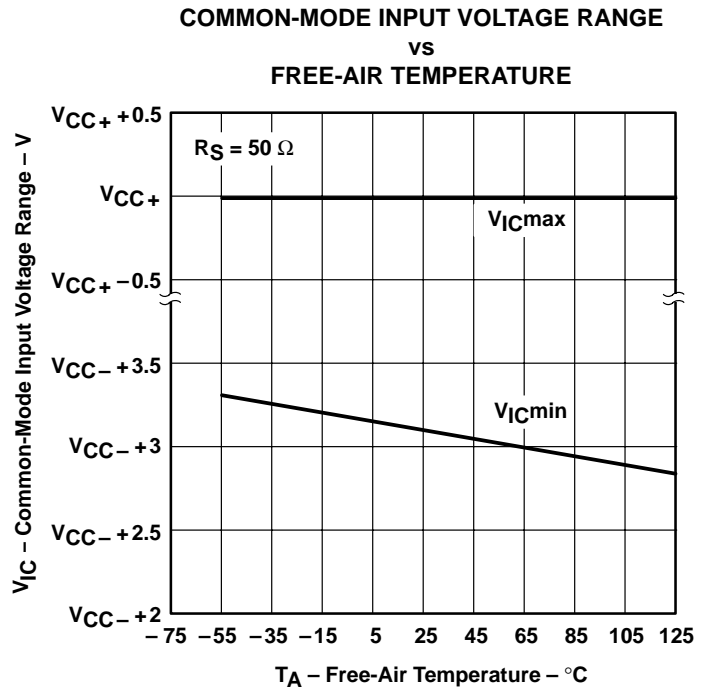
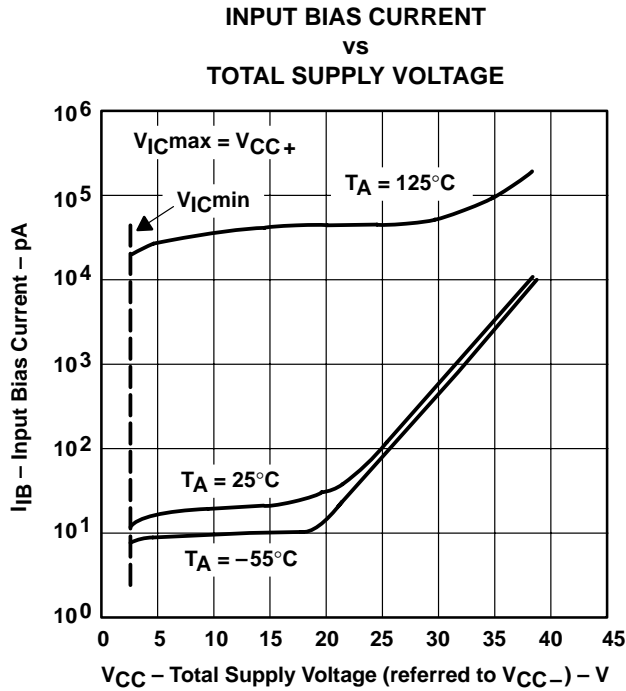

**Figure 15**

† Data at high and low temperatures are applicable only within the rated operating free-air temperature ranges of the various devices.



TYPICAL CHARACTERISTICS†



† Data at high and low temperatures are applicable only within the rated operating free-air temperature ranges of the various devices.

# TLE208x, TLE208xA, TLE208xY EXCALIBUR HIGH-SPEED JFET-INPUT OPERATIONAL AMPLIFIERS

SLOS182B – FEBRUARY 1997 – REVISED JUNE 2001

## TYPICAL CHARACTERISTICS†

**TLE2081 AND TLE2082  
MAXIMUM POSITIVE PEAK OUTPUT VOLTAGE  
vs  
OUTPUT CURRENT**

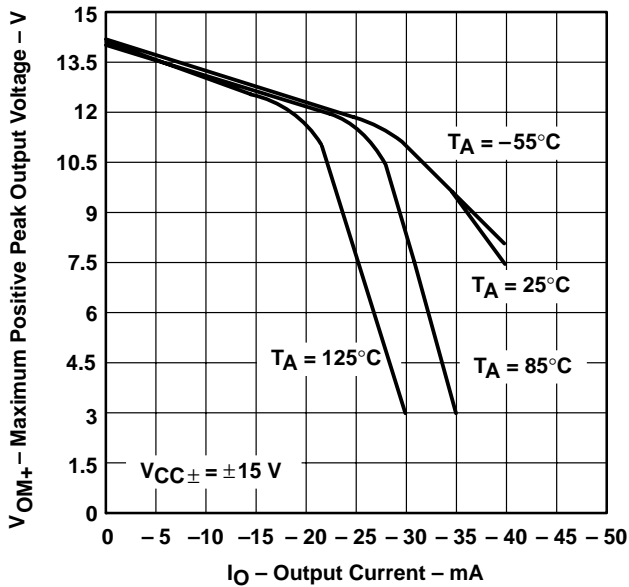

Figure 20

**TLE2084  
MAXIMUM POSITIVE PEAK OUTPUT VOLTAGE  
vs  
OUTPUT CURRENT**

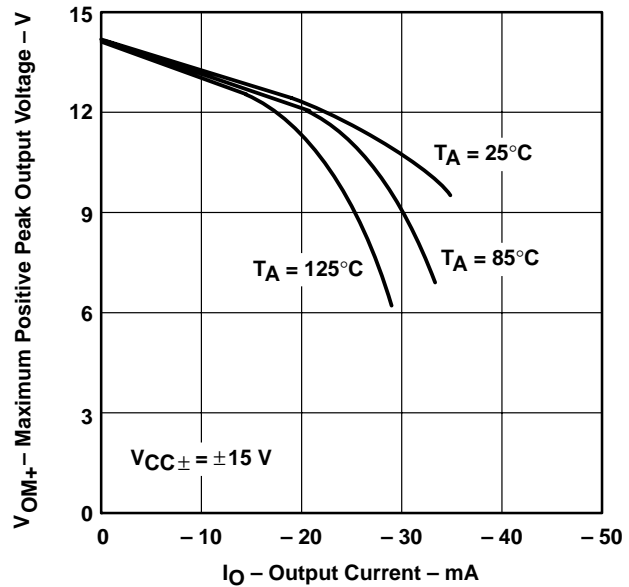

Figure 21

**TLE2081 AND TLE2082  
MAXIMUM NEGATIVE PEAK OUTPUT VOLTAGE  
vs  
OUTPUT CURRENT**

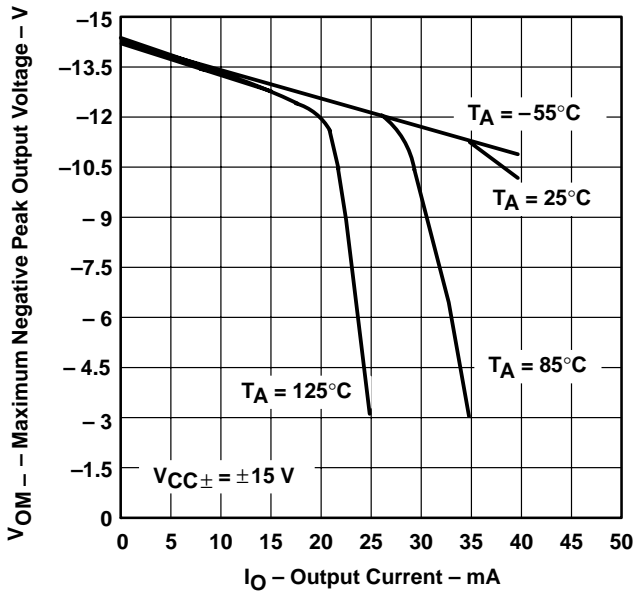

Figure 22

**TLE2084  
MAXIMUM NEGATIVE PEAK OUTPUT VOLTAGE  
vs  
OUTPUT CURRENT**

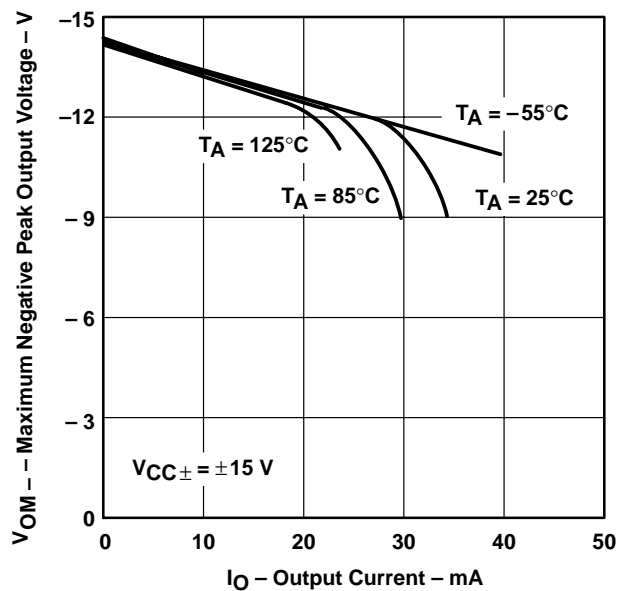

Figure 23

† Data at high and low temperatures are applicable only within the rated operating free-air temperature ranges of the various devices.

TYPICAL CHARACTERISTICS†

MAXIMUM PEAK OUTPUT VOLTAGE  
vs  
FREE-AIR TEMPERATURE

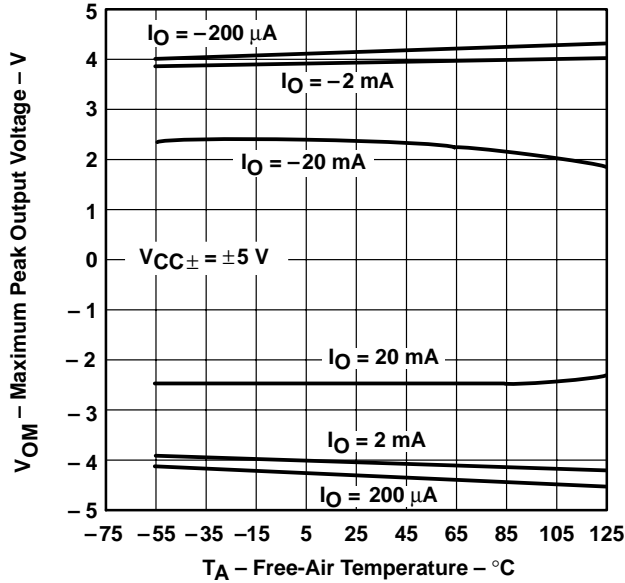

Figure 24

MAXIMUM PEAK OUTPUT VOLTAGE  
vs  
FREE-AIR TEMPERATURE

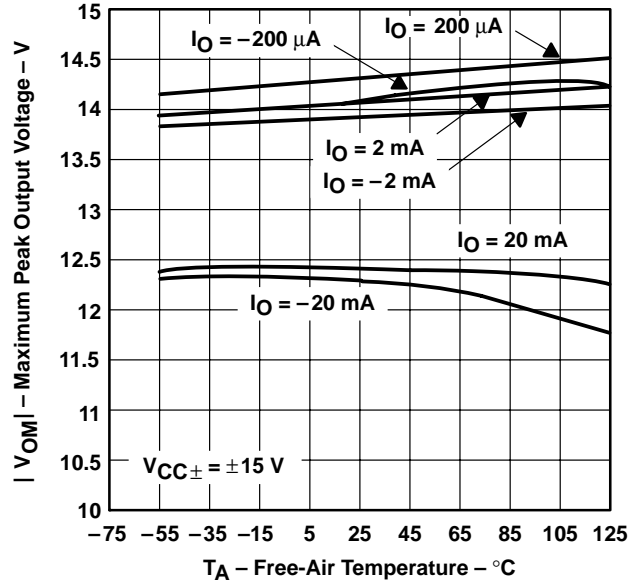

Figure 25

MAXIMUM PEAK OUTPUT VOLTAGE  
vs  
SUPPLY VOLTAGE

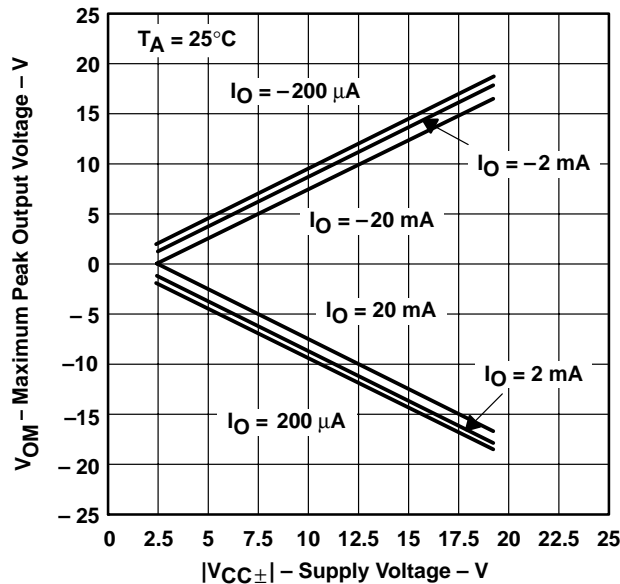

Figure 26

MAXIMUM PEAK-TO-PEAK OUTPUT VOLTAGE  
vs  
FREQUENCY

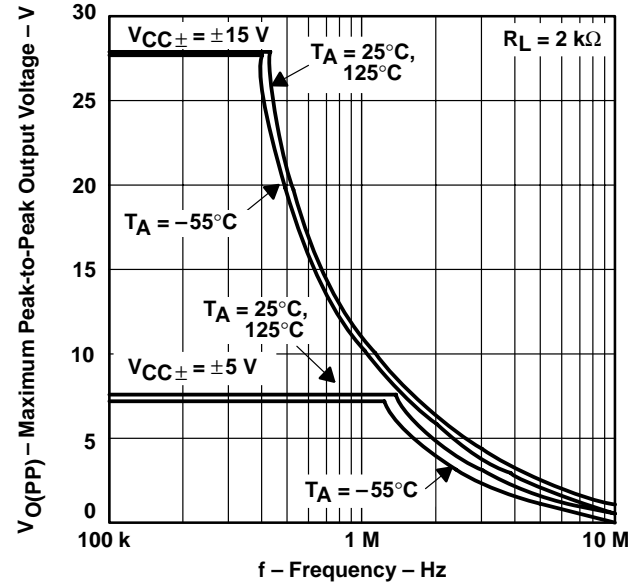

Figure 27

† Data at high and low temperatures are applicable only within the rated operating free-air temperature ranges of the various devices.

# TLE208x, TLE208xA, TLE208xY EXCALIBUR HIGH-SPEED JFET-INPUT OPERATIONAL AMPLIFIERS

SLOS182B – FEBRUARY 1997 – REVISED JUNE 2001

## TYPICAL CHARACTERISTICS†

OUTPUT VOLTAGE  
vs  
SETTLING TIME

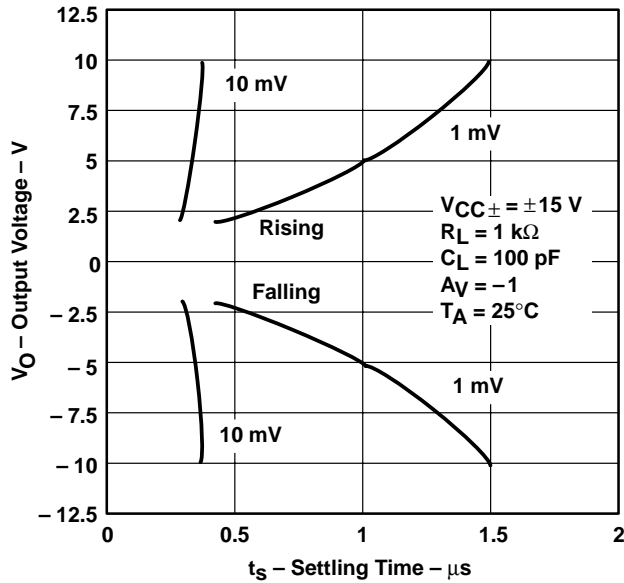

Figure 28

LARGE-SIGNAL DIFFERENTIAL  
VOLTAGE AMPLIFICATION  
vs  
LOAD RESISTANCE

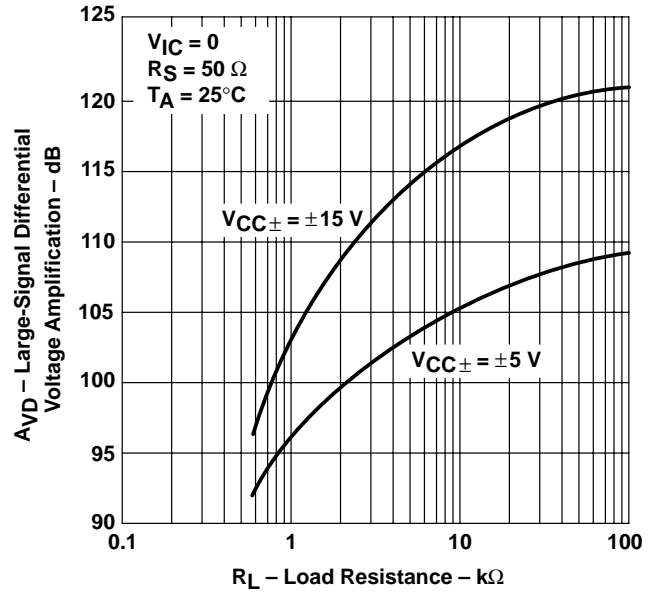

Figure 29

LARGE-SIGNAL DIFFERENTIAL  
VOLTAGE AMPLIFICATION  
vs  
FREE-AIR TEMPERATURE

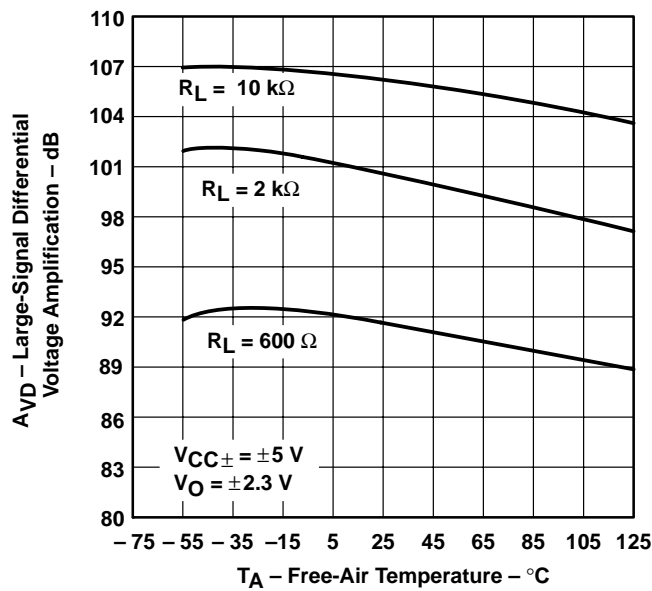

Figure 30

LARGE-SIGNAL DIFFERENTIAL  
VOLTAGE AMPLIFICATION  
vs  
FREE-AIR TEMPERATURE

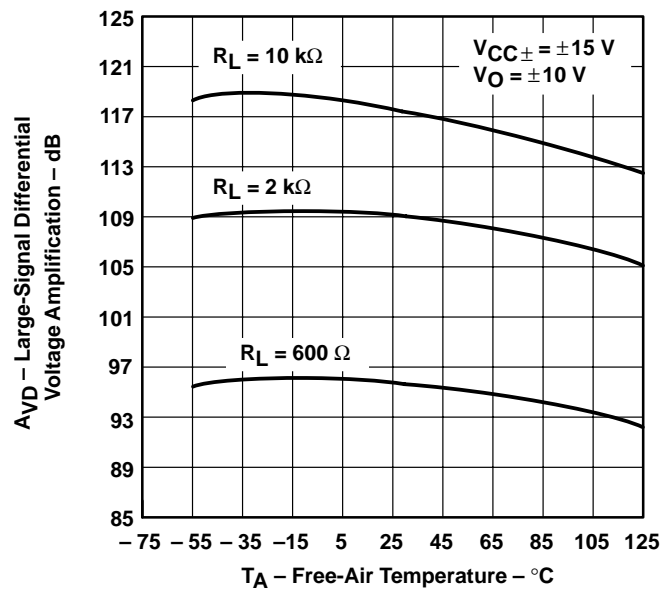

Figure 31

† Data at high and low temperatures are applicable only within the rated operating free-air temperature ranges of the various devices.

TYPICAL CHARACTERISTICS

SMALL-SIGNAL DIFFERENTIAL VOLTAGE  
 AMPLIFICATION AND PHASE SHIFT  
 vs  
 FREQUENCY

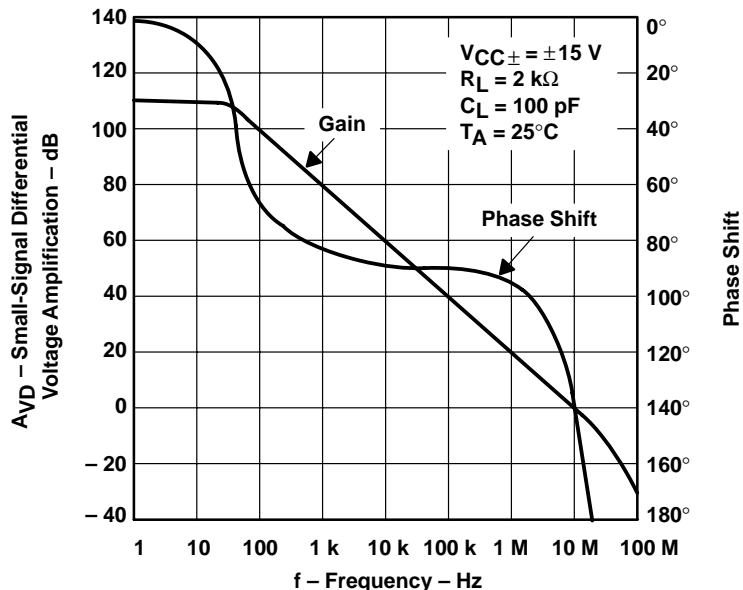

Figure 32

SMALL-SIGNAL DIFFERENTIAL VOLTAGE  
 AMPLIFICATION AND PHASE SHIFT  
 vs  
 FREQUENCY

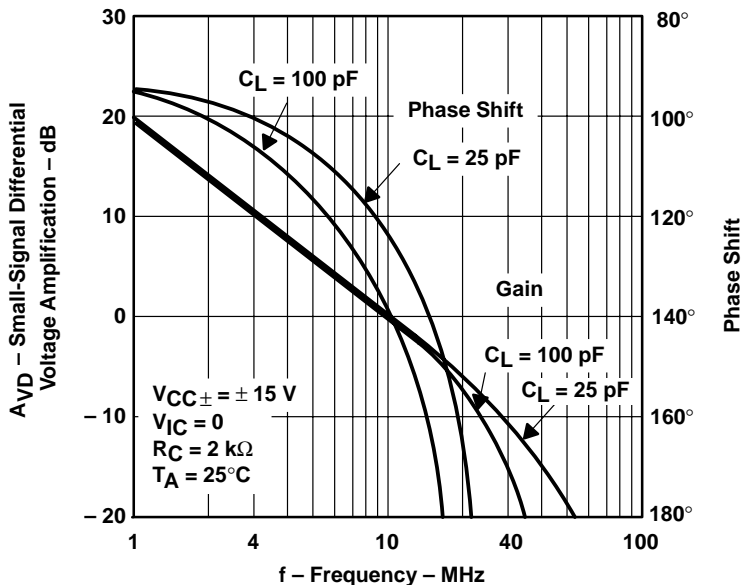

Figure 33

# TLE208x, TLE208xA, TLE208xY EXCALIBUR HIGH-SPEED JFET-INPUT OPERATIONAL AMPLIFIERS

SLOS182B – FEBRUARY 1997 – REVISED JUNE 2001

## TYPICAL CHARACTERISTICS†

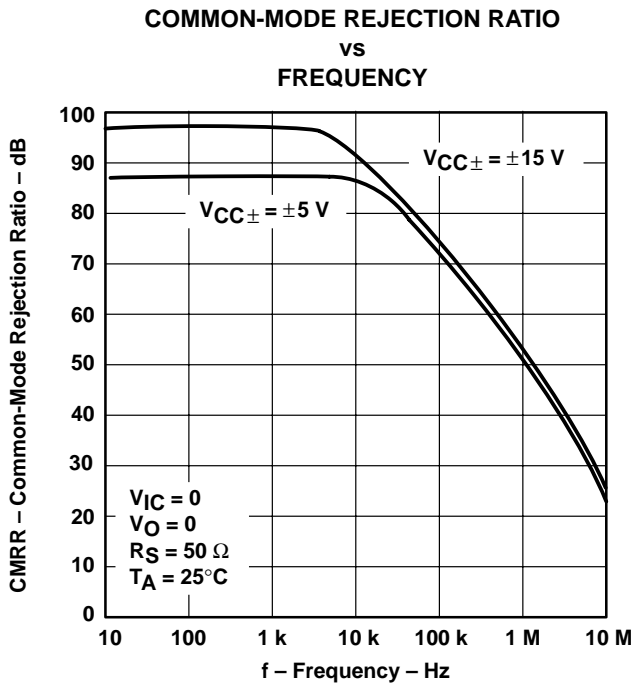

Figure 34

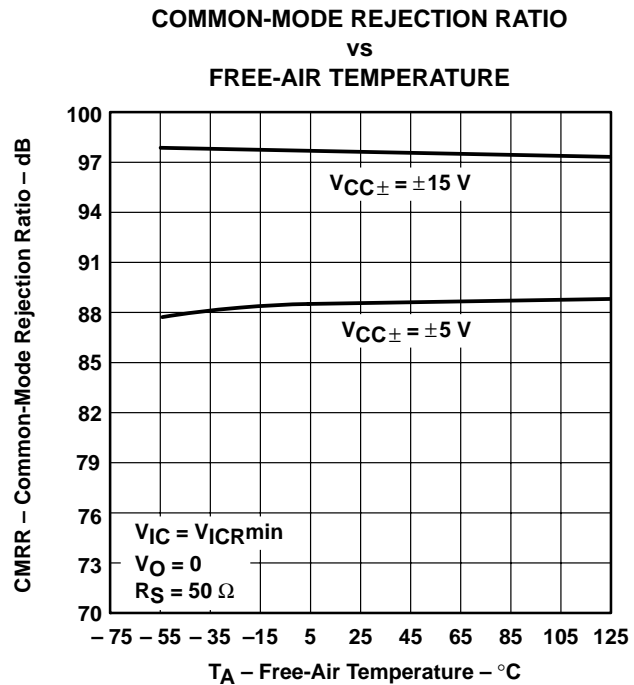

Figure 35

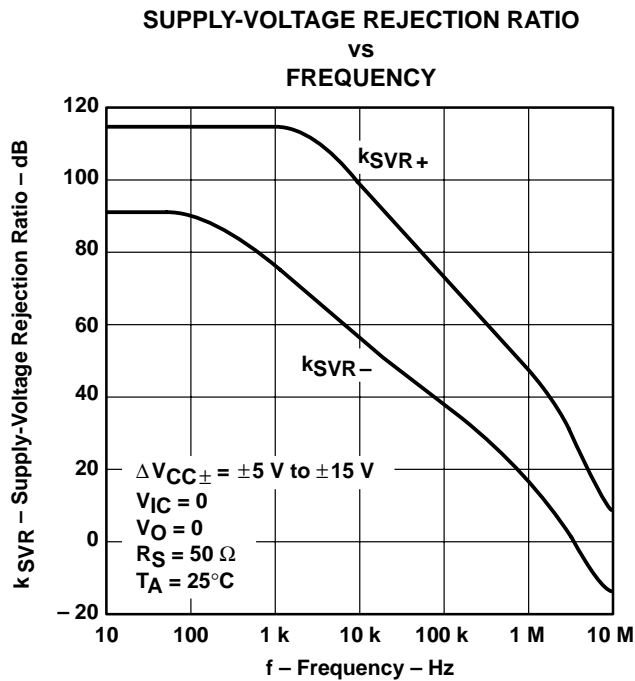

Figure 36

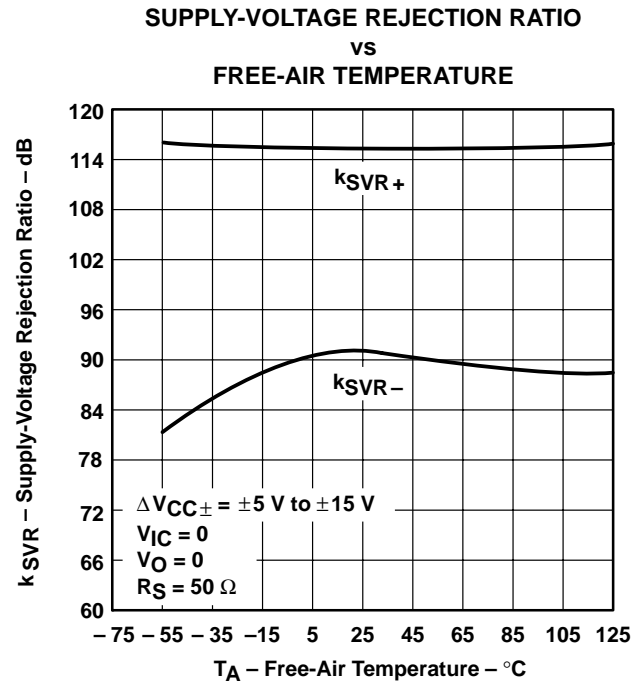
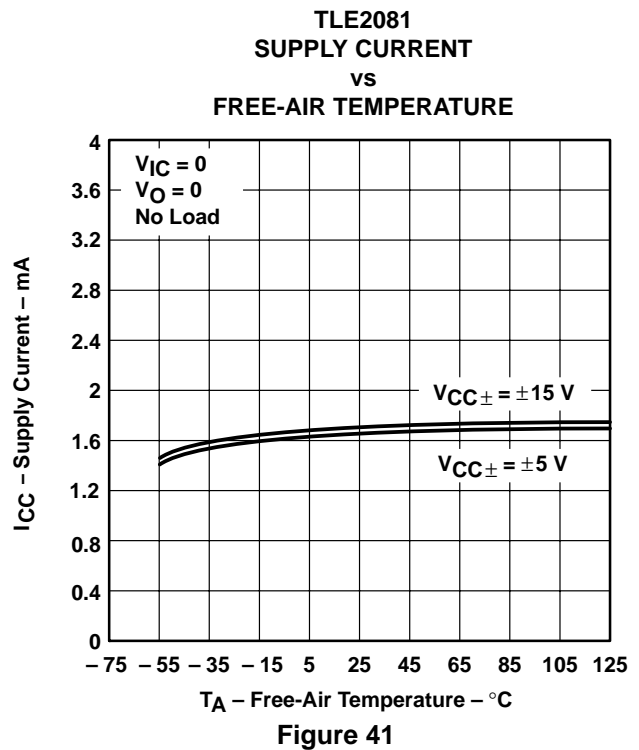
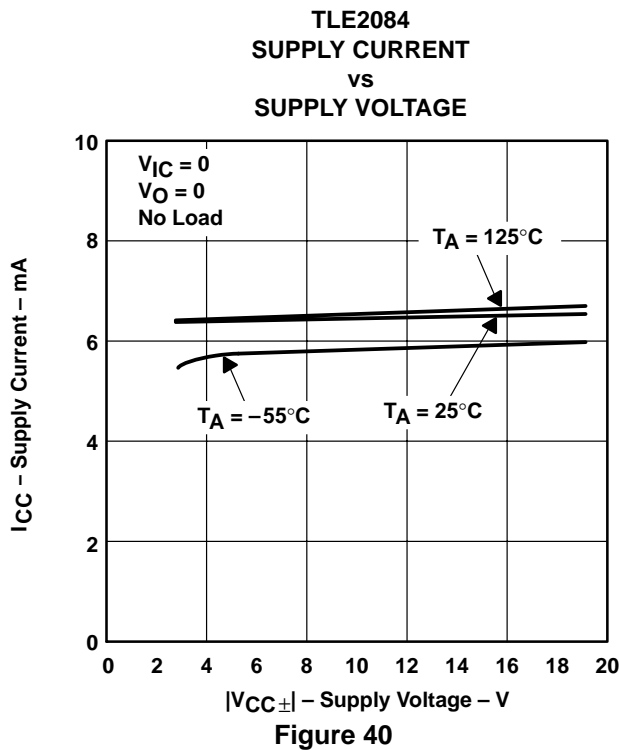
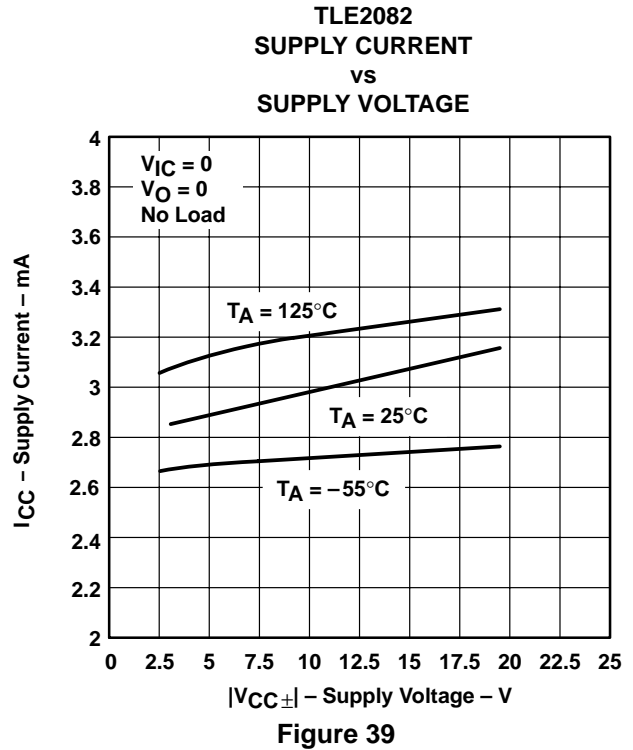
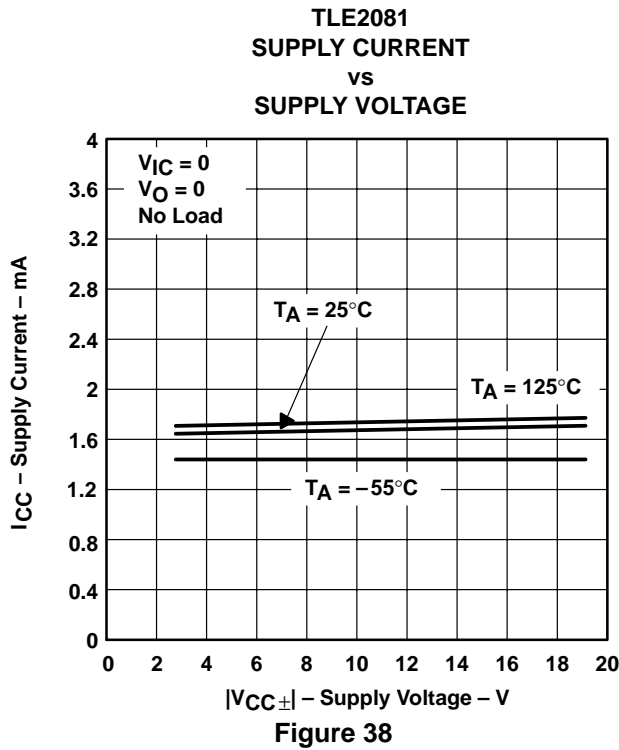

Figure 37

† Data at high and low temperatures are applicable only within the rated operating free-air temperature ranges of the various devices.

TYPICAL CHARACTERISTICS†



† Data at high and low temperatures are applicable only within the rated operating free-air temperature ranges of the various devices.

# TLE208x, TLE208xA, TLE208xY EXCALIBUR HIGH-SPEED JFET-INPUT OPERATIONAL AMPLIFIERS

SLOS182B – FEBRUARY 1997 – REVISED JUNE 2001

## TYPICAL CHARACTERISTICS†

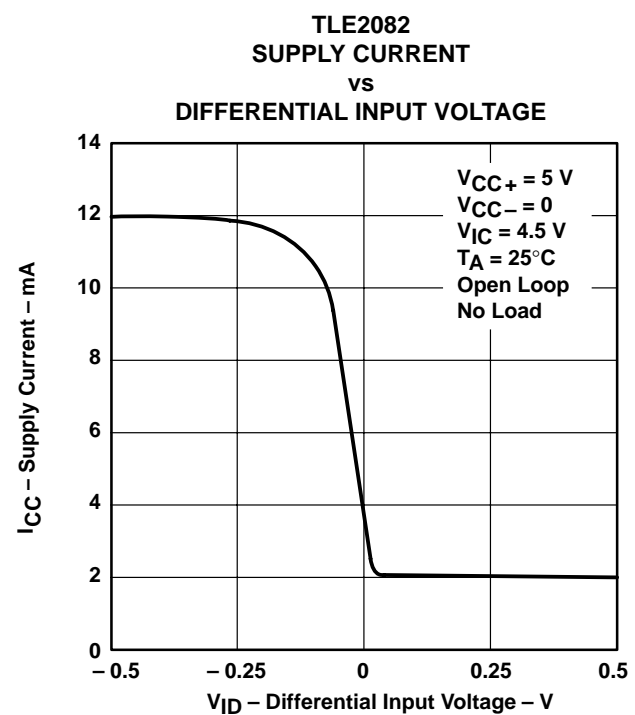
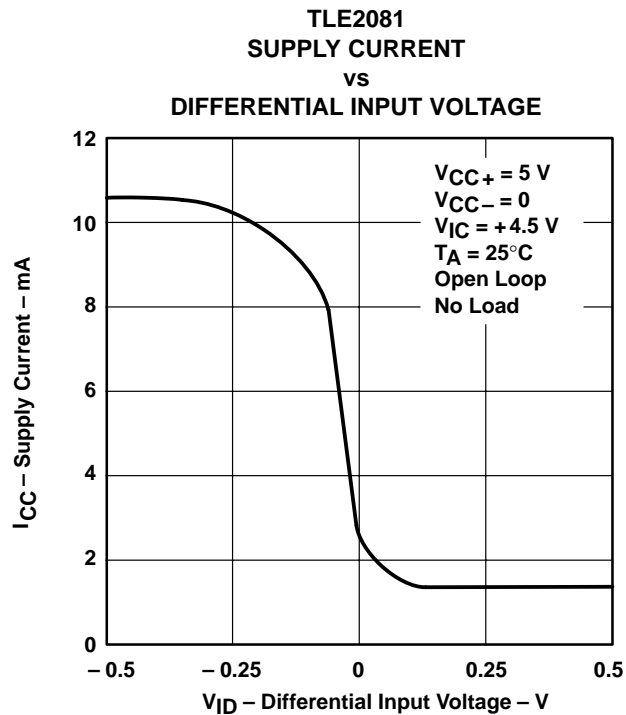
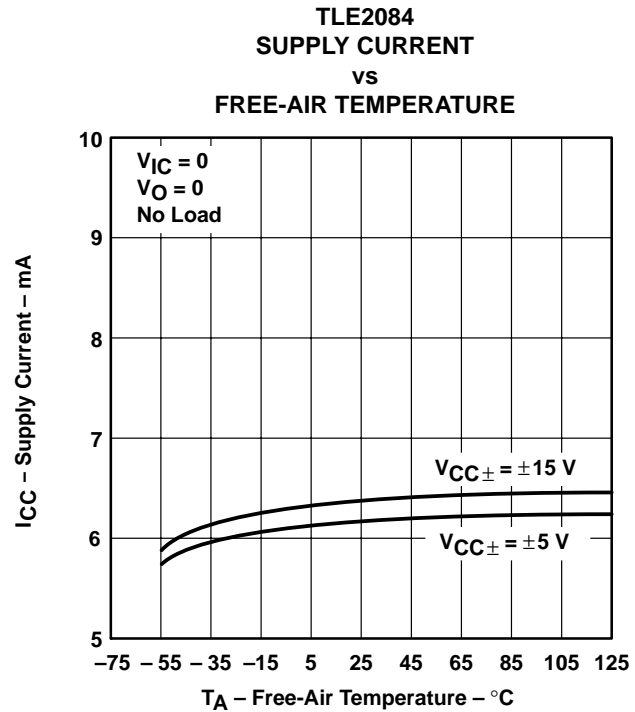
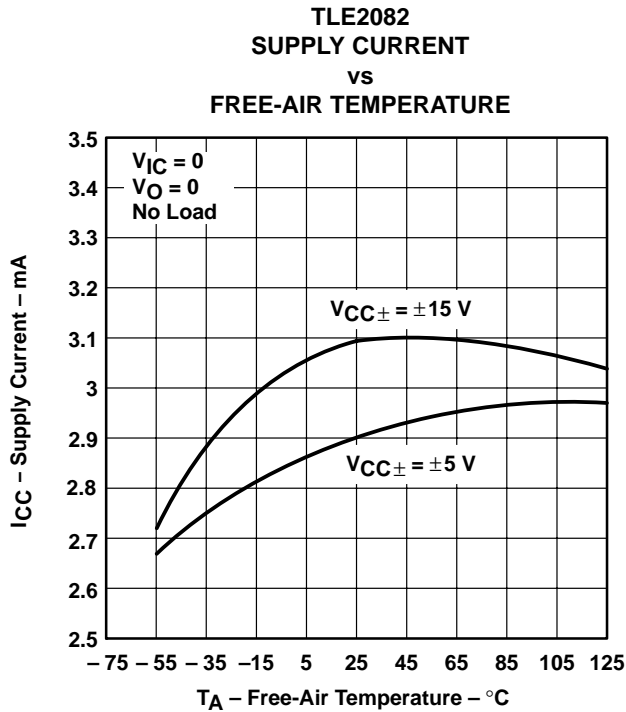

† Data at high and low temperatures are applicable only within the rated operating free-air temperature ranges of the various devices.

TYPICAL CHARACTERISTICS

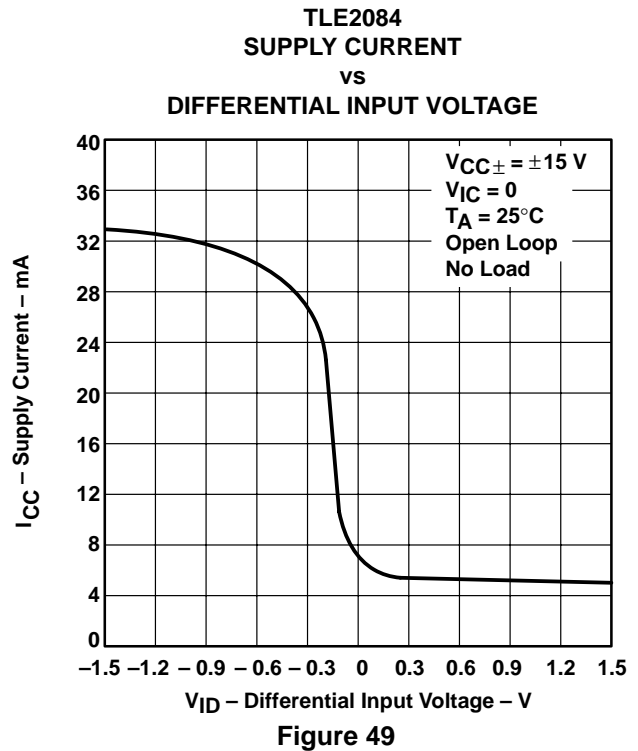
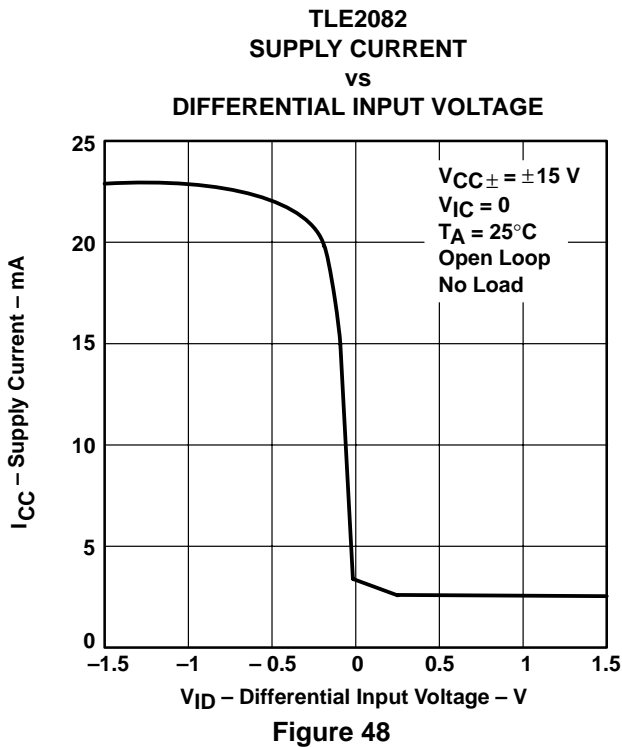
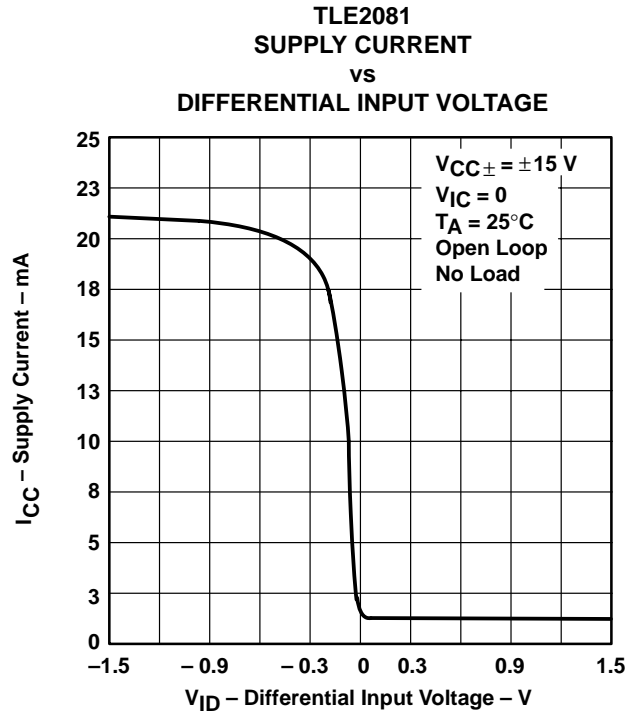
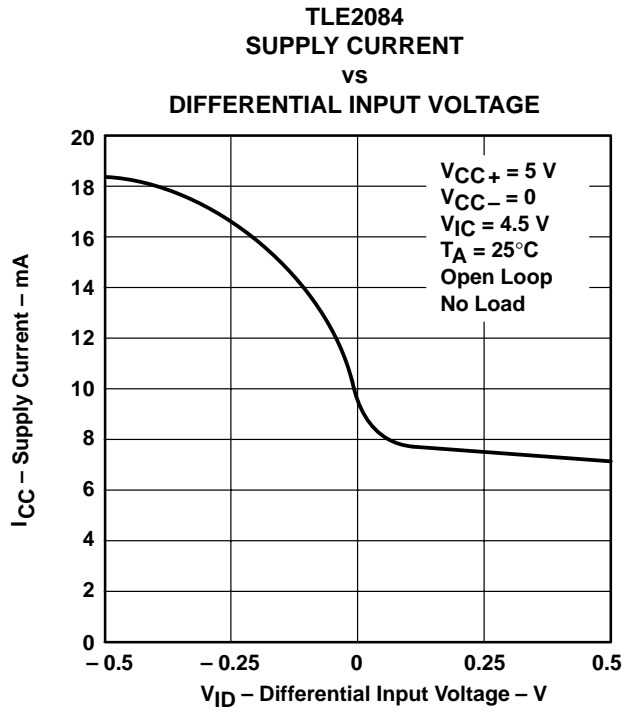

# TLE208x, TLE208xA, TLE208xY EXCALIBUR HIGH-SPEED JFET-INPUT OPERATIONAL AMPLIFIERS

SLOS182B – FEBRUARY 1997 – REVISED JUNE 2001

## TYPICAL CHARACTERISTICS†

SHORT-CIRCUIT OUTPUT CURRENT  
vs  
SUPPLY VOLTAGE

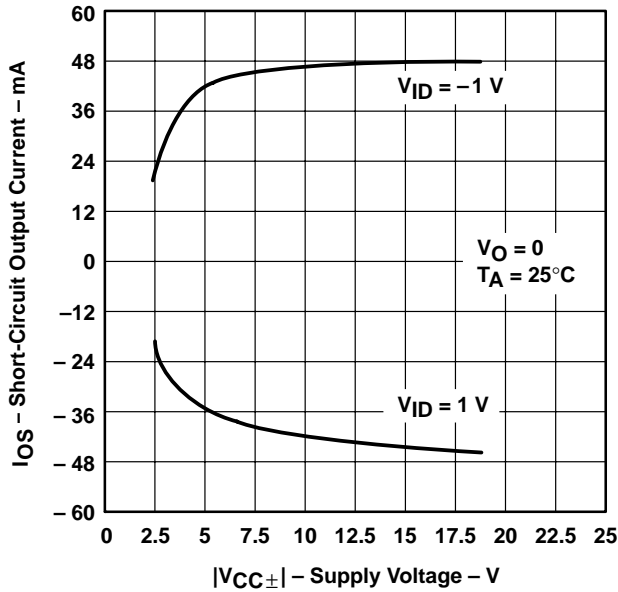

Figure 50

SHORT-CIRCUIT OUTPUT CURRENT  
vs  
ELAPSED TIME

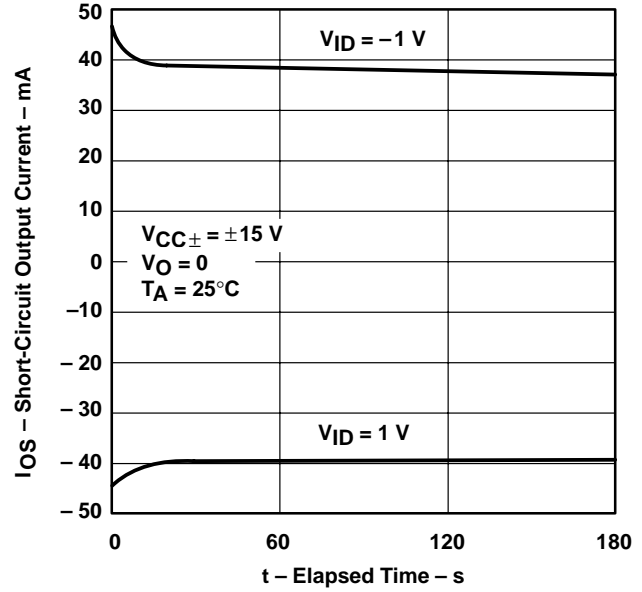

Figure 51

SHORT-CIRCUIT OUTPUT CURRENT  
vs  
FREE-AIR TEMPERATURE

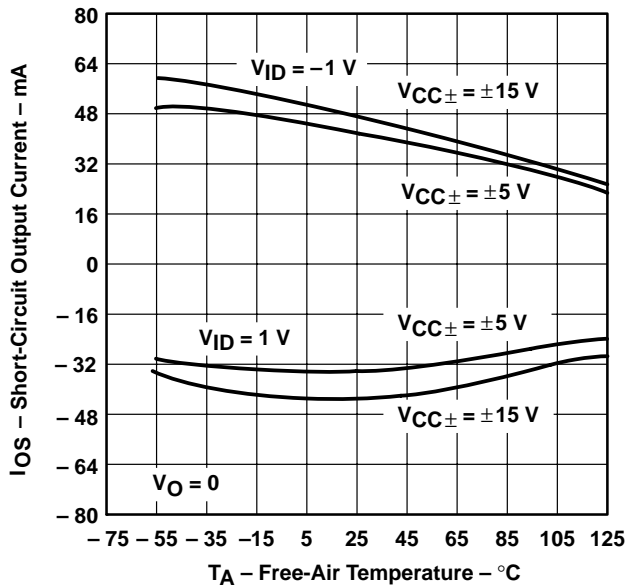

Figure 52

SLEW RATE  
vs  
FREE-AIR TEMPERATURE

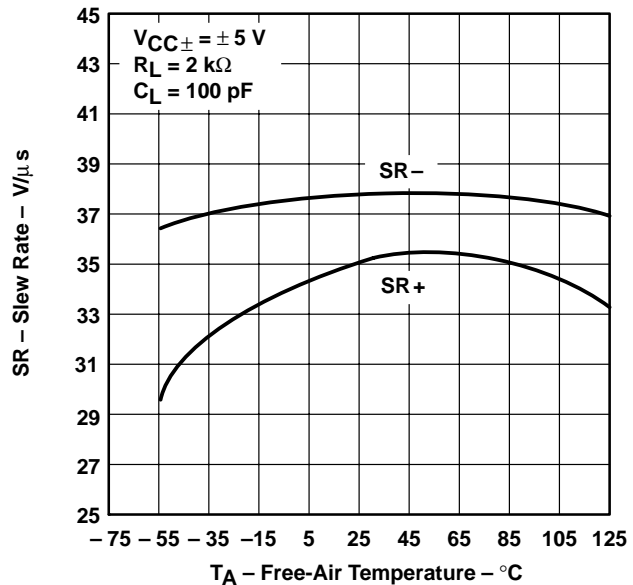

Figure 53

† Data at high and low temperatures are applicable only within the rated operating free-air temperature ranges of the various devices.



TYPICAL CHARACTERISTICS†

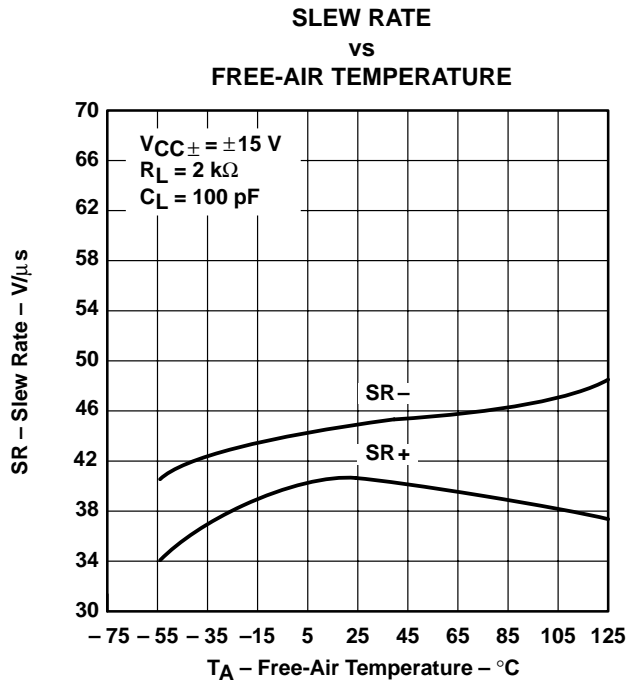

Figure 54

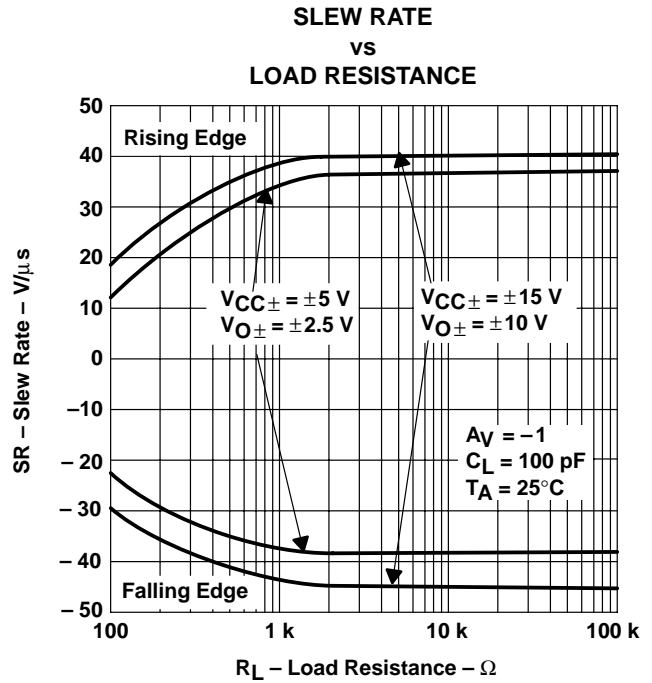

Figure 55

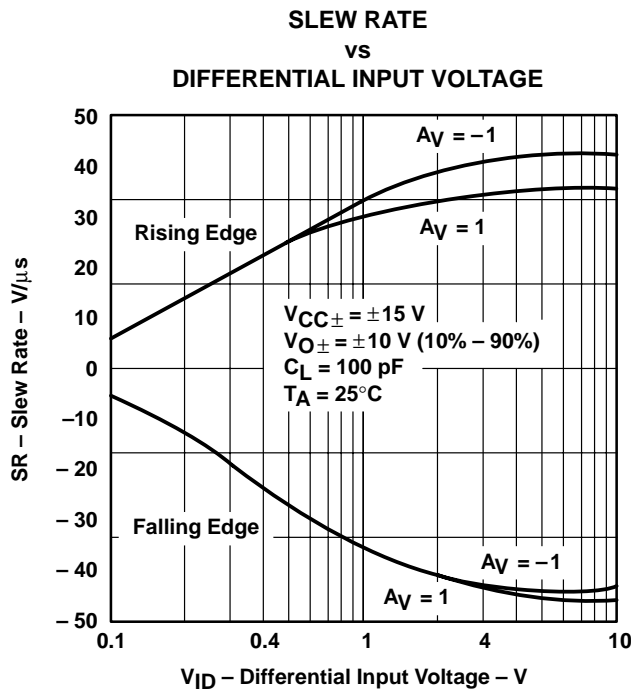

Figure 56

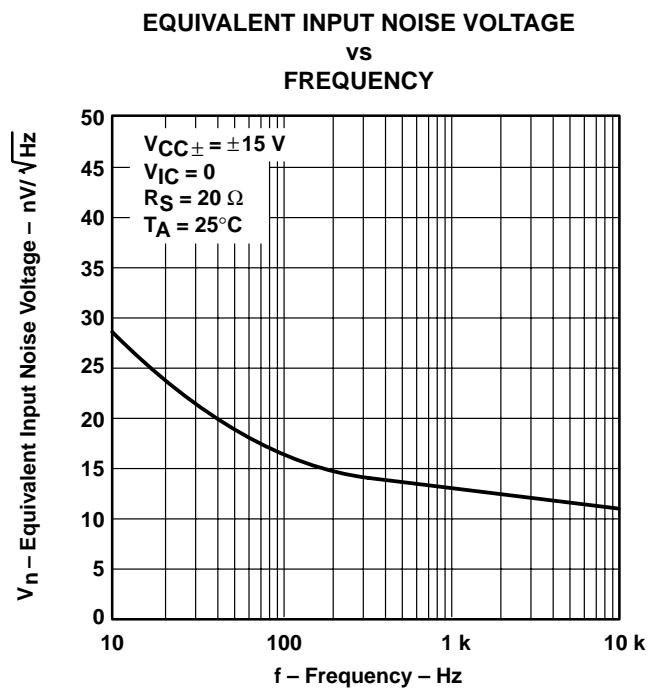

Figure 57

† Data at high and low temperatures are applicable only within the rated operating free-air temperature ranges of the various devices.

**TLE208x, TLE208xA, TLE208xY**  
**EXCALIBUR HIGH-SPEED JFET-INPUT**  
**OPERATIONAL AMPLIFIERS**

SLOS182B – FEBRUARY 1997 – REVISED JUNE 2001

**TYPICAL CHARACTERISTICS**

**INPUT-REFERRED NOISE VOLTAGE**  
**vs**  
**NOISE BANDWIDTH FREQUENCY**

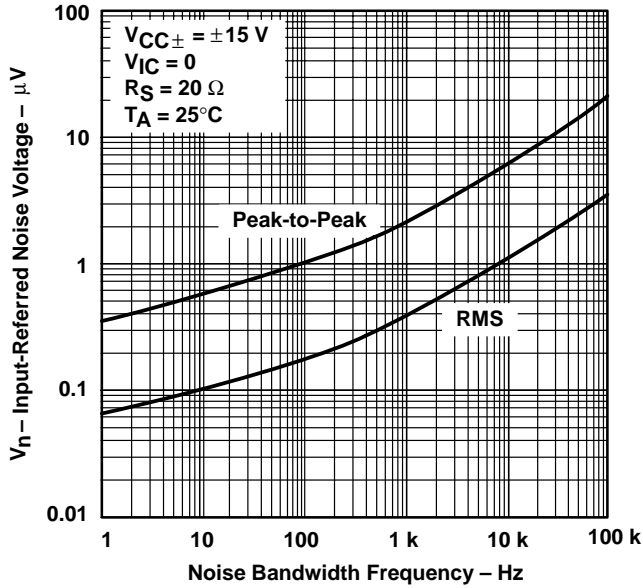

**Figure 58**

**INPUT-REFERRED NOISE VOLTAGE**  
**OVER A 10-SECOND TIME INTERVAL**

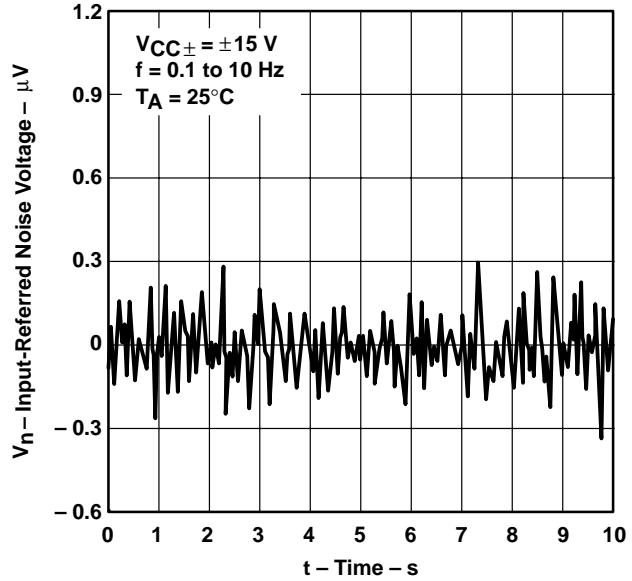

**Figure 59**

**THIRD-OCTAVE SPECTRAL NOISE DENSITY**  
**vs**  
**FREQUENCY BANDS**

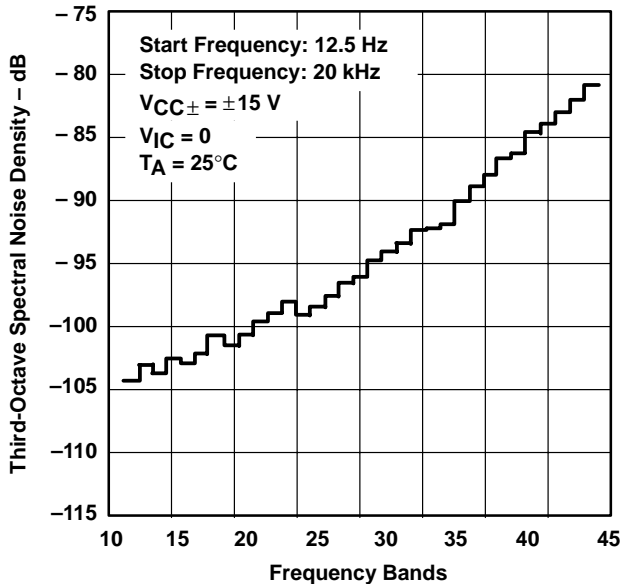

**Figure 60**

**TOTAL HARMONIC DISTORTION PLUS NOISE**  
**vs**  
**FREQUENCY**

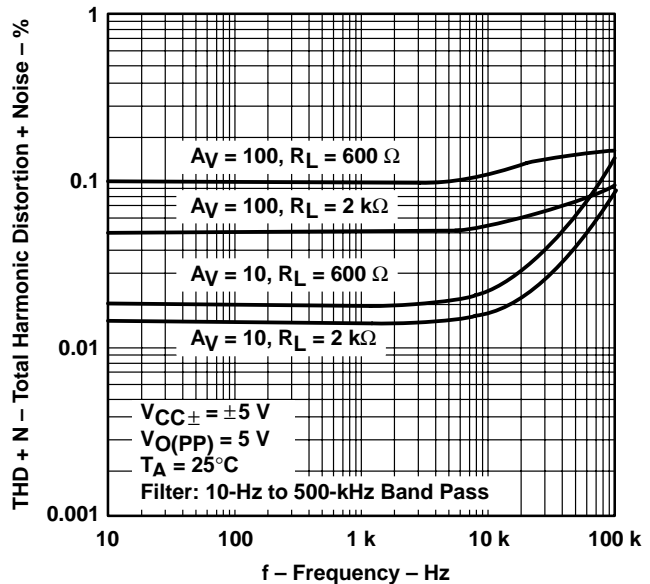

**Figure 61**

TYPICAL CHARACTERISTICS†

TOTAL HARMONIC DISTORTION PLUS NOISE  
vs  
FREQUENCY

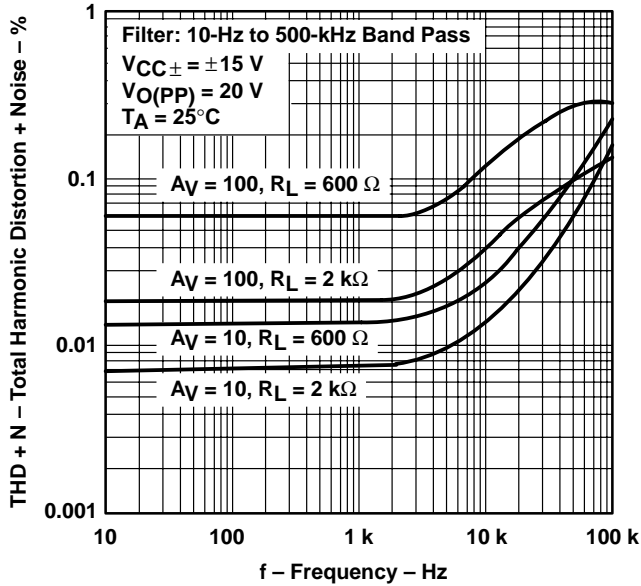

Figure 62

UNITY-GAIN BANDWIDTH  
vs  
LOAD CAPACITANCE

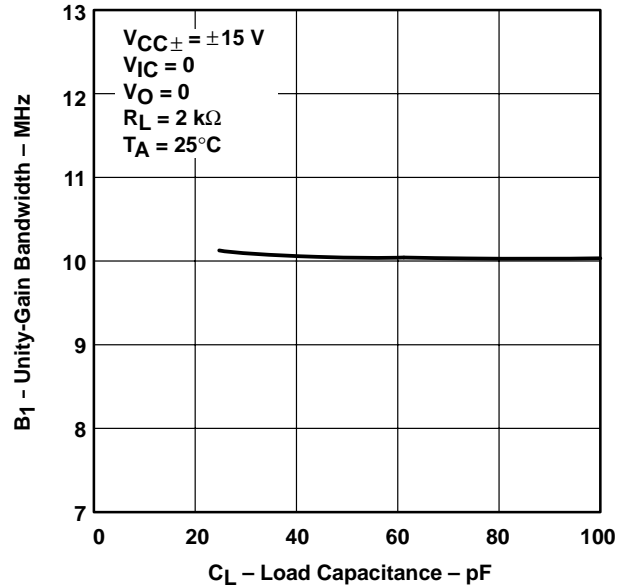

Figure 63

GAIN-BANDWIDTH PRODUCT  
vs  
FREE-AIR TEMPERATURE

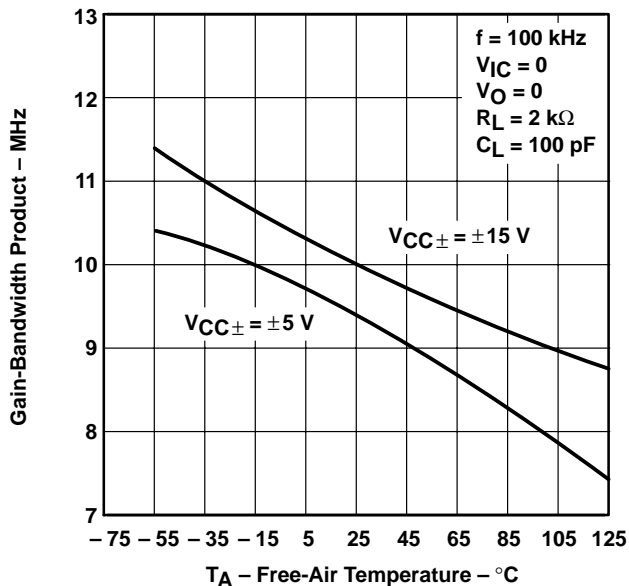

Figure 64

GAIN-BANDWIDTH PRODUCT  
vs  
SUPPLY VOLTAGE

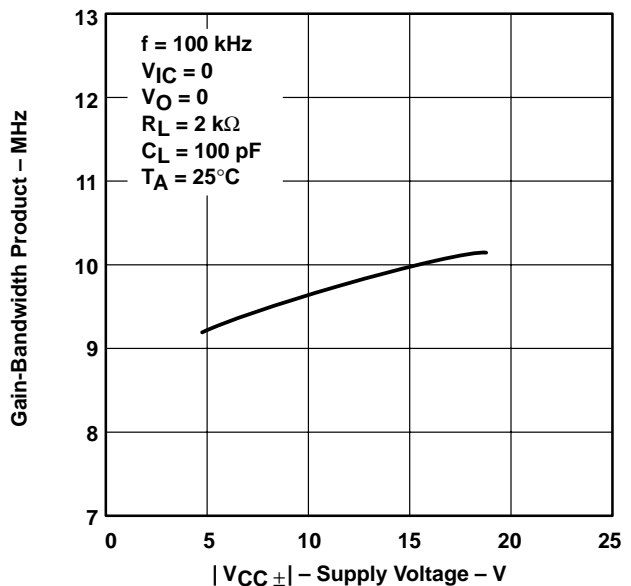

Figure 65

† Data at high and low temperatures are applicable only within the rated operating free-air temperature ranges of the various devices.

# TLE208x, TLE208xA, TLE208xY EXCALIBUR HIGH-SPEED JFET-INPUT OPERATIONAL AMPLIFIERS

SLOS182B – FEBRUARY 1997 – REVISED JUNE 2001

## TYPICAL CHARACTERISTICS†

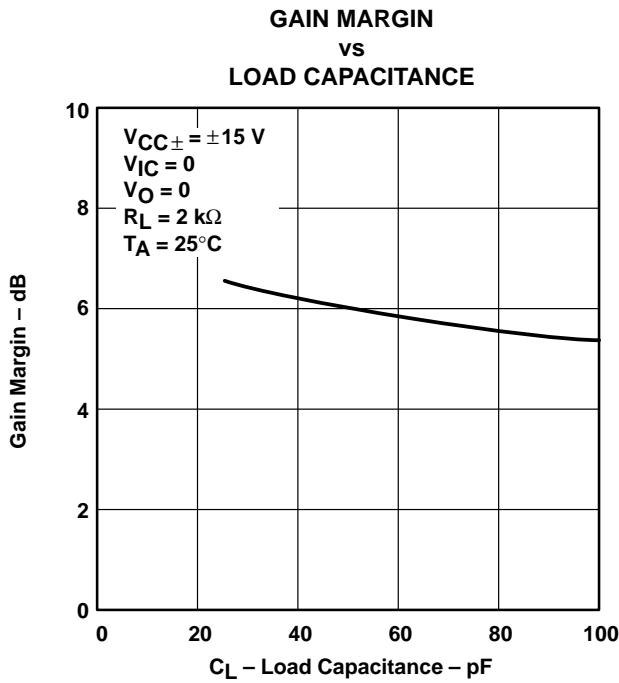

Figure 66

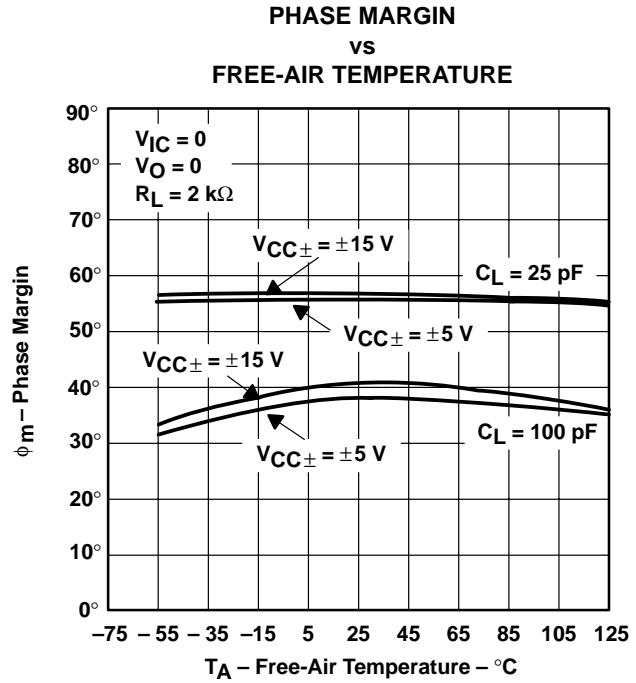

Figure 67

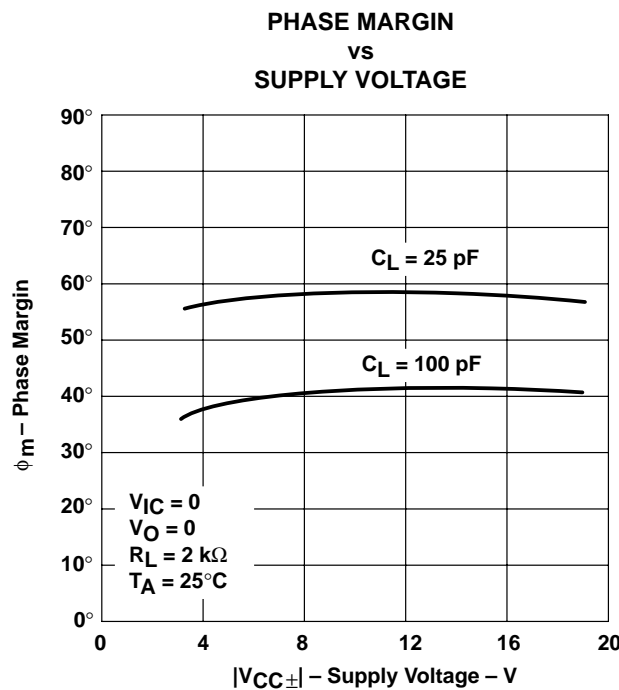

Figure 68

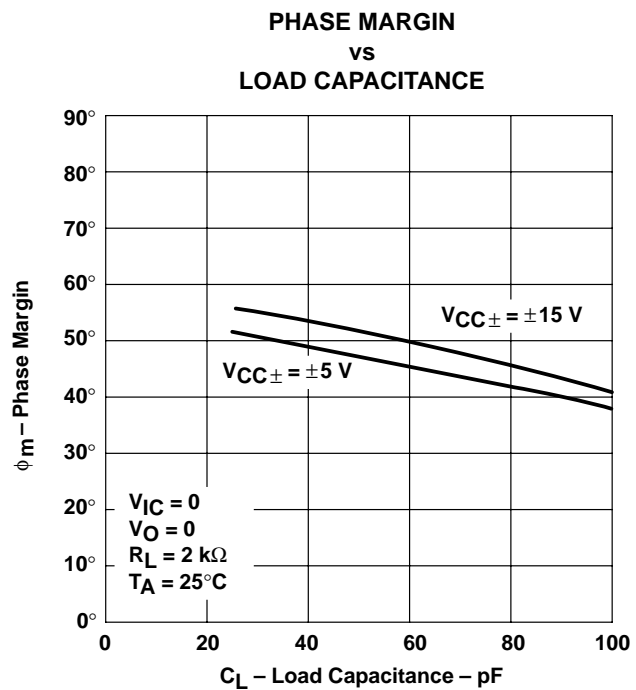

Figure 69

† Data at high and low temperatures are applicable only within the rated operating free-air temperature ranges of the various devices.

TYPICAL CHARACTERISTICS†

NONINVERTING LARGE-SIGNAL  
PULSE RESPONSE

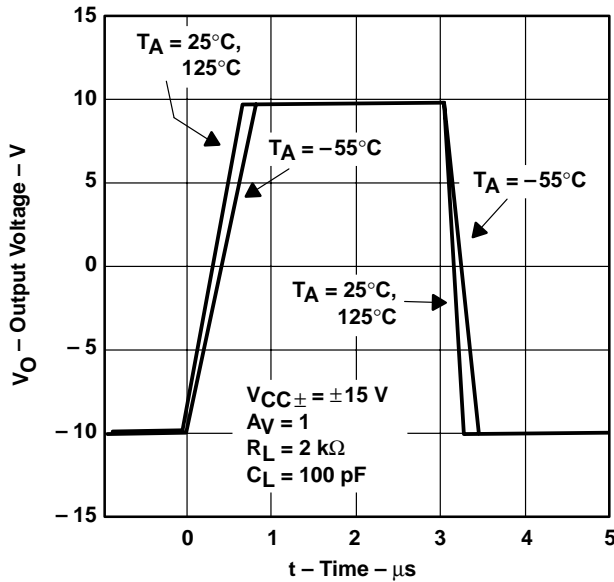

Figure 70

SMALL-SIGNAL PULSE RESPONSE

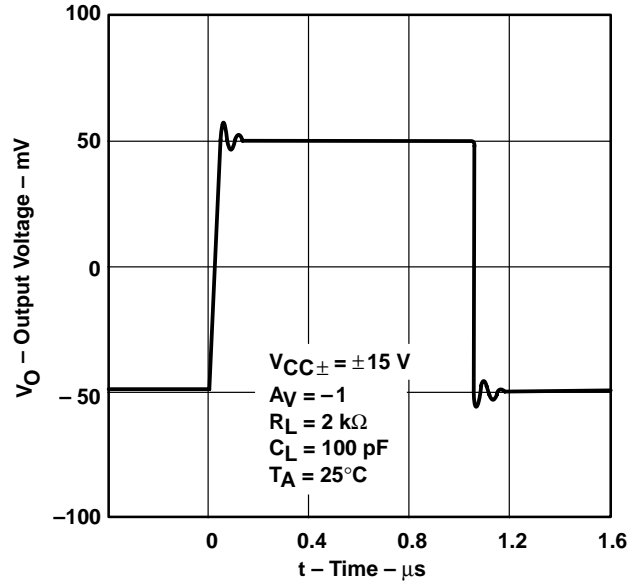

Figure 71

CLOSED-LOOP OUTPUT IMPEDANCE  
vs  
FREQUENCY

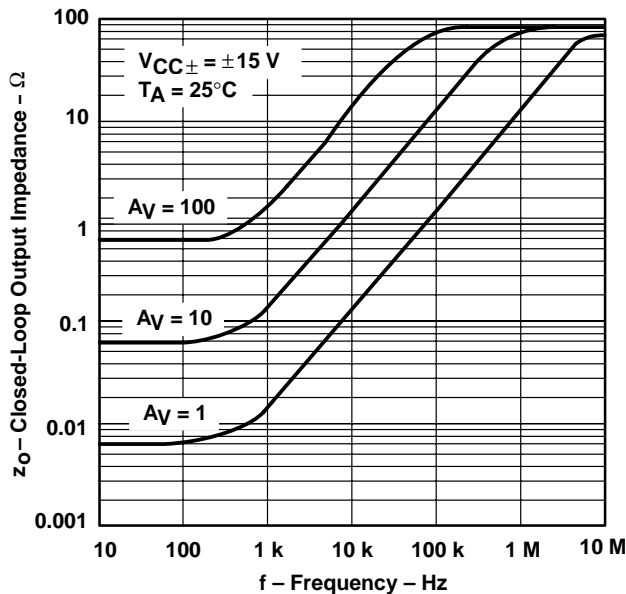

Figure 72

TLE2082 AND TLE2084  
CROSSTALK ATTENUATION  
vs  
FREQUENCY

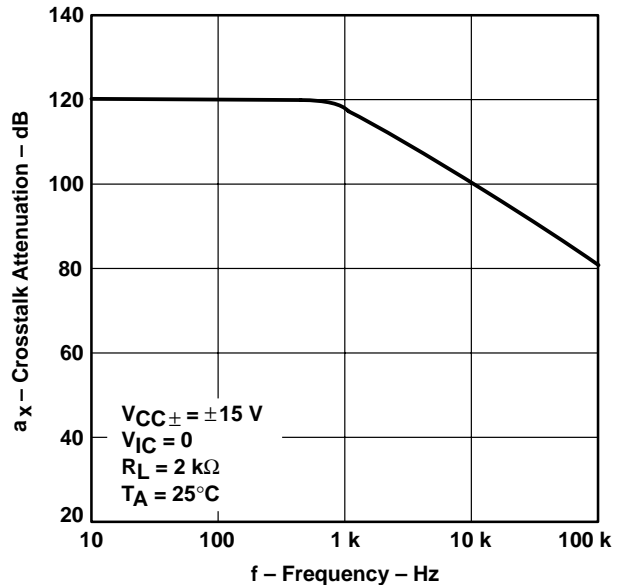

Figure 73

† Data at high and low temperatures are applicable only within the rated operating free-air temperature ranges of the various devices.

# TLE208x, TLE208xA, TLE208xY EXCALIBUR HIGH-SPEED JFET-INPUT OPERATIONAL AMPLIFIERS

SLOS182B – FEBRUARY 1997 – REVISED JUNE 2001

## APPLICATION INFORMATION

### input characteristics

The TLE208x, TLE208xA, and TLE208xB are specified with a minimum and a maximum input voltage that if exceeded at either input could cause the device to malfunction. Because of the extremely high input impedance and resulting low bias current requirements, the TLE208x, TLE208xA, and TLE208xB are well suited for low-level signal processing; however, leakage currents on printed-circuit boards and sockets can easily exceed bias current requirements and cause degradation in system performance. It is good practice to include guard rings around inputs (see Figure 74). These guards should be driven from a low-impedance source at the same voltage level as the common-mode input.

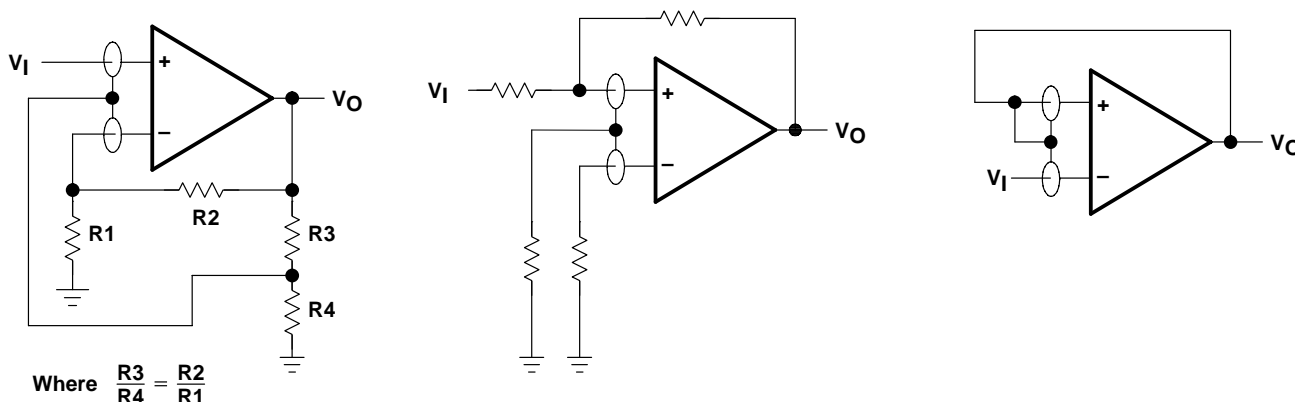

Figure 74. Use of Guard Rings

### TLE2081 input offset voltage nulling

The TLE2061 series offers external null pins that can be used to further reduce the input offset voltage. The circuit of Figure 75 can be connected as shown if the feature is desired. When external nulling is not needed, the null pins may be left unconnected.

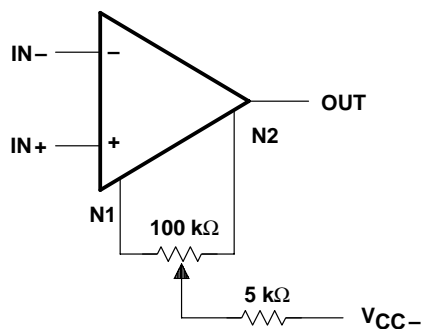

Figure 75. Input Offset Voltage Nulling

APPLICATION INFORMATION

macromodel information

Macromodel information provided was derived using *PSpice™ Parts™* model generation software. The Boyle macromodel (see Note 4) and subcircuit in Figure 58 were generated using the TLE208x typical electrical and operating characteristics at  $T_A = 25^\circ\text{C}$ . Using this information, output simulations of the following key parameters can be generated to a tolerance of 20% (in most cases):

- Maximum positive output voltage swing
- Maximum negative output voltage swing
- Slew rate
- Quiescent power dissipation
- Input bias current
- Open-loop voltage amplification
- Unity-gain frequency
- Common-mode rejection ratio
- Phase margin
- DC output resistance
- AC output resistance
- Short-circuit output current limit

NOTE 4: G.R. Boyle, B.M. Cohn, D. O. Pederson, and J. E. Solomon, "Macromodeling of Integrated Circuit Operational Amplifiers", *IEEE Journal of Solid-State Circuits*, SC-9, 353 (1974).

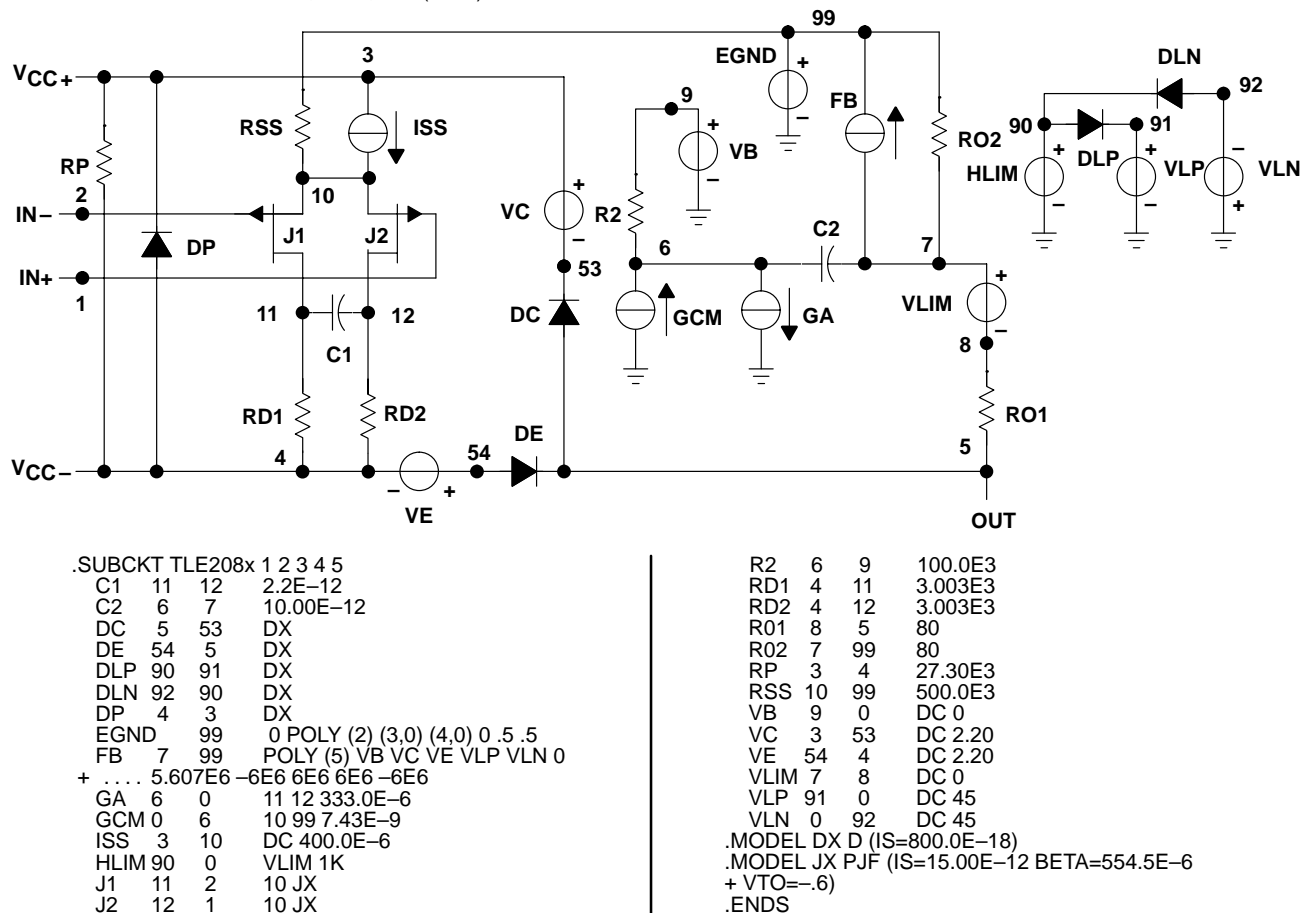

Figure 76. Boyle Macromodel and Subcircuit

*PSpice* and *Parts* are trademarks of MicroSim Corporation.

**PACKAGING INFORMATION**

| Orderable Device | Status<br>(1) | Package Type | Package Drawing | Pins | Package Qty | Eco Plan<br>(2) | Lead finish/<br>Ball material<br>(6) | MSL Peak Temp<br>(3) | Op Temp (°C) | Device Marking<br>(4/5) | Samples                 |
|------------------|---------------|--------------|-----------------|------|-------------|-----------------|--------------------------------------|----------------------|--------------|-------------------------|-------------------------|
| TLE2081ACDR      | ACTIVE        | SOIC         | D               | 8    | 2500        | RoHS & Green    | NIPDAU                               | Level-1-260C-UNLIM   | 0 to 70      | 2081AC                  | <a href="#">Samples</a> |
| TLE2081ACP       | ACTIVE        | PDIP         | P               | 8    | 50          | RoHS & Green    | NIPDAU                               | N / A for Pkg Type   | -40 to 85    | TLE2081AC               | <a href="#">Samples</a> |
| TLE2081AID       | ACTIVE        | SOIC         | D               | 8    | 75          | RoHS & Green    | NIPDAU                               | Level-1-260C-UNLIM   | -40 to 85    | 2081AI                  | <a href="#">Samples</a> |
| TLE2081AIP       | ACTIVE        | PDIP         | P               | 8    | 50          | RoHS & Green    | NIPDAU                               | N / A for Pkg Type   | -40 to 85    | TLE2081AI               | <a href="#">Samples</a> |
| TLE2081CDR       | ACTIVE        | SOIC         | D               | 8    | 2500        | RoHS & Green    | NIPDAU                               | Level-1-260C-UNLIM   | 0 to 70      | 2081C                   | <a href="#">Samples</a> |
| TLE2081CP        | ACTIVE        | PDIP         | P               | 8    | 50          | RoHS & Green    | NIPDAU                               | N / A for Pkg Type   | 0 to 70      | TLE2081CP               | <a href="#">Samples</a> |
| TLE2081IDR       | ACTIVE        | SOIC         | D               | 8    | 2500        | RoHS & Green    | NIPDAU                               | Level-1-260C-UNLIM   |              | 2081I                   | <a href="#">Samples</a> |
| TLE2081IP        | ACTIVE        | PDIP         | P               | 8    | 50          | RoHS & Green    | NIPDAU                               | N / A for Pkg Type   |              | TLE2081IP               | <a href="#">Samples</a> |
| TLE2082ACDR      | ACTIVE        | SOIC         | D               | 8    | 2500        | RoHS & Green    | NIPDAU                               | Level-1-260C-UNLIM   |              | 2082AC                  | <a href="#">Samples</a> |
| TLE2082ACDRG4    | LIFEBUY       | SOIC         | D               | 8    | 2500        | RoHS & Green    | NIPDAU                               | Level-1-260C-UNLIM   |              | 2082AC                  |                         |
| TLE2082ACP       | ACTIVE        | PDIP         | P               | 8    | 50          | RoHS & Green    | NIPDAU                               | N / A for Pkg Type   |              | TLE2082AC               | <a href="#">Samples</a> |
| TLE2082AIDR      | ACTIVE        | SOIC         | D               | 8    | 2500        | RoHS & Green    | NIPDAU                               | Level-1-260C-UNLIM   |              | 2082AI                  | <a href="#">Samples</a> |
| TLE2082AIP       | ACTIVE        | PDIP         | P               | 8    | 50          | RoHS & Green    | NIPDAU                               | N / A for Pkg Type   |              | TLE2082AI               | <a href="#">Samples</a> |
| TLE2082CDR       | ACTIVE        | SOIC         | D               | 8    | 2500        | RoHS & Green    | NIPDAU                               | Level-1-260C-UNLIM   |              | 2082C                   | <a href="#">Samples</a> |
| TLE2082CP        | ACTIVE        | PDIP         | P               | 8    | 50          | RoHS & Green    | NIPDAU                               | N / A for Pkg Type   |              | TLE2082CP               | <a href="#">Samples</a> |
| TLE2082CPE4      | ACTIVE        | PDIP         | P               | 8    | 50          | TBD             | Call TI                              | Call TI              |              |                         | <a href="#">Samples</a> |
| TLE2082IDR       | ACTIVE        | SOIC         | D               | 8    | 2500        | RoHS & Green    | NIPDAU                               | Level-1-260C-UNLIM   |              | 2082I                   | <a href="#">Samples</a> |
| TLE2082IP        | ACTIVE        | PDIP         | P               | 8    | 50          | RoHS & Green    | NIPDAU                               | N / A for Pkg Type   |              | TLE2082IP               | <a href="#">Samples</a> |
| TLE2084ACDW      | ACTIVE        | SOIC         | DW              | 16   | 40          | RoHS & Green    | NIPDAU                               | Level-1-260C-UNLIM   | 0 to 70      | TLE2084AC               | <a href="#">Samples</a> |
| TLE2084ACN       | ACTIVE        | PDIP         | N               | 14   | 25          | RoHS & Green    | NIPDAU                               | N / A for Pkg Type   | 0 to 70      | TLE2084ACN              | <a href="#">Samples</a> |

| Orderable Device | Status<br>(1) | Package Type | Package Drawing | Pins | Package Qty | Eco Plan<br>(2) | Lead finish/<br>Ball material<br>(6) | MSL Peak Temp<br>(3) | Op Temp (°C) | Device Marking<br>(4/5) | Samples                 |
|------------------|---------------|--------------|-----------------|------|-------------|-----------------|--------------------------------------|----------------------|--------------|-------------------------|-------------------------|
| TLE2084CDW       | ACTIVE        | SOIC         | DW              | 16   | 40          | RoHS & Green    | NIPDAU                               | Level-1-260C-UNLIM   | 0 to 70      | TLE2084C                | <a href="#">Samples</a> |
| TLE2084CDWR      | ACTIVE        | SOIC         | DW              | 16   | 2000        | RoHS & Green    | NIPDAU                               | Level-1-260C-UNLIM   |              | TLE2084C                | <a href="#">Samples</a> |
| TLE2084CN        | ACTIVE        | PDIP         | N               | 14   | 25          | RoHS & Green    | NIPDAU                               | N / A for Pkg Type   |              | TLE2084CN               | <a href="#">Samples</a> |
| TLE2084IDW       | ACTIVE        | SOIC         | DW              | 16   | 40          | RoHS & Green    | NIPDAU                               | Level-1-260C-UNLIM   | -40 to 85    | TLE2084I                | <a href="#">Samples</a> |

(1) The marketing status values are defined as follows:

**ACTIVE:** Product device recommended for new designs.

**LIFEBUY:** TI has announced that the device will be discontinued, and a lifetime-buy period is in effect.

**NRND:** Not recommended for new designs. Device is in production to support existing customers, but TI does not recommend using this part in a new design.

**PREVIEW:** Device has been announced but is not in production. Samples may or may not be available.

**OBSELETE:** TI has discontinued the production of the device.

(2) **RoHS:** TI defines "RoHS" to mean semiconductor products that are compliant with the current EU RoHS requirements for all 10 RoHS substances, including the requirement that RoHS substance do not exceed 0.1% by weight in homogeneous materials. Where designed to be soldered at high temperatures, "RoHS" products are suitable for use in specified lead-free processes. TI may reference these types of products as "Pb-Free".

**RoHS Exempt:** TI defines "RoHS Exempt" to mean products that contain lead but are compliant with EU RoHS pursuant to a specific EU RoHS exemption.

**Green:** TI defines "Green" to mean the content of Chlorine (Cl) and Bromine (Br) based flame retardants meet JS709B low halogen requirements of <=1000ppm threshold. Antimony trioxide based flame retardants must also meet the <=1000ppm threshold requirement.

(3) MSL, Peak Temp. - The Moisture Sensitivity Level rating according to the JEDEC industry standard classifications, and peak solder temperature.

(4) There may be additional marking, which relates to the logo, the lot trace code information, or the environmental category on the device.

(5) Multiple Device Markings will be inside parentheses. Only one Device Marking contained in parentheses and separated by a "~" will appear on a device. If a line is indented then it is a continuation of the previous line and the two combined represent the entire Device Marking for that device.

(6) Lead finish/Ball material - Orderable Devices may have multiple material finish options. Finish options are separated by a vertical ruled line. Lead finish/Ball material values may wrap to two lines if the finish value exceeds the maximum column width.

**Important Information and Disclaimer:**The information provided on this page represents TI's knowledge and belief as of the date that it is provided. TI bases its knowledge and belief on information provided by third parties, and makes no representation or warranty as to the accuracy of such information. Efforts are underway to better integrate information from third parties. TI has taken and continues to take reasonable steps to provide representative and accurate information but may not have conducted destructive testing or chemical analysis on incoming materials and chemicals. TI and TI suppliers consider certain information to be proprietary, and thus CAS numbers and other limited information may not be available for release.

In no event shall TI's liability arising out of such information exceed the total purchase price of the TI part(s) at issue in this document sold by TI to Customer on an annual basis.

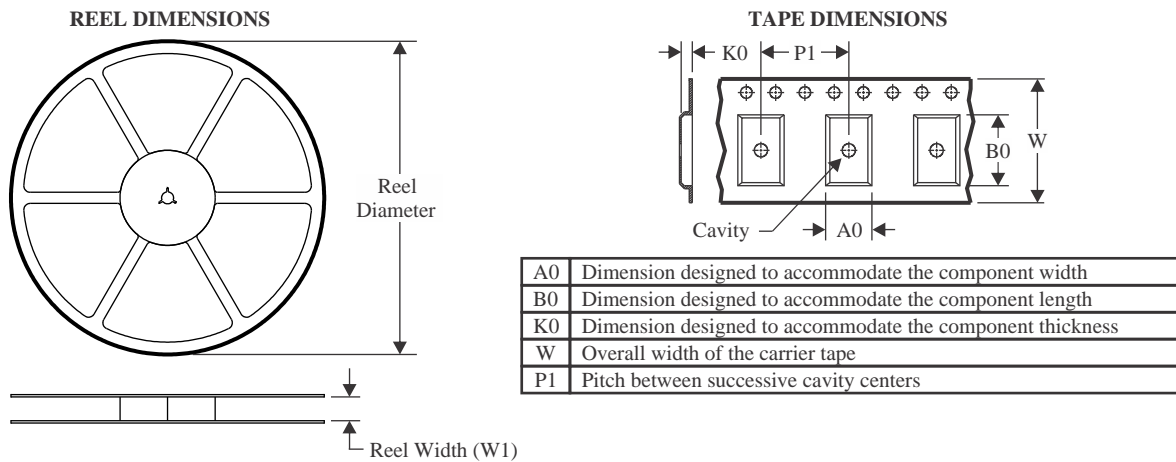
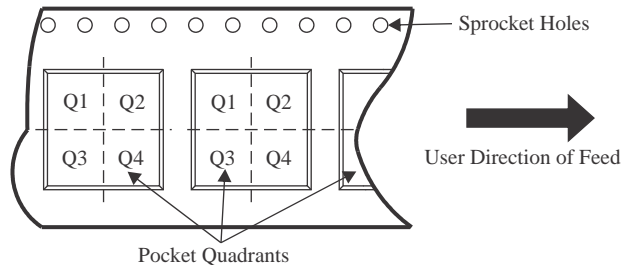
**TAPE AND REEL INFORMATION**

**QUADRANT ASSIGNMENTS FOR PIN 1 ORIENTATION IN TAPE**

\*All dimensions are nominal

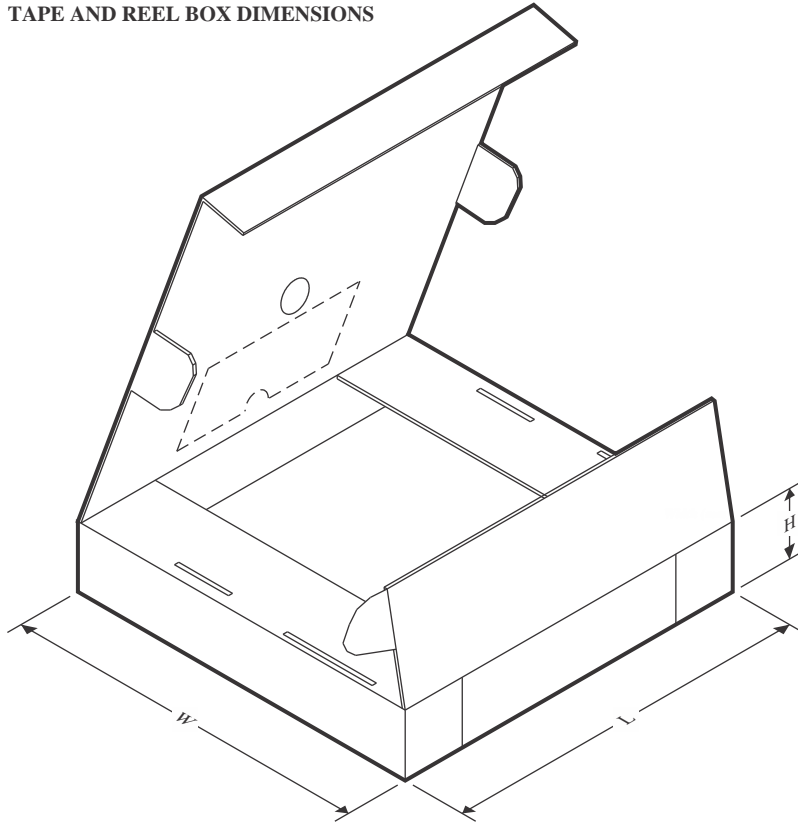
| Device      | Package Type | Package Drawing | Pins | SPQ  | Reel Diameter (mm) | Reel Width W1 (mm) | A0 (mm) | B0 (mm) | K0 (mm) | P1 (mm) | W (mm) | Pin1 Quadrant |
|-------------|--------------|-----------------|------|------|--------------------|--------------------|---------|---------|---------|---------|--------|---------------|
| TLE2081ACDR | SOIC         | D               | 8    | 2500 | 330.0              | 12.4               | 6.4     | 5.2     | 2.1     | 8.0     | 12.0   | Q1            |
| TLE2081CDR  | SOIC         | D               | 8    | 2500 | 330.0              | 12.4               | 6.4     | 5.2     | 2.1     | 8.0     | 12.0   | Q1            |
| TLE2081IDR  | SOIC         | D               | 8    | 2500 | 330.0              | 12.4               | 6.4     | 5.2     | 2.1     | 8.0     | 12.0   | Q1            |
| TLE2082ACDR | SOIC         | D               | 8    | 2500 | 330.0              | 12.4               | 6.4     | 5.2     | 2.1     | 8.0     | 12.0   | Q1            |
| TLE2082AIDR | SOIC         | D               | 8    | 2500 | 330.0              | 12.4               | 6.4     | 5.2     | 2.1     | 8.0     | 12.0   | Q1            |
| TLE2082CDR  | SOIC         | D               | 8    | 2500 | 330.0              | 12.4               | 6.4     | 5.2     | 2.1     | 8.0     | 12.0   | Q1            |
| TLE2082IDR  | SOIC         | D               | 8    | 2500 | 330.0              | 12.4               | 6.4     | 5.2     | 2.1     | 8.0     | 12.0   | Q1            |
| TLE2084CDWR | SOIC         | DW              | 16   | 2000 | 330.0              | 16.4               | 10.75   | 10.7    | 2.7     | 12.0    | 16.0   | Q1            |

**TAPE AND REEL BOX DIMENSIONS**

\*All dimensions are nominal

| Device      | Package Type | Package Drawing | Pins | SPQ  | Length (mm) | Width (mm) | Height (mm) |
|-------------|--------------|-----------------|------|------|-------------|------------|-------------|
| TLE2081ACDR | SOIC         | D               | 8    | 2500 | 340.5       | 338.1      | 20.6        |
| TLE2081CDR  | SOIC         | D               | 8    | 2500 | 340.5       | 338.1      | 20.6        |
| TLE2081IDR  | SOIC         | D               | 8    | 2500 | 340.5       | 338.1      | 20.6        |
| TLE2082ACDR | SOIC         | D               | 8    | 2500 | 340.5       | 338.1      | 20.6        |
| TLE2082AIDR | SOIC         | D               | 8    | 2500 | 340.5       | 338.1      | 20.6        |
| TLE2082CDR  | SOIC         | D               | 8    | 2500 | 340.5       | 338.1      | 20.6        |
| TLE2082IDR  | SOIC         | D               | 8    | 2500 | 340.5       | 338.1      | 20.6        |
| TLE2084CDWR | SOIC         | DW              | 16   | 2000 | 350.0       | 350.0      | 43.0        |

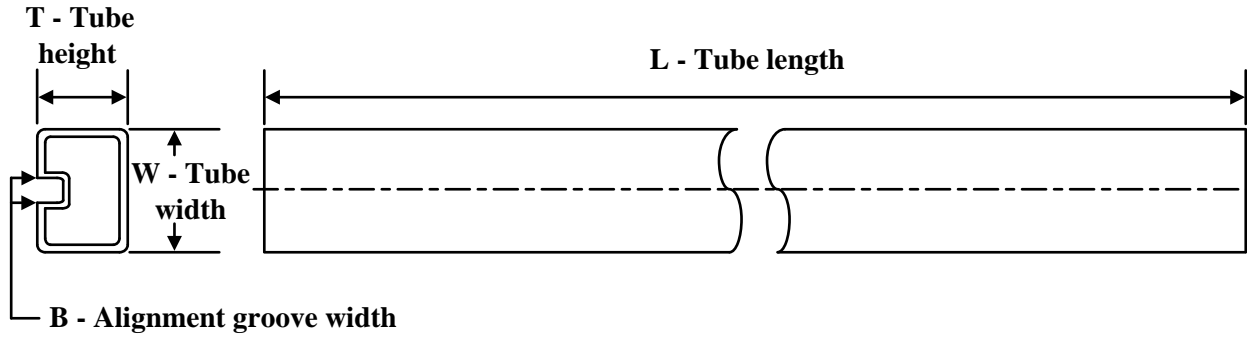
**TUBE**

\*All dimensions are nominal

| Device      | Package Name | Package Type | Pins | SPQ | L (mm) | W (mm) | T (µm) | B (mm) |
|-------------|--------------|--------------|------|-----|--------|--------|--------|--------|
| TLE2081ACP  | P            | PDIP         | 8    | 50  | 506    | 13.97  | 11230  | 4.32   |
| TLE2081AID  | D            | SOIC         | 8    | 75  | 505.46 | 6.76   | 3810   | 4      |
| TLE2081AID  | D            | SOIC         | 8    | 75  | 507    | 8      | 3940   | 4.32   |
| TLE2081AIP  | P            | PDIP         | 8    | 50  | 506    | 13.97  | 11230  | 4.32   |
| TLE2081AIP  | P            | PDIP         | 8    | 50  | 506    | 13.97  | 11230  | 4.32   |
| TLE2081CP   | P            | PDIP         | 8    | 50  | 506    | 13.97  | 11230  | 4.32   |
| TLE2081CP   | P            | PDIP         | 8    | 50  | 506    | 13.97  | 11230  | 4.32   |
| TLE2081IP   | P            | PDIP         | 8    | 50  | 506    | 13.97  | 11230  | 4.32   |
| TLE2082ACP  | P            | PDIP         | 8    | 50  | 506    | 13.97  | 11230  | 4.32   |
| TLE2082ACP  | P            | PDIP         | 8    | 50  | 506    | 13.97  | 11230  | 4.32   |
| TLE2082AIP  | P            | PDIP         | 8    | 50  | 506    | 13.97  | 11230  | 4.32   |
| TLE2082CP   | P            | PDIP         | 8    | 50  | 506    | 13.97  | 11230  | 4.32   |
| TLE2082CP   | P            | PDIP         | 8    | 50  | 506    | 13.97  | 11230  | 4.32   |
| TLE2082IP   | P            | PDIP         | 8    | 50  | 506    | 13.97  | 11230  | 4.32   |
| TLE2084ACDW | DW           | SOIC         | 16   | 40  | 506.98 | 12.7   | 4826   | 6.6    |
| TLE2084ACN  | N            | PDIP         | 14   | 25  | 506    | 13.97  | 11230  | 4.32   |
| TLE2084CDW  | DW           | SOIC         | 16   | 40  | 506.98 | 12.7   | 4826   | 6.6    |
| TLE2084CN   | N            | PDIP         | 14   | 25  | 506    | 13.97  | 11230  | 4.32   |
| TLE2084IDW  | DW           | SOIC         | 16   | 40  | 506.98 | 12.7   | 4826   | 6.6    |

## GENERIC PACKAGE VIEW

**DW 16**

**SOIC - 2.65 mm max height**

7.5 x 10.3, 1.27 mm pitch

SMALL OUTLINE INTEGRATED CIRCUIT

This image is a representation of the package family, actual package may vary.  
Refer to the product data sheet for package details.

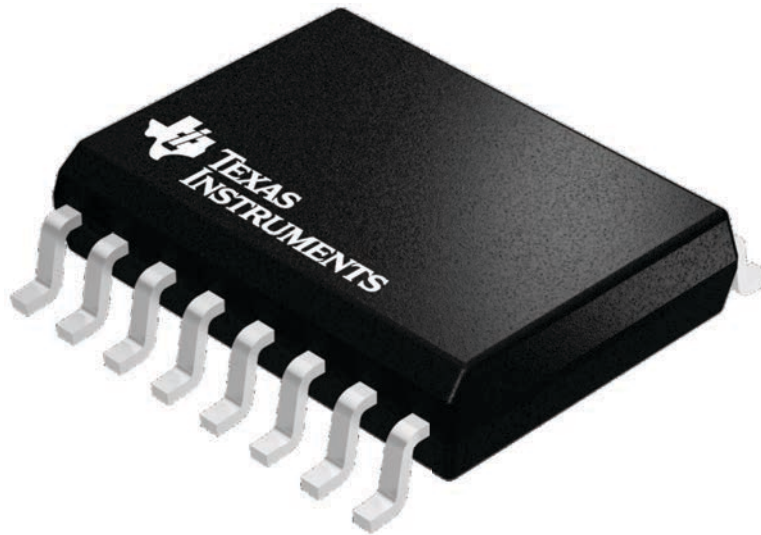

4224780/A

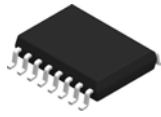

# DW0016A

# PACKAGE OUTLINE SOIC - 2.65 mm max height

SOIC

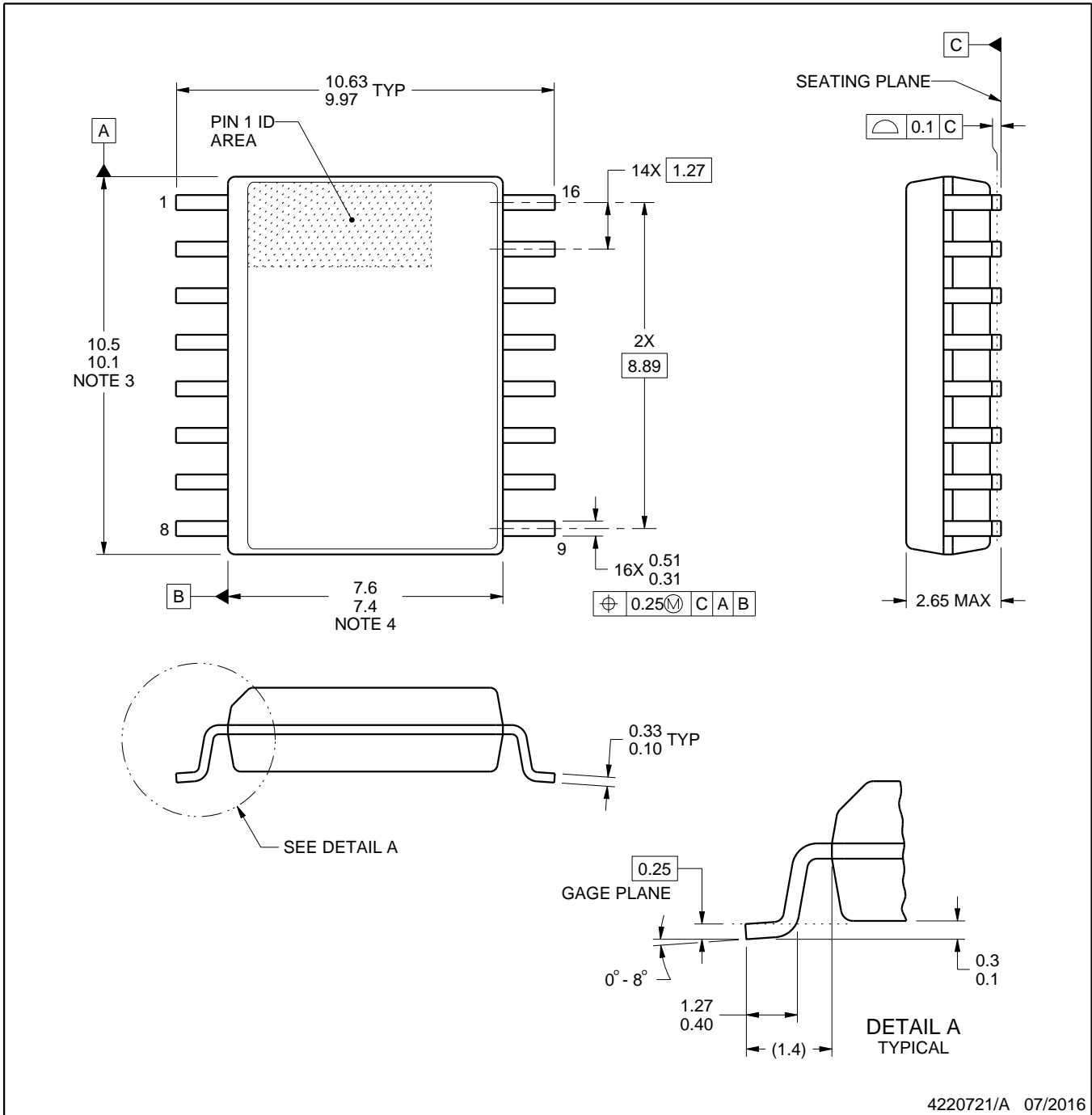

4220721/A 07/2016

### NOTES:

1. All linear dimensions are in millimeters. Dimensions in parenthesis are for reference only. Dimensioning and tolerancing per ASME Y14.5M.
2. This drawing is subject to change without notice.
3. This dimension does not include mold flash, protrusions, or gate burrs. Mold flash, protrusions, or gate burrs shall not exceed 0.15 mm, per side.
4. This dimension does not include interlead flash. Interlead flash shall not exceed 0.25 mm, per side.
5. Reference JEDEC registration MS-013.

# EXAMPLE BOARD LAYOUT

DW0016A

SOIC - 2.65 mm max height

SOIC

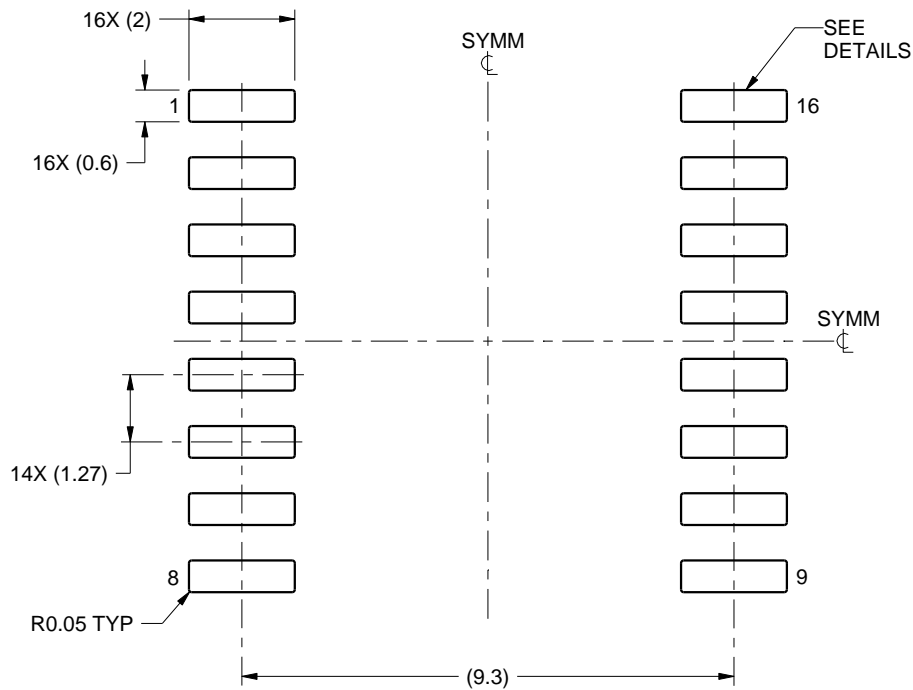

LAND PATTERN EXAMPLE  
SCALE:7X

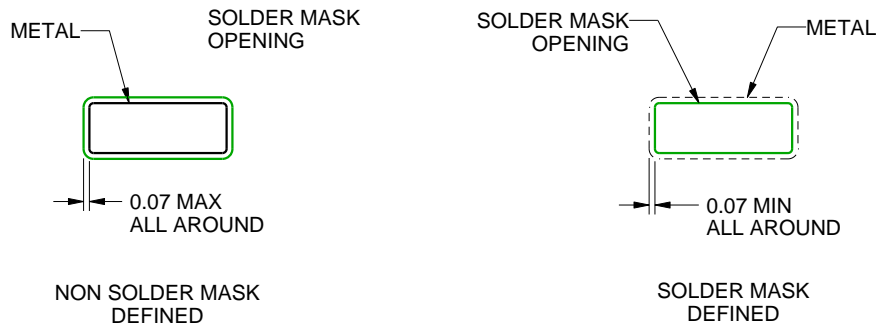

SOLDER MASK DETAILS

4220721/A 07/2016

NOTES: (continued)

- 6. Publication IPC-7351 may have alternate designs.
- 7. Solder mask tolerances between and around signal pads can vary based on board fabrication site.

# EXAMPLE STENCIL DESIGN

DW0016A

SOIC - 2.65 mm max height

SOIC

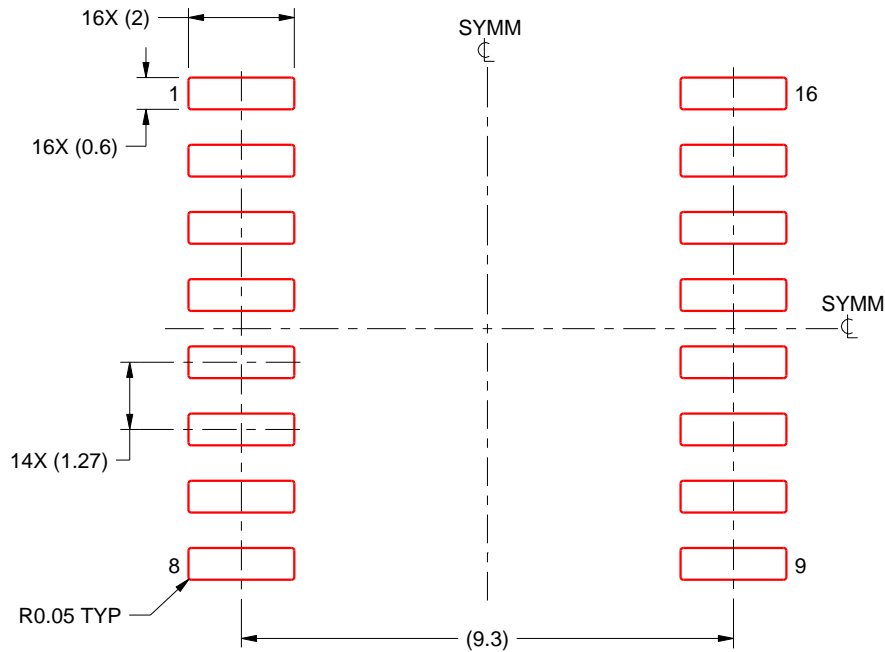

SOLDER PASTE EXAMPLE  
BASED ON 0.125 mm THICK STENCIL  
SCALE:7X

4220721/A 07/2016

NOTES: (continued)

8. Laser cutting apertures with trapezoidal walls and rounded corners may offer better paste release. IPC-7525 may have alternate design recommendations.
9. Board assembly site may have different recommendations for stencil design.



D0008A

# PACKAGE OUTLINE

SOIC - 1.75 mm max height

SMALL OUTLINE INTEGRATED CIRCUIT



4214825/C 02/2019

### NOTES:

- Linear dimensions are in inches [millimeters]. Dimensions in parenthesis are for reference only. Controlling dimensions are in inches. Dimensioning and tolerancing per ASME Y14.5M.
- This drawing is subject to change without notice.
- This dimension does not include mold flash, protrusions, or gate burrs. Mold flash, protrusions, or gate burrs shall not exceed  $.006$  [0.15] per side.
- This dimension does not include interlead flash.
- Reference JEDEC registration MS-012, variation AA.

# EXAMPLE BOARD LAYOUT

D0008A

SOIC - 1.75 mm max height

SMALL OUTLINE INTEGRATED CIRCUIT



LAND PATTERN EXAMPLE  
EXPOSED METAL SHOWN  
SCALE:8X



SOLDER MASK DETAILS

4214825/C 02/2019

NOTES: (continued)

- 6. Publication IPC-7351 may have alternate designs.
- 7. Solder mask tolerances between and around signal pads can vary based on board fabrication site.

# EXAMPLE STENCIL DESIGN

D0008A

SOIC - 1.75 mm max height

SMALL OUTLINE INTEGRATED CIRCUIT



SOLDER PASTE EXAMPLE  
BASED ON .005 INCH [0.125 MM] THICK STENCIL  
SCALE:8X

4214825/C 02/2019

NOTES: (continued)

8. Laser cutting apertures with trapezoidal walls and rounded corners may offer better paste release. IPC-7525 may have alternate design recommendations.
9. Board assembly site may have different recommendations for stencil design.

P (R-PDIP-T8)

PLASTIC DUAL-IN-LINE PACKAGE

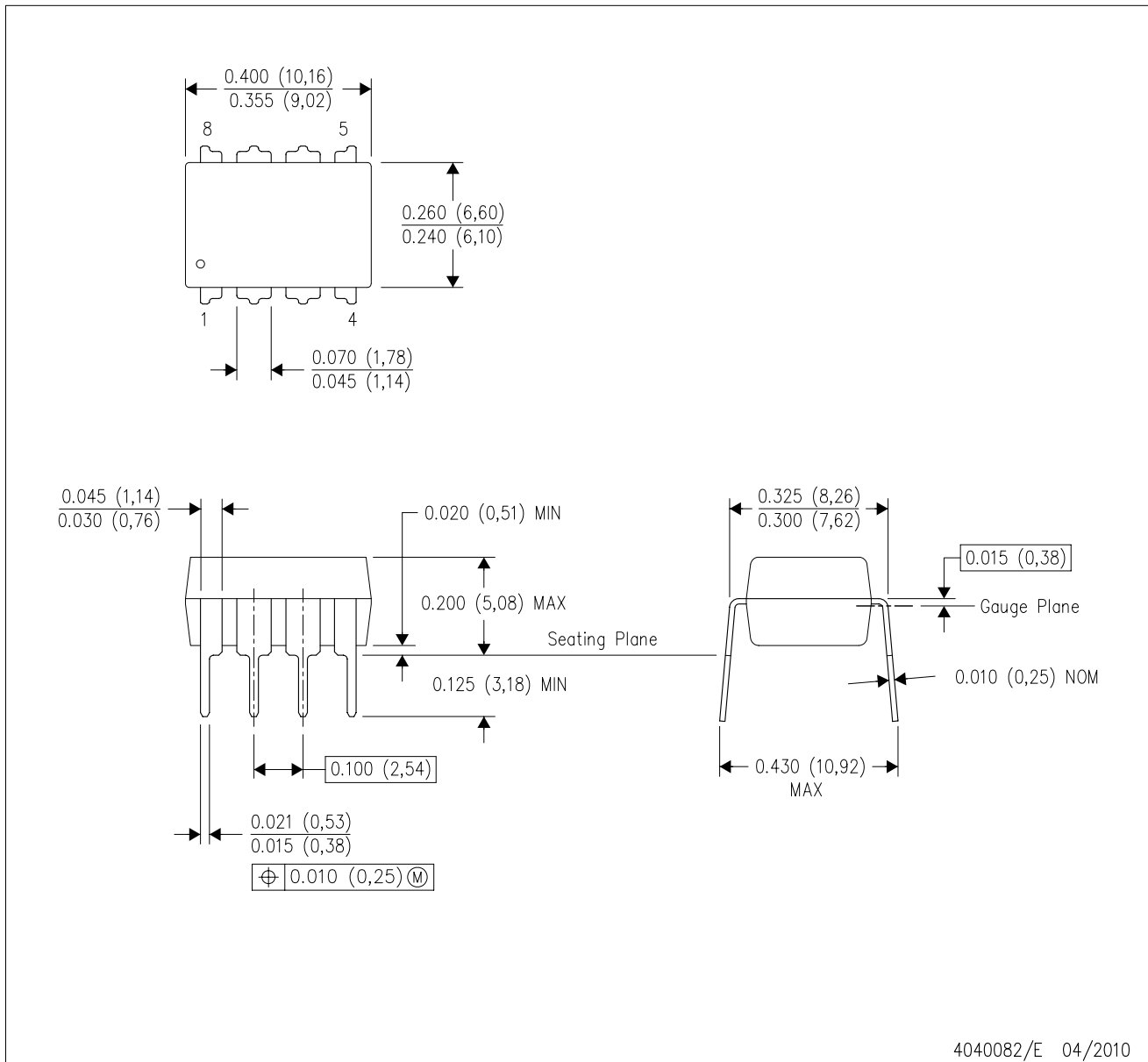

4040082/E 04/2010

- NOTES:
- A. All linear dimensions are in inches (millimeters).
  - B. This drawing is subject to change without notice.
  - C. Falls within JEDEC MS-001 variation BA.

N (R-PDIP-T\*\*)

PLASTIC DUAL-IN-LINE PACKAGE

16 PINS SHOWN

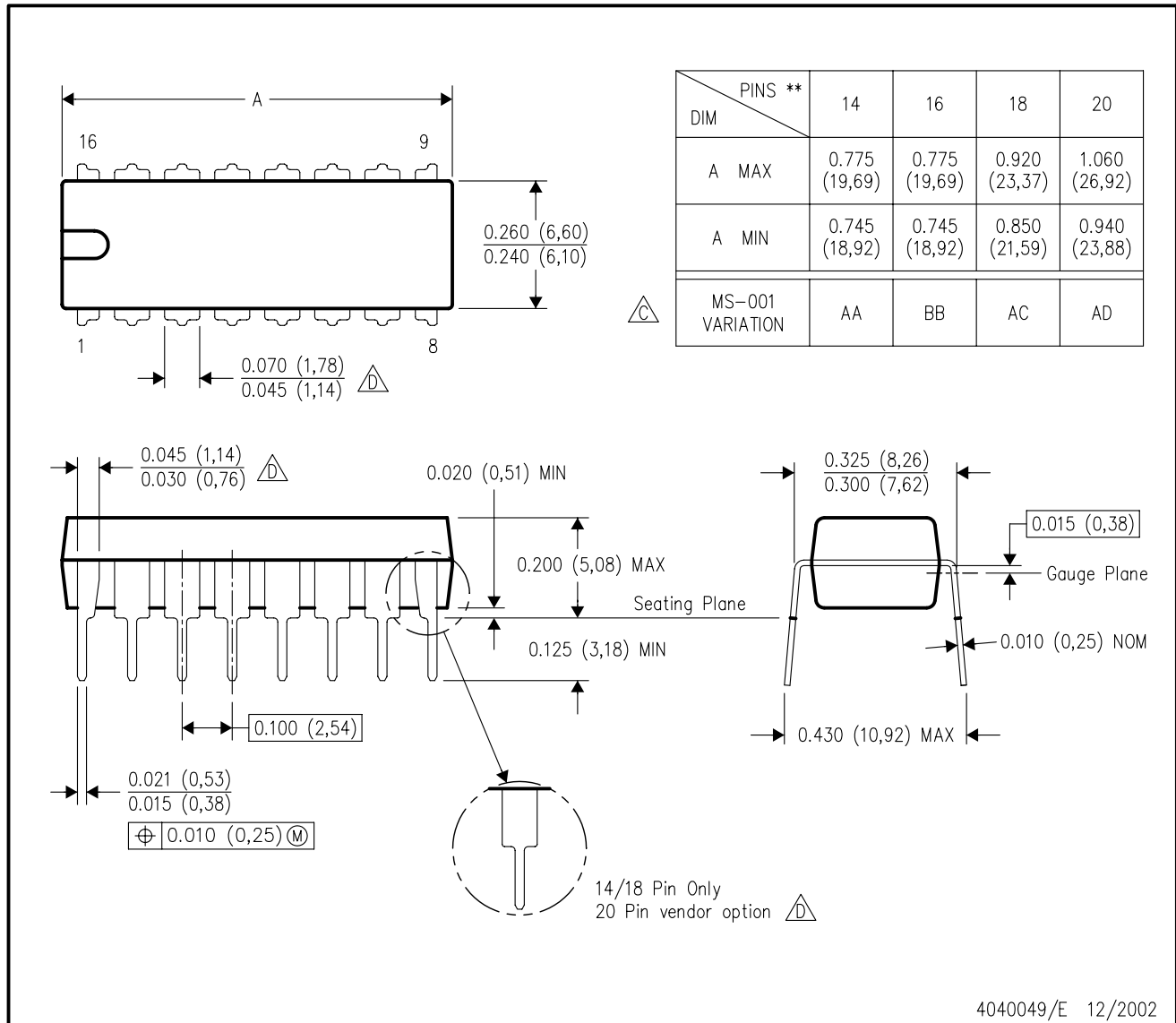

- NOTES:
- A. All linear dimensions are in inches (millimeters).
  - B. This drawing is subject to change without notice.
  - Falls within JEDEC MS-001, except 18 and 20 pin minimum body length (Dim A).
  - The 20 pin end lead shoulder width is a vendor option, either half or full width.

## IMPORTANT NOTICE AND DISCLAIMER

TI PROVIDES TECHNICAL AND RELIABILITY DATA (INCLUDING DATA SHEETS), DESIGN RESOURCES (INCLUDING REFERENCE DESIGNS), APPLICATION OR OTHER DESIGN ADVICE, WEB TOOLS, SAFETY INFORMATION, AND OTHER RESOURCES "AS IS" AND WITH ALL FAULTS, AND DISCLAIMS ALL WARRANTIES, EXPRESS AND IMPLIED, INCLUDING WITHOUT LIMITATION ANY IMPLIED WARRANTIES OF MERCHANTABILITY, FITNESS FOR A PARTICULAR PURPOSE OR NON-INFRINGEMENT OF THIRD PARTY INTELLECTUAL PROPERTY RIGHTS.

These resources are intended for skilled developers designing with TI products. You are solely responsible for (1) selecting the appropriate TI products for your application, (2) designing, validating and testing your application, and (3) ensuring your application meets applicable standards, and any other safety, security, regulatory or other requirements.

These resources are subject to change without notice. TI grants you permission to use these resources only for development of an application that uses the TI products described in the resource. Other reproduction and display of these resources is prohibited. No license is granted to any other TI intellectual property right or to any third party intellectual property right. TI disclaims responsibility for, and you will fully indemnify TI and its representatives against, any claims, damages, costs, losses, and liabilities arising out of your use of these resources.

TI's products are provided subject to [TI's Terms of Sale](#) or other applicable terms available either on [ti.com](https://www.ti.com) or provided in conjunction with such TI products. TI's provision of these resources does not expand or otherwise alter TI's applicable warranties or warranty disclaimers for TI products.

TI objects to and rejects any additional or different terms you may have proposed.

Mailing Address: Texas Instruments, Post Office Box 655303, Dallas, Texas 75265  
Copyright © 2024, Texas Instruments Incorporated

## Looking for pricing, stock, or lifecycle information?

Click below to explore more details on WIN SOURCE:

 [View TLE2082IP](#) on WIN SOURCE

 [Texas Instruments](#) Information

## Optimize Your Supply Chain with WIN SOURCE Solutions

-  Global Sourcing Solution
-  Obsolete Management
-  Cost Control Management
-  Shortage Management
-  Alternative Solution
-  Excess Inventory Management