



**THE DATASHEET OF
MRF6V10010NR4**



RF Power Field Effect Transistor

N-Channel Enhancement-Mode Lateral MOSFET

RF Power transistor designed for applications operating at frequencies between 960 and 1400 MHz, 1% to 20% duty cycle. This device is suitable for use in pulsed applications.

- Typical Pulsed Performance: $V_{DD} = 50$ Volts, $I_{DQ} = 10$ mA, $P_{out} = 10$ Watts Peak (2 W Avg.), $f = 1090$ MHz, Pulse Width = 100 μ sec, Duty Cycle = 20%
Power Gain — 25 dB
Drain Efficiency — 69%

Features

- Characterized with Series Equivalent Large-Signal Impedance Parameters
- Qualified Up to a Maximum of 50 V_{DD} Operation
- Integrated ESD Protection
- Greater Negative Gate-Source Voltage Range for Improved Class C Operation
- RoHS Compliant
- In Tape and Reel. R4 Suffix = 100 Units per 12 mm, 7 inch Reel.

MRF6V10010NR4

**1090 MHz, 10 W, 50 V
PULSED
LATERAL N-CHANNEL
RF POWER MOSFET**

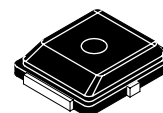

**CASE 466-03, STYLE 1
PLD-1.5
PLASTIC**

Table 1. Maximum Ratings

Rating	Symbol	Value	Unit
Drain-Source Voltage	V_{DSS}	-0.5, +100	Vdc
Gate-Source Voltage	V_{GS}	-6.0, +10	Vdc
Storage Temperature Range	T_{stg}	-65 to +150	$^{\circ}$ C
Case Operating Temperature	T_C	150	$^{\circ}$ C
Operating Junction Temperature	T_J	200	$^{\circ}$ C

Table 2. Thermal Characteristics

Characteristic	Symbol	Value (1,2)	Unit
Thermal Resistance, Junction to Case Case Temperature 79 $^{\circ}$ C, 10 W Pulsed, 100 μ sec Pulse Width, 20% Duty Cycle	$Z_{\theta JC}$	1.6	$^{\circ}$ C/W

1. MTTF calculator available at <http://www.freescale.com/rf>. Select Software & Tools/Development Tools/Calculators to access MTTF calculators by product.
2. Refer to AN1955, *Thermal Measurement Methodology of RF Power Amplifiers*. Go to <http://www.freescale.com/rf>. Select Documentation/Application Notes - AN1955.

Table 3. ESD Protection Characteristics

Test Methodology	Class
Human Body Model (per JESD22-A114)	1C (Minimum)
Machine Model (per EIA/JESD22-A115)	A (Minimum)
Charge Device Model (per JESD22-C101)	IV (Minimum)

Table 4. Moisture Sensitivity Level

Test Methodology	Rating	Package Peak Temperature	Unit
Per JESD22-A113, IPC/JEDEC J-STD-020	3	260	°C

Table 5. Electrical Characteristics ($T_A = 25^\circ\text{C}$ unless otherwise noted)

Characteristic	Symbol	Min	Typ	Max	Unit
----------------	--------	-----	-----	-----	------

Off Characteristics

Gate-Source Leakage Current ($V_{GS} = 5\text{ Vdc}$, $V_{DS} = 0\text{ Vdc}$)	I_{GSS}	—	—	10	μAdc
Drain-Source Breakdown Voltage ($V_{GS} = 0\text{ Vdc}$, $I_D = 7\text{ mA}$)	$V_{(BR)DSS}$	100	—	—	Vdc
Zero Gate Voltage Drain Leakage Current ($V_{DS} = 50\text{ Vdc}$, $V_{GS} = 0\text{ Vdc}$)	I_{DSS}	—	—	50	μAdc
Zero Gate Voltage Drain Leakage Current ($V_{DS} = 100\text{ Vdc}$, $V_{GS} = 0\text{ Vdc}$)	I_{DSS}	—	—	2.5	mA

On Characteristics

Gate Threshold Voltage ($V_{DS} = 10\text{ Vdc}$, $I_D = 36\ \mu\text{Adc}$)	$V_{GS(th)}$	1	1.7	2.5	Vdc
Gate Quiescent Voltage ($V_{DD} = 50\text{ Vdc}$, $I_D = 10\text{ mAdc}$, Measured in Functional Test)	$V_{GS(Q)}$	1.7	2.4	3.2	Vdc
Drain-Source On-Voltage ($V_{GS} = 10\text{ Vdc}$, $I_D = 70\text{ mAdc}$)	$V_{DS(on)}$	—	0.2	—	Vdc

Dynamic Characteristics

Reverse Transfer Capacitance ($V_{DS} = 50\text{ Vdc} \pm 30\text{ mV(rms)ac}$ @ 1 MHz, $V_{GS} = 0\text{ Vdc}$)	C_{rss}	—	0.1	—	pF
Output Capacitance ($V_{DS} = 50\text{ Vdc} \pm 30\text{ mV(rms)ac}$ @ 1 MHz, $V_{GS} = 0\text{ Vdc}$)	C_{oss}	—	3.38	—	pF
Input Capacitance ($V_{DS} = 50\text{ Vdc}$, $V_{GS} = 0\text{ Vdc} \pm 30\text{ mV(rms)ac}$ @ 1 MHz)	C_{iss}	—	9.55	—	pF

Functional Tests (In Freescale Test Fixture, 50 ohm system) $V_{DD} = 50\text{ Vdc}$, $I_{DQ} = 10\text{ mA}$, $P_{out} = 10\text{ W Peak}$ (2 W Avg.), $f = 1090\text{ MHz}$, Pulsed, 100 μsec Pulse Width, 20% Duty Cycle

Power Gain	G_{ps}	23	25	28	dB
Drain Efficiency	η_D	66	69	—	%
Input Return Loss	IRL	—	-12	-8	dB

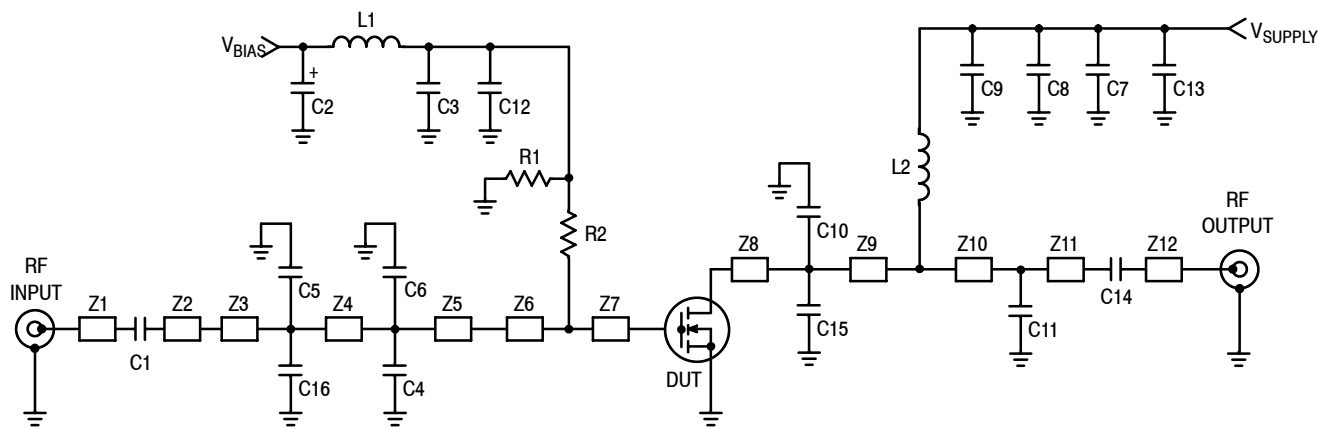

Z1	0.200" x 0.080" Microstrip	Z8	0.367" x 0.320" Microstrip
Z2	0.696" x 0.120" Microstrip	Z9	0.162" x 0.320" Microstrip
Z3	0.087" x 0.320" Microstrip	Z10	0.757" x 0.080" Microstrip
Z4	0.323" x 0.320" Microstrip	Z11	0.763" x 0.080" Microstrip
Z5	0.320" x 0.620" x 0.185" Taper	Z12	0.290" x 0.080" Microstrip
Z6	0.135" x 0.620" Microstrip	PCB	Arlon CuClad 250GX-0300-55-22, 0.030", $\epsilon_r = 2.55$
Z7	0.714" x 0.620" Microstrip		

Figure 1. MR6V1001NR4 Test Circuit Schematic

Table 6. MR6V1001NR4 Test Circuit Component Designations and Values

Part	Description	Part Number	Manufacturer
C1, C9, C12	43 pF Chip Capacitors	ATC100B430JT500XT	ATC
C2	10 μ F, 35 V Tantalum Capacitor	T491D106K035AT	Kemet
C3, C8	2.2 μ F, 100 V Chip Capacitors	GQM1885C2A2R2CB01B	Murata
C4, C6	7.5 pF Chip Capacitors	ATC100B7R5CT500XT	ATC
C5, C16	3.0 pF Chip Capacitors	ATC100B3R0CT500XT	ATC
C7	0.1 μ F Chip Capacitor	C1206C104K5RACTR	Kemet
C10, C15	0.3 pF Chip Capacitors	ATC100B0R3BT500XT	ATC
C11	5.6 pF Chip Capacitor	ATC100B5R6CT500XT	ATC
C13	470 μ F, 63 V Chip Capacitor	477KXM063M	Illinois Capacitor
C14	47 pF Chip Capacitor	ATC100B470JT500XT	ATC
L1	8 nH Inductor	A03TKLC	Coilcraft
L2	5 nH Inductor	A02TKLC	Coilcraft
R1	3300 Ω , 1/4 W Chip Resistor	CRCW12063301FKEA	Vishay
R2	10 Ω , 1/4 W Chip Resistor	CRCW120610R0FKEA	Vishay

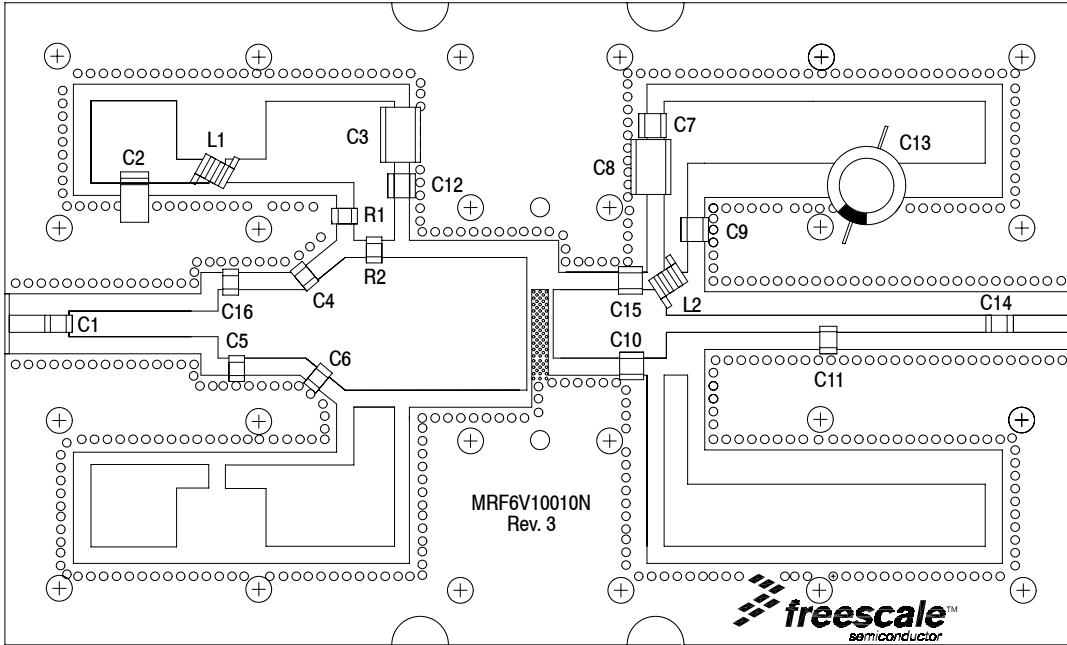

Figure 2. MRF6V10010NR4 Test Circuit Component Layout

TYPICAL CHARACTERISTICS

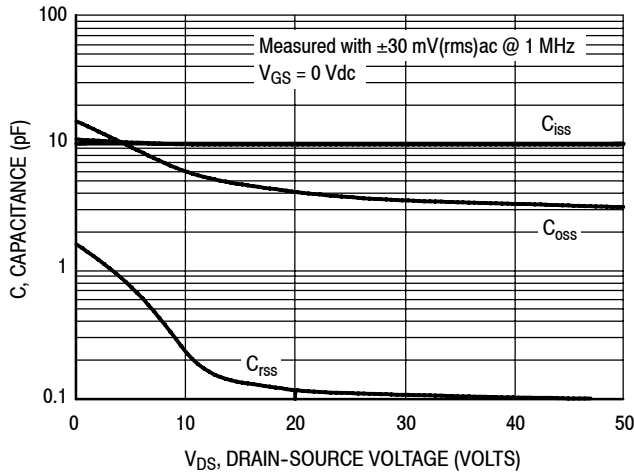

Figure 3. Capacitance versus Drain-Source Voltage

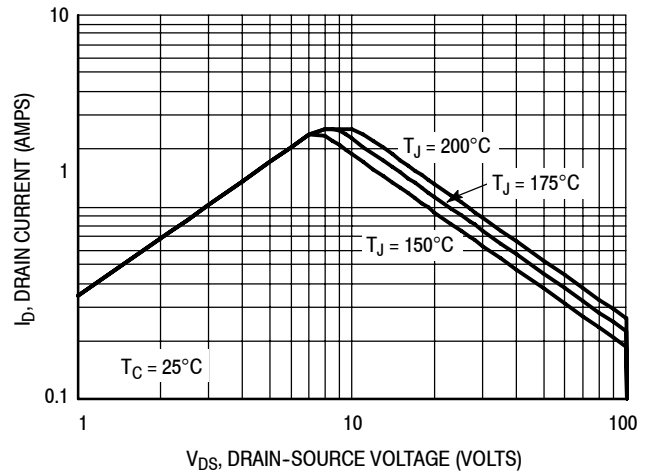

Figure 4. DC Safe Operating Area

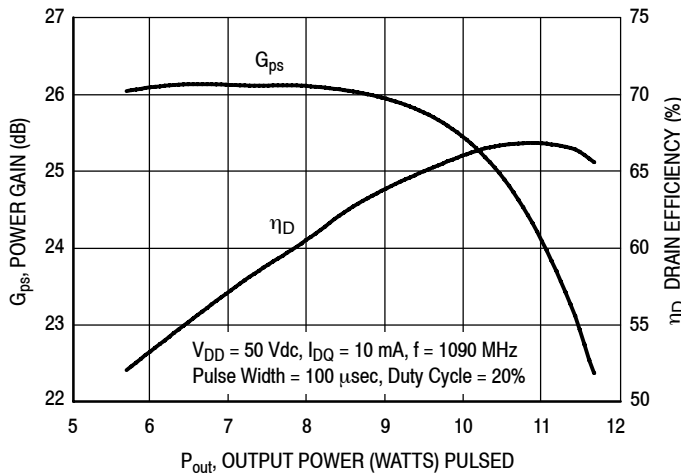

Figure 5. Pulsed Power Gain and Drain Efficiency versus Output Power

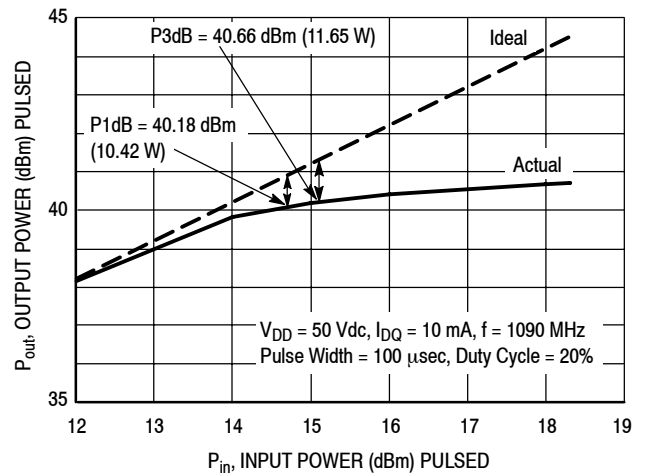

Figure 6. Pulsed Output Power versus Input Power

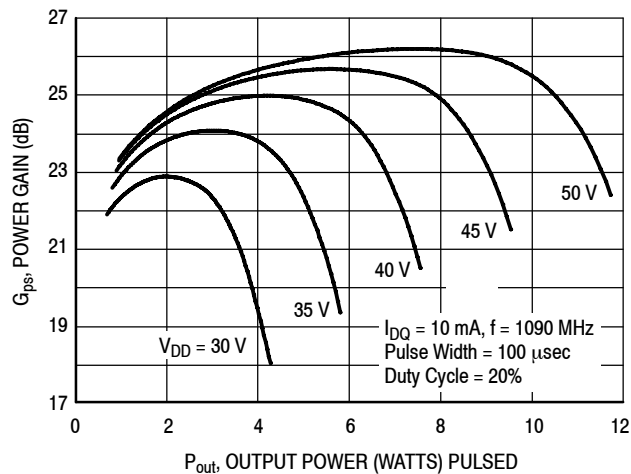

Figure 7. Pulsed Power Gain versus Output Power

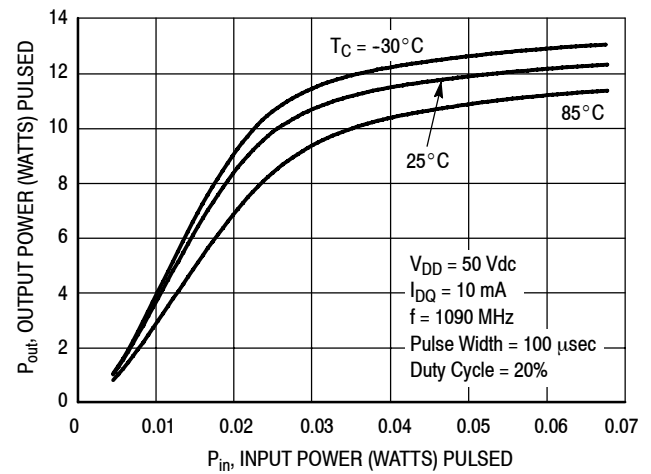

Figure 8. Pulsed Output Power versus Input Power

TYPICAL CHARACTERISTICS

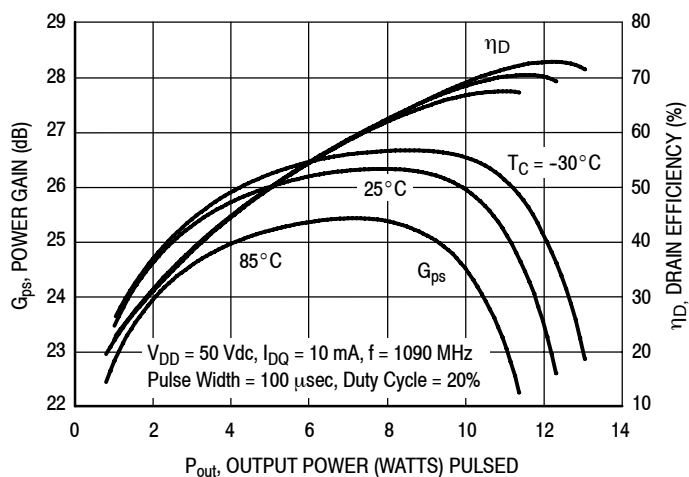
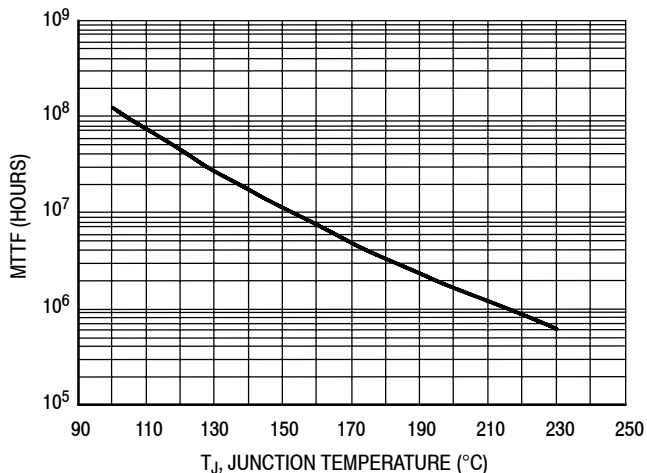

Figure 9. Pulsed Power Gain and Drain Efficiency versus Output Power



This above graph displays calculated MTTF in hours when the device is operated at $V_{DD} = 50$ Vdc, $P_{out} = 10$ W Peak, Pulse Width = 100 μ sec, Duty Cycle = 20%, and $\eta_D = 69\%$.

MTTF calculator available at <http://www.freescale.com/rf>. Select Software & Tools/Development Tools/Calculators to access MTTF calculators by product.

Figure 10. MTTF versus Junction Temperature

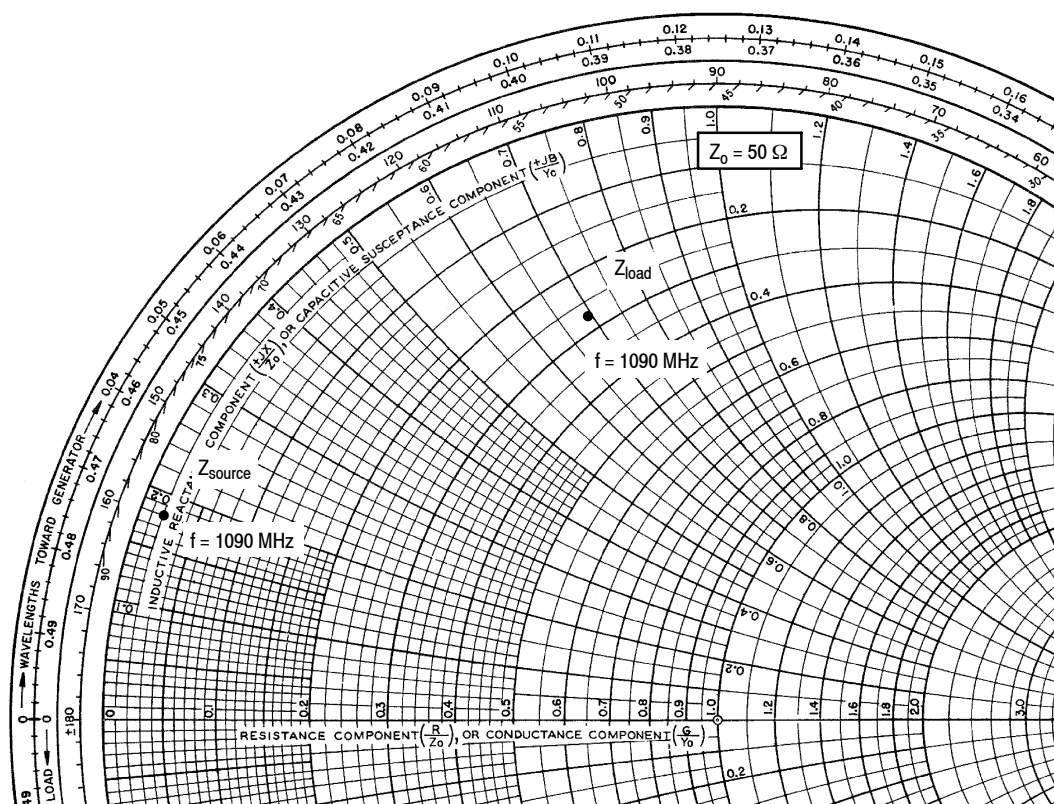

$V_{DD} = 50 \text{ Vdc}$, $I_{DQ} = 10 \text{ mA}$, $P_{out} = 10 \text{ W Peak}$

f MHz	Z_{source} Ω	Z_{load} Ω
1090	$1.15 + j8.96$	$13.47 + j34.32$

Z_{source} = Test circuit impedance as measured from gate to ground.

Z_{load} = Test circuit impedance as measured from drain to ground.

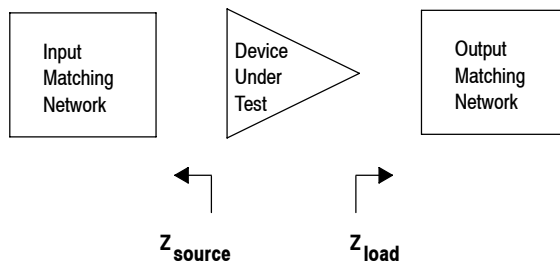
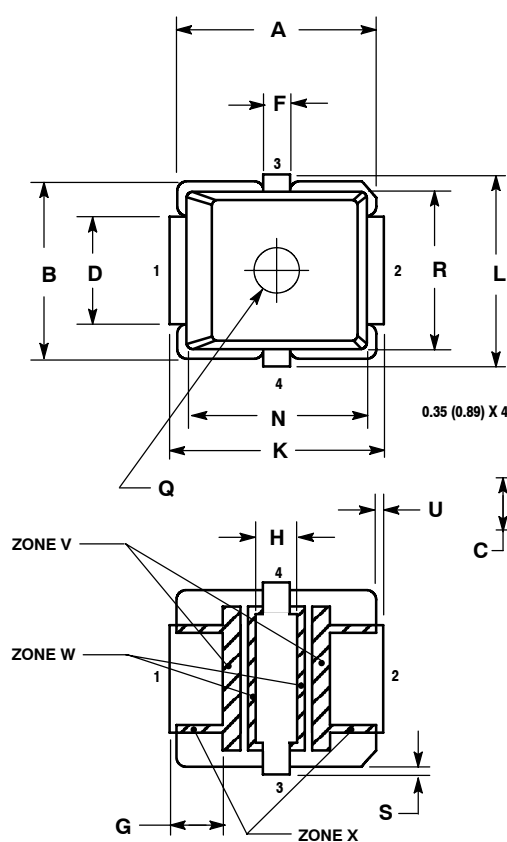
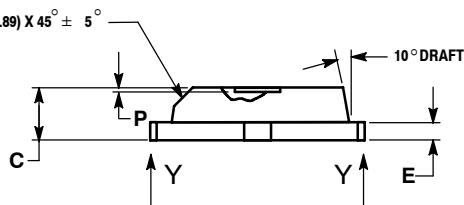

Figure 11. Series Equivalent Source and Load Impedance

PACKAGE DIMENSIONS



VIEW Y-Y



NOTES:

1. INTERPRET DIMENSIONS AND TOLERANCES PER ASME Y14.5M, 1984.
2. CONTROLLING DIMENSION: INCH
3. RESIN BLEED/FLASH ALLOWABLE IN ZONE V, W, AND X.

STYLE 1:

- PIN 1. DRAIN
2. GATE
3. SOURCE
4. SOURCE

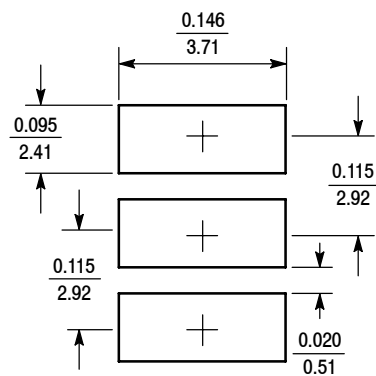

(inches)
mm

SOLDER FOOTPRINT

DIM	INCHES		MILLIMETERS	
	MIN	MAX	MIN	MAX
A	0.255	0.265	6.48	6.73
B	0.225	0.235	5.72	5.97
C	0.065	0.072	1.65	1.83
D	0.130	0.150	3.30	3.81
E	0.021	0.026	0.53	0.66
F	0.026	0.044	0.66	1.12
G	0.050	0.070	1.27	1.78
H	0.045	0.063	1.14	1.60
J	0.160	0.180	4.06	4.57
K	0.273	0.285	6.93	7.24
L	0.245	0.255	6.22	6.48
N	0.230	0.240	5.84	6.10
P	0.000	0.008	0.00	0.20
Q	0.055	0.063	1.40	1.60
R	0.200	0.210	5.08	5.33
S	0.006	0.012	0.15	0.31
U	0.006	0.012	0.15	0.31
ZONE V	0.000	0.021	0.00	0.53
ZONE W	0.000	0.010	0.00	0.25
ZONE X	0.000	0.010	0.00	0.25

**CASE 466-03
ISSUE D
PLD-1.5
PLASTIC**

PRODUCT DOCUMENTATION AND SOFTWARE

Refer to the following documents to aid your design process.

Application Notes

- AN1955: Thermal Measurement Methodology of RF Power Amplifiers

Engineering Bulletins

- EB212: Using Data Sheet Impedances for RF LDMOS Devices

Software

- Electromigration MTTF Calculator

For Software, do a Part Number search at <http://www.freescale.com>, and select the “Part Number” link. Go to the Software & Tools tab on the part’s Product Summary page to download the respective tool.

REVISION HISTORY

The following table summarizes revisions to this document.

Revision	Date	Description
0	June 2008	<ul style="list-style-type: none"> • Initial Release of Data Sheet
1	Feb. 2009	<ul style="list-style-type: none"> • Corrected Z_{source}, “2.57 - j7.33” to “1.15 + j8.96” and Z_{load}, “14.10 - j34.77” to “13.47 + j34.32” in Fig. 11, Series Equivalent Source and Load Impedance data table and replotted data, p. 7
2	June 2009	<ul style="list-style-type: none"> • Modified data sheet to reflect MSL rating change from 1 to 3 as a result of the standardization of packing process as described in Product and Process Change Notification number, PCN13516, p. 2 • Added Electromigration MTTF Calculator availability to Product Documentation, Tools and Software, p. 9
3	July 2010	<ul style="list-style-type: none"> • Reporting of pulsed thermal data now shown using the $Z_{\theta JC}$ symbol, Table 2, Thermal Characteristics, p. 1 • Corrected errors made in the translation of the printed circuit board to the schematic, Fig. 1, Test Circuit Schematic and Z list, p. 3

How to Reach Us:

Home Page:

www.freescale.com

Web Support:

<http://www.freescale.com/support>

USA/Europe or Locations Not Listed:

Freescale Semiconductor, Inc.
Technical Information Center, EL516
2100 East Elliot Road
Tempe, Arizona 85284
1-800-521-6274 or +1-480-768-2130
www.freescale.com/support

Europe, Middle East, and Africa:

Freescale Halbleiter Deutschland GmbH
Technical Information Center
Schatzbogen 7
81829 Muenchen, Germany
+44 1296 380 456 (English)
+46 8 52200080 (English)
+49 89 92103 559 (German)
+33 1 69 35 48 48 (French)
www.freescale.com/support

Japan:

Freescale Semiconductor Japan Ltd.
Headquarters
ARCO Tower 15F
1-8-1, Shimo-Meguro, Meguro-ku,
Tokyo 153-0064
Japan
0120 191014 or +81 3 5437 9125
support.japan@freescale.com

Asia/Pacific:

Freescale Semiconductor China Ltd.
Exchange Building 23F
No. 118 Jianguo Road
Chaoyang District
Beijing 100022
China
+86 10 5879 8000
support.asia@freescale.com

For Literature Requests Only:

Freescale Semiconductor Literature Distribution Center
1-800-441-2447 or +1-303-675-2140
Fax: +1-303-675-2150
LDCForFreescaleSemiconductor@hibbertgroup.com

Information in this document is provided solely to enable system and software implementers to use Freescale Semiconductor products. There are no express or implied copyright licenses granted hereunder to design or fabricate any integrated circuits or integrated circuits based on the information in this document.

Freescale Semiconductor reserves the right to make changes without further notice to any products herein. Freescale Semiconductor makes no warranty, representation or guarantee regarding the suitability of its products for any particular purpose, nor does Freescale Semiconductor assume any liability arising out of the application or use of any product or circuit, and specifically disclaims any and all liability, including without limitation consequential or incidental damages. "Typical" parameters that may be provided in Freescale Semiconductor data sheets and/or specifications can and do vary in different applications and actual performance may vary over time. All operating parameters, including "Typicals", must be validated for each customer application by customer's technical experts. Freescale Semiconductor does not convey any license under its patent rights nor the rights of others. Freescale Semiconductor products are not designed, intended, or authorized for use as components in systems intended for surgical implant into the body, or other applications intended to support or sustain life, or for any other application in which the failure of the Freescale Semiconductor product could create a situation where personal injury or death may occur. Should Buyer purchase or use Freescale Semiconductor products for any such unintended or unauthorized application, Buyer shall indemnify and hold Freescale Semiconductor and its officers, employees, subsidiaries, affiliates, and distributors harmless against all claims, costs, damages, and expenses, and reasonable attorney fees arising out of, directly or indirectly, any claim of personal injury or death associated with such unintended or unauthorized use, even if such claim alleges that Freescale Semiconductor was negligent regarding the design or manufacture of the part.

Freescale™ and the Freescale logo are trademarks of Freescale Semiconductor, Inc. All other product or service names are the property of their respective owners.

© Freescale Semiconductor, Inc. 2008-2010. All rights reserved.

Looking for pricing, stock, or lifecycle information?

Click below to explore more details on WIN SOURCE:

 [View MRF6V10010NR4 on WIN SOURCE](#)

 [NXP / Nexperia Information](#)

Optimize Your Supply Chain with WIN SOURCE Solutions

-  Global Sourcing Solution
-  Obsolete Management
-  Cost Control Management
-  Shortage Management
-  Alternative Solution
-  Excess Inventory Management