



**THE DATASHEET OF  
AP78L05SG-13**



**Features**

- 5.0V output voltage with tolerances of  $\pm 5\%$  over the operating temperature ranges
- Output current in excess of 100mA
- Internal thermal overload protection
- Output transistor safe area protection
- Internal short circuit current limiting
- No external components
- Available in plastic TO92-3L, SOT89-3L and plastic SOP-8L low profile packages
- Lead-free Package: TO92-3L (Note 1)
- SOP-8L and SOT89-3L: Available in "Green" Molding Compound (No Br, Sb) (Note 2)
- Lead Free Finish / RoHS Compliant (Note 3)

**General Description**

The AP78L05 is a three terminal positive regulator available with fixed output voltages. It can be used in a wide range of applications. It can provide local on-card regulation, eliminating the distribution problems associated with single point regulation. The voltages available allow the AP78L05 to be used in logic systems, instrumentation, HiFi, and other solid state electronic equipments.



The AP78L05 is available in the plastic TO92-3L, SOT89-3L and SOP-8L using industrial standard package technology. The regulator can deliver 100mA output current with adequate heat sinking. Current limiting is included to limit the peak output current to a safe value. Safe area protection for the output transistors is provided to limit internal power dissipation. Thermal overload protection is integrated to prevent the IC from overheat due to abnormal condition.

**Applications**

- Communication
- CD-ROM
- DVD-Player
- Set-Top Box

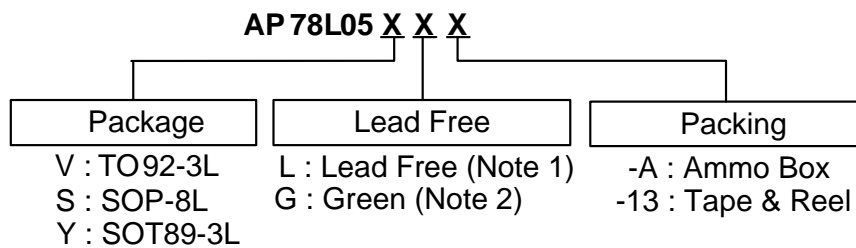
**Ordering Information**



Device	Package Code	Packaging (Note 4)	Ammo Box / Tube		13" Tape and Reel	
			Quantity	Part Number Suffix	Quantity	Part Number Suffix
 AP78L05V	V	TO92-3L	2000/Box	-A	NA	NA
 AP78L05S	S	SOP-8L	NA	NA	2500/Tape & Reel	-13
 AP78L05Y	Y	SOT89-3L	NA	NA	2500/Tape & Reel	-13

Notes: 1. TO92-3L is available in "Lead Free" product only.  
 2. SOP-8L and SOT89-3L are available in "Green" product only.  
 3. RoHS revision 13.2.2003. Glass and high temperature solder exemptions applied, see *EU Directive Annex Notes 5 and 7*.  
 4. Pad layout as shown on Diodes Inc. suggested pad layout document AP02001, which can be found on our website at <http://www.diodes.com/datasheets/ap02001.pdf>.

---

**Pin Assignments**

---

(1) TO92-3L

**( Bottom View )**

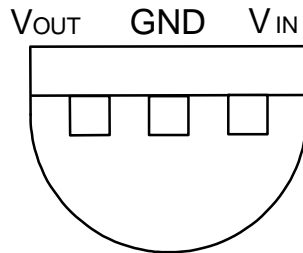

**TO92-3L**

(2) SOP-8L

**(Top View)**

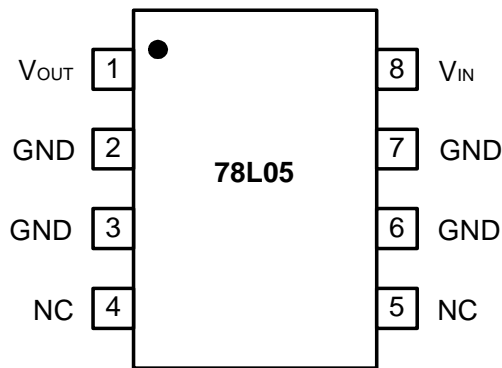

**SOP-8L**

(3) SOT89-3L

**( Top View )**

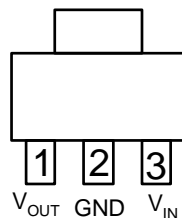

**SOT89-3L**

---

**Pin Descriptions**

---

Name	Description
V <sub>IN</sub>	Operating Voltage Input
V <sub>OUT</sub>	Voltage Output Pin
GND	Ground
NC	No Connection

---

**Absolute Maximum Ratings**

---

Symbol	Parameter	Rating	Unit
ESD HBM	Human Body Model ESD Protection	3	KV
ESD MM	Machine Model ESD Protection	250	V
V <sub>CC</sub>	Supply Voltage	+30	V
V <sub>OUT</sub>	Output Voltage to Ground	5	V
T <sub>ST</sub>	Storage Temperature	-65 to +150	°C
T <sub>OP</sub>	Operating Junction Temperature	-20 to 125	°C
T <sub>MJ</sub>	Maximum Junction Temperature	150	°C

---

**Recommended Operating Conditions**

---

Symbol	Parameter	Min	Max	Unit
V <sub>IN</sub>	Input Voltage	7	20	V
I <sub>OUT</sub>	Output Current	0	100	mA
T <sub>A</sub>	Operating Ambient Temperature	0	85	°C

### Electrical Characteristics (All Output Voltage Versions)

Limits in standard typeface are for  $T_A=25^\circ\text{C}$ , **Bold typeface applies over  $T_J = -20^\circ\text{C}$  to  $125^\circ\text{C}$  for TO92-3L, SOT89-3L and SOP-8L Packages.** Unless otherwise specified:  $V_{IN}=10\text{V}$ ,  $I_O=40\text{mA}$ ,  $C_I=0.33\mu\text{F}$ ,  $C_O=0.1\mu\text{F}$ .

Symbol	Parameter	Conditions	Min.	Typ.	Max.	Unit
$V_O$	Output Voltage		4.8	5	5.2	V
		$7\text{V} \leq V_{IN} \leq 20\text{V}$ $1\text{mA} \leq I_O \leq 40\text{mA}$	<b>4.75</b>		<b>5.25</b>	
		$1\text{mA} \leq I_O \leq 70\text{mA}$	<b>4.75</b>		<b>5.25</b>	
$\Delta V_O$	Line Regulation	$7\text{V} \leq V_{IN} \leq 20\text{V}$		18	75	mV
		$8\text{V} \leq V_{IN} \leq 20\text{V}$		10	54	
$\Delta V_O$	Load Regulation	$1\text{mA} \leq I_O \leq 100\text{mA}$		20	60	mV
		$1\text{mA} \leq I_O \leq 40\text{mA}$		5	30	
$I_Q$	Quiescent Current			3	5	mA
$\Delta I_Q$	Quiescent Current Change	$8\text{V} \leq V_{IN} \leq 20\text{V}$			<b>1.0</b>	
		$1\text{mA} \leq I_O \leq 40\text{mA}$			<b>0.1</b>	
$V_n$	Output Noise Voltage	$f=10\text{Hz}$ to $100\text{kHz}$ (Note 5)	-	40		$\mu\text{V}$
$\Delta V_{IN}/\Delta V_{OUT}$	Ripple Rejection	$f=120\text{Hz}$ $8\text{V} \leq V_{IN} \leq 16\text{V}$	47	62		dB
$I_{PK}$	Peak Output Current			140		mA
$\Delta V_O/\Delta T$	Average Output Voltage Tempco	$I_O=5\text{mA}$		-0.65		$\text{mV}/^\circ\text{C}$
$V_{IN}(\text{Min})$	Minimum Value of Input Voltage Required to Maintain Line Regulation			6.7	7	V
$\theta_{JA}$	Thermal Resistance Junction to Ambient	TO92-3L (Note 6)		176		$^\circ\text{C}/\text{W}$
		SOP-8L (Note 7)		153		
		SOT89-3L (Note 8)		145		
$\theta_{JC}$	Thermal Resistance Junction to Case	TO92-3L (Note 6)		33		
		SOP-8L (Note 7)		18		
		SOT89-3L (Note 8)		25		

Notes: 5. Recommend  $0.01\mu\text{F}$  minimum load capacitance at output to suppress high frequency noise.

6. Test conditions for TO92-3L: No heat sink, no air flow.

7. Test conditions for SOP-8L: Device mounted on 2oz copper, minimum recommended pad layout, FR-4 PCB.

8. Test conditions for SOT89-3L: Device mounted on FR-4 substrate PC board, 2oz copper, with minimum recommended pad layout.

**Typical Performance Characteristics**

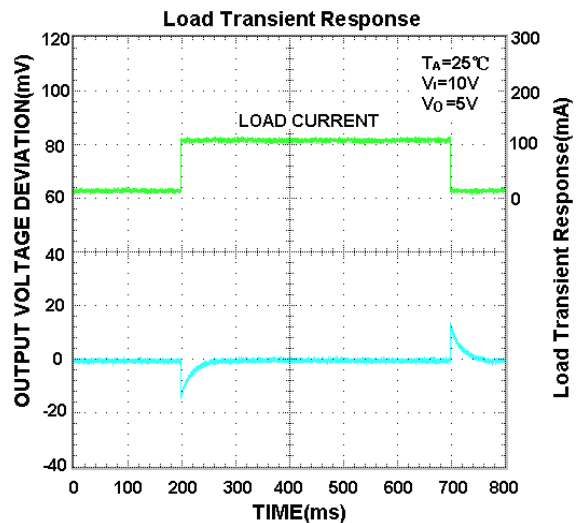
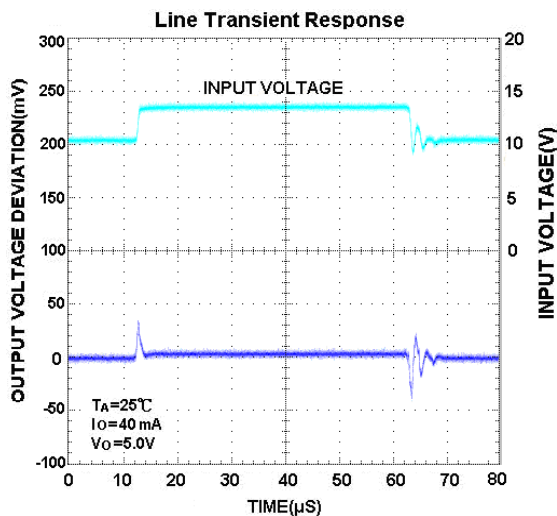
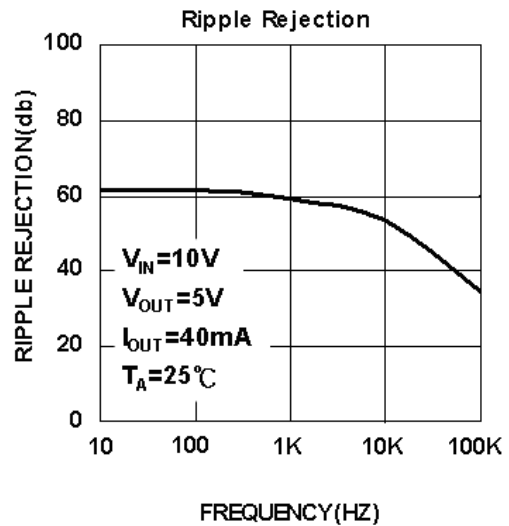
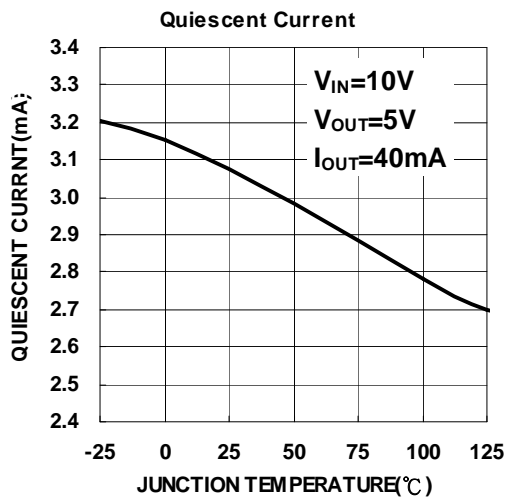
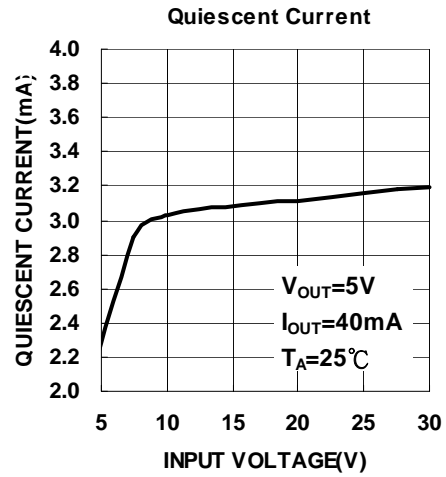
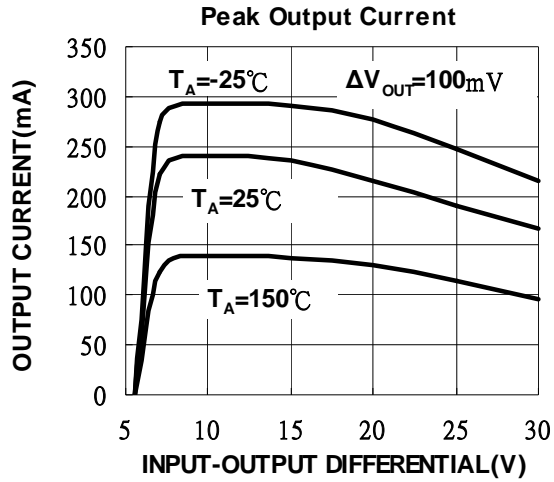

**Typical Performance Characteristics (Continued)**

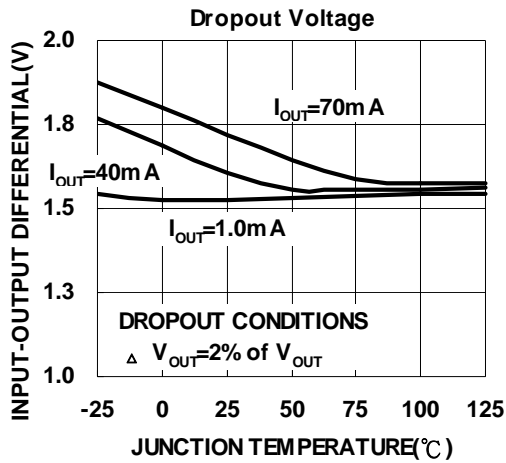

**Typical Application Circuit**

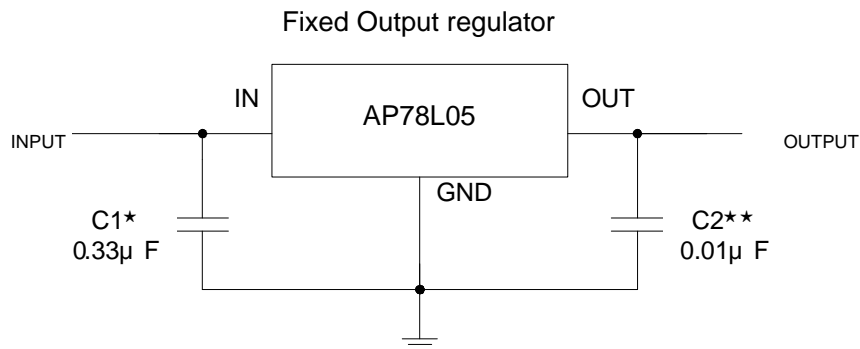

- ★ : Required if the regulator is located more than 3" from the power supply filter.
- ★★ : See (Note 5) in the electrical characteristics table.

**Function Description**

**Introduction**

The AP78L05 fixed-mode 5V output voltage regulator is a three terminal device. The AP78L05 fixed voltage regulator series has built-in thermal overload protection which prevents the device from being damaged due to excessive junction temperature. The regulator also contains internal short-circuit protection which limits the maximum output current, and safe-area protection for the pass transistor which reduces the short-circuit current as the voltage across the pass transistor is increased.

**Marking Information**

(1) TO92-3L

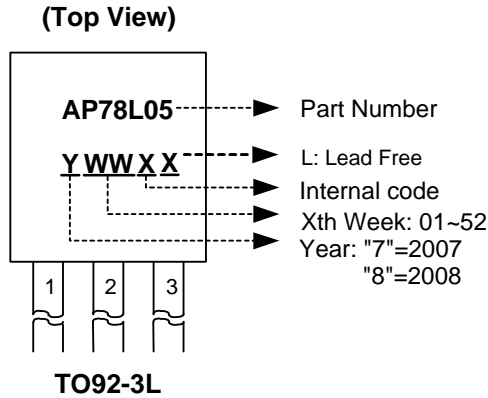

(2) SOP-8L

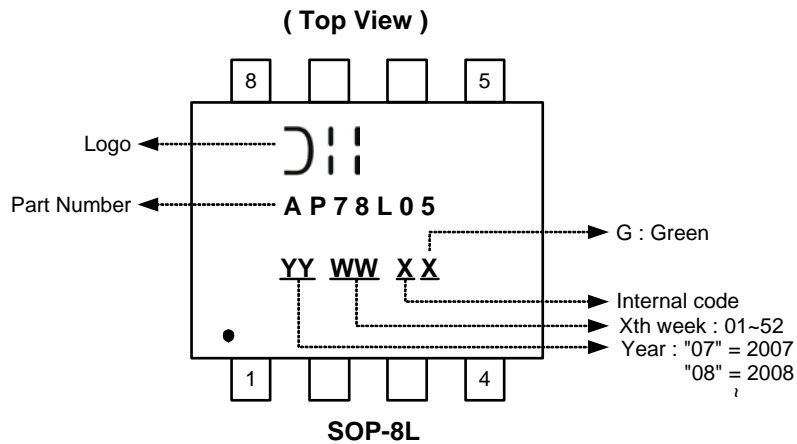

(3) SOT89-3L

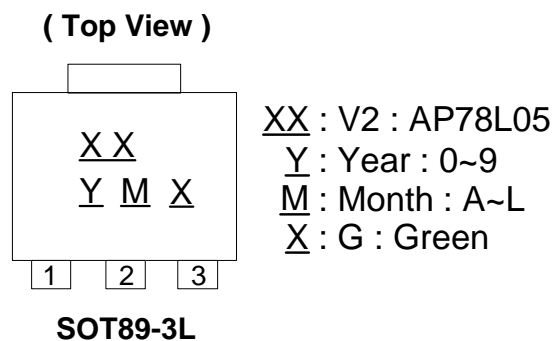

Device	Package	Identification Code
AP78L05	SOT89-3L	V2

**Package Information** (All Dimensions in mm)

(1) Package Type: TO92-3L

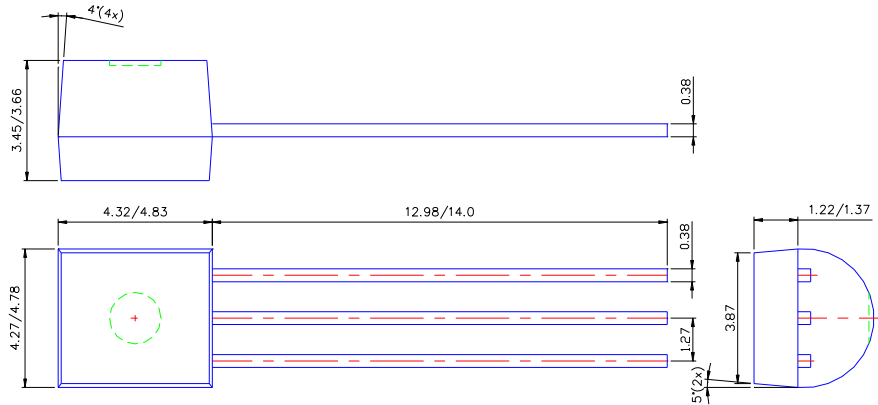

(2) TO92-3L for Ammo pack

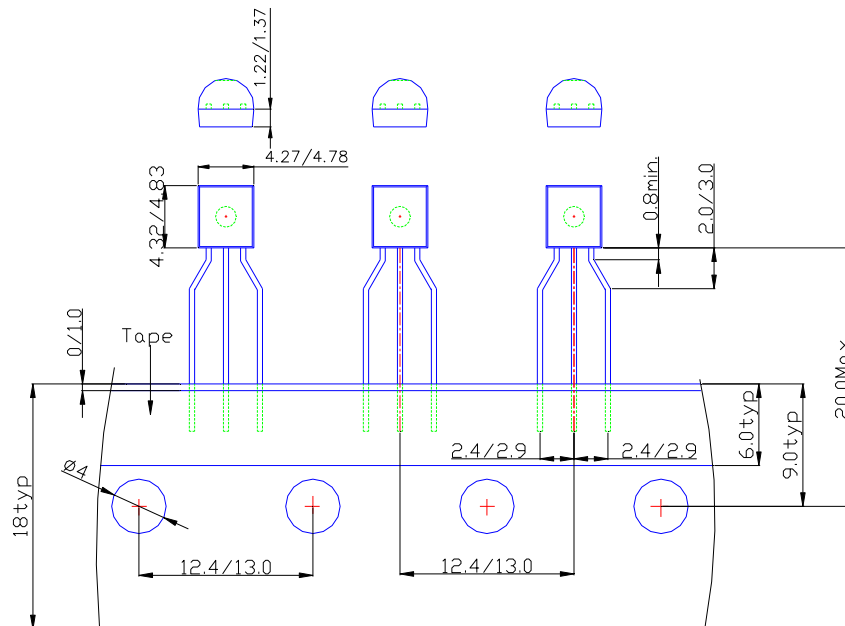

**Package Information (Continued)**

**(3) Package Type: SOP-8L**

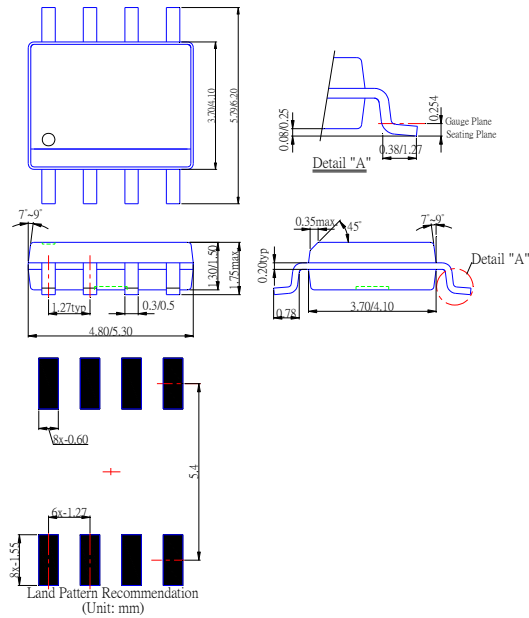

**(4) Package Type: SOT89-3L**

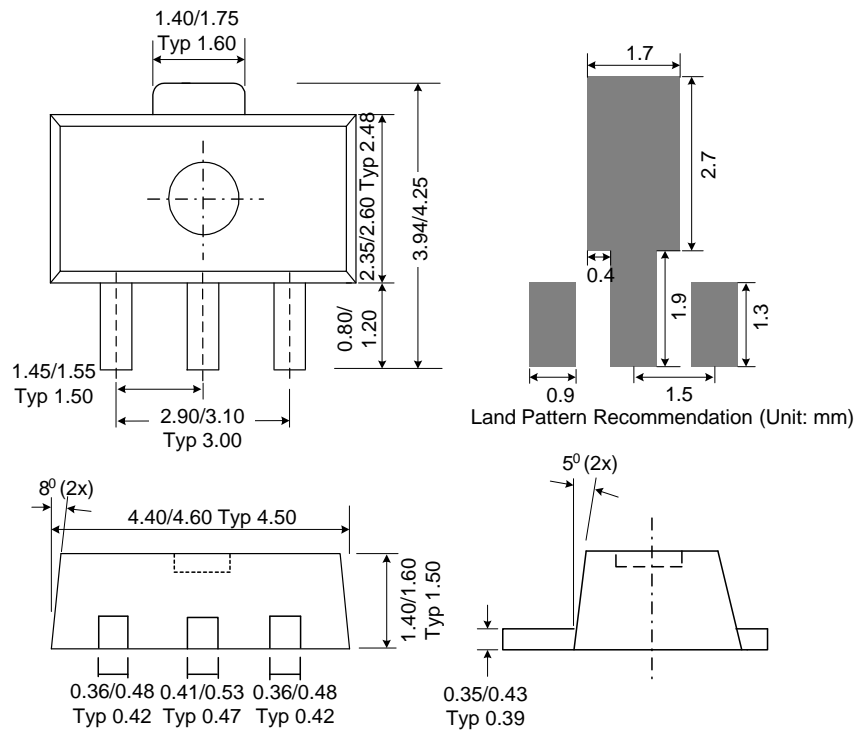

**IMPORTANT NOTICE**

Diodes Incorporated and its subsidiaries reserve the right to make modifications, enhancements, improvements, corrections or other changes without further notice to any product herein. Diodes Incorporated does not assume any liability arising out of the application or use of any product described herein; neither does it convey any license under its patent rights, nor the rights of others. The user of products in such applications shall assume all risks of such use and will agree to hold Diodes Incorporated and all the companies whose products are represented on our website, harmless against all damages.

**LIFE SUPPORT**

Diodes Incorporated products are not authorized for use as critical components in life support devices or systems without the expressed written approval of the President of Diodes Incorporated.

## Looking for pricing, stock, or lifecycle information?

Click below to explore more details on WIN SOURCE:

- ⊖ [View AP78L05SG-13 on WIN SOURCE](#)
- ⊖ [Diodes Incorporated Information](#)

## Optimize Your Supply Chain with WIN SOURCE Solutions

- ✓ Global Sourcing Solution
- ✓ Obsolete Management
- ✓ Cost Control Management
- ✓ Shortage Management
- ✓ Alternative Solution
- ✓ Excess Inventory Management