

SFT1345

Power MOSFET -100V, 275mΩ, -11A, Single P-Channel



ON Semiconductor®

www.onsemi.com

This P-Channel Power MOSFET is produced using ON Semiconductor's trench technology, which is specifically designed to minimize gate charge and low on resistance. This device is suitable for applications with low gate charge driving or low on resistance requirements.

Features

- Low On-Resistance
- 4V drive
- 100% Avalanche Tested
- ESD Diode-Protected Gate
- Pb-Free, Halogen Free and RoHS compliance

Typical Applications

- Reverse Battery Protection
- Load Switch

SPECIFICATIONS

ABSOLUTE MAXIMUM RATING at Ta = 25°C (Note 1, 2)

Parameter	Symbol	Value	Unit
Drain to Source Voltage	V _{DSS}	-100	V
Gate to Source Voltage	V _{GSS}	±20	V
Drain Current (DC)	I _D	-11	A
Drain Current PW ≤ 10μs, duty cycle ≤ 1%	I _{DP}	-44	A
Power Dissipation	P _D	1.0	W
		T _c =25°C 35	W
Junction Temperature	T _j	150	°C
Storage Temperature	T _{stg}	-55 to +150	°C

Note 1 : Stresses exceeding those listed in the Maximum Ratings table may damage the device. If any of these limits are exceeded, device functionality should not be assumed, damage may occur and reliability may be affected.

THERMAL RESISTANCE RATINGS

Parameter	Symbol	Value	Unit
Junction to Case Steady State	R _{θJC}	3.57	°C/W
Junction to Ambient (Note 2)	R _{θJA}	125	

Note 2 : Insertion mounted

V _{DSS}	R _{DS(on)} Max	I _D Max
-100V	275mΩ@ -10V	-11A
	315mΩ@ -4.5V	
	330mΩ@ -4V	

ELECTRICAL CONNECTION P-Channel

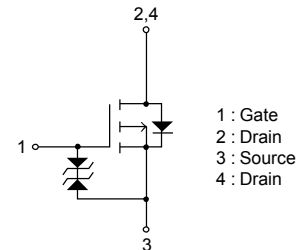

PACKING TYPE : TL

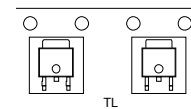

MARKING

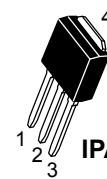
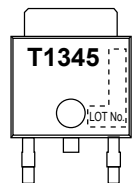

IPAK(TP)

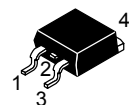

DPAK(TP-FA)

ORDERING INFORMATION

See detailed ordering and shipping information on page 6 of this data sheet.

SFT1345

ELECTRICAL CHARACTERISTICS at Ta = 25°C (Note 3)

Parameter	Symbol	Conditions	Value			Unit
			min	typ	max	
Drain to Source Breakdown Voltage	V(BR)DSS	I _D =-1mA, V _{GS} =0V	-100			V
Zero-Gate Voltage Drain Current	I _{DSS}	V _{DS} =-100V, V _{GS} =0V			-1	μA
Gate to Source Leakage Current	I _{GSS}	V _{GS} =±16V, V _{DS} =0V			±10	μA
Gate Threshold Voltage	V _{GS(th)}	V _{DS} =-10V, I _D =-1mA	-1.2		-2.6	V
Forward Transconductance	g _{FS}	V _{DS} =-10V, I _D =-5.5A		8.5		S
Static Drain to Source On-State Resistance	R _{DS(on)1}	I _D =-5.5A, V _{GS} =-10V		210	275	mΩ
	R _{DS(on)2}	I _D =-3A, V _{GS} =-4.5V		225	315	mΩ
	R _{DS(on)3}	I _D =-3A, V _{GS} =-4V		235	330	mΩ
Input Capacitance	C _{iss}	V _{DS} =-20V, f=1MHz		1020		pF
Output Capacitance	C _{oss}			72		pF
Reverse Transfer Capacitance	C _{rss}			43		pF
Turn-ON Delay Time	t _{d(on)}		See specified Test Circuit		9.5	
Rise Time	t _r			25		ns
Turn-OFF Delay Time	t _{d(off)}			105		ns
Fall Time	t _f			55		ns
Total Gate Charge	Q _g	V _{DS} =-50V, V _{GS} =-10V, I _D =-11A			21	
Gate to Source Charge	Q _{gs}			3.6		nC
Gate to Drain "Miller" Charge	Q _{gd}			4.5		nC
Forward Diode Voltage	V _S D	I _S =-11A, V _{GS} =0V		-0.93	-1.5	V

Note 3 : Product parametric performance is indicated in the Electrical Characteristics for the listed test conditions, unless otherwise noted. Product performance may not be indicated by the Electrical Characteristics if operated under different conditions.

Switching Time Test Circuit

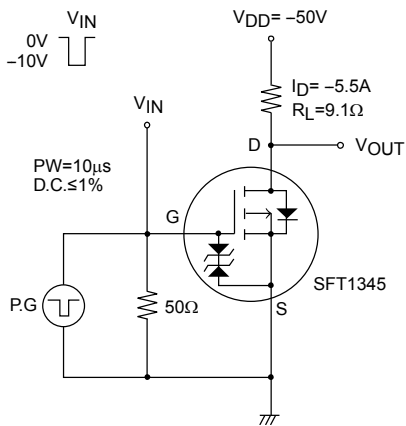

SFT1345

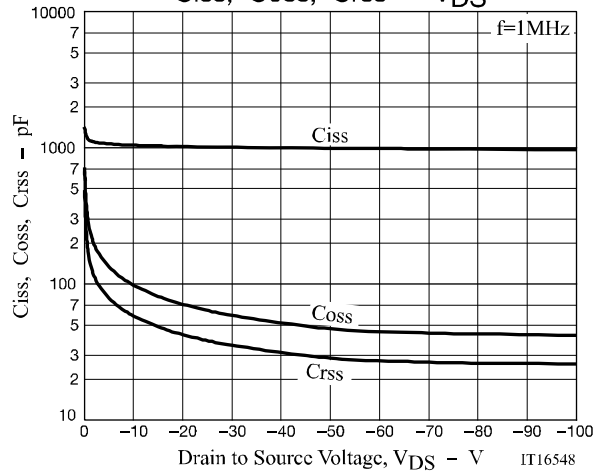
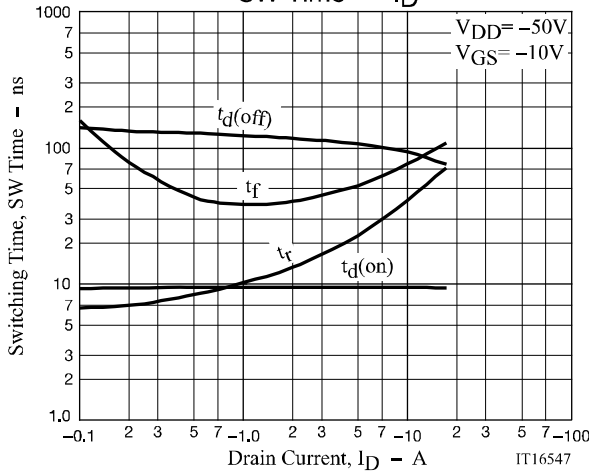
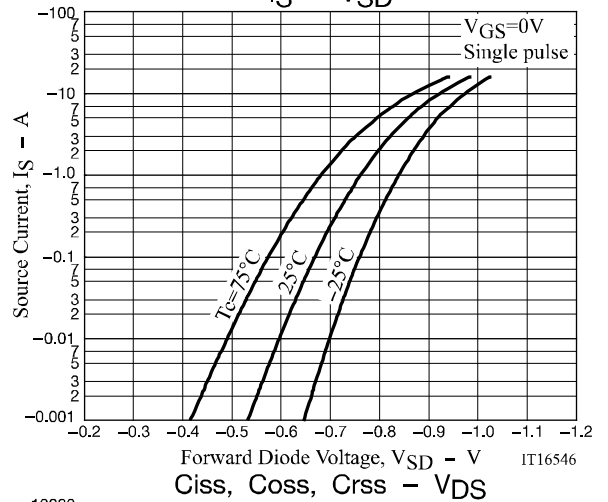
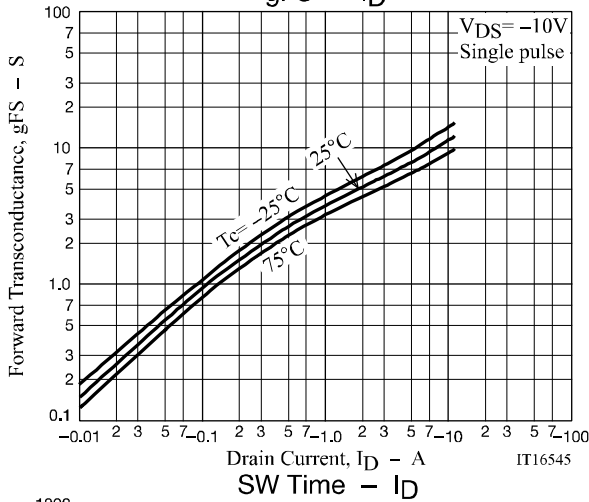
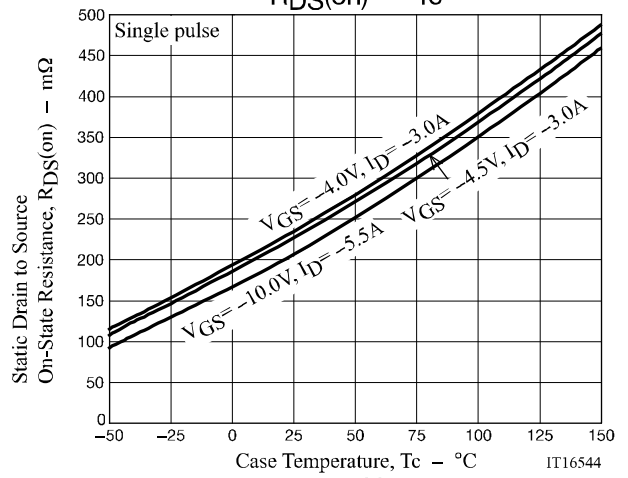
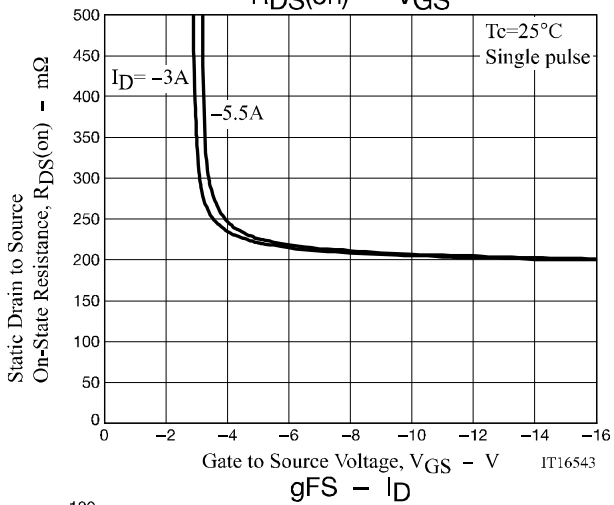
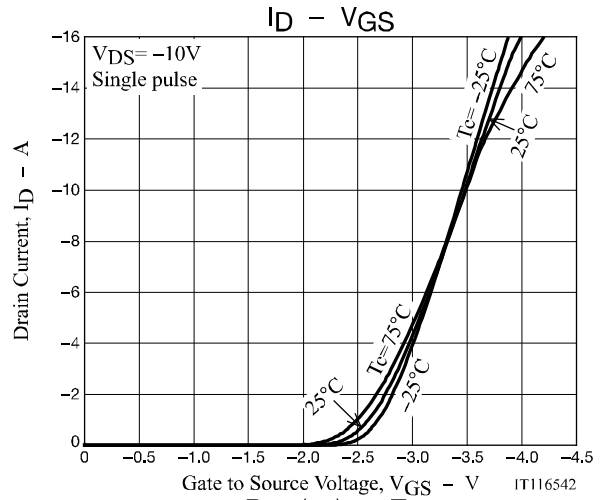
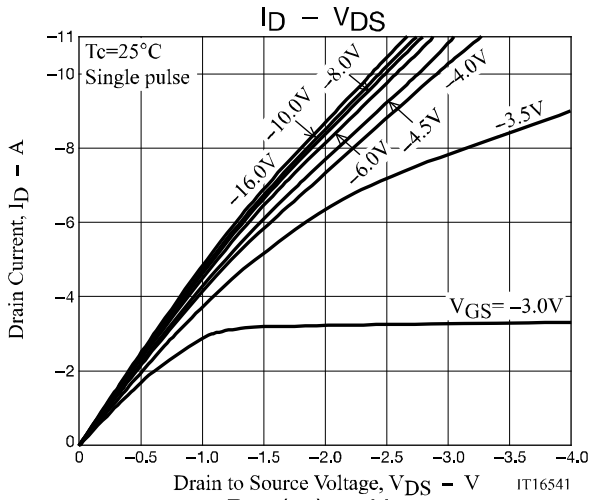

SFT1345

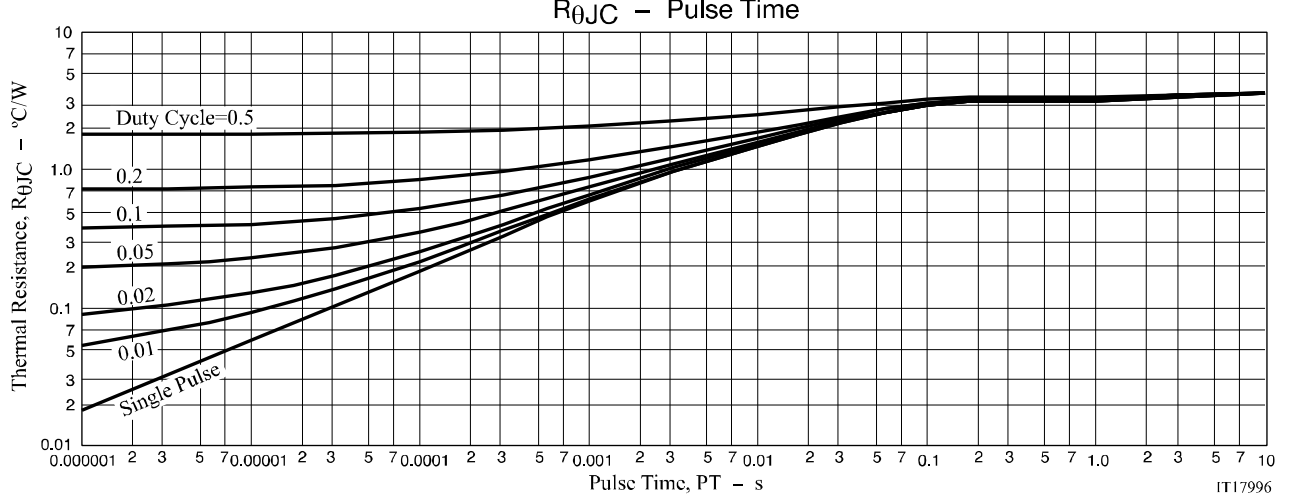
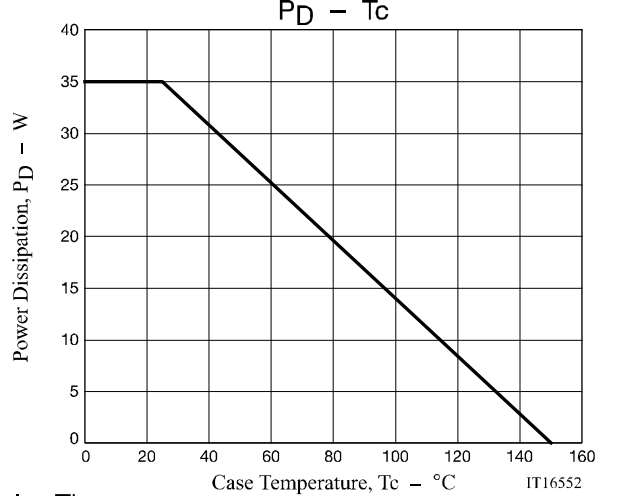
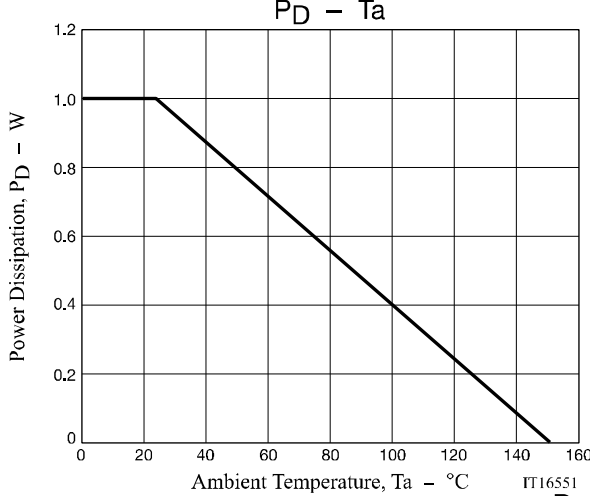
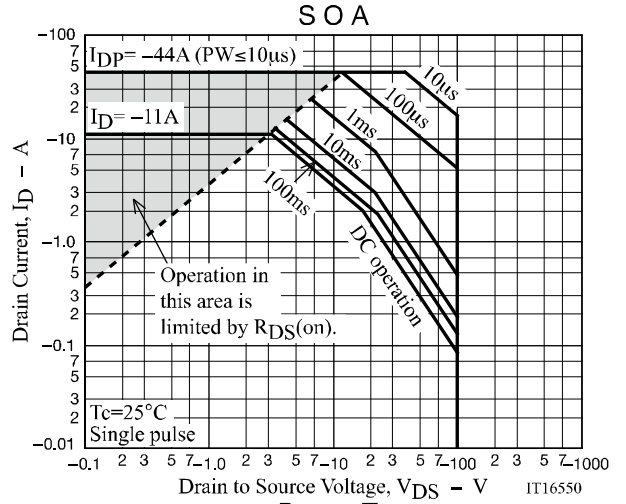
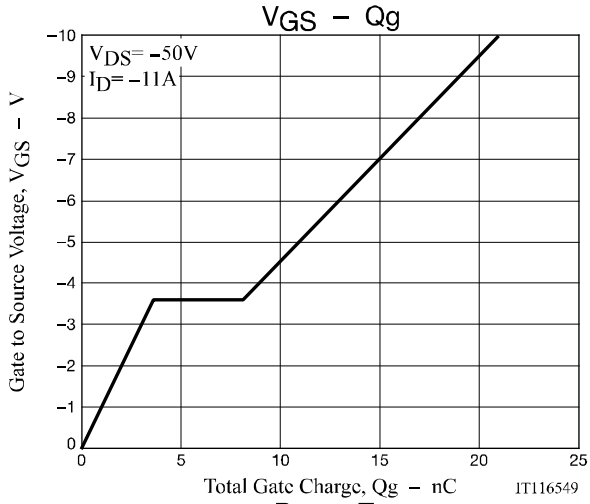

SFT1345

PACKAGE DIMENSIONS

unit : mm

DPAK / TP-FA

CASE 369AH

ISSUE 0

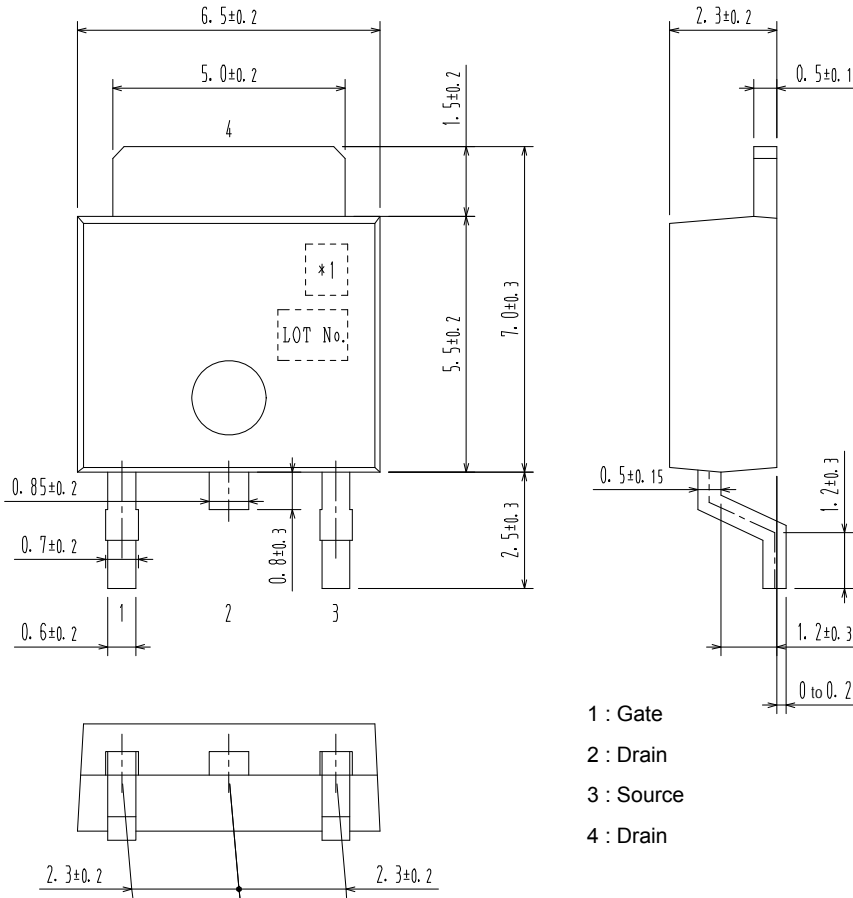

- 1 : Gate
- 2 : Drain
- 3 : Source
- 4 : Drain

Pin 2 is idle pin with electrical designation only carried.

*1: Lot indication

Recommended Soldering Footprint

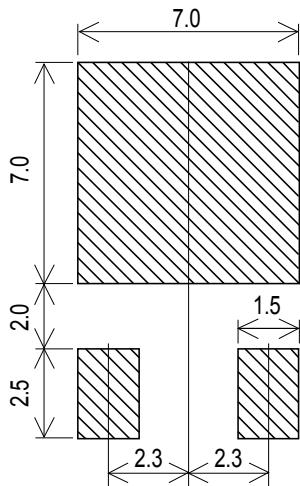

SFT1345

PACKAGE DIMENSIONS

unit : mm

IPAK / TP
CASE 369AJ
ISSUE O

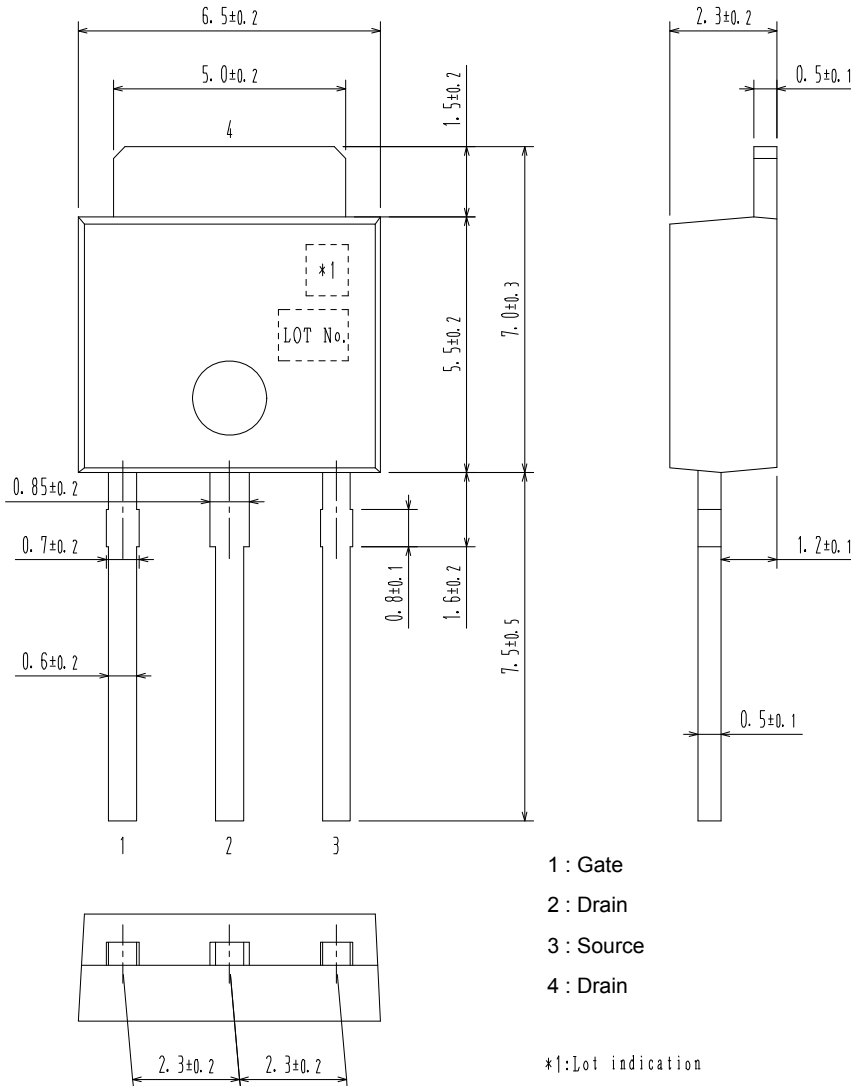

ORDERING INFORMATION

Device	Marking	Package	Shipping (Qty / Packing)
SFT1345-H	T1345	IPAK / TP (Pb-Free / Halogen Free)	500 / Bag
SFT1345-TL-H	T1345	DPAK / TP-FA (Pb-Free / Halogen Free)	700 / Tape & Reel

† For information on tape and reel specifications, including part orientation and tape sizes, please refer to our Tape and Reel Packaging Specifications Brochure, BRD8011/D. http://www.onsemi.com/pub_link/Collateral/BRD8011-D.PDF

Note on usage : Since the SFT1345 is a MOSFET product, please avoid using this device in the vicinity of highly charged objects.

ON Semiconductor and the ON logo are registered trademarks of Semiconductor Components Industries, LLC (SCILLC) or its subsidiaries in the United States and/or other countries. SCILLC owns the rights to a number of patents, trademarks, copyrights, trade secrets, and other intellectual property. A listing of SCILLC's product/patent coverage may be accessed at www.onsemi.com/site/pdf/Patent-Marking.pdf. SCILLC reserves the right to make changes without further notice to any products herein. SCILLC makes no warranty, representation or guarantee regarding the suitability of its products for any particular purpose, nor does SCILLC assume any liability arising out of the application or use of any product or circuit, and specifically disclaims any and all liability, including without limitation special, consequential or incidental damages. "Typical" parameters which may be provided in SCILLC data sheets and/or specifications can and do vary in different applications and actual performance may vary over time. All operating parameters, including "Typicals" must be validated for each customer application by customer's technical experts. SCILLC does not convey any license under its patent rights nor the rights of others. SCILLC products are not designed, intended, or authorized for use as components in systems intended for surgical implant into the body, or other applications intended to support or sustain life, or for any other application in which the failure of the SCILLC product could create a situation where personal injury or death may occur. Should Buyer purchase or use SCILLC products for any such unintended or unauthorized application, Buyer shall indemnify and hold SCILLC and its officers, employees, subsidiaries, affiliates, and distributors harmless against all claims, costs, damages, and expenses, and reasonable attorney fees arising out of, directly or indirectly, any claim of personal injury or death associated with such unintended or unauthorized use, even if such claim alleges that SCILLC was negligent regarding the design or manufacture of the part. SCILLC is an Equal Opportunity/Affirmative Action Employer. This literature is subject to all applicable copyright laws and is not for resale in any manner.

Looking for pricing, stock, or lifecycle information?

Click below to explore more details on WIN SOURCE:

- ⊖ [View SFT1345-TL-H on WIN SOURCE](#)
- ⊖ [ON Semiconductor](#) Information

Optimize Your Supply Chain with WIN SOURCE Solutions

- ✓ Global Sourcing Solution
- ✓ Obsolete Management
- ✓ Cost Control Management
- ✓ Shortage Management
- ✓ Alternative Solution
- ✓ Excess Inventory Management