



**THE DATASHEET OF  
74ABT543CMTC**



# 74ABT543

## Octal Registered Transceiver with 3-STATE Outputs

### General Description

The ABT543 octal transceiver contains two sets of D-type latches for temporary storage of data flowing in either direction. Separate Latch Enable and Output Enable inputs are provided for each register to permit independent control of inputting and outputting in either direction of data flow.

### Features

- Back-to-back registers for storage
- Bidirectional data path
- A and B outputs have current sourcing capability of 32 mA and current sinking capability of 64 mA

- Separate controls for data flow in each direction
- Guaranteed output skew
- Guaranteed multiple output switching specifications
- Output switching specified for both 50 pF and 250 pF loads
- Guaranteed simultaneous switching noise level and dynamic threshold performance
- Guaranteed latchup protection
- High impedance glitch free bus loading during entire power up and power down cycle
- Nondestructive hot insertion capability

### Ordering Code:

Order Number	Package Number	Package Description
74ABT543CSC	M24B	24-Lead Small Outline Integrated Circuit (SOIC), JEDEC MS-013, 0.300" Wide Body
74ABT543CMSA	MSA24	24-Lead Shrink Small Outline Package (SSOP), EIAJ TYPE II, 5.3mm Wide
74ABT543CMTC	MTC24	24-Lead Thin Shrink Small Outline Package (TSSOP), JEDEC MO-153, 4.4mm Wide

Device also available in Tape and Reel. Specify by appending suffix letter "X" to the ordering code.

### Connection Diagram

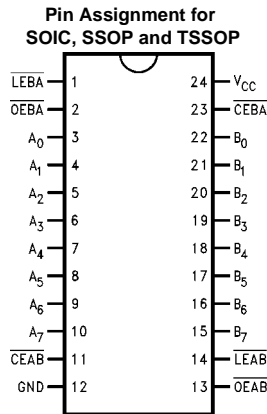

### Pin Descriptions

Pin Names	Description
OEAB, OEBA	Output Enable Inputs
LEAB, LEBA	Latch Enable Inputs
CEAB, CEBA	Chip Enable Inputs
A <sub>0</sub> -A <sub>7</sub>	Side A Inputs or 3-STATE Outputs
B <sub>0</sub> -B <sub>7</sub>	Side B Inputs or 3-STATE Outputs

74ABT543 Octal Registered Transceiver with 3-STATE Outputs

### Functional Description

The ABT543 contains two sets of D-type latches, with separate input and output controls for each. For data flow from A to B, for example, the A to B Enable ( $\overline{CEAB}$ ) input must be low in order to enter data from the A Port or take data from the B Port as indicated in the Data I/O Control Table. With  $\overline{CEAB}$  low, a low signal on ( $\overline{LEAB}$ ) input makes the A to B latches transparent; a subsequent low to high transition of the  $\overline{LEAB}$  line puts the A latches in the storage mode and their outputs no longer change with the A inputs. With  $\overline{CEAB}$  and  $\overline{OEAB}$  both low, the B output buffers are active and reflect the data present on the output of the A latches. Control of data flow from B to A is similar, but using the  $\overline{CEBA}$ ,  $\overline{LEBA}$  and  $\overline{OEBA}$ .

### Data I/O Control Table

Inputs			Latch Status	Output Buffers
$\overline{CEAB}$	$\overline{LEAB}$	$\overline{OEAB}$		
H	X	X	Latched	HIGH Z
X	H	X	Latched	—
L	L	X	Transparent	—
X	X	H	—	HIGH Z
L	X	L	—	Driving

H = HIGH Voltage Level  
 L = LOW Voltage Level  
 X = Immaterial

### Logic Diagram

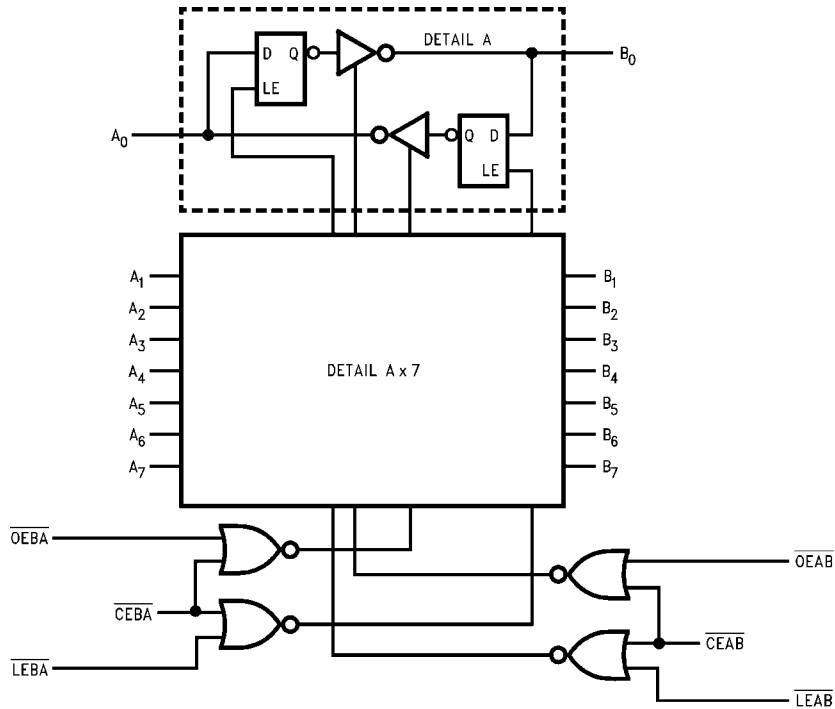

Absolute Maximum Ratings (Note 1)		DC Latchup Source Current	-500 mA
Storage Temperature	-65°C to +150°C	Over Voltage Latchup (I/O)	10V
Ambient Temperature under Bias	-55°C to +125°C	<b>Recommended Operating Conditions</b>	
Junction Temperature under Bias	-55°C to +150°C	Free Air Ambient Temperature	-40°C to +85°C
V <sub>CC</sub> Pin Potential to Ground Pin	-0.5V to +7.0V	Supply Voltage	+4.5V to +5.5V
Input Voltage (Note 2)	-0.5V to +7.0V	Minimum Input Edge Rate ( $\Delta V/\Delta t$ )	
Input Current (Note 2)	-30 mA to +5.0 mA	Data Input	50 mV/ns
Voltage Applied to Any Output in the Disable or Power-Off State	-0.5V to +5.5V	Enable Input	20 mV/ns
Voltage Applied to Any Output in the HIGH State	-0.5V to V <sub>CC</sub>	Clock Input	100 mV/ns
Current Applied to Output in LOW State (Max)	twice the rated I <sub>OL</sub> (mA)	<b>Note 1:</b> Absolute maximum ratings are values beyond which the device may be damaged or have its useful life impaired. Functional operation under these conditions is not implied. <b>Note 2:</b> Either voltage limit or current limit is sufficient to protect inputs.	

## DC Electrical Characteristics

Symbol	Parameter	Min	Typ	Max	Units	V <sub>CC</sub>	Conditions
V <sub>IH</sub>	Input HIGH Voltage	2.0			V		Recognized HIGH Signal
V <sub>IL</sub>	Input LOW Voltage	0.8			V		Recognized LOW Signal
V <sub>CD</sub>	Input Clamp Diode Voltage			-1.2	V		I <sub>IN</sub> = -18 mA (Non I/O Pins)
V <sub>OH</sub>	Output HIGH Voltage	2.5					I <sub>OH</sub> = -3 mA, (A <sub>n</sub> , B <sub>n</sub> ) I <sub>OH</sub> = -32 mA, (A <sub>n</sub> , B <sub>n</sub> )
V <sub>OL</sub>	Output LOW Voltage			0.55	V	Min	I <sub>OL</sub> = 64 mA, (A <sub>n</sub> , B <sub>n</sub> )
V <sub>ID</sub>	Input Leakage Test	4.75			V	0.0	I <sub>ID</sub> = 1.9 $\mu$ A, (Non-I/O Pins) All Other Pins Grounded
I <sub>IH</sub>	Input HIGH Current			1	$\mu$ A	Max	V <sub>IN</sub> = 2.7V (Non-I/O Pins) (Note 3) V <sub>IN</sub> = V <sub>CC</sub> (Non-I/O Pins)
I <sub>BV1</sub>	Input HIGH Current Breakdown Test			7	$\mu$ A	Max	V <sub>IN</sub> = 7.0V (Non-I/O Pins)
I <sub>BVIT</sub>	Input HIGH Current Breakdown Test (I/O)			100	$\mu$ A	Max	V <sub>IN</sub> = 5.5V (A <sub>n</sub> , B <sub>n</sub> )
I <sub>IL</sub>	Input LOW Current			-1	$\mu$ A	Max	V <sub>IN</sub> = 0.5V (Non-I/O Pins) (Note 3) V <sub>IN</sub> = 0.0V (Non-I/O Pins)
I <sub>IH</sub> + I <sub>OZH</sub>	Output Leakage Current			10	$\mu$ A	0V-5.5V	V <sub>OUT</sub> = 2.7V (A <sub>n</sub> , B <sub>n</sub> ); $\overline{OEAB}$ or $\overline{CEAB}$ = 2V
I <sub>IL</sub> + I <sub>OZL</sub>	Output Leakage Current			-10	$\mu$ A	0V-5.5V	V <sub>OUT</sub> = 0.5V (A <sub>n</sub> , B <sub>n</sub> ); $\overline{OEAB}$ or $\overline{CEAB}$ = 2V
I <sub>OS</sub>	Output Short-Circuit Current	-100		-275	mA	Max	V <sub>OUT</sub> = 0V (A <sub>n</sub> , B <sub>n</sub> )
I <sub>CEx</sub>	Output HIGH Leakage Current			50	$\mu$ A	Max	V <sub>OUT</sub> = V <sub>CC</sub> (A <sub>n</sub> , B <sub>n</sub> )
I <sub>ZZ</sub>	Bus Drainage Test			100	$\mu$ A	0.0V	V <sub>OUT</sub> = 5.5V (A <sub>n</sub> , B <sub>n</sub> ); All Others GND
I <sub>CC LH</sub>	Power Supply Current			50	$\mu$ A	Max	All Outputs HIGH
I <sub>CC L</sub>	Power Supply Current			30	mA	Max	All Outputs LOW
I <sub>CC Z</sub>	Power Supply Current			50	$\mu$ A	Max	Outputs 3-STATE All Others at V <sub>CC</sub> or GND
I <sub>CC T</sub>	Additional I <sub>CC</sub> /Input			2.5	mA	Max	V <sub>I</sub> = V <sub>CC</sub> - 2.1V All Others at V <sub>CC</sub> or GND
I <sub>CC D</sub>	Dynamic I <sub>CC</sub> (Note 5)			0.18	mA/MHz	Max	Outputs Open, $\overline{CEAB}$ and $\overline{OEAB}$ = GND, $\overline{CEBA}$ = V <sub>CC</sub> , One Bit Toggling, 50% Duty Cycle, (Note 4)

**Note 3:** Guaranteed but not tested.

**Note 4:** For 8-bit toggling. I<sub>CCD</sub> < 1.4 mA/MHz.

**Note 5:** Guaranteed, but not tested.

DC Electrical Characteristics							
(SOIC Package)							
Symbol	Parameter	Min	Typ	Max	Units	V <sub>CC</sub>	Conditions C <sub>L</sub> = 50 pF, R <sub>L</sub> = 500Ω
V <sub>OLP</sub>	Quiet Output Maximum Dynamic V <sub>OL</sub>		0.7	1.0	V	5.0	T <sub>A</sub> = 25°C (Note 6)
V <sub>OLV</sub>	Quiet Output Minimum Dynamic V <sub>OL</sub>	-1.2	-0.8		V	5.0	T <sub>A</sub> = 25°C (Note 6)
V <sub>OHV</sub>	Minimum HIGH Level Dynamic Output Voltage	2.5	3.0		V	5.0	T <sub>A</sub> = 25°C (Note 7)
V <sub>IHD</sub>	Minimum HIGH Level Dynamic Input Voltage	2.0	1.7		V	5.0	T <sub>A</sub> = 25°C (Note 8)
V <sub>ILD</sub>	Maximum LOW Level Dynamic Input Voltage		0.7	0.9	V	5.0	T <sub>A</sub> = 25°C (Note 8)
<p><b>Note 6:</b> Max number of outputs defined as (n). n – 1 data inputs are driven 0V to 3V. One output at LOW. Guaranteed, but not tested.</p> <p><b>Note 7:</b> Max number of outputs defined as (n). n–1 data inputs are driven 0V to 3V. One output HIGH. Guaranteed, but not tested.</p> <p><b>Note 8:</b> Max number of data inputs (n) switching. n – 1 inputs switching 0V to 3V. Input-under-test switching: 3V to threshold (V<sub>ILD</sub>), 0V to threshold (V<sub>IHD</sub>). Guaranteed, but not tested.</p>							
AC Electrical Characteristics							
(SOIC and SSOP Packages)							
Symbol	Parameter	T <sub>A</sub> = +25°C V <sub>CC</sub> = +5.0V C <sub>L</sub> = 50 pF			T <sub>A</sub> = -40°C to +85°C V <sub>CC</sub> = 4.5V–5.5V C <sub>L</sub> = 50 pF		Units
		Min	Typ	Max	Min	Max	
t <sub>PLH</sub>	Propagation Delay A <sub>n</sub> to B <sub>n</sub> or B <sub>n</sub> to A <sub>n</sub>	1.5	3.1	4.8	1.5	4.8	ns
t <sub>PHL</sub>	Propagation Delay $\overline{LEAB}$ to B <sub>n</sub> , $\overline{LEBA}$ to A <sub>n</sub> $\overline{OEBA}$ or $\overline{OEAB}$ to A <sub>n</sub> or B <sub>n</sub>	1.5		4.8	1.5	4.8	
t <sub>PLH</sub>	Propagation Delay						
t <sub>PHL</sub>	Propagation Delay	1.6	3.4	5.3	1.6	5.3	ns
t <sub>PZH</sub>	Enable Time						
t <sub>PZL</sub>	Enable Time	1.5	3.6	5.8	1.5	5.8	ns
t <sub>PHZ</sub>	Disable Time						
t <sub>PLZ</sub>	Disable Time	2.0	4.0	6.5	2.0	6.5	ns
t <sub>PHZ</sub>	Disable Time	2.0		6.5	2.0	6.5	
t <sub>PLZ</sub>	Disable Time	2.0		6.5	2.0	6.5	
t <sub>PHZ</sub>	Disable Time	2.0		6.5	2.0	6.5	
t <sub>PLZ</sub>	Disable Time	2.0		6.5	2.0	6.5	
t <sub>PHZ</sub>	Disable Time	2.0		6.5	2.0	6.5	
t <sub>PLZ</sub>	Disable Time	2.0		6.5	2.0	6.5	
t <sub>PHZ</sub>	Disable Time	2.0		6.5	2.0	6.5	
t <sub>PLZ</sub>	Disable Time	2.0		6.5	2.0	6.5	
t <sub>PHZ</sub>	Disable Time	2.0		6.5	2.0	6.5	
t <sub>PLZ</sub>	Disable Time	2.0		6.5	2.0	6.5	
t <sub>PHZ</sub>	Disable Time	2.0		6.5	2.0	6.5	
t <sub>PLZ</sub>	Disable Time	2.0		6.5	2.0	6.5	
t <sub>PHZ</sub>	Disable Time	2.0		6.5	2.0	6.5	
t <sub>PLZ</sub>	Disable Time	2.0		6.5	2.0	6.5	
t <sub>PHZ</sub>	Disable Time	2.0		6.5	2.0	6.5	
t <sub>PLZ</sub>	Disable Time	2.0		6.5	2.0	6.5	
t <sub>PHZ</sub>	Disable Time	2.0		6.5	2.0	6.5	
t <sub>PLZ</sub>	Disable Time	2.0		6.5	2.0	6.5	
t <sub>PHZ</sub>	Disable Time	2.0		6.5	2.0	6.5	
t <sub>PLZ</sub>	Disable Time	2.0		6.5	2.0	6.5	
t <sub>PHZ</sub>	Disable Time	2.0		6.5	2.0	6.5	
t <sub>PLZ</sub>	Disable Time	2.0		6.5	2.0	6.5	
t <sub>PHZ</sub>	Disable Time	2.0		6.5	2.0	6.5	
t <sub>PLZ</sub>	Disable Time	2.0		6.5	2.0	6.5	
t <sub>PHZ</sub>	Disable Time	2.0		6.5	2.0	6.5	
t <sub>PLZ</sub>	Disable Time	2.0		6.5	2.0	6.5	
t <sub>PHZ</sub>	Disable Time	2.0		6.5	2.0	6.5	
t <sub>PLZ</sub>	Disable Time	2.0		6.5	2.0	6.5	
t <sub>PHZ</sub>	Disable Time	2.0		6.5	2.0	6.5	
t <sub>PLZ</sub>	Disable Time	2.0		6.5	2.0	6.5	
t <sub>PHZ</sub>	Disable Time	2.0		6.5	2.0	6.5	
t <sub>PLZ</sub>	Disable Time	2.0		6.5	2.0	6.5	
t <sub>PHZ</sub>	Disable Time	2.0		6.5	2.0	6.5	
t <sub>PLZ</sub>	Disable Time	2.0		6.5	2.0	6.5	
t <sub>PHZ</sub>	Disable Time	2.0		6.5	2.0	6.5	
t <sub>PLZ</sub>	Disable Time	2.0		6.5	2.0	6.5	
t <sub>PHZ</sub>	Disable Time	2.0		6.5	2.0	6.5	
t <sub>PLZ</sub>	Disable Time	2.0		6.5	2.0	6.5	
t <sub>PHZ</sub>	Disable Time	2.0		6.5	2.0	6.5	
t <sub>PLZ</sub>	Disable Time	2.0		6.5	2.0	6.5	
t <sub>PHZ</sub>	Disable Time	2.0		6.5	2.0	6.5	
t <sub>PLZ</sub>	Disable Time	2.0		6.5	2.0	6.5	
t <sub>PHZ</sub>	Disable Time	2.0		6.5	2.0	6.5	
t <sub>PLZ</sub>	Disable Time	2.0		6.5	2.0	6.5	
t <sub>PHZ</sub>	Disable Time	2.0		6.5	2.0	6.5	
t <sub>PLZ</sub>	Disable Time	2.0		6.5	2.0	6.5	
t <sub>PHZ</sub>	Disable Time	2.0		6.5	2.0	6.5	
t <sub>PLZ</sub>	Disable Time	2.0		6.5	2.0	6.5	
t <sub>PHZ</sub>	Disable Time	2.0		6.5	2.0	6.5	
t <sub>PLZ</sub>	Disable Time	2.0		6.5	2.0	6.5	
t <sub>PHZ</sub>	Disable Time	2.0		6.5	2.0	6.5	
t <sub>PLZ</sub>	Disable Time	2.0		6.5	2.0	6.5	
t <sub>PHZ</sub>	Disable Time	2.0		6.5	2.0	6.5	
t <sub>PLZ</sub>	Disable Time	2.0		6.5	2.0	6.5	
t <sub>PHZ</sub>	Disable Time	2.0		6.5	2.0	6.5	
t <sub>PLZ</sub>	Disable Time	2.0		6.5	2.0	6.5	
t <sub>PHZ</sub>	Disable Time	2.0		6.5	2.0	6.5	
t <sub>PLZ</sub>	Disable Time	2.0		6.5	2.0	6.5	
t <sub>PHZ</sub>	Disable Time	2.0		6.5	2.0	6.5	
t <sub>PLZ</sub>	Disable Time	2.0		6.5	2.0	6.5	
t <sub>PHZ</sub>	Disable Time	2.0		6.5	2.0	6.5	
t <sub>PLZ</sub>	Disable Time	2.0		6.5	2.0	6.5	
t <sub>PHZ</sub>	Disable Time	2.0		6.5	2.0	6.5	
t <sub>PLZ</sub>	Disable Time	2.0		6.5	2.0	6.5	
t <sub>PHZ</sub>	Disable Time	2.0		6.5	2.0	6.5	
t <sub>PLZ</sub>	Disable Time	2.0		6.5	2.0	6.5	
t <sub>PHZ</sub>	Disable Time	2.0		6.5	2.0	6.5	
t <sub>PLZ</sub>	Disable Time	2.0		6.5	2.0	6.5	
t <sub>PHZ</sub>	Disable Time	2.0		6.5	2.0	6.5	
t <sub>PLZ</sub>	Disable Time	2.0		6.5	2.0	6.5	
t <sub>PHZ</sub>	Disable Time	2.0		6.5	2.0	6.5	
t <sub>PLZ</sub>	Disable Time	2.0		6.5	2.0	6.5	
t <sub>PHZ</sub>	Disable Time	2.0		6.5	2.0	6.5	
t <sub>PLZ</sub>	Disable Time	2.0		6.5	2.0	6.5	
t <sub>PHZ</sub>	Disable Time	2.0		6.5	2.0	6.5	
t <sub>PLZ</sub>	Disable Time	2.0		6.5	2.0	6.5	
t <sub>PHZ</sub>	Disable Time	2.0		6.5	2.0	6.5	
t <sub>PLZ</sub>	Disable Time	2.0		6.5	2.0	6.5	
t <sub>PHZ</sub>	Disable Time	2.0		6.5	2.0	6.5	
t <sub>PLZ</sub>	Disable Time	2.0		6.5	2.0	6.5	
t <sub>PHZ</sub>	Disable Time	2.0		6.5	2.0	6.5	
t <sub>PLZ</sub>	Disable Time	2.0		6.5	2.0	6.5	
t <sub>PHZ</sub>	Disable Time	2.0		6.5	2.0	6.5	
t <sub>PLZ</sub>	Disable Time	2.0		6.5	2.0	6.5	
t <sub>PHZ</sub>	Disable Time	2.0		6.5	2.0	6.5	
t <sub>PLZ</sub>	Disable Time	2.0		6.5	2.0	6.5	
t <sub>PHZ</sub>	Disable Time	2.0		6.5	2.0	6.5	
t <sub>PLZ</sub>	Disable Time	2.0		6.5	2.0	6.5	
t <sub>PHZ</sub>	Disable Time	2.0		6.5	2.0	6.5	
t <sub>PLZ</sub>	Disable Time	2.0		6.5	2.0	6.5	
t <sub>PHZ</sub>	Disable Time	2.0		6.5	2.0	6.5	
t <sub>PLZ</sub>	Disable Time	2.0		6.5	2.0	6.5	
t <sub>PHZ</sub>	Disable Time	2.0		6.5	2.0	6.5	
t <sub>PLZ</sub>	Disable Time	2.0		6.5	2.0	6.5	
t <sub>PHZ</sub>	Disable Time	2.0		6.5	2.0	6.5	
t <sub>PLZ</sub>	Disable Time	2.0		6.5	2.0	6.5	
t <sub>PHZ</sub>	Disable Time	2.0		6.5	2.0	6.5	
t <sub>PLZ</sub>	Disable Time	2.0		6.5	2.0	6.5	
t <sub>PHZ</sub>	Disable Time	2.0		6.5	2.0	6.5	
t <sub>PLZ</sub>	Disable Time	2.0		6.5	2.0	6.5	
t <sub>PHZ</sub>	Disable Time	2.0		6.5	2.0	6.5	
t <sub>PLZ</sub>	Disable Time	2.0		6.5	2.0	6.5	
t <sub>PHZ</sub>	Disable Time	2.0		6.5	2.0	6.5	
t <sub>PLZ</sub>	Disable Time	2.0		6.5	2.0	6.5	
t <sub>PHZ</sub>	Disable Time	2.0		6.5	2.0	6.5	
t <sub>PLZ</sub>	Disable Time	2.0		6.5	2.0	6.5	
t <sub>PHZ</sub>	Disable Time	2.0		6.5	2.0	6.5	
t <sub>PLZ</sub>	Disable Time	2.0		6.5	2.0	6.5	
t <sub>PHZ</sub>	Disable Time	2.0		6.5	2.0	6.5	
t <sub>PLZ</sub>	Disable Time	2.0		6.5	2.0	6.5	
t <sub>PHZ</sub>	Disable Time	2.0		6.5	2.0	6.5	
t <sub>PLZ</sub>	Disable Time	2.0		6.5	2.0	6.5	
t <sub>PHZ</sub>	Disable Time	2.0		6.5	2.0	6.5	
t <sub>PLZ</sub>	Disable Time	2.0		6.5	2.0	6.5	
t <sub>PHZ</sub>	Disable Time	2.0		6.5	2.0	6.5	
t <sub>PLZ</sub>	Disable Time	2.0		6.5	2.0	6.5	
t <sub>PHZ</sub>	Disable Time	2.0		6.5	2.0	6.5	
t <sub>PLZ</sub>	Disable Time	2.0		6.5	2.0	6.5	
t <sub>PHZ</sub>	Disable Time	2.0		6.5	2.0	6.5	
t <sub>PLZ</sub>	Disable Time	2.0		6.5	2.0	6.5	
t <sub>PHZ</sub>	Disable Time	2.0		6.5	2.0	6.5	
t <sub>PLZ</sub>	Disable Time	2.0		6.5	2.0	6.5	
t <sub>PHZ</sub>	Disable Time	2.0		6.5	2.0	6.5	
t <sub>PLZ</sub>	Disable Time	2.0		6.5	2.0	6.5	
t <sub>PHZ</sub>	Disable Time	2.0		6.5	2.0	6.5	
t <sub>PLZ</sub>	Disable Time	2.0		6.5	2.0	6.5	
t <sub>PHZ</sub>	Disable Time	2.0		6.5	2.0	6.5	
t <sub>PLZ</sub>	Disable Time	2.0		6.5	2.0	6.5	
t <sub>PHZ</sub>	Disable Time	2.0		6.5	2.0	6.5	
t <sub>PLZ</sub>	Disable Time	2.0		6.5	2.0	6.5	
t <sub>PHZ</sub>	Disable Time	2.0		6.5	2.0	6.5	
t <sub>PLZ</sub>	Disable Time	2.0		6.5	2.0	6.5	
t <sub>PHZ</sub>	Disable Time	2.0		6.5	2.0	6.5	
t <sub>PLZ</sub>	Disable Time	2.0		6.5	2.0	6.5	
t <sub>PHZ</sub>	Disable Time	2.0		6.5	2.0	6.5	
t <sub>PLZ</sub>	Disable Time	2.0		6.5	2.0	6.5	
t <sub>PHZ</sub>	Disable Time	2.0		6.5	2.0	6.5	
t <sub>PLZ</sub>	Disable Time	2.0		6.5	2.0	6.5	
t <sub>PHZ</sub>	Disable Time	2.0		6.5	2.0	6.5	
t <sub>PLZ</sub>	Disable Time	2.0		6.5	2.0	6.5	
t <sub>PHZ</sub>	Disable Time	2.0		6.5	2.0	6.5	
t <sub>PLZ</sub>	Disable Time	2.0		6.5	2.0	6.5	
t <sub>PHZ</sub>	Disable Time	2.0		6.5	2.0	6.5	
t <sub>PLZ</sub>							

Extended AC Electrical Characteristics									
(SOIC Package)									
Symbol	Parameter	$T_A = -40^\circ\text{C to } +85^\circ\text{C}$ $V_{CC} = 4.5\text{V} - 5.5\text{V}$ $C_L = 50\text{ pF}$ 8 Outputs Switching (Note 9)			$T_A = -40^\circ\text{C to } +85^\circ\text{C}$ $V_{CC} = 4.5\text{V} - 5.5\text{V}$ $C_L = 250\text{ pF}$ 1 Output Switching (Note 10)		$T_A = -40^\circ\text{C to } +85^\circ\text{C}$ $V_{CC} = 4.5\text{V} - 5.5\text{V}$ $C_L = 250\text{ pF}$ 8 Outputs Switching (Note 11)		Units
		Min	Typ	Max	Min	Max	Min	Max	
$f_{\text{TOGGLE}}$	Max Toggle Frequency	100							MHz
$t_{\text{PLH}}$	Propagation Delay	1.5		6.2	2.0	7.5	2.5	10.0	ns
$t_{\text{PHL}}$	$A_n$ to $B_n$ or $B_n$ to $A_n$	1.5		6.2	2.0	7.5	2.5	10.0	ns
$t_{\text{PLH}}$	Propagation Delay	1.5		6.5	2.0	8.0	2.5	10.5	ns
$t_{\text{PHL}}$	$\overline{\text{LEAB}}$ to $B_n$ , $\overline{\text{LEB}\overline{\text{A}}}$ to $A_n$	1.5		6.5	2.0	8.0	2.5	10.5	ns
$t_{\text{PZH}}$	Output Enable Time								
$t_{\text{PZL}}$	$\overline{\text{OEBA}}$ or $\overline{\text{OEAB}}$ to $A_n$ or $B_n$	1.5		7.5	2.0	8.5	2.5	11.0	ns
$t_{\text{PZL}}$	$\overline{\text{CEBA}}$ or $\overline{\text{CEAB}}$ to $A_n$ or $B_n$	1.5		7.5	2.0	8.5	2.5	11.0	ns
$t_{\text{PHZ}}$	Output Disable Time								
$t_{\text{PLZ}}$	$\overline{\text{OEBA}}$ or $\overline{\text{OEAB}}$ to $A_n$ or $B_n$	1.5		8.5	(Note 12)		(Note 12)		ns
$t_{\text{PLZ}}$	$\overline{\text{CEBA}}$ or $\overline{\text{CEAB}}$ to $A_n$ or $B_n$	1.5		8.5	(Note 12)		(Note 12)		ns
<p><b>Note 9:</b> This specification is guaranteed but not tested. The limits apply to propagation delays for all paths described switching in phase (i.e., all LOW-to-HIGH, HIGH-to-LOW, etc.).</p> <p><b>Note 10:</b> This specification is guaranteed but not tested. The limits represent propagation delay with 250pF load capacitors in place of the 50 pF load capacitors in the standard AC load. This specification pertains to single output switching only.</p> <p><b>Note 11:</b> This specification is guaranteed but not tested. The limits represent propagation delays for all paths described switching in phase (i.e., all LOW-to-HIGH, HIGH-to-LOW, etc.) with 250 pF load capacitors in place of the 50 pF load capacitors in the standard AC load.</p> <p><b>Note 12:</b> The 3-STATE delay times are dominated by the RC network (500Ω, 250 pF) on the output and has been excluded from the datasheet</p>									
Skew									
(SOIC Package)									
Symbol	Parameter	$T_A = -40^\circ\text{C to } +85^\circ\text{C}$ $V_{CC} = 4.5\text{V} - 5.5\text{V}$ $C_L = 50\text{ pF}$ 8 Outputs Switching (Note 13)			$T_A = -40^\circ\text{C to } +85^\circ\text{C}$ $V_{CC} = 4.5\text{V} - 5.5\text{V}$ $C_L = 250\text{ pF}$ 8 Outputs Switching (Note 14)				Units
		Max			Max				
$t_{\text{OSHL}}$ (Note 15)	Pin to Pin Skew HL Transitions	1.0			2.0				ns
$t_{\text{OSLH}}$ (Note 15)	Pin to Pin Skew LH Transitions	1.3			2.0				ns
$t_{\text{PS}}$ (Note 16)	Duty Cycle LH-HL Skew	2.0			4.0				ns
$t_{\text{OST}}$ (Note 15)	Pin to Pin Skew LH/HL Transitions	2.0			4.0				ns
$t_{\text{PV}}$ (Note 17)	Device to Device Skew LH/HL Transitions	2.5			4.5				ns
<p><b>Note 13:</b> This specification is guaranteed but not tested. The limits apply to propagation delays for all paths described switching in phase (i.e., all LOW-to-HIGH, HIGH-to-LOW, etc.).</p> <p><b>Note 14:</b> This specification is guaranteed but not tested. The limits represent propagation delays with 250 pF load capacitors in place of the 50 pF load capacitors in the standard AC load.</p> <p><b>Note 15:</b> Skew is defined as the absolute value of the difference between the actual propagation delays for any two separate outputs of the same device. The specification applies to any outputs switching HIGH-to-LOW (<math>t_{\text{OSHL}}</math>), LOW-to-HIGH (<math>t_{\text{OSLH}}</math>), or any combination switching LOW-to-HIGH and/or HIGH-to-LOW (<math>t_{\text{OST}}</math>). This specification is guaranteed but not tested.</p> <p><b>Note 16:</b> This describes the difference between the delay of the LOW-to-HIGH and the HIGH-to-LOW transition on the same pin. It is measured across all the outputs (drivers) on the same chip, the worst (largest delta) number is the guaranteed specification. This specification is guaranteed but not tested.</p> <p><b>Note 17:</b> Propagation delay variation for a given set of conditions (i.e., temperature and <math>V_{CC}</math>) from device to device. This specification is guaranteed but not tested.</p>									

## Capacitance

Symbol	Parameter	Typ	Units	Conditions: $T_A = 25^\circ\text{C}$
$C_{IN}$	Input Capacitance	5.0	pF	$V_{CC} = 0\text{V}$ (non I/O pins)
$C_{I/O}$ (Note 18)	Output Capacitance	11.0	pF	$V_{CC} = 5.0\text{V}$ ( $A_n, B_n$ )

Note 18:  $C_{I/O}$  is measured at frequency,  $f = 1\text{ MHz}$ , PER MLT-STD-883B, METHOD 3012.

## AC Loading

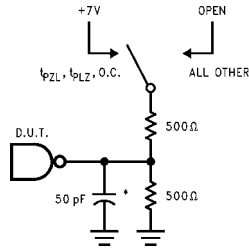

\*Includes jig and probe capacitance

FIGURE 1. Standard AC Test Load

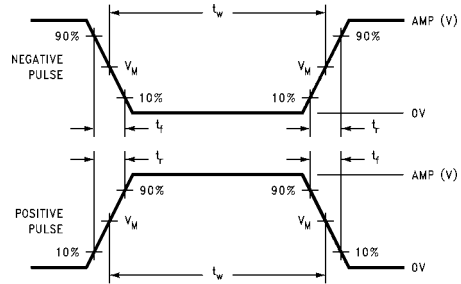

FIGURE 2.  $V_M = 1.5\text{V}$   
Input Pulse Requirements

Amplitude	Rep. Rate	$t_w$	$t_r$	$t_f$
3V	1 MHz	500 ns	2.5 ns	2.5 ns

FIGURE 3. Test Input Signal Requirements

## AC Waveforms

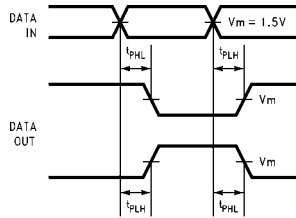

FIGURE 4. Propagation Delay Waveforms for Inverting and Non-Inverting Functions

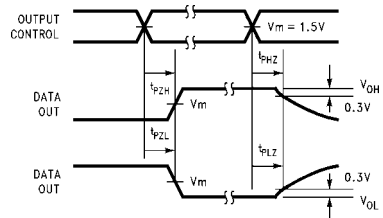

FIGURE 6. 3-STATE Output HIGH and LOW Enable and Disable Times

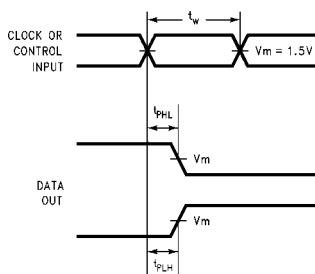

FIGURE 5. Propagation Delay, Pulse Width Waveforms

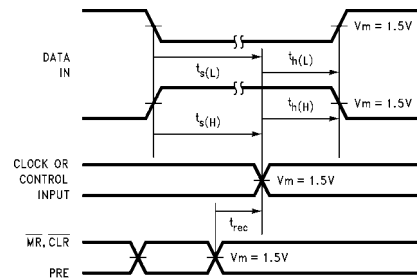
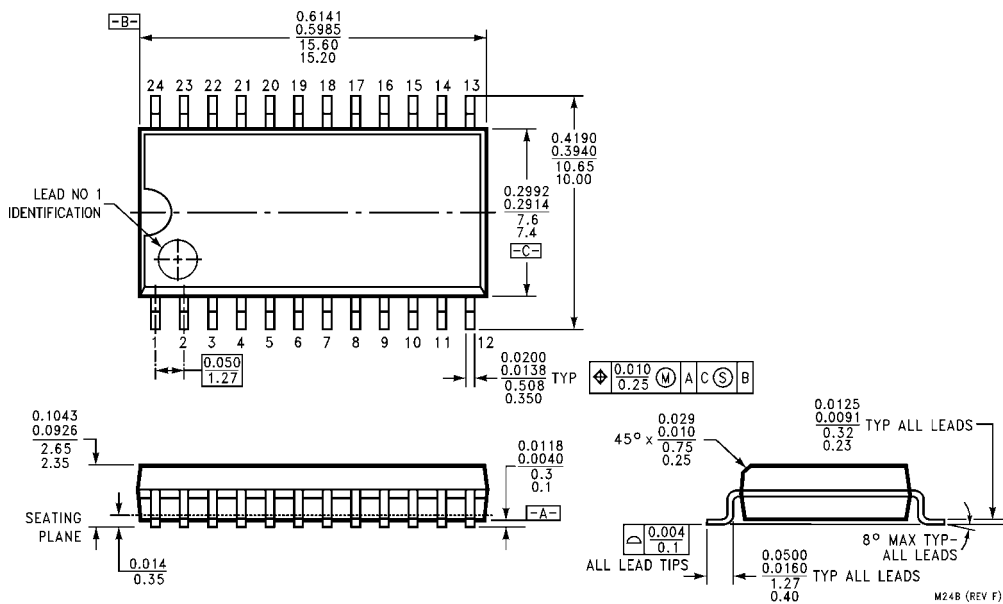
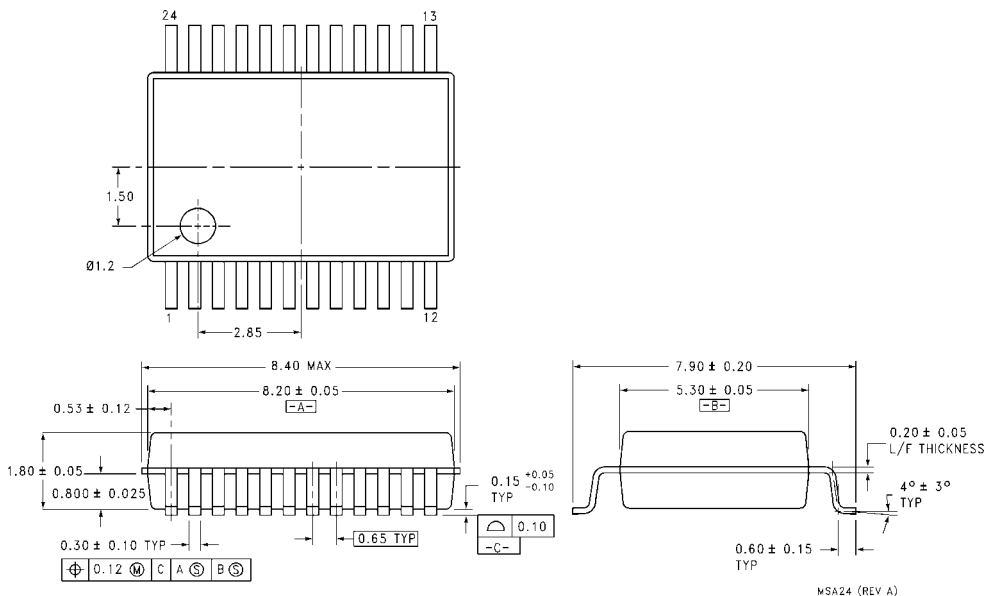

FIGURE 7. Setup Time, Hold Time and Recovery Time Waveforms

**Physical Dimensions** inches (millimeters) unless otherwise noted



**24-Lead Small Outline Integrated Circuit (SOIC), JEDEC MS-013, 0.300" Wide Body Package Number M24B**



**24-Lead Shrink Small Outline Package (SSOP), EIAJ TYPE II, 5.3mm Wide Package Number MSA24**

**Physical Dimensions** inches (millimeters) unless otherwise noted (Continued)

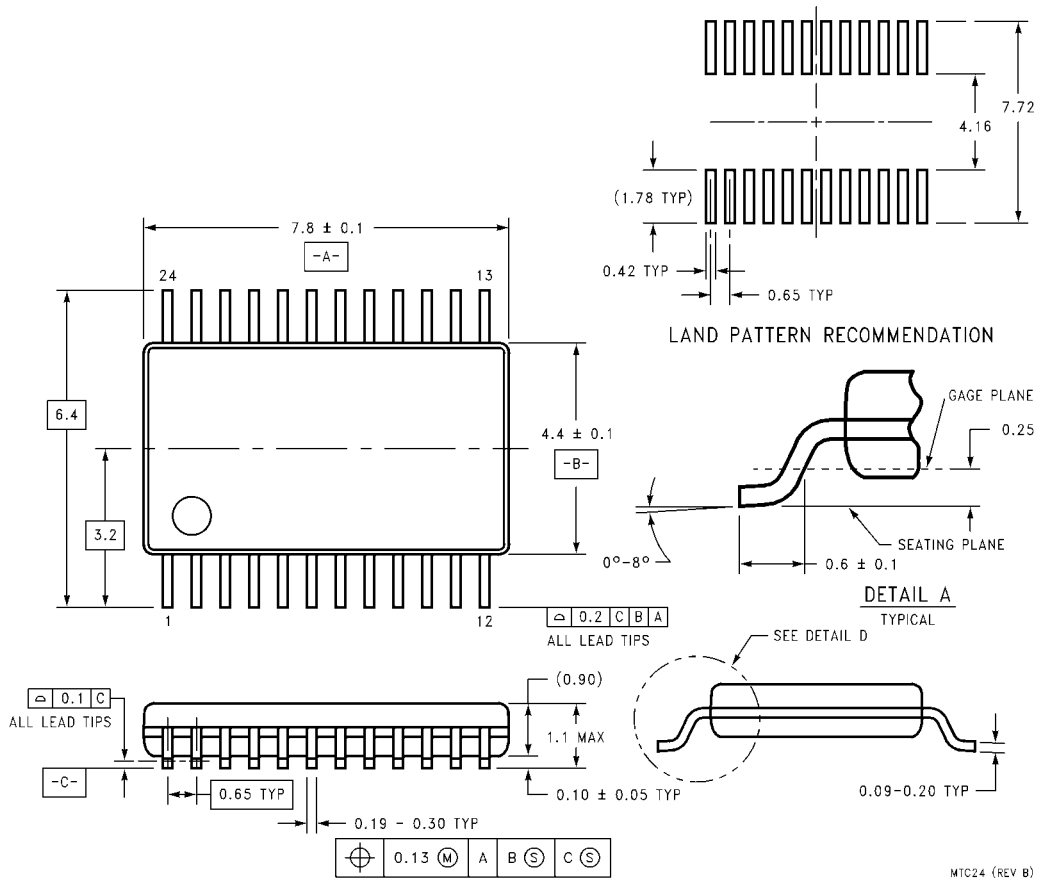

**24-Lead Thin Shrink Small Outline Package (TSSOP), JEDEC MO-153, 4.4mm Wide  
Package Number MTC24**

MTC24 (REV B)

**LIFE SUPPORT POLICY**

FAIRCHILD'S PRODUCTS ARE NOT AUTHORIZED FOR USE AS CRITICAL COMPONENTS IN LIFE SUPPORT DEVICES OR SYSTEMS WITHOUT THE EXPRESS WRITTEN APPROVAL OF THE PRESIDENT OF FAIRCHILD SEMICONDUCTOR CORPORATION. As used herein:

1. Life support devices or systems are devices or systems which, (a) are intended for surgical implant into the body, or (b) support or sustain life, and (c) whose failure to perform when properly used in accordance with instructions for use provided in the labeling, can be reasonably expected to result in a significant injury to the user.
2. A critical component in any component of a life support device or system whose failure to perform can be reasonably expected to cause the failure of the life support device or system, or to affect its safety or effectiveness.

[www.fairchildsemi.com](http://www.fairchildsemi.com)

## Looking for pricing, stock, or lifecycle information?

Click below to explore more details on WIN SOURCE:

-  [View 74ABT543CMTC on WIN SOURCE](#)
-  [Fairchild/ON Semiconductor Information](#)

## Optimize Your Supply Chain with WIN SOURCE Solutions

-  Global Sourcing Solution
-  Obsolete Management
-  Cost Control Management
-  Shortage Management
-  Alternative Solution
-  Excess Inventory Management