

High Frequency NPN Transistor Array

The CA3127 consists of five general purpose silicon NPN transistors on a common monolithic substrate. Each of the completely isolated transistors exhibits low 1/f noise and a value of f_T in excess of 1GHz, making the CA3127 useful from DC to 500MHz. Access is provided to each of the terminals for the individual transistors and a separate substrate connection has been provided for maximum application flexibility. The monolithic construction of the CA3127 provides close electrical and thermal matching of the five transistors.

Ordering Information

PART NUMBER	PART MARKING	TEMP. RANGE (°C)	PACKAGE	PKG. DWG. #
CA3127M	CA3127	-55 to 125	16 Ld SOIC	M16.15
CA3127MZ (Note)	CA3127MZ	-55 to 125	16 Ld SOIC (Pb-free)	M16.15

NOTE: Intersil Pb-free plus anneal products employ special Pb-free material sets; molding compounds/die attach materials and 100% matte tin plate termination finish, which are RoHS compliant and compatible with both SnPb and Pb-free soldering operations. Intersil Pb-free products are MSL classified at Pb-free peak reflow temperatures that meet or exceed the Pb-free requirements of IPC/JEDEC J STD-020.

Features

- Gain Bandwidth Product (f_T) >1GHz
- Power Gain 30dB (Typ) at 100MHz
- Noise Figure. 3.5dB (Typ) at 100MHz
- Five Independent Transistors on a Common Substrate
- Pb-Free Plus Anneal Available (RoHS Compliant)

Applications

- VHF Amplifiers
- Multifunction Combinations - RF/Mixer/Oscillator
- Sense Amplifiers
- Synchronous Detectors
- VHF Mixers
- IF Converter
- IF Amplifiers
- Synthesizers
- Cascade Amplifiers

Pinout

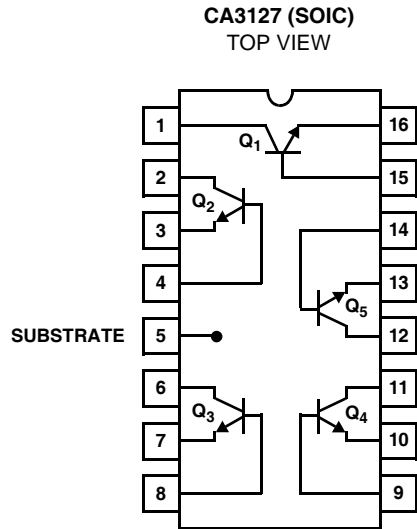

CA3127

Absolute Maximum Ratings

The following ratings apply for each transistor in the device

Collector-to-Emitter Voltage, V_{CEO} 15V
 Collector-to-Base Voltage, V_{CBO} 20V
 Collector-to-Substrate Voltage, V_{C1O} (Note 1) 20V
 Collector Current, I_C 20mA

Thermal Information

Thermal Resistance (Typical, Note 2) θ_{JA} (°C/W)

SOIC Package 120

Maximum Power Dissipation, P_D (Any One Transistor) 85mW
 Maximum Junction Temperature (Die) 175°C
 Maximum Junction Temperature (Plastic Packages) 150°C
 Maximum Storage Temperature Range -65°C to 150°C
 Maximum Lead Temperature (Soldering 10s) 300°C
 (SOIC - Lead Tips Only)

Operating Conditions

Temperature Range -55°C to 125°C

CAUTION: Stresses above those listed in "Absolute Maximum Ratings" may cause permanent damage to the device. This is a stress only rating and operation of the device at these or any other conditions above those indicated in the operational sections of this specification is not implied.

NOTES:

1. The collector of each transistor of the CA3127 is isolated from the substrate by an integral diode. The substrate (Terminal 5) must be connected to the most negative point in the external circuit to maintain isolation between transistors and to provide for normal transistor action.
2. θ_{JA} is measured with the component mounted on an evaluation PC board in free air.

Electrical Specifications $T_A = 25^\circ\text{C}$

PARAMETER	TEST CONDITIONS	MIN	TYP	MAX	UNITS	
DC CHARACTERISTICS (For Each Transistor)						
Collector-to-Base Breakdown Voltage	$I_C = 10\mu\text{A}, I_E = 0$	20	32	-	V	
Collector-to-Emitter Breakdown Voltage	$I_C = 1\text{mA}, I_B = 0$	15	24	-	V	
Collector-to-Substrate Breakdown-Voltage	$I_{C1} = 10\mu\text{A}, I_B = 0, I_E = 0$	20	60	-	V	
Emitter-to-Base Breakdown Voltage (Note 3)	$I_E = 10\mu\text{A}, I_C = 0$	4	5.7	-	V	
Collector-Cutoff-Current	$V_{CE} = 10\text{V}, I_B = 0$	-	-	0.5	μA	
Collector-Cutoff-Current	$V_{CB} = 10\text{V}, I_E = 0$	-	-	40	nA	
DC Forward-Current Transfer Ratio	$V_{CE} = 6\text{V}$	$I_C = 5\text{mA}$	35	88	-	
		$I_C = 1\text{mA}$	40	90	-	
		$I_C = 0.1\text{mA}$	35	85	-	
Base-to-Emitter Voltage	$V_{CE} = 6\text{V}$	$I_C = 5\text{mA}$	0.71	0.81	0.91	V
		$I_C = 1\text{mA}$	0.66	0.76	0.86	V
		$I_C = 0.1\text{mA}$	0.60	0.70	0.80	V
Collector-to-Emitter Saturation Voltage	$I_C = 10\text{mA}, I_B = 1\text{mA}$	-	0.26	0.50	V	
Magnitude of Difference in V_{BE}	Q_1 and Q_2 Matched	-	0.5	5	mV	
Magnitude of Difference in I_B	$V_{CE} = 6\text{V}, I_C = 1\text{mA}$	-	0.2	3	μA	
DYNAMIC CHARACTERISTICS						
Noise Figure	$f = 100\text{kHz}, R_S = 500\Omega, I_C = 1\text{mA}$	-	2.2	-	dB	
Gain-Bandwidth Product	$V_{CE} = 6\text{V}, I_C = 5\text{mA}$	-	1.15	-	GHz	
Collector-to-Base Capacitance	$V_{CB} = 6\text{V}, f = 1\text{MHz}$	-	See Fig. 5	-	pF	
Collector-to-Substrate Capacitance	$V_{C1} = 6\text{V}, f = 1\text{MHz}$	-		-	pF	
Emitter-to-Base Capacitance	$V_{BE} = 4\text{V}, f = 1\text{MHz}$	-		-	pF	
Voltage Gain	$V_{CE} = 6\text{V}, f = 10\text{MHz}, R_L = 1\text{k}\Omega, I_C = 1\text{mA}$	-	28	-	dB	
Power Gain	Cascode Configuration	27	30	-	dB	
Noise Figure	$f = 100\text{MHz}, V_+ = 12\text{V}, I_C = 1\text{mA}$	-	3.5	-	dB	

Electrical Specifications $T_A = 25^\circ\text{C}$

PARAMETER	TEST CONDITIONS	MIN	TYP	MAX	UNITS
Input Resistance	Common-Emitter Configuration $V_{CE} = 6\text{V}$, $I_C = 1\text{mA}$, $f = 200\text{MHz}$	-	400	-	Ω
Output Resistance		-	4.6	-	$\text{k}\Omega$
Input Capacitance		-	3.7	-	pF
Output Capacitance		-	2	-	pF
Magnitude of Forward Transadmittance		-	24	-	mS

NOTE:

- When used as a zener for reference voltage, the device must not be subjected to more than 0.1mJ of energy from any possible capacitance or electrostatic discharge in order to prevent degradation of the junction. Maximum operating zener current should be less than 10mA.

Test Circuits

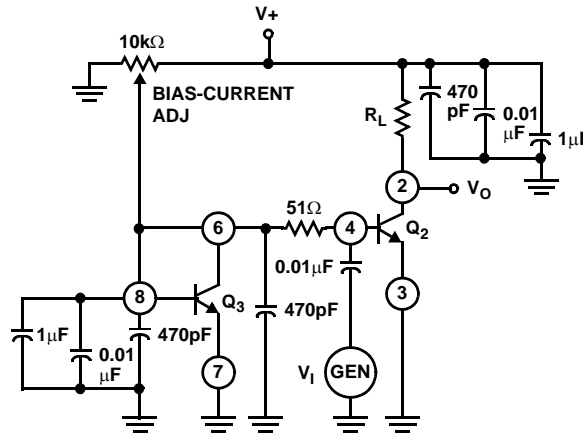
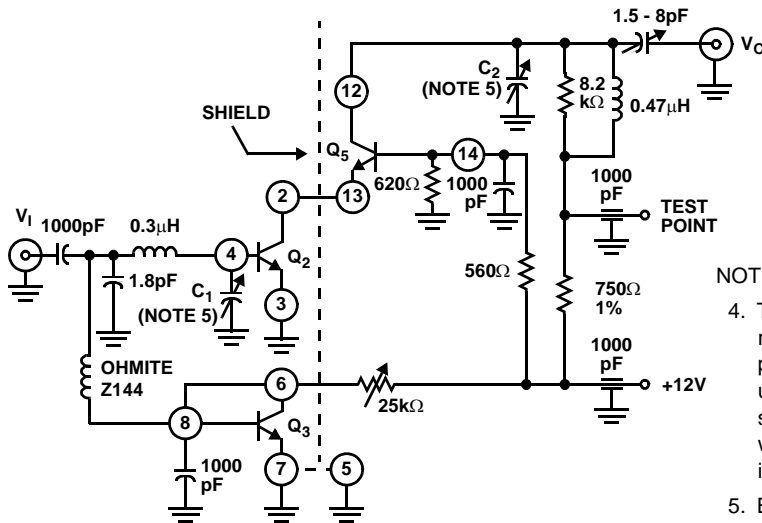

FIGURE 1. VOLTAGE-GAIN TEST CIRCUIT USING CURRENT-MIRROR BIASING FOR Q_2



NOTES:

- This circuit was chosen because it conveniently represents a close approximation in performance to a properly unilateralized single transistor of this type. The use of Q_3 in a current-mirror configuration facilitates simplified biasing. The use of the cascode circuit in no way implies that the transistors cannot be used individually.
- E.F. Johnson number 160-104-1 or equivalent.

FIGURE 2. 100MHz POWER-GAIN AND NOISE-FIGURE TEST CIRCUIT

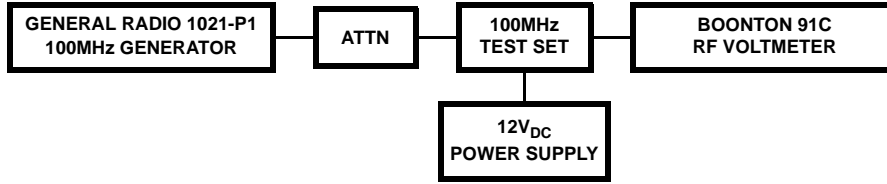

FIGURE 3A. POWER GAIN SET-UP

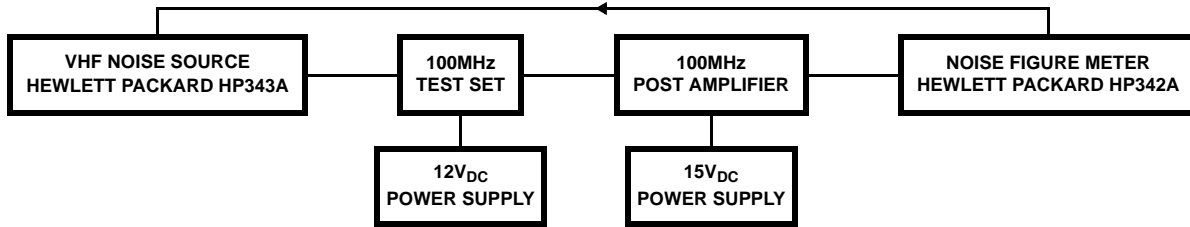

FIGURE 3B. NOISE FIGURE SET-UP

FIGURE 3. BLOCK DIAGRAMS OF POWER-GAIN AND NOISE-FIGURE TEST SET-UPS

Typical Performance Curves

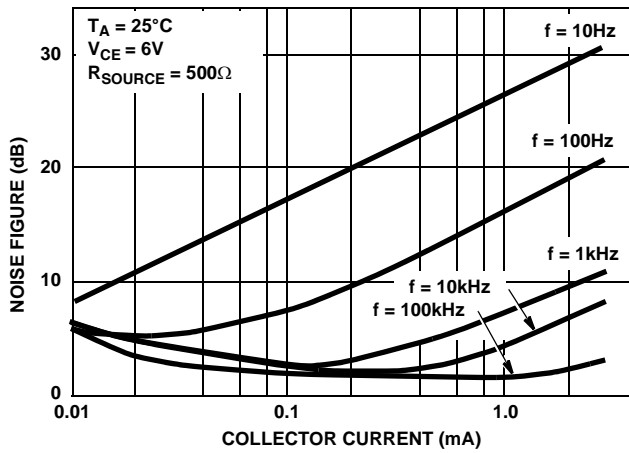

FIGURE 4. NOISE FIGURE vs COLLECTOR CURRENT

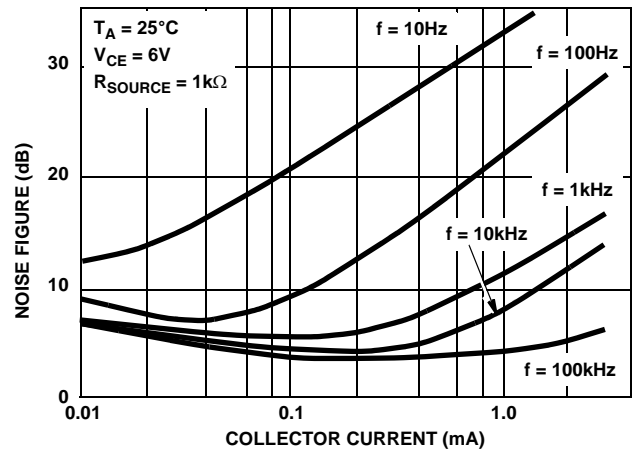

FIGURE 5. NOISE FIGURE vs COLLECTOR CURRENT

Typical Performance Curves (Continued)

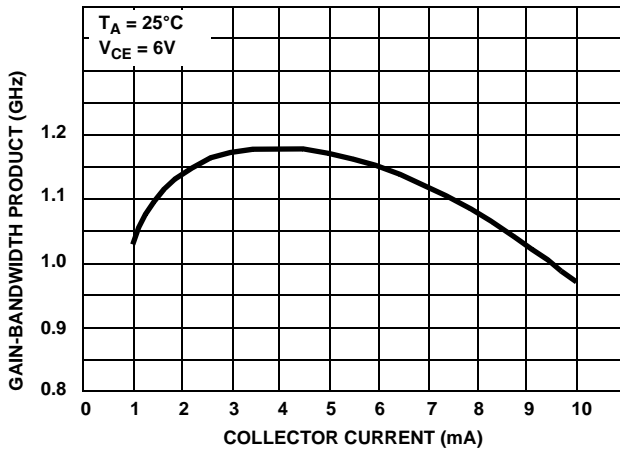

FIGURE 6. GAIN-BANDWIDTH PRODUCT vs COLLECTOR CURRENT

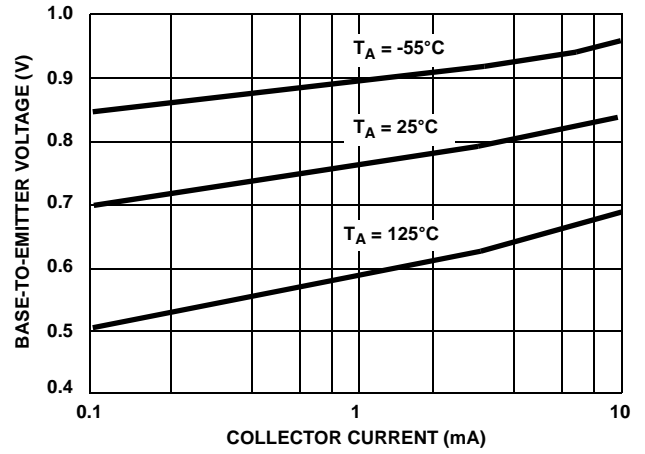

FIGURE 7. BASE-TO-EMITTER VOLTAGE vs COLLECTOR CURRENT

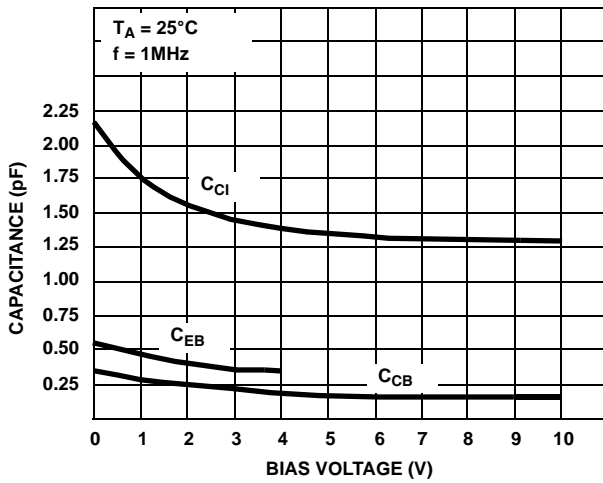

FIGURE 8A. CAPACITANCE vs BIAS VOLTAGE FOR Q₂

TRAN-SISTOR	CAPACITANCE (pF)							
	C _{CB}		C _{CE}		C _{EB}		C _{Cl}	
BIAS (V)	PKG	TOTAL	PKG	TOTAL	PKG	TOTAL	PKG	TOTAL
Q ₁	-	6V	-	6V	-	4V	-	6V
Q ₁	0.025	0.190	0.090	0.125	0.365	0.610	0.475	1.65
Q ₂	0.015	0.170	0.225	0.265	0.130	0.360	0.085	1.35
Q ₃	0.040	0.200	0.215	0.240	0.360	0.625	0.210	1.40
Q ₄	0.040	0.190	0.225	0.270	0.365	0.610	0.085	1.25
Q ₅	0.010	0.165	0.095	0.115	0.140	0.365	0.090	1.35

FIGURE 8B. TYPICAL CAPACITANCE VALUES AT f = 1MHz. THREE TERMINAL MEASUREMENT. GUARD ALL TERMINALS EXCEPT THOSE UNDER TEST.

Typical Performance Curves (Continued)

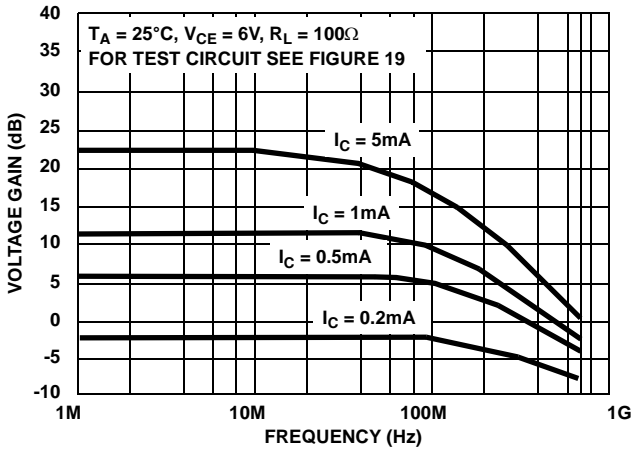

FIGURE 9. VOLTAGE GAIN vs FREQUENCY

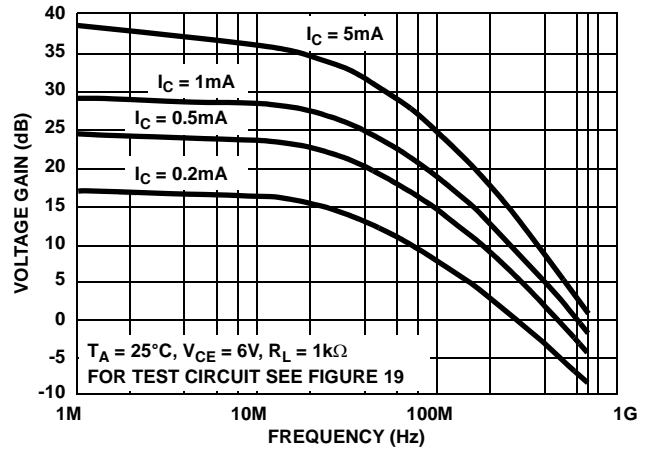

FIGURE 10. VOLTAGE GAIN vs FREQUENCY

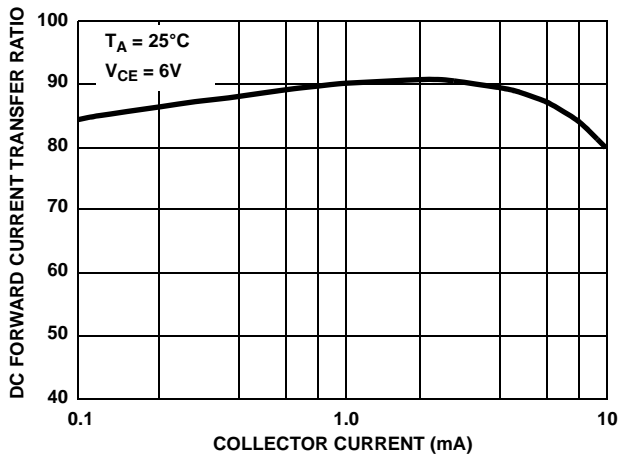

FIGURE 11. DC FORWARD-CURRENT TRANSFER RATIO (h_{FE}) vs COLLECTOR CURRENT

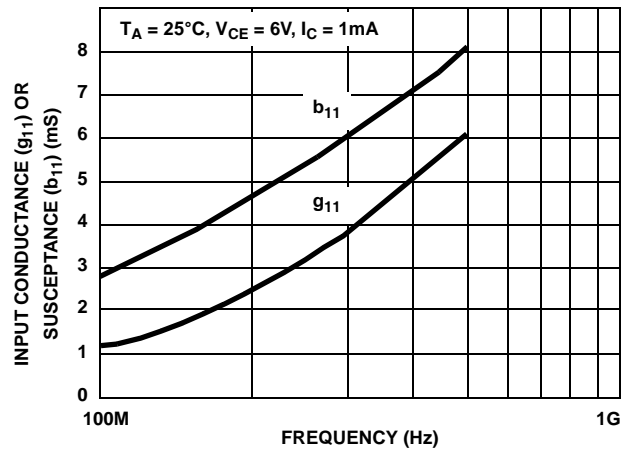

FIGURE 12. INPUT ADMITTANCE (Y_{11}) vs FREQUENCY

Typical Performance Curves (Continued)

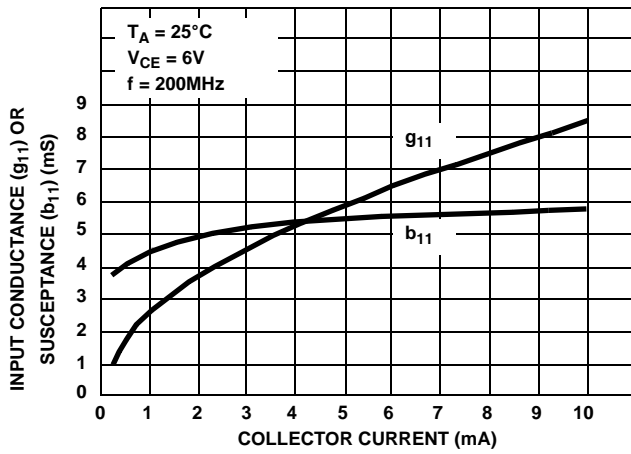

FIGURE 13. INPUT ADMITTANCE (Y_{11}) vs COLLECTOR CURRENT

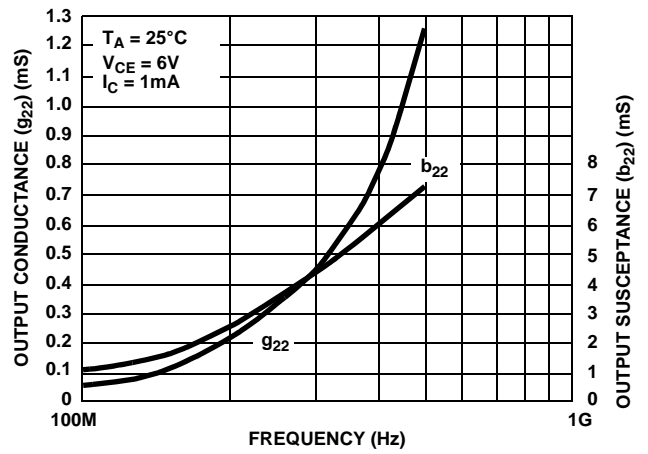

FIGURE 14. OUTPUT ADMITTANCE (Y_{22}) vs FREQUENCY

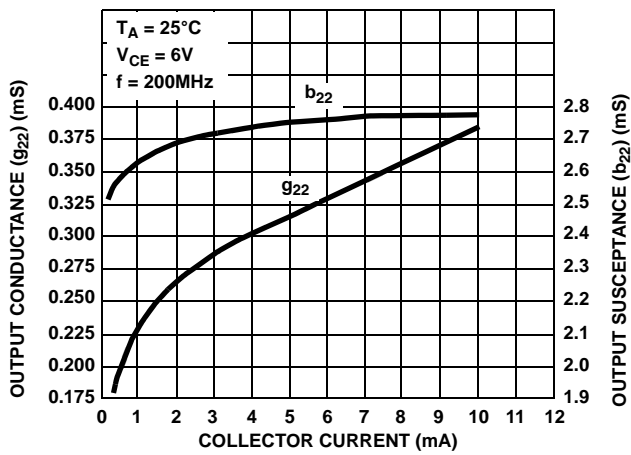

FIGURE 15. OUTPUT ADMITTANCE (Y_{22}) vs COLLECTOR CURRENT

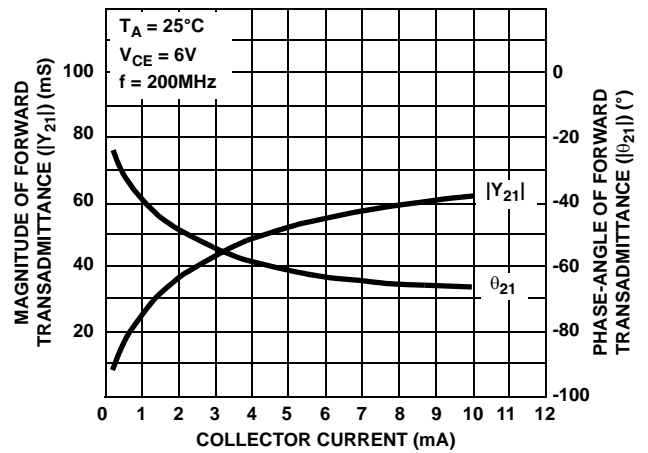

FIGURE 16. FORWARD TRANSADMITTANCE (Y_{21}) vs COLLECTOR CURRENT

Typical Performance Curves (Continued)

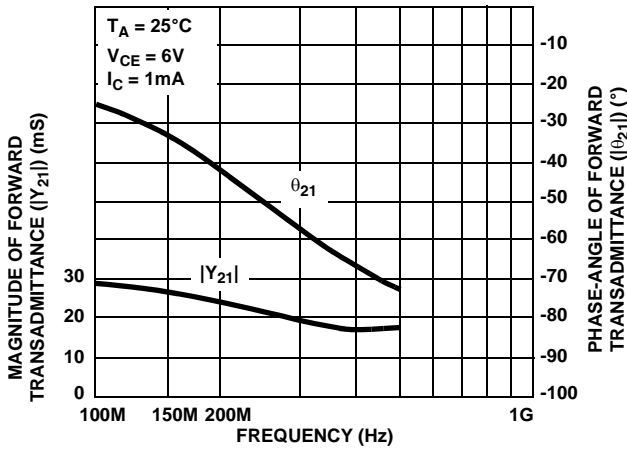

FIGURE 17. FORWARD TRANSADMITTANCE (Y_{21}) vs FREQUENCY

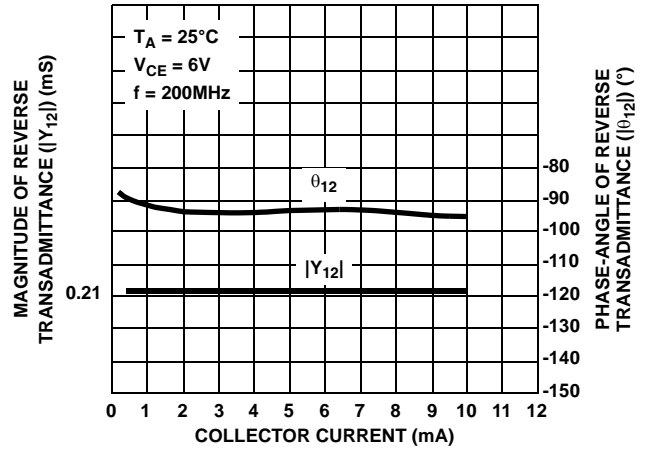

FIGURE 18. REVERSE TRANSADMITTANCE (Y_{12}) vs COLLECTOR CURRENT

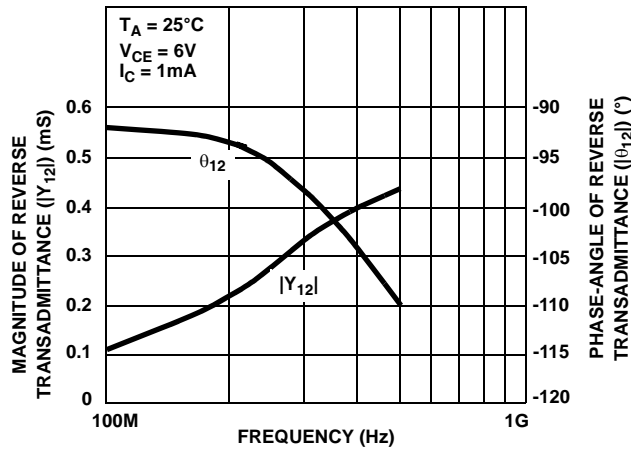
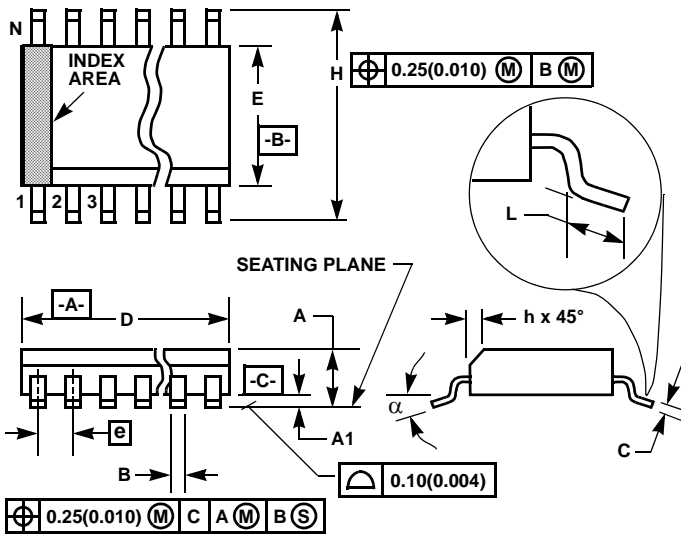

FIGURE 19. REVERSE TRANSADMITTANCE (Y_{12}) vs FREQUENCY

Small Outline Plastic Packages (SOIC)



M16.15 (JEDEC MS-012-AC ISSUE C)
16 LEAD NARROW BODY SMALL OUTLINE PLASTIC PACKAGE

SYMBOL	INCHES		MILLIMETERS		NOTES
	MIN	MAX	MIN	MAX	
A	0.0532	0.0688	1.35	1.75	-
A1	0.0040	0.0098	0.10	0.25	-
B	0.013	0.020	0.33	0.51	9
C	0.0075	0.0098	0.19	0.25	-
D	0.3859	0.3937	9.80	10.00	3
E	0.1497	0.1574	3.80	4.00	4
e	0.050 BSC		1.27 BSC		-
H	0.2284	0.2440	5.80	6.20	-
h	0.0099	0.0196	0.25	0.50	5
L	0.016	0.050	0.40	1.27	6
N	16		16		7
α	0°	8°	0°	8°	-

NOTES:

1. Symbols are defined in the "MO Series Symbol List" in Section 2.2 of Publication Number 95.
2. Dimensioning and tolerancing per ANSI Y14.5M-1982.
3. Dimension "D" does not include mold flash, protrusions or gate burrs. Mold flash, protrusion and gate burrs shall not exceed 0.15mm (0.006 inch) per side.
4. Dimension "E" does not include interlead flash or protrusions. Interlead flash and protrusions shall not exceed 0.25mm (0.010 inch) per side.
5. The chamfer on the body is optional. If it is not present, a visual index feature must be located within the crosshatched area.
6. "L" is the length of terminal for soldering to a substrate.
7. "N" is the number of terminal positions.
8. Terminal numbers are shown for reference only.
9. The lead width "B", as measured 0.36mm (0.014 inch) or greater above the seating plane, shall not exceed a maximum value of 0.61mm (0.024 inch).
10. Controlling dimension: MILLIMETER. Converted inch dimensions are not necessarily exact.

Rev. 1 6/05



All Intersil U.S. products are manufactured, assembled and tested utilizing ISO9000 quality systems.
 Intersil Corporation's quality certifications can be viewed at www.intersil.com/design/quality

Intersil products are sold by description only. Intersil Corporation reserves the right to make changes in circuit design, software and/or specifications at any time without notice. Accordingly, the reader is cautioned to verify that data sheets are current before placing orders. Information furnished by Intersil is believed to be accurate and reliable. However, no responsibility is assumed by Intersil or its subsidiaries for its use; nor for any infringements of patents or other rights of third parties which may result from its use. No license is granted by implication or otherwise under any patent or patent rights of Intersil or its subsidiaries.

For information regarding Intersil Corporation and its products, see www.intersil.com

Looking for pricing, stock, or lifecycle information?

Click below to explore more details on WIN SOURCE:

-  [View CA3127M on WIN SOURCE](#)
-  [Renesas Electronics America](#) Information

Optimize Your Supply Chain with WIN SOURCE Solutions

-  Global Sourcing Solution
-  Obsolete Management
-  Cost Control Management
-  Shortage Management
-  Alternative Solution
-  Excess Inventory Management