

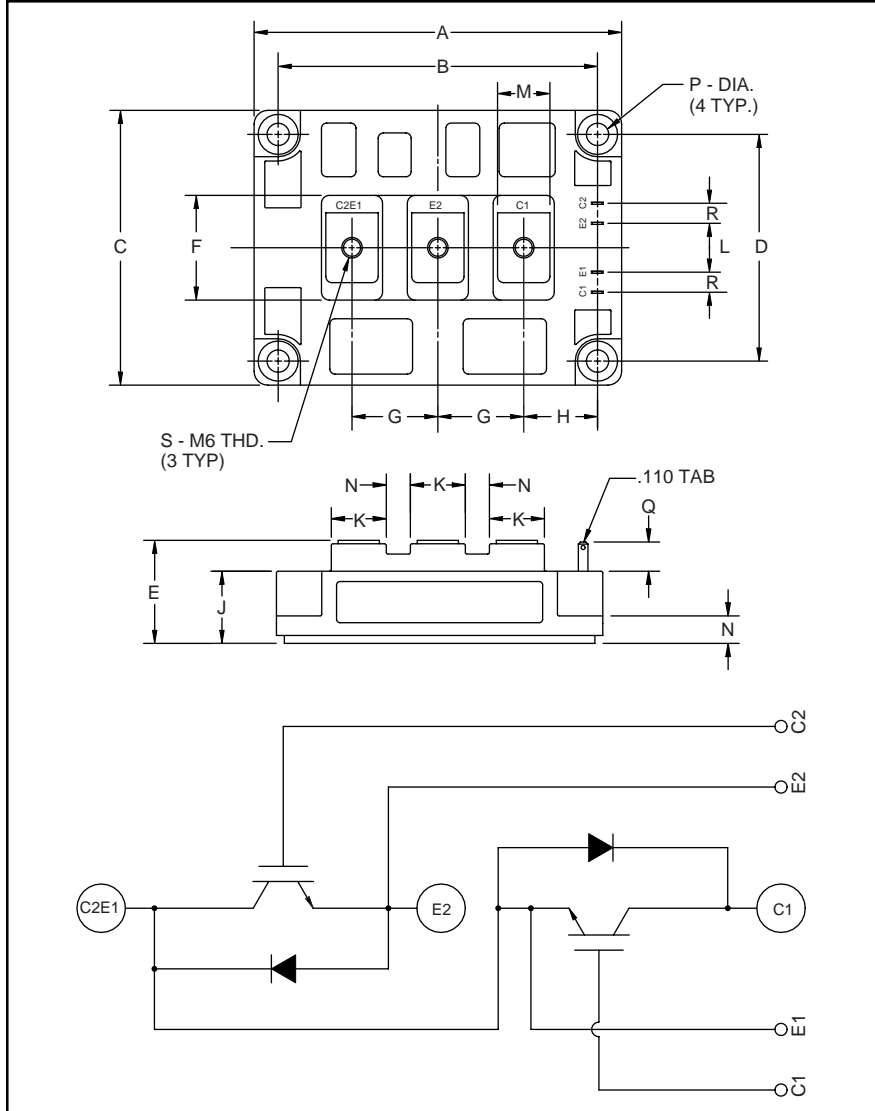

**THE DATASHEET OF  
CM300DY-28H**



### Dual IGBTMOD™ H-Series Module 300 Amperes/1400 Volts



Outline Drawing and Circuit Diagram

Dimensions	Inches	Millimeters
A	4.33	110.0
B	3.661±0.01	93.0±0.25
C	3.15	80.0
D	2.441±0.01	62.0±0.25
E	1.18 Max.	30.0 Max.
F	1.18	30.0
G	0.98	25.0
H	0.85	21.5
J	0.83	21.2

Dimensions	Inches	Millimeters
K	0.71	18.0
L	0.59	15.0
M	0.55	14.0
N	0.28	7.0
P	0.26 Dia.	Dia. 6.5
Q	0.33	8.5
R	0.24	6.0
S	M6 Metric	M6



#### Description:

Powerex IGBTMOD™ Modules are designed for use in switching applications. Each module consists of two IGBT Transistors in a half-bridge configuration with each transistor having a reverse-connected super-fast recovery free-wheel diode. All components and interconnects are isolated from the heat sinking baseplate, offering simplified system assembly and thermal management.

#### Features:

- Low Drive Power
- Low  $V_{CE(sat)}$
- Discrete Super-Fast Recovery (135ns) Free-Wheel Diode
- High Frequency Operation (20-25kHz)
- Isolated Baseplate for Easy Heat Sinking

#### Applications:

- AC Motor Control
- Motion/Servo Control
- UPS
- Welding Power Supplies
- Laser Power Supplies

#### Ordering Information:

Example: Select the complete part module number you desire from the table below -i.e. CM300DY-28H is a 1400V ( $V_{CES}$ ), 300 Ampere Dual IGBTMOD™ Power Module.

Type	Current Rating Amperes	$V_{CES}$ Volts (x 50)
CM	300	28

**CM300DY-28H**  
**Dual IGBTMOD™ H-Series Module**  
 300 Amperes/1400 Volts

**Absolute Maximum Ratings,  $T_j = 25\text{ }^\circ\text{C}$  unless otherwise specified**

Ratings	Symbol	CM300DY-28H	Units
Junction Temperature	$T_j$	-40 to 150	$^\circ\text{C}$
Storage Temperature	$T_{\text{stg}}$	-40 to 125	$^\circ\text{C}$
Collector-Emitter Voltage (G-E SHORT)	$V_{\text{CES}}$	1400	Volts
Gate-Emitter Voltage	$V_{\text{GES}}$	$\pm 20$	Volts
Collector Current	$I_C$	300	Amperes
Peak Collector Current	$I_{\text{CM}}$	600*	Amperes
Diode Forward Current	$I_F$	300	Amperes
Diode Forward Surge Current	$I_{\text{FM}}$	600*	Amperes
Power Dissipation	$P_d$	2100	Watts
Max. Mounting Torque M6 Terminal Screws	-	26	in-lb
Max. Mounting Torque M6 Mounting Screws	-	26	in-lb
Module Weight (Typical)	-	500	Grams
V Isolation	$V_{\text{RMS}}$	2500	Volts

\* Pulse width and repetition rate should be such that device junction temperature does not exceed the device rating.

**Static Electrical Characteristics,  $T_j = 25\text{ }^\circ\text{C}$  unless otherwise specified**

Characteristics	Symbol	Test Conditions	Min.	Typ.	Max.	Units
Collector-Cutoff Current	$I_{\text{CES}}$	$V_{\text{CE}} = V_{\text{CES}}, V_{\text{GE}} = 0\text{V}$	-	-	1.0	mA
Gate Leakage Current	$I_{\text{GES}}$	$V_{\text{GE}} = V_{\text{GES}}, V_{\text{CE}} = 0\text{V}$	-	-	0.5	$\mu\text{A}$
Gate-Emitter Threshold Voltage	$V_{\text{GE(th)}}$	$I_C = 30\text{mA}, V_{\text{CE}} = 10\text{V}$	5.0	6.5	8.0	Volts
Collector-Emitter Saturation Voltage	$V_{\text{CE(sat)}}$	$I_C = 300\text{A}, V_{\text{GE}} = 15\text{V}$	-	3.1	4.2**	Volts
		$I_C = 300\text{A}, V_{\text{GE}} = 15\text{V}, T_j = 150\text{ }^\circ\text{C}$	-	2.95	-	Volts
Total Gate Charge	$Q_G$	$V_{\text{CC}} = 600\text{V}, I_C = 300\text{A}, V_{\text{GE}} = 15\text{V}$	-	1530	-	nC
Diode Forward Voltage	$V_{\text{FM}}$	$I_E = 300\text{A}, V_{\text{GE}} = 0\text{V}$	-	-	3.8	Volts

\*\* Pulse width and repetition rate should be such that device junction temperature rise is negligible.

**Dynamic Electrical Characteristics,  $T_j = 25\text{ }^\circ\text{C}$  unless otherwise specified**

Characteristics	Symbol	Test Conditions	Min.	Typ.	Max.	Units
Input Capacitance	$C_{\text{ies}}$		-	-	60	nF
Output Capacitance	$C_{\text{Oes}}$	$V_{\text{GE}} = 0\text{V}, V_{\text{CE}} = 10\text{V}, f = 1\text{MHz}$	-	-	21	nF
Reverse Transfer Capacitance	$C_{\text{res}}$		-	-	12	nF
Resistive	Turn-on Delay Time	$t_{\text{d(on)}}$	-	-	250	ns
	Rise Time	$t_r$	-	-	500	ns
Switching	Turn-off Delay Time	$t_{\text{d(off)}}$	-	-	350	ns
	Fall Time	$t_f$	-	-	500	ns
Diode Reverse Recovery Time	$t_{\text{rr}}$	$I_E = 300\text{A}, di_E/dt = -600\text{A}/\mu\text{s}$	-	-	300	ns
Diode Reverse Recovery Charge	$Q_{\text{rr}}$	$I_E = 300\text{A}, di_E/dt = -600\text{A}/\mu\text{s}$	-	3.0	-	$\mu\text{C}$

**Thermal and Mechanical Characteristics,  $T_j = 25\text{ }^\circ\text{C}$  unless otherwise specified**

Characteristics	Symbol	Test Conditions	Min.	Typ.	Max.	Units
Thermal Resistance, Junction to Case	$R_{\text{th(j-c)}}$	Per IGBT	-	-	0.06	$^\circ\text{C}/\text{W}$
Thermal Resistance, Junction to Case	$R_{\text{th(j-c)}}$	Per FWDi	-	-	0.12	$^\circ\text{C}/\text{W}$
Contact Thermal Resistance	$R_{\text{th(c-f)}}$	Per Module, Thermal Grease Applied	-	-	0.035	$^\circ\text{C}/\text{W}$



Powerex, Inc., 200 Hillis Street, Youngwood, Pennsylvania 15697-1800 (724) 925-7272

**CM300DY-28H**  
**Dual IGBTMOD™ H-Series Module**  
 300 Amperes/1400 Volts

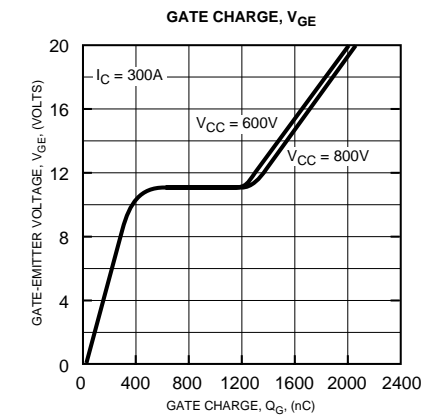
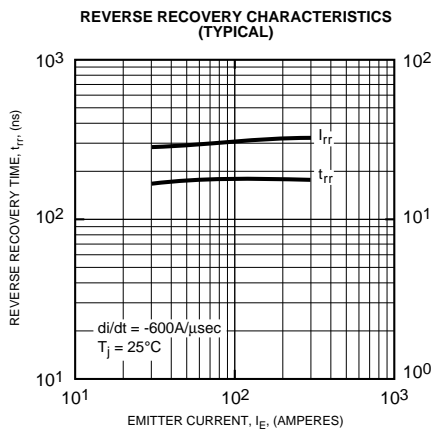
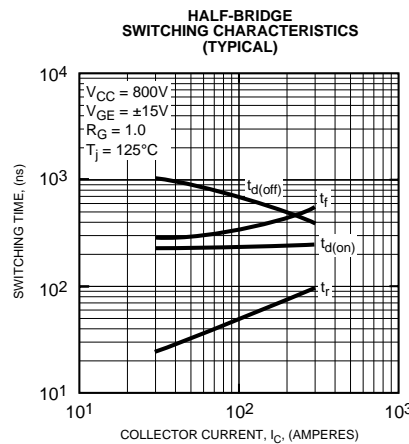
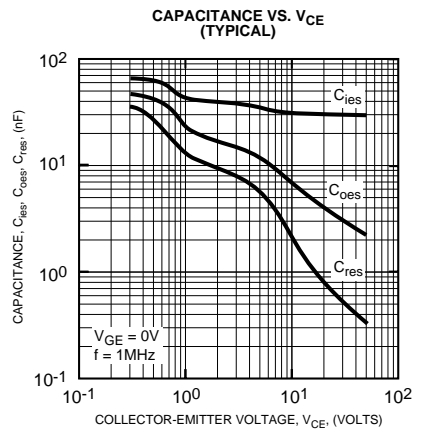
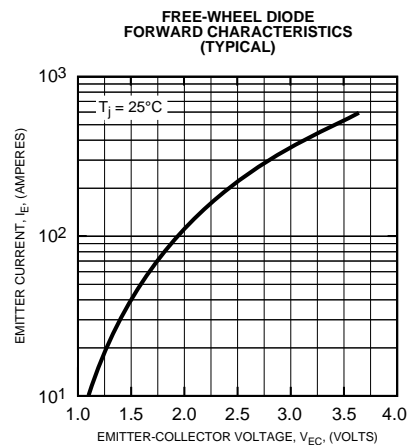
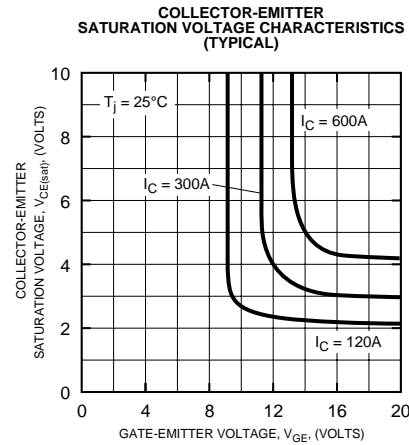
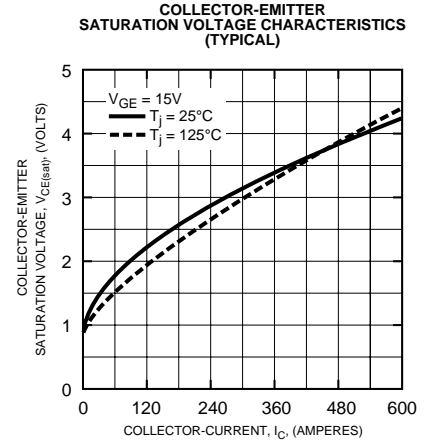
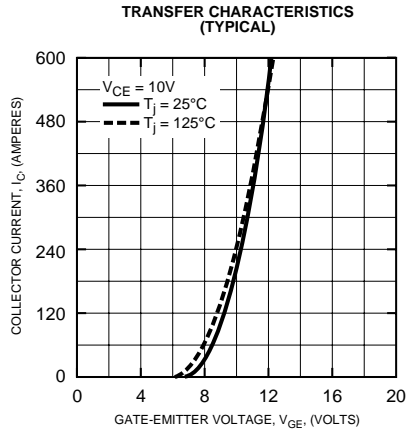
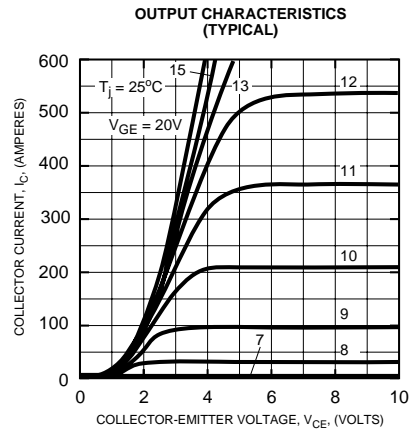

**CM300DY-28H**  
**Dual IGBTMOD™ H-Series Module**  
 300 Amperes/1400 Volts

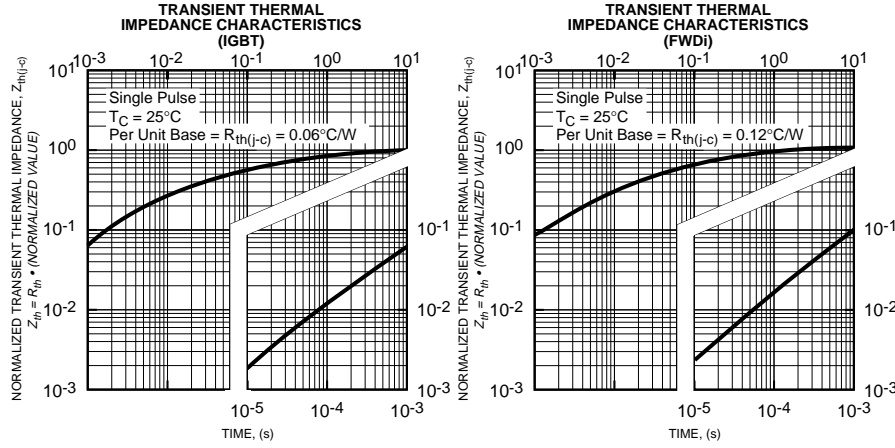

## Looking for pricing, stock, or lifecycle information?

Click below to explore more details on WIN SOURCE:

 [View CM300DY-28H on WIN SOURCE](#)

 [Powerex Inc. Information](#)

## Optimize Your Supply Chain with WIN SOURCE Solutions

-  Global Sourcing Solution
-  Obsolete Management
-  Cost Control Management
-  Shortage Management
-  Alternative Solution
-  Excess Inventory Management