



**THE DATASHEET OF
MRF7S18125AHSR3**



RF Power Field Effect Transistors

N-Channel Enhancement-Mode Lateral MOSFETs

Designed for GSM and GSM EDGE base station applications with frequencies from 1800 to 2000 MHz. Can be used in Class AB and Class C for all typical cellular base station modulations.

GSM Application

- Typical GSM Performance: $V_{DD} = 28$ Volts, $I_{DQ} = 1100$ mA, $P_{out} = 125$ Watts CW, $f = 1880$ MHz.
Power Gain — 17 dB
Drain Efficiency — 55%

GSM EDGE Application

- Typical GSM EDGE Performance: $V_{DD} = 28$ Volts, $I_{DQ} = 1100$ mA, $P_{out} = 57$ Watts Avg., Full Frequency Band (1805-1880 MHz).
Power Gain — 17 dB
Drain Efficiency — 38%
Spectral Regrowth @ 400 kHz Offset = -63 dBc
Spectral Regrowth @ 600 kHz Offset = -75 dBc
EVM — 1.75% rms
- Capable of Handling 5:1 VSWR, @ 28 Vdc, 1840 MHz, 125 Watts CW Output Power
- Typical P_{out} @ 1 dB Compression Point ≈ 140 Watts CW

Features

- Characterized with Series Equivalent Large-Signal Impedance Parameters
- Internally Matched for Ease of Use
- Integrated ESD Protection
- RoHS Compliant
- In Tape and Reel. R3 Suffix = 250 Units per 56 mm, 13 inch Reel.

MRF7S18125AHR3
MRF7S18125AHSR3

1805-1880 MHz, 125 W CW, 28 V
GSM, GSM EDGE
LATERAL N-CHANNEL
RF POWER MOSFETs

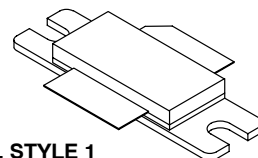

CASE 465-06, STYLE 1
NI-780
MRF7S18125AHR3

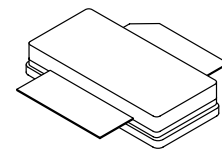

CASE 465A-06, STYLE 1
NI-780S
MRF7S18125AHSR3

Table 1. Maximum Ratings

Rating	Symbol	Value	Unit
Drain-Source Voltage	V_{DSS}	-0.5, +65	Vdc
Gate-Source Voltage	V_{GS}	-6.0, +10	Vdc
Operating Voltage	V_{DD}	32, +0	Vdc
Storage Temperature Range	T_{stg}	-65 to +150	°C
Case Operating Temperature	T_C	150	°C
Operating Junction Temperature (1,2)	T_J	225	°C

Table 2. Thermal Characteristics

Characteristic	Symbol	Value (2,3)	Unit
Thermal Resistance, Junction to Case Case Temperature 80°C, 125 W CW Case Temperature 80°C, 71 W CW	$R_{\theta JC}$	0.31 0.34	°C/W

1. Continuous use at maximum temperature will affect MTTF.
2. MTTF calculator available at <http://www.freescale.com/rf>. Select Software & Tools/Development Tools/Calculators to access MTTF calculators by product.
3. Refer to AN1955, *Thermal Measurement Methodology of RF Power Amplifiers*. Go to <http://www.freescale.com/rf>. Select Documentation/Application Notes - AN1955.

Table 3. ESD Protection Characteristics

Test Methodology	Class
Human Body Model (per JESD22-A114)	1B (Minimum)
Machine Model (per EIA/JESD22-A115)	A (Minimum)
Charge Device Model (per JESD22-C101)	IV (Minimum)

Table 4. Electrical Characteristics ($T_C = 25^\circ\text{C}$ unless otherwise noted)

Characteristic	Symbol	Min	Typ	Max	Unit
----------------	--------	-----	-----	-----	------

Off Characteristics

Zero Gate Voltage Drain Leakage Current ($V_{DS} = 65\text{ Vdc}$, $V_{GS} = 0\text{ Vdc}$)	I_{DSS}	—	—	10	μA
Zero Gate Voltage Drain Leakage Current ($V_{DS} = 28\text{ Vdc}$, $V_{GS} = 0\text{ Vdc}$)	I_{DSS}	—	—	1	μA
Gate-Source Leakage Current ($V_{GS} = 5\text{ Vdc}$, $V_{DS} = 0\text{ Vdc}$)	I_{GSS}	—	—	1	μA

On Characteristics

Gate Threshold Voltage ($V_{DS} = 10\text{ Vdc}$, $I_D = 316\ \mu\text{A}$)	$V_{GS(th)}$	1.2	1.9	2.7	Vdc
Gate Quiescent Voltage ($V_{DS} = 28\text{ Vdc}$, $I_D = 1100\text{ mA}$)	$V_{GS(Q)}$	—	2.7	—	Vdc
Fixture Gate Quiescent Voltage (1) ($V_{DD} = 28\text{ Vdc}$, $I_D = 1100\text{ mA}$, Measured in Functional Test)	$V_{GG(Q)}$	4	5.3	7	Vdc
Drain-Source On-Voltage ($V_{GS} = 10\text{ Vdc}$, $I_D = 3.16\text{ A}$)	$V_{DS(on)}$	0.1	0.2	0.3	Vdc

Dynamic Characteristics (2)

Reverse Transfer Capacitance ($V_{DS} = 28\text{ Vdc} \pm 30\text{ mV(rms)}$ ac @ 1 MHz, $V_{GS} = 0\text{ Vdc}$)	C_{rss}	—	1.15	—	pF
Output Capacitance ($V_{DD} = 28\text{ Vdc} \pm 30\text{ mV(rms)}$ ac @ 1 MHz, $V_{GS} = 0\text{ Vdc}$)	C_{oss}	—	675	—	pF
Input Capacitance ($V_{DS} = 28\text{ Vdc}$, $V_{GS} = 0\text{ Vdc} \pm 30\text{ mV(rms)}$ ac @ 1 MHz)	C_{iss}	—	312	—	pF

Functional Tests (In Freescale Test Fixture, 50 ohm system) $V_{DD} = 28\text{ Vdc}$, $I_{DQ} = 1100\text{ mA}$, $P_{out} = 125\text{ W CW}$, $f = 1880\text{ MHz}$

Power Gain	G_{ps}	15.5	17	18.5	dB
Drain Efficiency	η_D	51	55	—	%
Input Return Loss	IRL	—	-12	-6	dB

- $V_{GG} = 2 \times V_{GS(Q)}$. Parameter measured on Freescale Test Fixture, due to resistive divider network on the board. Refer to Test Circuit schematic.
- Part internally matched both on input and output.

(continued)

Table 4. Electrical Characteristics ($T_C = 25^\circ\text{C}$ unless otherwise noted) (continued)

Characteristic	Symbol	Min	Typ	Max	Unit
Typical Performances (In Freescale Test Fixture, 50 ohm system) $V_{DD} = 28\text{ Vdc}$, $I_{DQ} = 1100\text{ mA}$, 1805-1880 MHz Bandwidth					
P_{out} @ 1 dB Compression Point	P_{1dB}	—	140	—	W
IMD Symmetry @ 125 W PEP, P_{out} where IMD Third Order Intermodulation $\cong 30\text{ dBc}$ (Delta IMD Third Order Intermodulation between Upper and Lower Sidebands $> 2\text{ dB}$)	IMD_{sym}	—	8	—	MHz
VBW Resonance Point (IMD Third Order Intermodulation Inflection Point)	VBW_{res}	—	35	—	MHz
Gain Flatness in 75 MHz Bandwidth @ $P_{out} = 125\text{ W CW}$	G_F	—	0.8	—	dB
Average Deviation from Linear Phase in 75 MHz Bandwidth @ $P_{out} = 125\text{ W CW}$	Φ	—	0.49	—	$^\circ$
Average Group Delay @ $P_{out} = 125\text{ W CW}$, $f = 1840\text{ MHz}$	Delay	—	1.21	—	ns
Part-to-Part Insertion Phase Variation @ $P_{out} = 125\text{ W CW}$, $f = 1840\text{ MHz}$, Six Sigma Window	$\Delta\Phi$	—	8.66	—	$^\circ$
Gain Variation over Temperature (-30°C to $+85^\circ\text{C}$)	ΔG	—	0.016	—	dB/ $^\circ\text{C}$
Output Power Variation over Temperature (-30°C to $+85^\circ\text{C}$)	ΔP_{1dB}	—	0.01	—	dBm/ $^\circ\text{C}$

Typical GSM EDGE Performances (In Freescale GSM EDGE Test Fixture, 50 ohm system) $V_{DD} = 28\text{ Vdc}$, $I_{DQ} = 1100\text{ mA}$, $P_{out} = 57\text{ W}$ Avg., 1805-1880 MHz EDGE Modulation

Power Gain	G_{ps}	—	17	—	dB
Drain Efficiency	η_D	—	38	—	%
Error Vector Magnitude	EVM	—	1.75	—	% rms
Spectral Regrowth at 400 kHz Offset	SR1	—	-63	—	dBc
Spectral Regrowth at 600 kHz Offset	SR2	—	-75	—	dBc

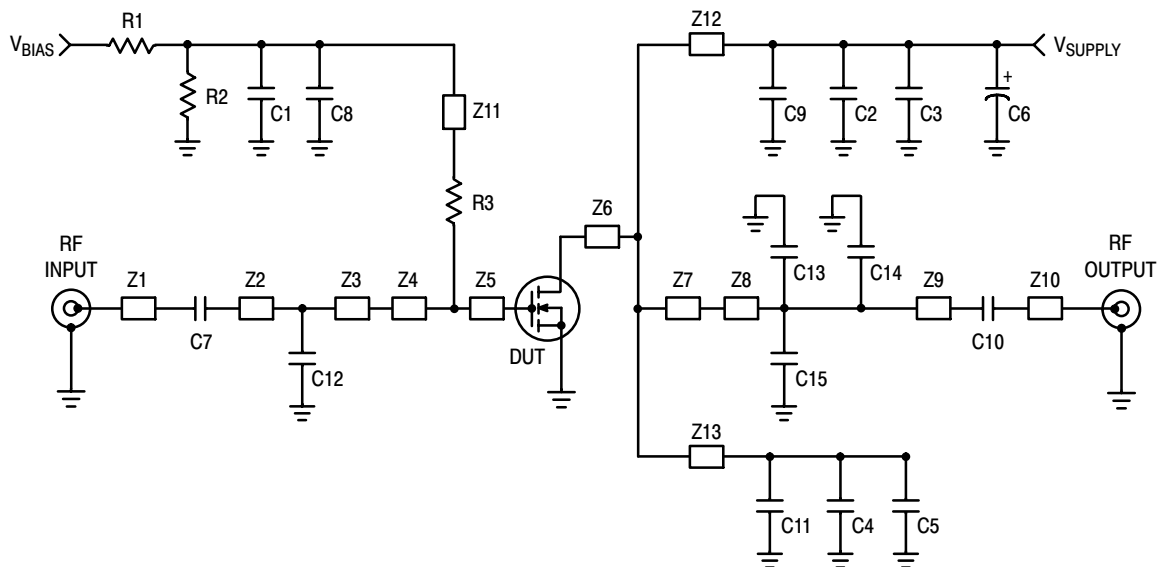

Z1	0.227" x 0.083" Microstrip	Z8	0.200" x 0.083" Microstrip
Z2	1.180" x 0.083" Microstrip	Z9	1.116" x 0.083" Microstrip
Z3	0.135" x 0.083" Microstrip	Z10	0.227" x 0.083" Microstrip
Z4	0.568" x 1.000" Microstrip	Z11	1.175" x 0.080" Microstrip
Z5	0.092" x 1.000" Microstrip	Z12, Z13	0.760" x 0.080" Microstrip
Z6	0.095" x 1.000" Microstrip	PCB	Taconic TLX-8 RF35, 0.031", $\epsilon_r = 2.55$
Z7	0.565" x 1.000" Microstrip		

Figure 1. MRF7S18125AHR3(HSR3) Test Circuit Schematic

Table 5. MRF7S18125AHR3(HSR3) Test Circuit Component Designations and Values

Part	Description	Part Number	Manufacturer
C1	1 μ F, 50 V Chip Capacitor	C3216X5R1H105K	TDK
C2, C3, C4, C5	4.7 μ F, 50 V Chip Capacitors	C4532X5R1H475M	TDK
C6	220 μ F, 63 V Electrolytic Chip Capacitor	2222 136 68221	Vishay
C7, C8, C9, C10, C11	8.2 pF Chip Capacitors	ATC100B8R2BT500XT	ATC
C12, C13, C14	0.2 pF Chip Capacitors	ATC100B0R2BT500XT	ATC
C15	0.5 pF Chip Capacitor	ATC100B0R5BT500XT	ATC
R1, R2	10 k Ω , 1/4 W Chip Resistors	CRCW12061001FKFA	Vishay
R3	10 Ω , 1/4 W Chip Resistor	CRCW120610R0FKFA	Vishay

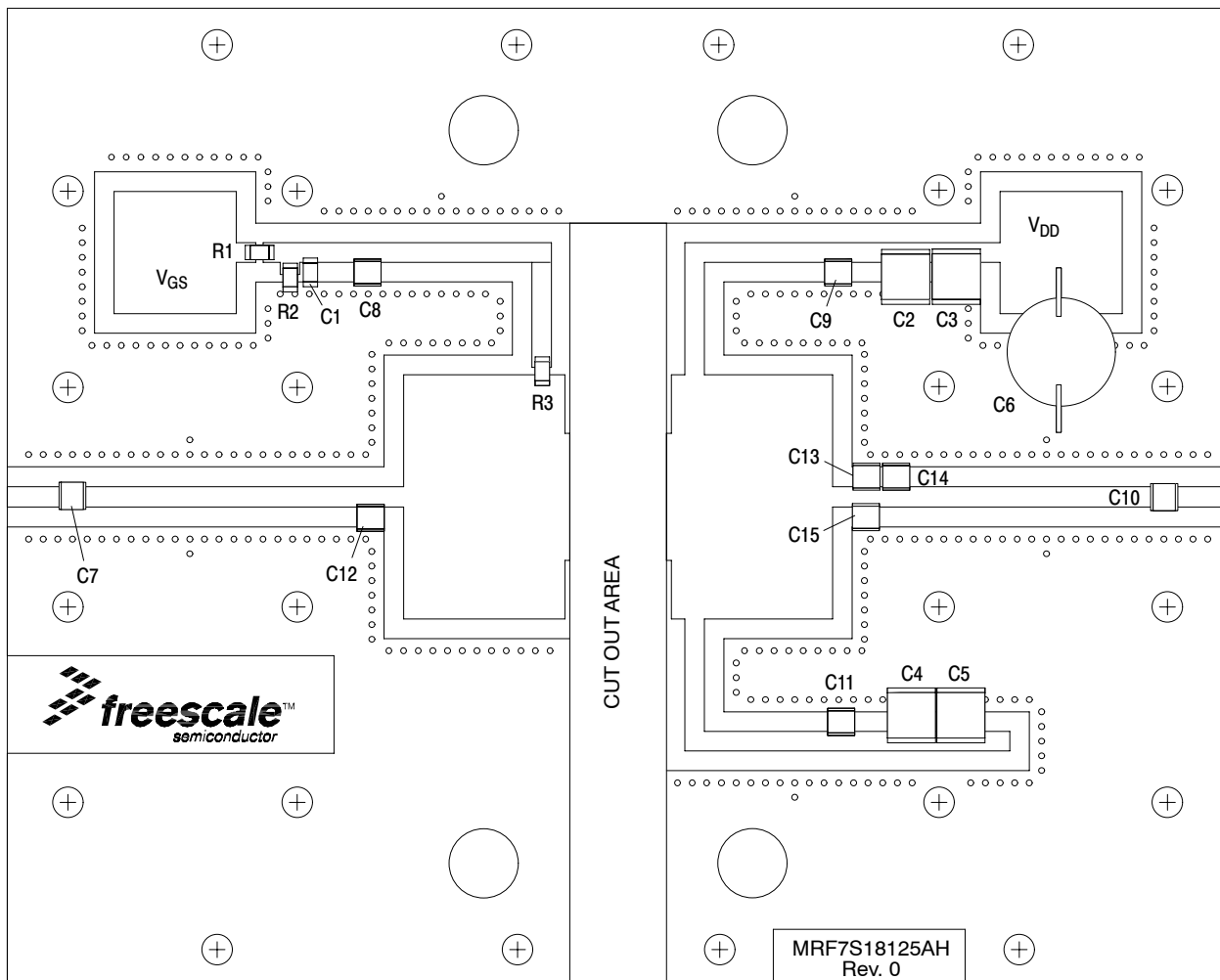

Figure 2. MRF7S18125AHR3(HSR3) Test Circuit Component Layout

TYPICAL CHARACTERISTICS

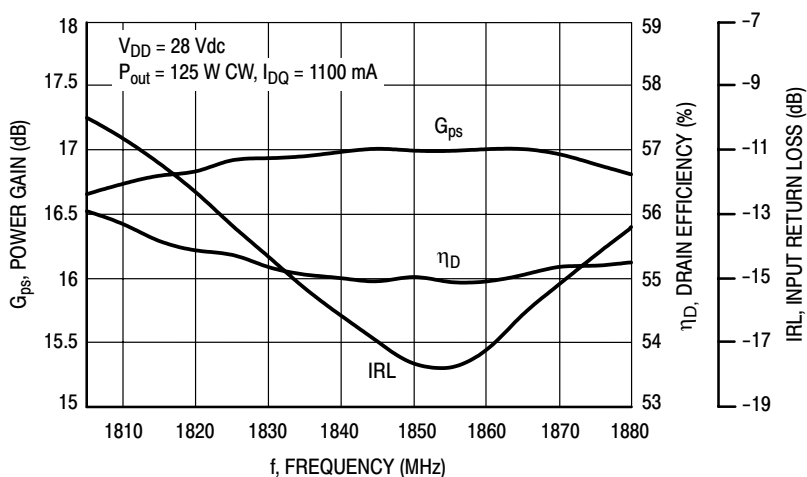

Figure 3. Power Gain, Input Return Loss and Drain Efficiency versus Frequency @ $P_{out} = 125$ Watts CW

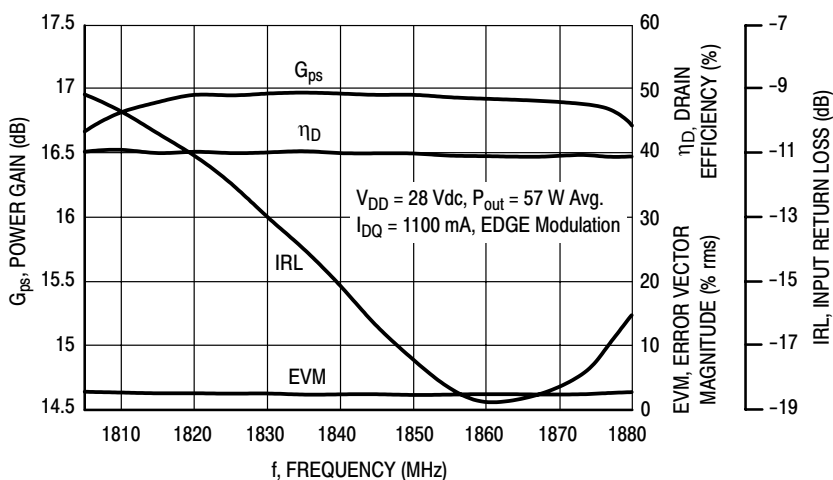

Figure 4. Power Gain, Input Return Loss, EVM and Drain Efficiency versus Frequency @ $P_{out} = 57$ Watts Avg.

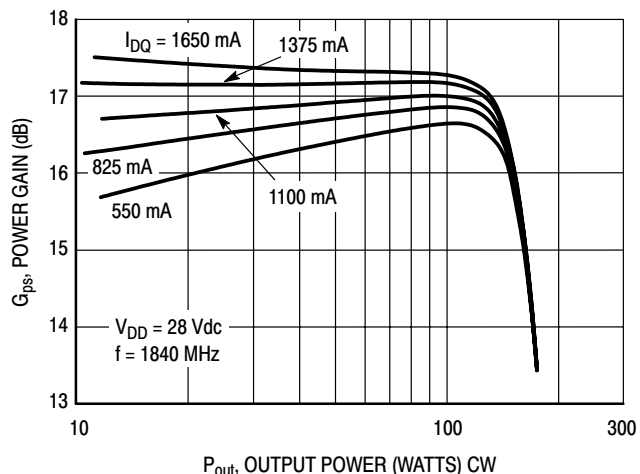

Figure 5. Power Gain versus Output Power

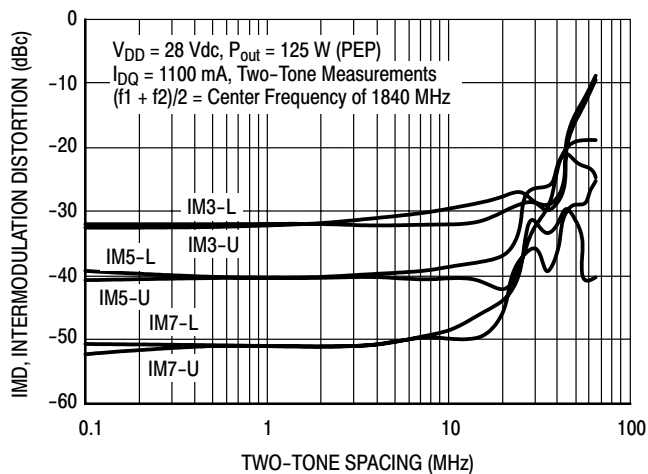

Figure 6. Intermodulation Distortion Products versus Two-Tone Spacing

TYPICAL CHARACTERISTICS

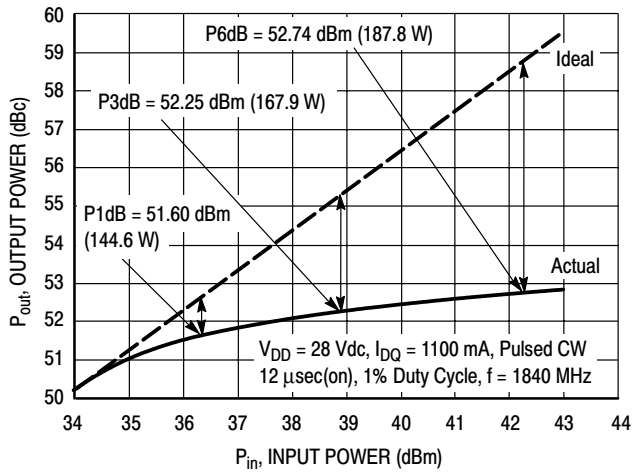

Figure 7. Pulsed CW Output Power versus Input Power

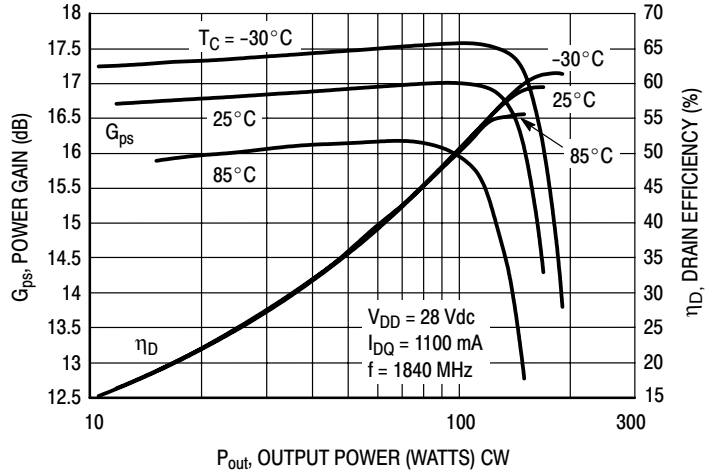

Figure 8. Power Gain and Drain Efficiency versus Output Power

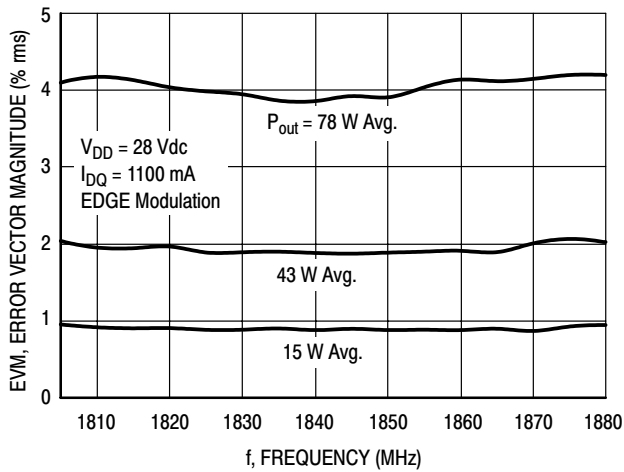

Figure 9. EVM versus Frequency

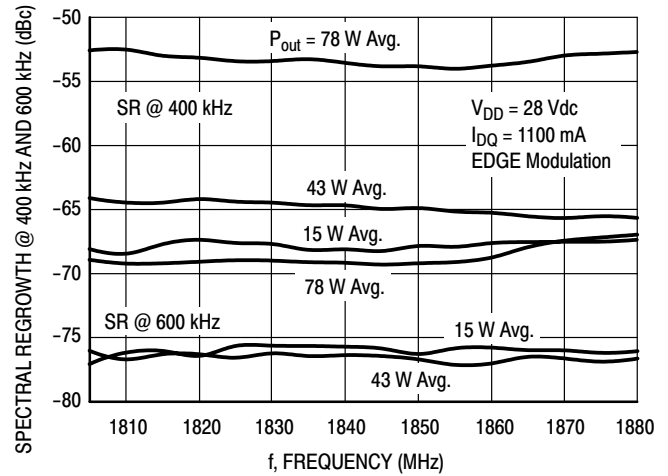

Figure 10. Spectral Regrowth at 400 kHz and 600 kHz versus Frequency

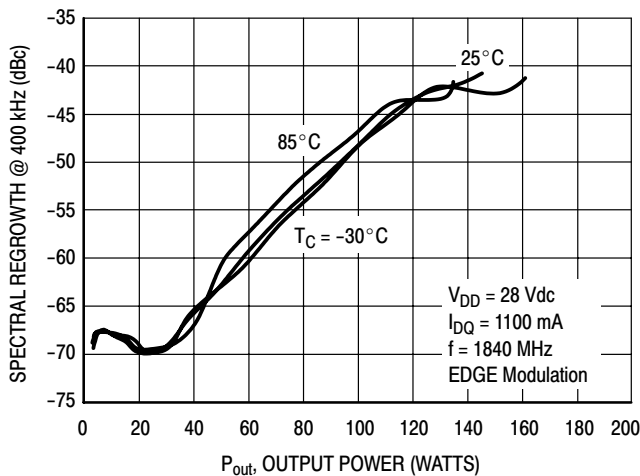

Figure 11. Spectral Regrowth at 400 kHz versus Output Power

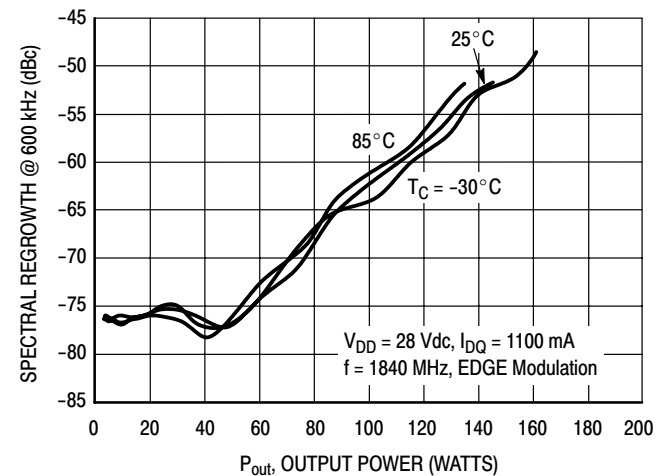

Figure 12. Spectral Regrowth at 600 kHz versus Output Power

TYPICAL CHARACTERISTICS

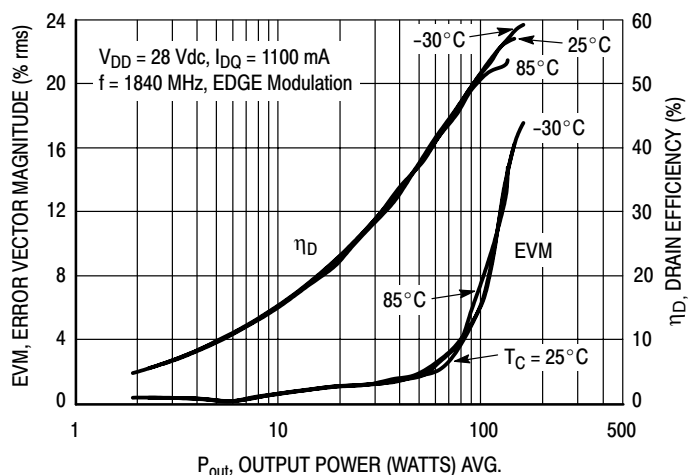

Figure 13. EVM and Drain Efficiency versus Output Power

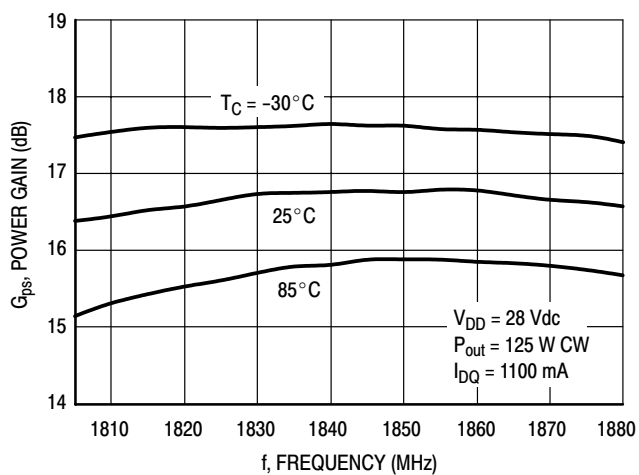
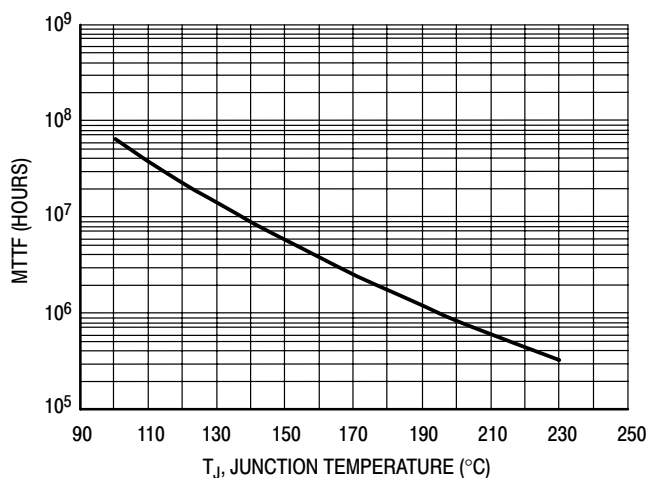

Figure 14. Power Gain versus Frequency



This above graph displays calculated MTTF in hours when the device is operated at $V_{DD} = 28 \text{ Vdc}$, $P_{out} = 125 \text{ W CW}$, and $\eta_D = 55\%$.

MTTF calculator available at <http://www.freescale.com/rf>. Select Software & Tools/Development Tools/Calculators to access MTTF calculators by product.

Figure 15. MTTF versus Junction Temperature

GSM TEST SIGNAL

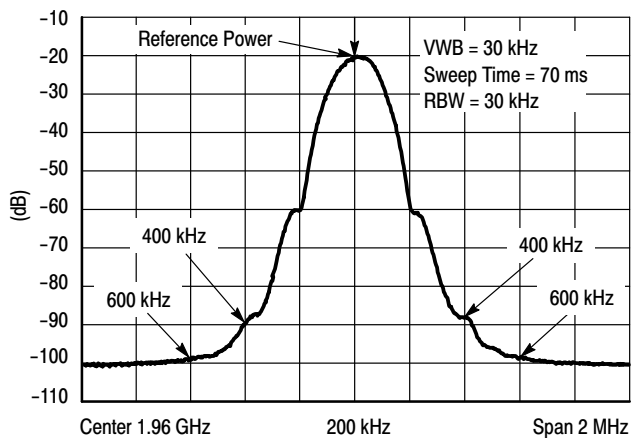
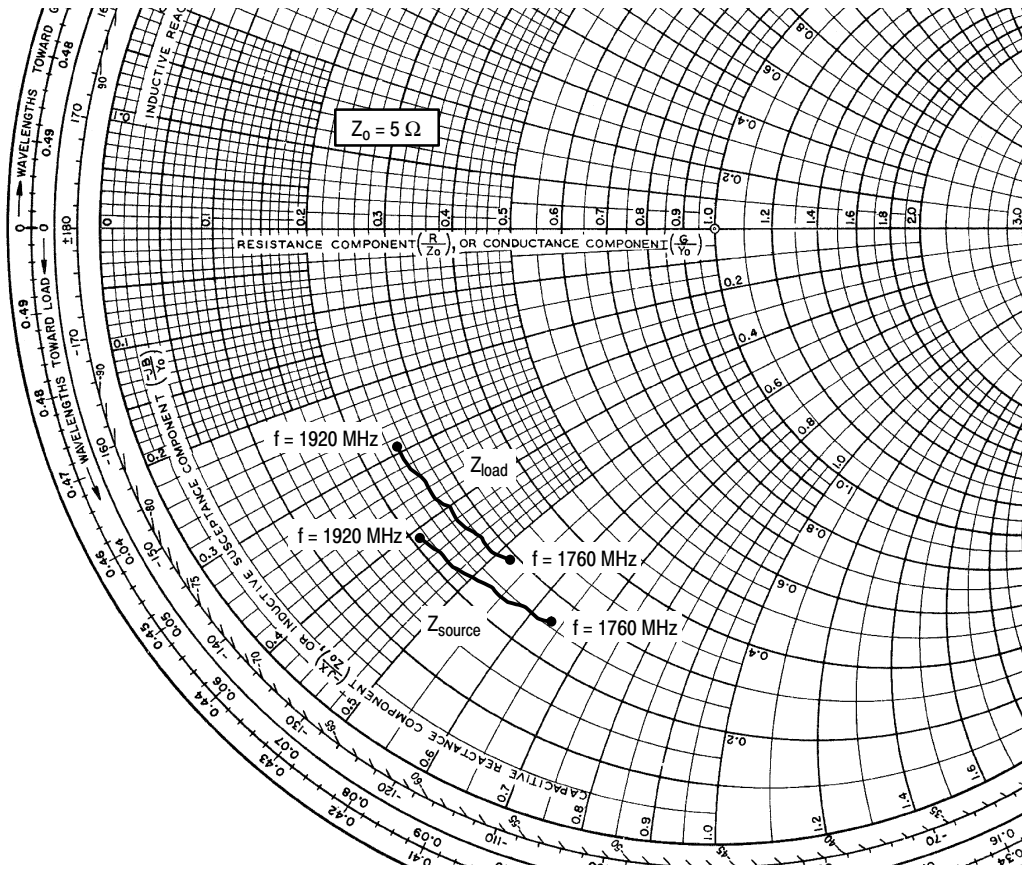

Figure 16. EDGE Spectrum



$V_{DD} = 28 \text{ Vdc}$, $I_{DQ} = 1100 \text{ mA}$, $P_{out} = 125 \text{ W CW}$

f MHz	Z_{source} Ω	Z_{load} Ω
1760	$1.30 - j3.17$	$1.44 - j2.62$
1780	$1.27 - j3.05$	$1.41 - j2.47$
1800	$1.24 - j2.92$	$1.39 - j2.32$
1820	$1.21 - j2.80$	$1.37 - j2.17$
1840	$1.18 - j2.66$	$1.34 - j2.02$
1860	$1.15 - j2.52$	$1.31 - j1.88$
1880	$1.12 - j2.37$	$1.29 - j1.73$
1900	$1.09 - j2.21$	$1.26 - j1.58$
1920	$1.05 - j2.06$	$1.23 - j1.44$

Z_{source} = Test circuit impedance as measured from gate to ground.

Z_{load} = Test circuit impedance as measured from drain to ground.

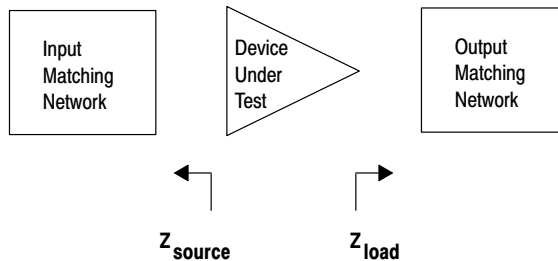
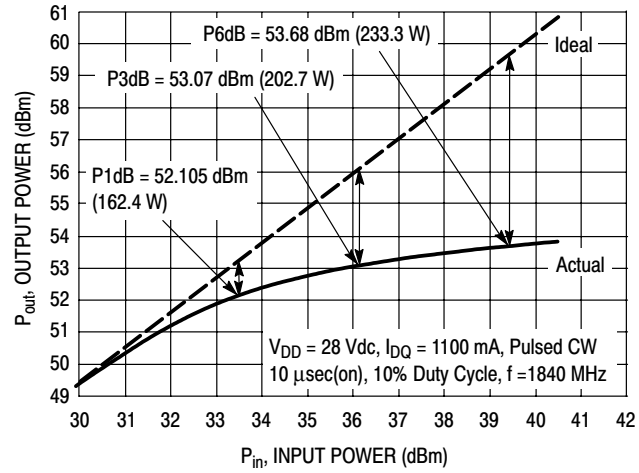

Figure 17. Series Equivalent Source and Load Impedance

ALTERNATIVE PEAK TUNE LOAD PULL CHARACTERISTICS



NOTE: Load Pull Test Fixture Tuned for Peak P1dB Output Power @ 28 V

Test Impedances per Compression Level

	Z_{source} Ω	Z_{load} Ω
P1dB	$0.60 - j2.81$	$1.05 - j2.36$

Figure 18. Pulsed CW Output Power versus Input Power @ 28 V

PACKAGE DIMENSIONS

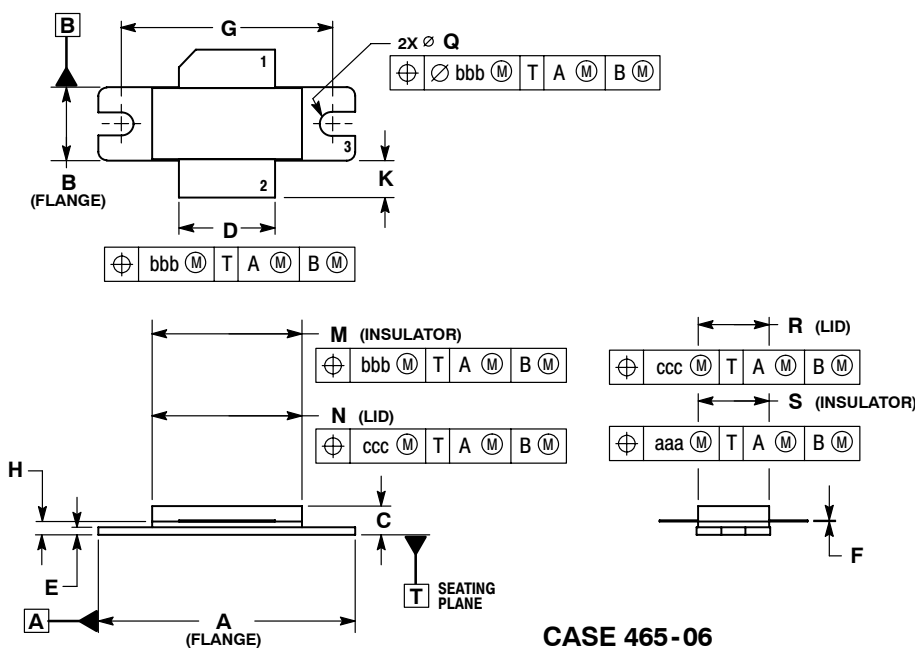

- NOTES:
1. DIMENSIONING AND TOLERANCING PER ANSI Y14.5M-1994.
 2. CONTROLLING DIMENSION: INCH.
 3. DELETED
 4. DIMENSION H IS MEASURED 0.030 (0.762) AWAY FROM PACKAGE BODY.

DIM	INCHES		MILLIMETERS	
	MIN	MAX	MIN	MAX
A	1.335	1.345	33.91	34.16
B	0.380	0.390	9.65	9.91
C	0.125	0.170	3.18	4.32
D	0.495	0.505	12.57	12.83
E	0.035	0.045	0.89	1.14
F	0.003	0.006	0.08	0.15
G	1.100 BSC		27.94 BSC	
H	0.057	0.067	1.45	1.70
K	0.170	0.210	4.32	5.33
M	0.774	0.786	19.66	19.96
N	0.772	0.788	19.60	20.00
Q	\varnothing 1.18	\varnothing 1.38	\varnothing 3.00	\varnothing 3.51
R	0.365	0.375	9.27	9.53
S	0.365	0.375	9.27	9.52
aaa	0.005 REF		0.127 REF	
bbb	0.010 REF		0.254 REF	
ccc	0.015 REF		0.381 REF	

- STYLE 1:
 PIN 1. DRAIN
 2. GATE
 3. SOURCE

**CASE 465-06
 ISSUE G
 NI-780
 MRF7S18125AHR3**

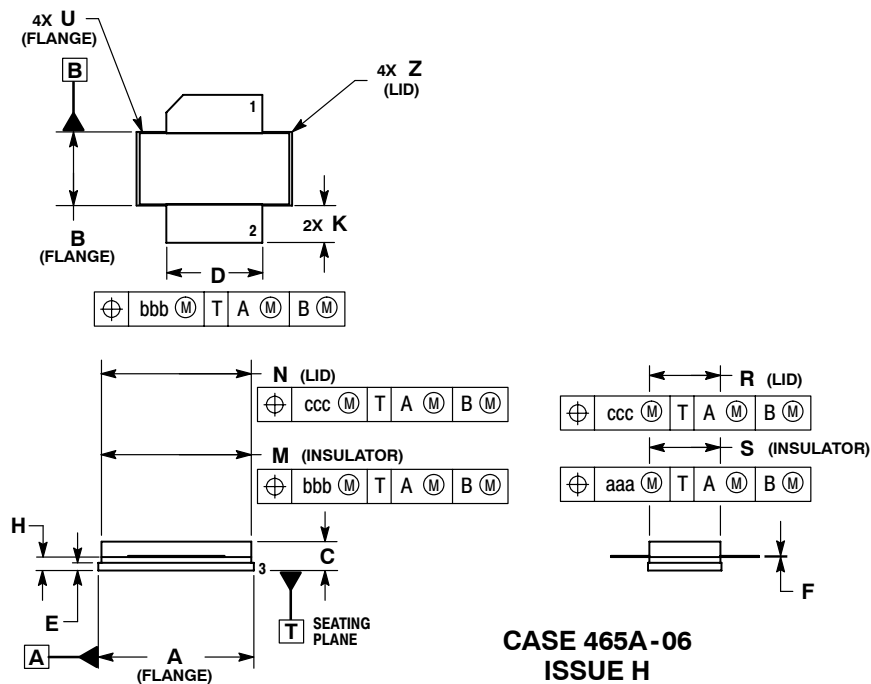

- NOTES:
1. DIMENSIONING AND TOLERANCING PER ANSI Y14.5M-1994.
 2. CONTROLLING DIMENSION: INCH.
 3. DELETED
 4. DIMENSION H IS MEASURED 0.030 (0.762) AWAY FROM PACKAGE BODY.

DIM	INCHES		MILLIMETERS	
	MIN	MAX	MIN	MAX
A	0.805	0.815	20.45	20.70
B	0.380	0.390	9.65	9.91
C	0.125	0.170	3.18	4.32
D	0.495	0.505	12.57	12.83
E	0.035	0.045	0.89	1.14
F	0.003	0.006	0.08	0.15
H	0.057	0.067	1.45	1.70
K	0.170	0.210	4.32	5.33
M	0.774	0.786	19.61	20.02
N	0.772	0.788	19.61	20.02
R	0.365	0.375	9.27	9.53
S	0.365	0.375	9.27	9.52
U	---	0.040	---	1.02
Z	---	0.030	---	0.76
aaa	0.005 REF		0.127 REF	
bbb	0.010 REF		0.254 REF	
ccc	0.015 REF		0.381 REF	

- STYLE 1:
 PIN 1. DRAIN
 2. GATE
 5. SOURCE

**CASE 465A-06
 ISSUE H
 NI-780S
 MRF7S18125AHSR3**

PRODUCT DOCUMENTATION

Refer to the following documents to aid your design process.

Application Notes

- AN1955: Thermal Measurement Methodology of RF Power Amplifiers

Engineering Bulletins

- EB212: Using Data Sheet Impedances for RF LDMOS Devices

REVISION HISTORY

The following table summarizes revisions to this document.

Revision	Date	Description
0	Nov. 2008	<ul style="list-style-type: none"> • Initial Release of Data Sheet

How to Reach Us:

Home Page:

www.freescale.com

Web Support:

<http://www.freescale.com/support>

USA/Europe or Locations Not Listed:

Freescale Semiconductor, Inc.
Technical Information Center, EL516
2100 East Elliot Road
Tempe, Arizona 85284
1-800-521-6274 or +1-480-768-2130
www.freescale.com/support

Europe, Middle East, and Africa:

Freescale Halbleiter Deutschland GmbH
Technical Information Center
Schatzbogen 7
81829 Muenchen, Germany
+44 1296 380 456 (English)
+46 8 52200080 (English)
+49 89 92103 559 (German)
+33 1 69 35 48 48 (French)
www.freescale.com/support

Japan:

Freescale Semiconductor Japan Ltd.
Headquarters
ARCO Tower 15F
1-8-1, Shimo-Meguro, Meguro-ku,
Tokyo 153-0064
Japan
0120 191014 or +81 3 5437 9125
support.japan@freescale.com

Asia/Pacific:

Freescale Semiconductor China Ltd.
Exchange Building 23F
No. 118 Jianguo Road
Chaoyang District
Beijing 100022
China
+86 10 5879 8000
support.asia@freescale.com

For Literature Requests Only:

Freescale Semiconductor Literature Distribution Center
P.O. Box 5405
Denver, Colorado 80217
1-800-441-2447 or +1-303-675-2140
Fax: +1-303-675-2150
LDCForFreescaleSemiconductor@hibbertgroup.com

Information in this document is provided solely to enable system and software implementers to use Freescale Semiconductor products. There are no express or implied copyright licenses granted hereunder to design or fabricate any integrated circuits or integrated circuits based on the information in this document.

Freescale Semiconductor reserves the right to make changes without further notice to any products herein. Freescale Semiconductor makes no warranty, representation or guarantee regarding the suitability of its products for any particular purpose, nor does Freescale Semiconductor assume any liability arising out of the application or use of any product or circuit, and specifically disclaims any and all liability, including without limitation consequential or incidental damages. "Typical" parameters that may be provided in Freescale Semiconductor data sheets and/or specifications can and do vary in different applications and actual performance may vary over time. All operating parameters, including "Typicals", must be validated for each customer application by customer's technical experts. Freescale Semiconductor does not convey any license under its patent rights nor the rights of others. Freescale Semiconductor products are not designed, intended, or authorized for use as components in systems intended for surgical implant into the body, or other applications intended to support or sustain life, or for any other application in which the failure of the Freescale Semiconductor product could create a situation where personal injury or death may occur. Should Buyer purchase or use Freescale Semiconductor products for any such unintended or unauthorized application, Buyer shall indemnify and hold Freescale Semiconductor and its officers, employees, subsidiaries, affiliates, and distributors harmless against all claims, costs, damages, and expenses, and reasonable attorney fees arising out of, directly or indirectly, any claim of personal injury or death associated with such unintended or unauthorized use, even if such claim alleges that Freescale Semiconductor was negligent regarding the design or manufacture of the part.

Freescale™ and the Freescale logo are trademarks of Freescale Semiconductor, Inc. All other product or service names are the property of their respective owners.

© Freescale Semiconductor, Inc. 2008. All rights reserved.

Looking for pricing, stock, or lifecycle information?

Click below to explore more details on WIN SOURCE:

 [View MRF7S18125AHSR3 on WIN SOURCE](#)

 [NXP / Nexperia Information](#)

Optimize Your Supply Chain with WIN SOURCE Solutions

-  Global Sourcing Solution
-  Obsolete Management
-  Cost Control Management
-  Shortage Management
-  Alternative Solution
-  Excess Inventory Management