



**THE DATASHEET OF  
MTE1S2405MC**





### FEATURES

- Single isolated output
- 1kVDC isolation “Hi Pot Test”
- Typical efficiency 86%
- Wide temperature performance at full 1 Watt load, -40°C to 85°C
- UL 60950 recognised
- 3.3V, 5V, 12V & 24V inputs
- 5V output
- Internal SMD construction
- Toroidal magnetics

### PRODUCT OVERVIEW

The MTE1 series is a new range of surface mount, high performance 1W DC-DC converters. The MTE1 series is the new high performance version of our 1W NTE series, the MTE1 series is more efficient and offers improved regulation performance. The MTE1 series offers 1W of available output power over the full industrial temperature range of -40°C to 85°C.

The MTE1 series has a MSL rating 1, and is compatible with a peak reflow solder temperature of 245°C as per J-STD-020D.1.

### SELECTION GUIDE

| Order Code <sup>1</sup>                 | Nominal Input Voltage | Output Voltage | Output Current | Input Current at Rated Load (Typ.) | Load Regulation (Typ.) | Load Regulation (Max) | Output Ripple & Noise (Typ.) | Efficiency (Min.) | Efficiency (Typ.) | Isolation Capacitance | MTTF <sup>2</sup> | Recommended Alternative |
|---|-----------------------|----------------|----------------|------------------------------------|------------------------|-----------------------|------------------------------|-------------------|-------------------|-----------------------|-------------------|-------------------------|
|   | V                     | V              | mA             | mA                                 | %                      | %                     | mVp-p                        | %                 | %                 | pF                    | kHrs              |                         |
| <b>Recommended</b> <b>In Production</b> |                       |                |                |                                    |                        |                       |                              |                   |                   |                       |                   |                         |
| MTE1S0305MC                             | 3.3                   | 5              | 200            | 363                                | 8.5                    | 11                    | 24                           | 79                | 82                | 16                    | 2912              |                         |
| MTE1S0505MC                             | 5                     | 5              | 200            | 239                                | 6.5                    | 8                     | 20                           | 79                | 82                | 22                    | 3041              |                         |
| MTE1S0506MC                             | 5                     | 6              | 167            | 236                                | 6                      | 7.5                   | 20                           | 81                | 84                | 24                    | 3024              |                         |
| MTE1S1205MC                             | 12                    | 5              | 200            | 97                                 | 5                      | 7                     | 19                           | 81                | 84                | 24                    | 2707              |                         |
| MTE1S2405MC                             | 24                    | 5              | 200            | 50                                 | 4                      | 5.5                   | 20                           | 79                | 83                | 21                    | 2731              |                         |
| <b>Discontinued</b>                     |                       |                |                |                                    |                        |                       |                              |                   |                   |                       |                   |                         |
| MTE1S0303MC                             | 3.3                   | 3.3            | 303            | 382                                | 11                     | 13.5                  | 33                           | 75                | 78                | 15                    | 3083              | NXE1S0303MC-R7          |
| MTE1S0309MC                             | 3.3                   | 9              | 111            | 353                                | 7                      | 9                     | 17                           | 82                | 85                | 21                    | 2759              | NTE0309MC               |
| MTE1S0312MC                             | 3.3                   | 12             | 83             | 348                                | 6.5                    | 8                     | 15                           | 83                | 86                | 20                    | 2573              | Contact Murata          |
| MTE1S0315MC                             | 3.3                   | 15             | 67             | 346                                | 6                      | 8                     | 13                           | 83                | 86                | 20                    | 2265              | Contact Murata          |
| MTE1S0503MC                             | 5                     | 3.3            | 303            | 248                                | 9                      | 12                    | 24                           | 77                | 79                | 21                    | 3080              | NTE0503MC               |
| MTE1S0509MC                             | 5                     | 9              | 111            | 233                                | 5                      | 6.5                   | 15                           | 83                | 85                | 26                    | 2875              | NTE0509MC               |
| MTE1S0512MC                             | 5                     | 12             | 83             | 227                                | 5                      | 6.5                   | 14                           | 84                | 87                | 29                    | 2658              | NTE0512MC               |
| MTE1S0515MC                             | 5                     | 15             | 67             | 225                                | 5                      | 6.5                   | 11                           | 85                | 88                | 33                    | 2336              | NTE0515MC               |
| MTE1S1209MC                             | 12                    | 9              | 111            | 95                                 | 3                      | 4.5                   | 13                           | 82                | 86                | 29                    | 2597              | NTE1209MC               |
| MTE1S1212MC                             | 12                    | 12             | 83             | 93                                 | 3                      | 4.5                   | 12                           | 85                | 88                | 43                    | 2422              | NTE1212MC               |
| MTE1S1215MC                             | 12                    | 15             | 67             | 93                                 | 3                      | 4                     | 11                           | 85                | 88                | 40                    | 2169              | NTE1215MC               |
| MTE1S1505MC                             | 15                    | 5              | 200            | 79                                 | 4                      | 5.5                   | 15                           | 80                | 83                | 25                    | 2444              | Contact Murata          |
| MTE1S1509MC                             | 15                    | 9              | 111            | 77                                 | 3                      | 4                     | 9                            | 81                | 86                | 38                    | 2366              | Contact Murata          |
| MTE1S1512MC                             | 15                    | 12             | 83             | 76                                 | 2.5                    | 4                     | 10                           | 82                | 87                | 45                    | 2196              | Contact Murata          |
| MTE1S1515MC                             | 15                    | 15             | 67             | 75                                 | 2.5                    | 4                     | 8                            | 84                | 88                | 57                    | 2001              | Contact Murata          |
| MTE1S2409MC                             | 24                    | 9              | 111            | 48                                 | 2.5                    | 4                     | 19                           | 84                | 86                | 31                    | 2698              | Contact Murata          |
| MTE1S2412MC                             | 24                    | 12             | 83             | 48                                 | 2                      | 3.5                   | 19                           | 83                | 87                | 39                    | 2488              | Contact Murata          |
| MTE1S2415MC                             | 24                    | 15             | 67             | 48                                 | 2                      | 3.5                   | 22                           | 85                | 88                | 46                    | 2392              | NXJ2S2415MC-R7          |

### INPUT CHARACTERISTICS

| Parameter                | Conditions                             | Min. | Typ. | Max. | Units  |
|--------------------------|--|------|------|------|--------|
| Voltage range            | Continuous operation, 3.3V input types | 2.97 | 3.3  | 3.63 | V      |
|                          | Continuous operation, 5V input types   | 4.5  | 5.0  | 5.5  |        |
|                          | Continuous operation, 12V input types  | 10.8 | 12.0 | 13.2 |        |
|                          | Continuous operation, 15V input types  | 13.5 | 15.0 | 16.5 |        |
|                          | Continuous operation, 24V input types  | 21.6 | 24   | 26.4 |        |
| Reflected ripple current |  |      | 5    | 15   | mA p-p |

### GENERAL CHARACTERISTICS

| Parameter           | Conditions       | Min. | Typ. | Max. | Units |
|---------------------|------------------|------|------|------|-------|
| Switching frequency | All output types |      | 80   |      | Hz    |

### OUTPUT CHARACTERISTICS

| Parameter                  | Conditions                                  | Min. | Typ. | Max. | Units  |
|----------------------------|---|------|------|------|--------|
| Rated power                | T <sub>A</sub> = -40°C to 85°C              |      |      | 1.0  | W      |
| Voltage set point accuracy | See tolerance envelope                      |      |      |      |        |
| Line regulation            | High V <sub>IN</sub> to low V <sub>IN</sub> |      | 1.1  | 1.2  | %/%    |
| Ripple and noise           | BW=DC to 20MHz                              |      | 25   | 70   | mV p-p |



1. If components are required in tape and reel format suffix order code with -R, e.g. MTE0505MC-R.  
 2. Calculated using MIL-HDBK-217 FN2 calculation model with nominal input voltage at full load.  
 All specifications typical at T<sub>A</sub>=25°C, nominal input voltage and rated output current unless otherwise specified.

| ISOLATION CHARACTERISTICS |                           |      |      |      |       |
|---------------------------|---------------------------|------|------|------|-------|
| Parameter                 | Conditions                | Min. | Typ. | Max. | Units |
| Isolation voltage         | Flash tested for 1 second | 1000 |      |      | VDC   |
| Resistance                | Viso= 1000VDC             | 20   |      |      | GΩ    |

| TEMPERATURE CHARACTERISTICS         |                     |      |      |      |       |
|-------------------------------------|---------------------|------|------|------|-------|
| Parameter                           | Conditions          | Min. | Typ. | Max. | Units |
| Specification                       | All output types    | -40  |      | 85   | °C    |
| Storage                             |                     | -50  |      | 130  |       |
| Case temperature rise above ambient | All output types    |      | 12.5 | 20   |       |
| Cooling                             | Free air convection |      |      |      |       |

| ABSOLUTE MAXIMUM RATINGS             |      |
|--------------------------------------|------|
| Input voltage $V_{IN}$ , MTE03 types | 5.5V |
| Input voltage $V_{IN}$ , MTE05 types | 7V   |
| Input voltage $V_{IN}$ , MTE12 types | 15V  |
| Input voltage $V_{IN}$ , MTE15 types | 18V  |
| Input voltage $V_{IN}$ , MTE24 types | 28V  |

**TECHNICAL NOTES**

**ISOLATION VOLTAGE**

'Hi Pot Test', 'Flash Tested', 'Withstand Voltage', 'Proof Voltage', 'Dielectric Withstand Voltage' & 'Isolation Test Voltage' are all terms that relate to the same thing, a test voltage, applied for a specified time, across a component designed to provide electrical isolation, to verify the integrity of that isolation.

Murata Power Solutions MTE1 series of DC-DC converters are all 100% production tested at their stated isolation voltage. This is 1kVDC for 1 second.

A question commonly asked is, "What is the continuous voltage that can be applied across the part in normal operation?"

The MTE1 has been recognised by Underwriters Laboratory for functional insulation, both input and output should normally be maintained within SELV limits i.e. less than 42.4V peak, or 60VDC. The isolation test voltage represents a measure of immunity to transient voltages and the part should never be used as an element of a safety isolation system. The part could be expected to function correctly with several hundred volts offset applied continuously across the isolation barrier; but then the circuitry on both sides of the barrier must be regarded as operating at an unsafe voltage and further isolation/insulation systems must form a barrier between these circuits and any user-accessible circuitry according to safety standard requirements.

**REPEATED HIGH-VOLTAGE ISOLATION TESTING**

It is well known that repeated high-voltage isolation testing of a barrier component can actually degrade isolation capability, to a lesser or greater degree depending on materials, construction and environment. The MTE1 series has toroidal isolation transformers, with no additional insulation between primary and secondary windings of enamelled wire. While parts can be expected to withstand several times the stated test voltage, the isolation capability does depend on the wire insulation. Any material, including this enamel (typically polyurethane) is susceptible to eventual chemical degradation when subject to very high applied voltages thus implying that the number of tests should be strictly limited. We therefore strongly advise against repeated high voltage isolation testing, but if it is absolutely required, that the voltage be reduced by 20% from specified test voltage.

This consideration equally applies to agency recognised parts rated for better than functional isolation where the wire enamel insulation is always supplemented by a further insulation system of physical spacing or barriers.

**SAFETY APPROVAL**

The MTE1 series has been recognised by Underwriters Laboratory (UL) to UL 60950 for functional insulation in a maximum ambient temperature for 3.3V & 5V input models of 60°C and for 12V, 15V and 24V models of 85°C. File number E151252 applies. The MTE1 Series of converters are not internally fused so to meet the requirements of UL 60950 an anti-surge input line fuse should always be used with ratings as defined below.

- MTE1S03xxxC: 1A
- MTE1S05xxxC: 0.7A
- MTE1S12xxxC: 0.2A
- MTE1S15xxxC: 0.2A
- MTE1S24xxxC: 0.16A

All fuses should be UL approved and rated to at least the maximum allowable DC input voltage.

**RoHS COMPLIANCE, MSL AND PSL INFORMATION**



This series is compatible with RoHS soldering systems as per J-STD-020D.1. Please refer to [application notes](#) for further information. The pin termination finish on this product series is Matte Tin over Nickel Preplate. The series is backward compatible with Sn/Pb soldering systems. The series has a Moisture Sensitivity Level (MSL) 1.

Samples of the product series were tested in accordance with the conditioning described for MSL level 1 in IDC/J-STD-020D.1. The product series passed electrical tests and visual inspection criteria.

For further information, please visit: [www.murata.com/en-global/products/power/rohs](http://www.murata.com/en-global/products/power/rohs)

**TEMPERATURE DERATING GRAPH**

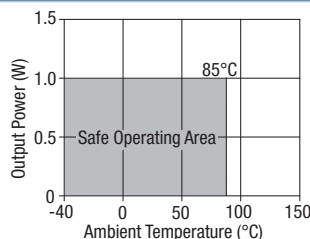

**PART NUMBER STRUCTURE**

**MTE 1 S XX XX M C**

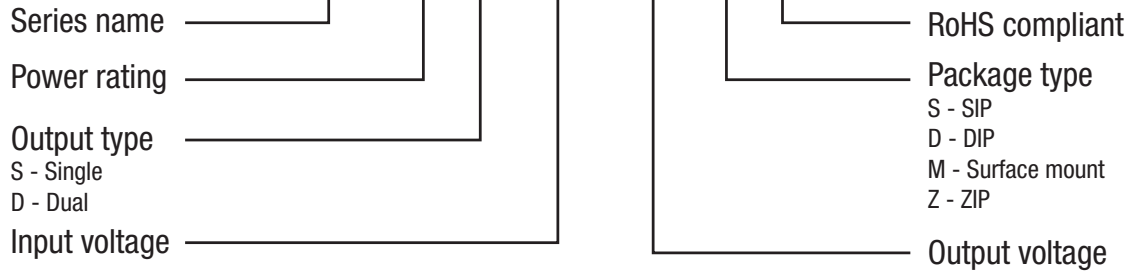

### APPLICATION NOTES

#### Advisory Notes

The MTE series is not hermetically sealed, customers should ensure that parts are fully dried before input power application.

The MTE has been tested to the following standards, which should not be exceeded for shock and vibration:

- BS EN 60068-2-64:2008 (Vibration Broadband Random)
- BS EN 60068-2-27:2009 (Mechanical Shock)

#### Minimum Load

The minimum load to meet datasheet specification is 10% of the full rated load across the specified input voltage range. Lower than 10% minimum loading will result in an increase in output voltage, which may rise to typically double the specified output voltage if the output load falls to less than 5%.w

#### Capacitive Loading & Start Up

Typical start up times for this series, with a typical input voltage rise time of 2.2µs and output capacitance of 10µF, are shown in the table below. The product series will start into a capacitance of 47µF with an increased start time, however, the maximum recommended output capacitance is 10µF.

|             | Start-up time |
|-------------|---------------|
|             | µs            |
| MTE1S0303MC | 140           |
| MTE1S0305MC | 270           |
| MTE1S0309MC | 830           |
| MTE1S0312MC | 1250          |
| MTE1S0315MC | 2330          |
| MTE1S0503MC | 130           |
| MTE1S0505MC | 170           |
| MTE1S0506MC | 210           |

|             | Start-up time |
|-------------|---------------|
|             | µs            |
| MTE1S0509MC | 355           |
| MTE1S0512MC | 670           |
| MTE1S0515MC | 1410          |
| MTE1S1205MC | 175           |
| MTE1S1209MC | 390           |
| MTE1S1212MC | 800           |
| MTE1S1215MC | 1360          |
| MTE1S1505MC | 130           |

|             | Start-up time |
|-------------|---------------|
|             | µs            |
| MTE1S1509MC | 310           |
| MTE1S1512MC | 440           |
| MTE1S1515MC | 770           |
| MTE1S2405MC | 110           |
| MTE1S2409MC | 230           |
| MTE1S2412MC | 400           |
| MTE1S2415MC | 590           |

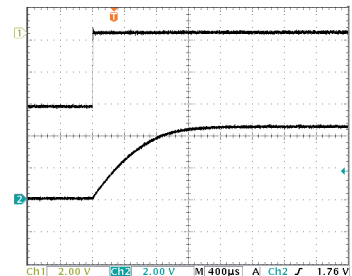

Typical Start-Up Wave Form

#### Output Ripple Reduction

By using the values of inductance and capacitance stated, the output ripple at the rated load is lowered to 5mV p-p max.

##### Component selection

**Capacitor:** It is required that the ESR (Equivalent Series Resistance) should be as low as possible, ceramic types are recommended. The voltage rating should be at least twice (except for 15V output), the rated output voltage of the DC-DC converter.

**Inductor:** The rated current of the inductor should not be less than that of the output of the DC-DC converter. At the rated current, the DC resistance of the inductor should be such that the voltage drop across the inductor is <2% of the rated voltage of the DC-DC converter. The SRF (Self Resonant Frequency) should be >20MHz.

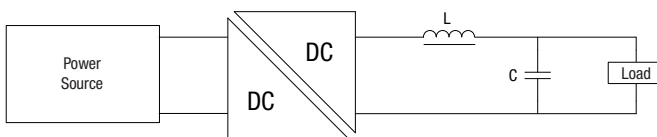

|             | Inductor |        |              | Capacitor |
|-------------|----------|--------|--------------|-----------|
|             | L, µH    | SMD    | Through Hole | C, µF     |
| MTE1S0303MC | 4.7      | 82472C | 11R472C      | 10        |
| MTE1S0305MC | 10       | 82103C | 11R103C      | 4.7       |
| MTE1S0309MC | 22       | 82223C | 11R223C      | 2.2       |
| MTE1S0312MC | 47       | 82473C | 11R473C      | 1         |
| MTE1S0315MC | 47       | 82473C | 11R473C      | 1         |
| MTE1S0503MC | 4.7      | 82472C | 11R472C      | 10        |
| MTE1S0505MC | 10       | 82103C | 11R103C      | 4.7       |
| MTE1S0506MC | 22       | 82223C | 11R223C      | 2.2       |
| MTE1S0509MC | 22       | 82223C | 11R223C      | 2.2       |
| MTE1S0512MC | 47       | 82473C | 11R473C      | 1         |
| MTE1S0515MC | 47       | 82473C | 11R473C      | 1         |
| MTE1S1205MC | 10       | 82103C | 11R103C      | 4.7       |
| MTE1S1209MC | 22       | 82223C | 11R223C      | 2.2       |
| MTE1S1212MC | 47       | 82473C | 11R473C      | 1         |
| MTE1S1215MC | 47       | 82473C | 11R473C      | 1         |
| MTE1S1505MC | 10       | 82103C | 11R103C      | 4.7       |
| MTE1S1509MC | 22       | 82223C | 11R103C      | 2.2       |
| MTE1S1512MC | 47       | 82473C | 11R473C      | 1         |
| MTE1S1515MC | 47       | 82473C | 11R473C      | 1         |
| MTE1S2405MC | 10       | 82103C | 11R103C      | 4.7       |
| MTE1S2409MC | 22       | 82223C | 11R223C      | 2.2       |
| MTE1S2412MC | 47       | 82473C | 11R473C      | 1         |
| MTE1S2415MC | 47       | 82473C | 11R473C      | 1         |

**TOLERANCE ENVELOPES**

The voltage tolerance envelope shows typical load regulation characteristics for this product series. The tolerance envelope is the maximum output voltage variation due to changes in output loading.

**0303, 0503**

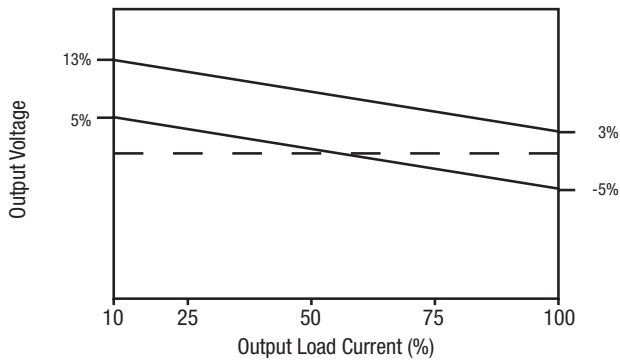

**0305, 0309**

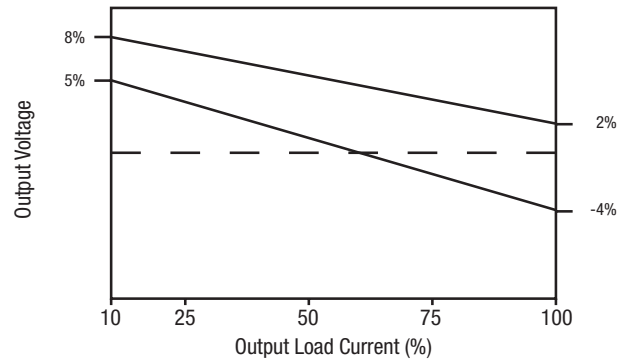

**0312, 0315, 0505, 0506, 0509**

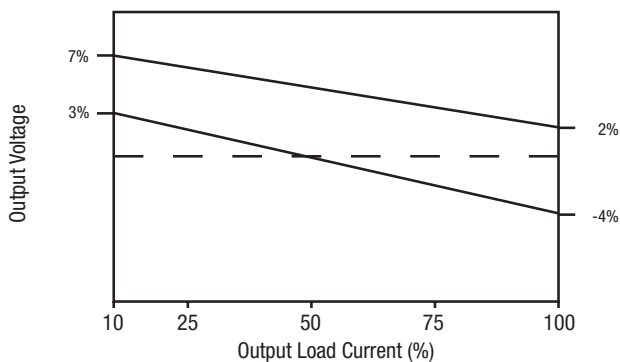

**1209, 1212, 1215, 15XX, 2409, 2412, 2415**

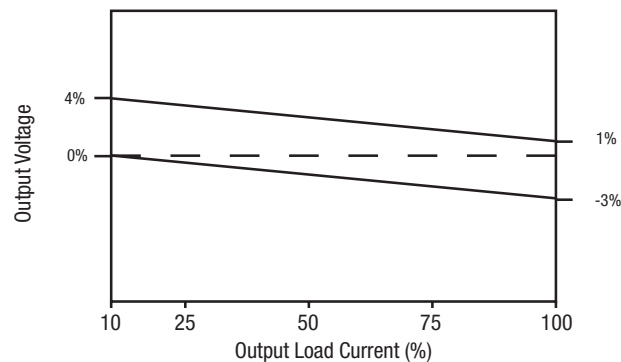

**0512, 0515, 1205, 2405**

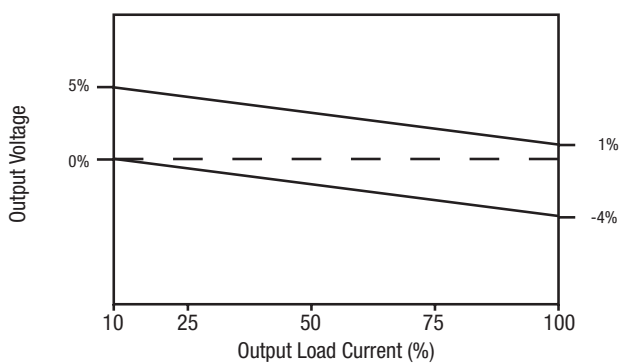

## EFFICIENCY VS LOAD

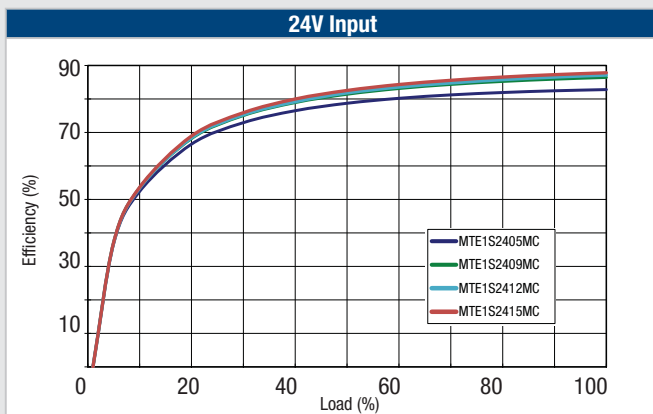
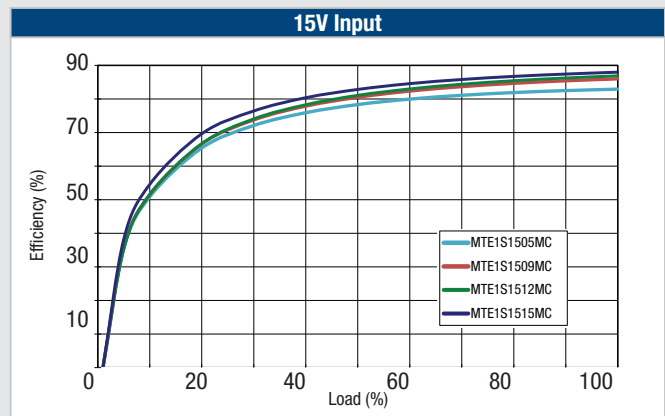
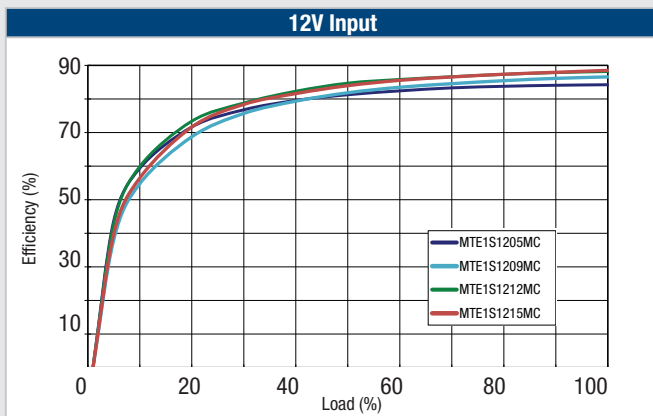
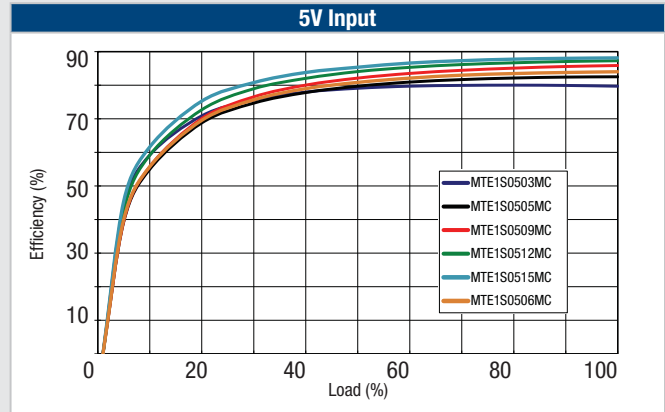
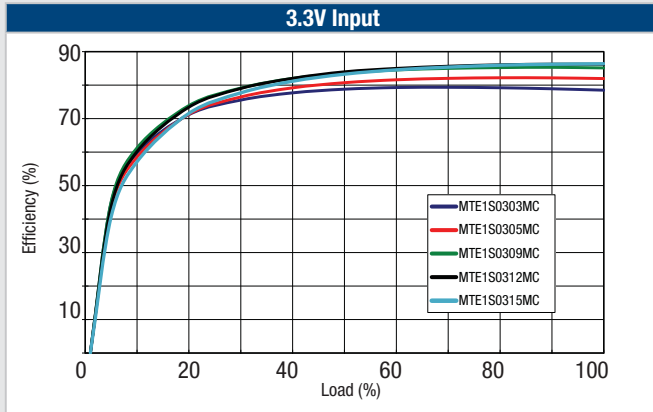

**EMC FILTERING AND SPECTRA**

**FILTERING**

A 22uF (100uF for the MTE1S2405MC), input capacitor is required to meet EN 55022 Curve B, Quasi-Peak EMC limit, as shown in the following plots.

**MTE1S0303MC**

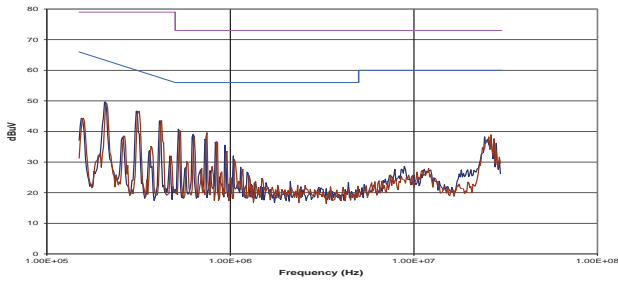

**MTE1S0305MC**

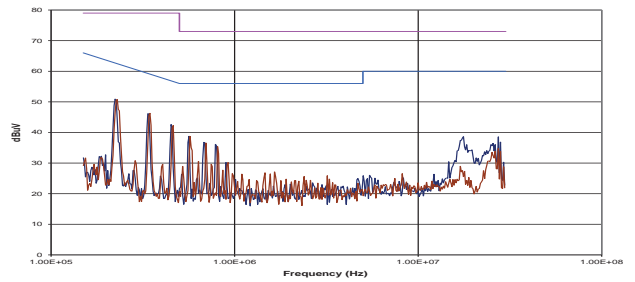

**MTE1S0309MC**

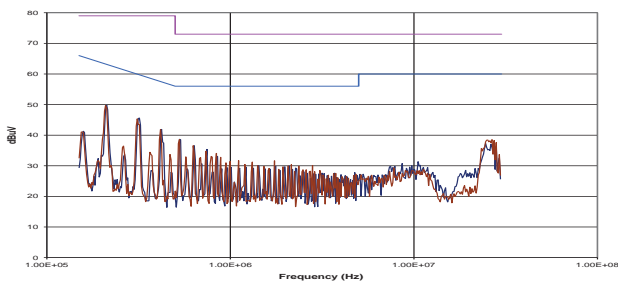

**MTE1S0312MC**

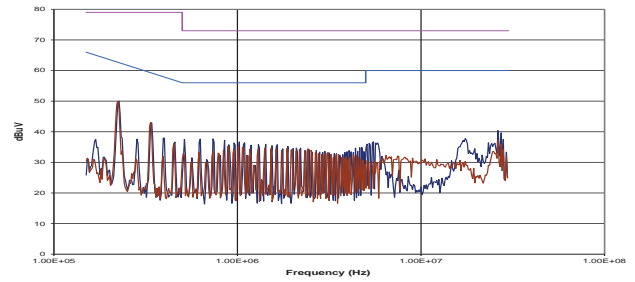

**MTE1S0315MC**

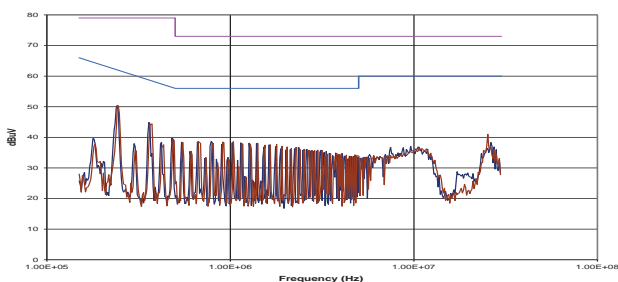

**MTE1S0503MC**

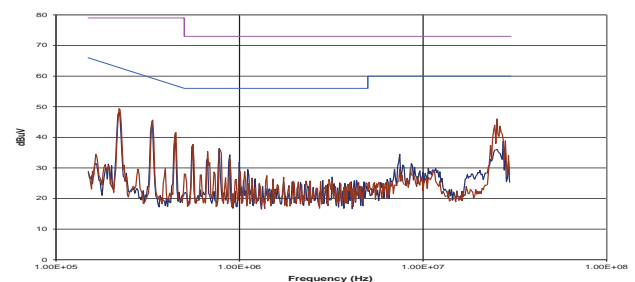

**EMC FILTERING AND SPECTRA (Continued)**

**MTE1S0505MC**

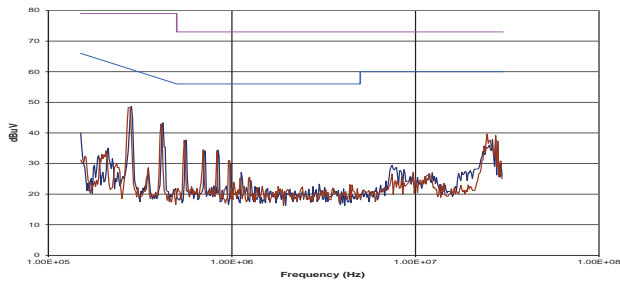

**MTE1S0506MC**

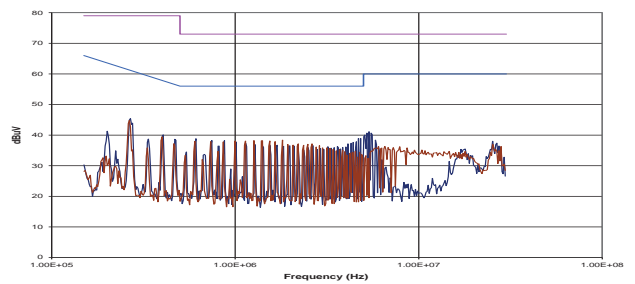

**MTE1S0509MC**

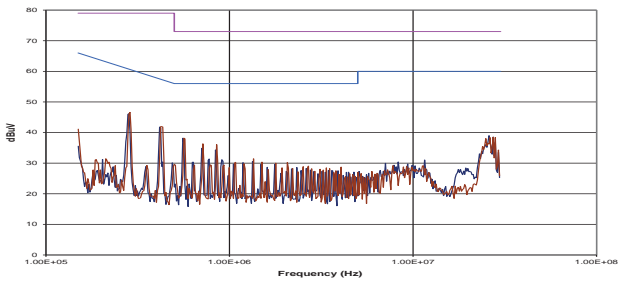

**MTE1S0512MC**

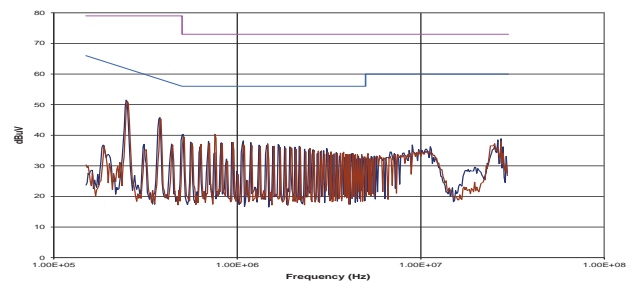

**MTE1S0515MC**

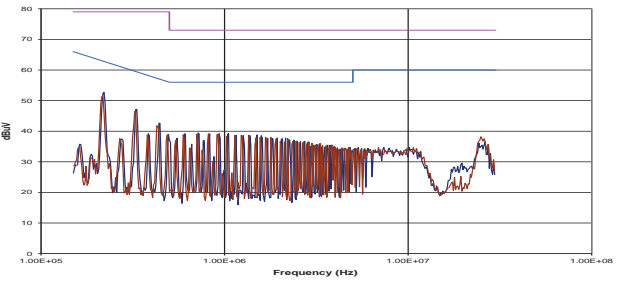

**MTE1S1205MC**

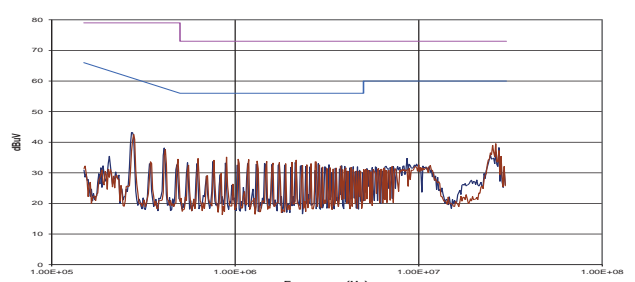

**MTE1S1209MC**

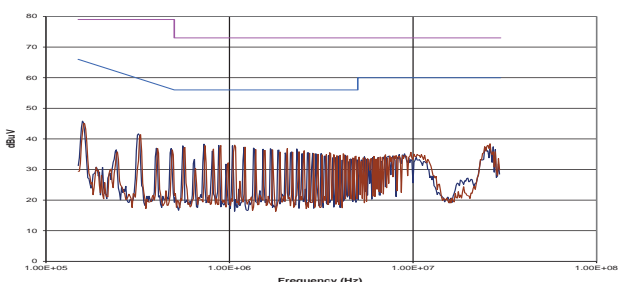

**MTE1S1212MC**

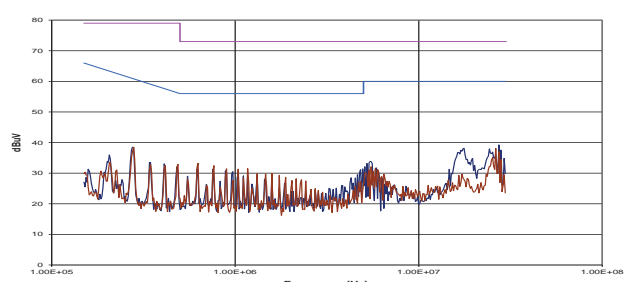

**EMC FILTERING AND SPECTRA (Continued)**

**MTE1S1215MC**

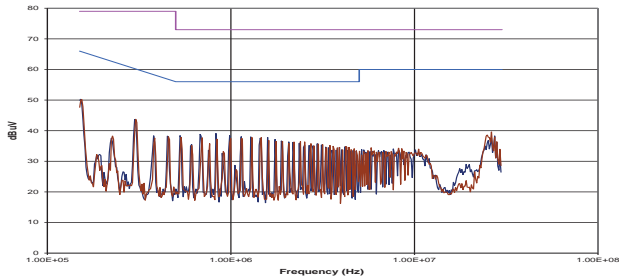

**MTE1S1505MC**

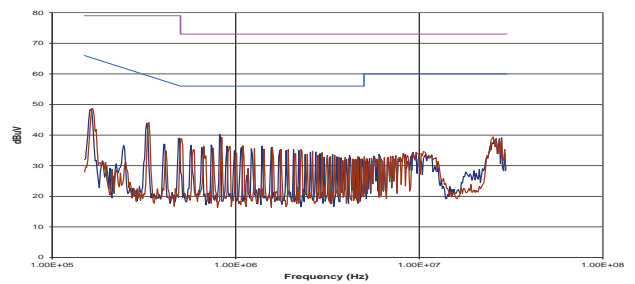

**MTE1S1509MC**

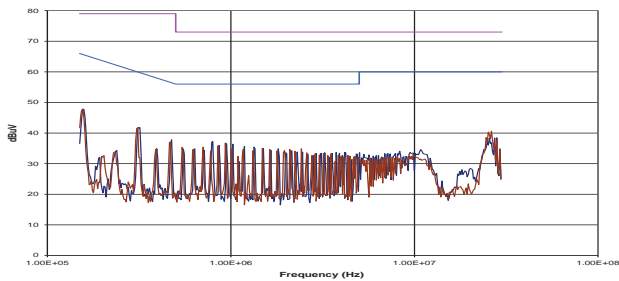

**MTE1S1512MC**

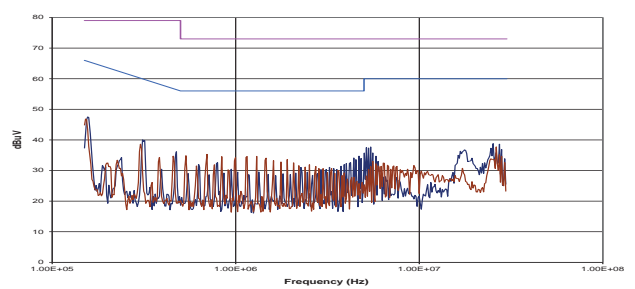

**MTE1S1515MC**

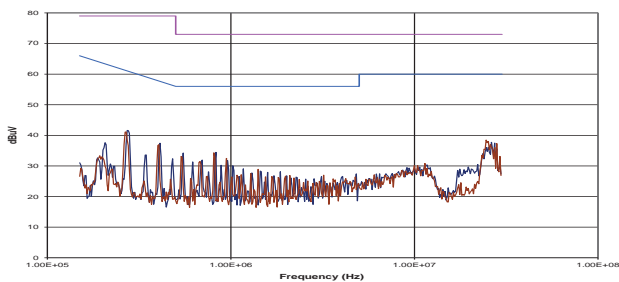

**MTE1S2405MC**

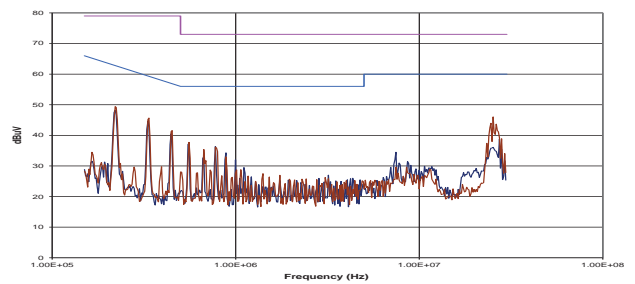

**MTE1S2409MC**

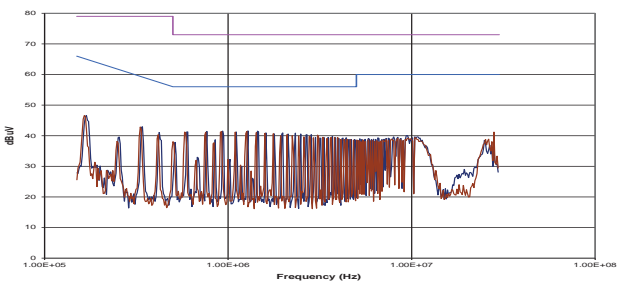

**MTE1S2412MC**

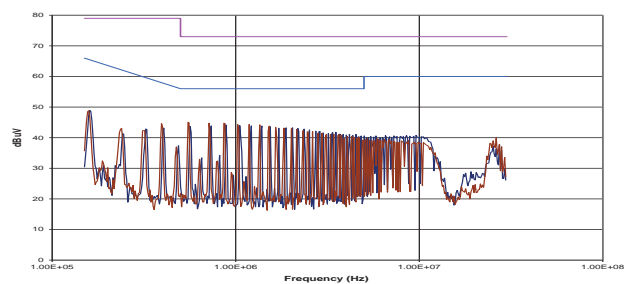

EMC FILTERING AND SPECTRA (Continued)

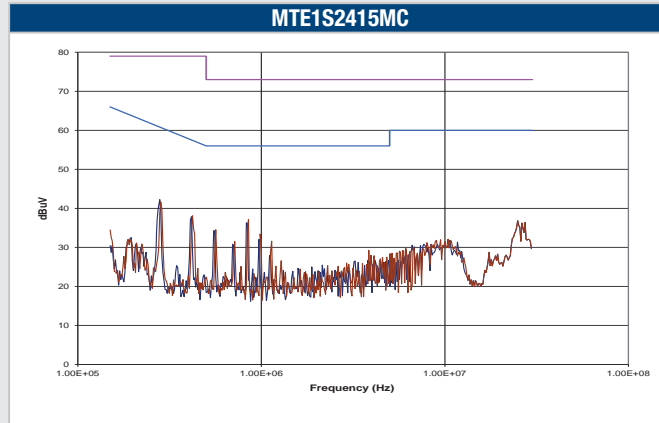



**TAPE & REEL SPECIFICATIONS**

**REEL OUTLINE DIMENSIONS**

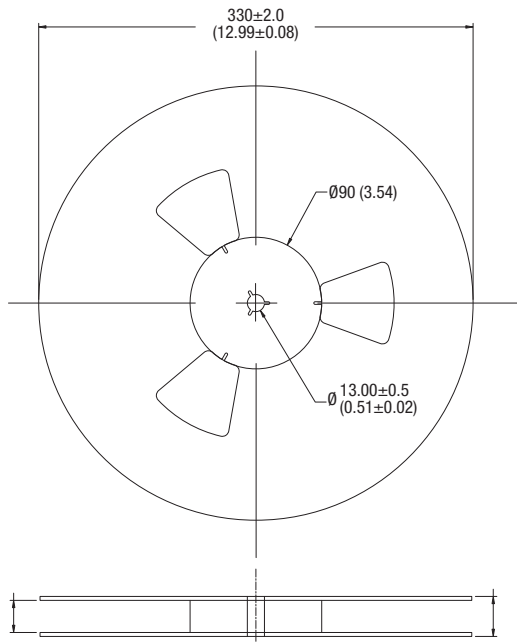

**TAPE OUTLINE DIMENSIONS**

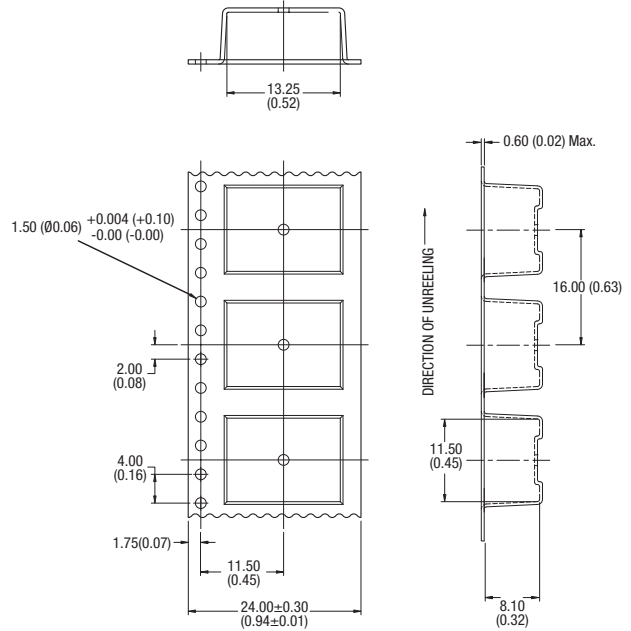

**REEL PACKAGING DETAILS**

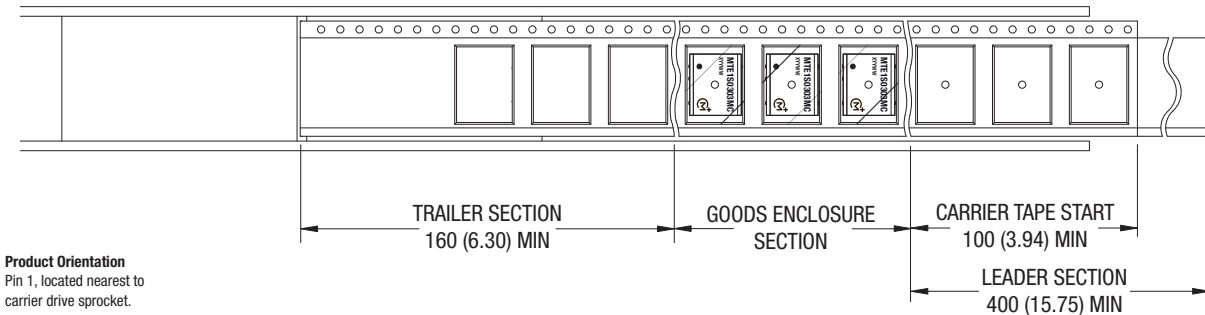

**Product Orientation**  
Pin 1, located nearest to  
carrier drive sprocket.

Reel Quantity: 500

**DISCLAIMER**

Unless otherwise stated in the datasheet, all products are designed for standard commercial and industrial applications and NOT for safety-critical and/or life-critical applications.

Particularly for safety-critical and/or life-critical applications, i.e. applications that may directly endanger or cause the loss of life, inflict bodily harm and/or loss or severe damage to equipment/property, and severely harm the environment, a prior explicit written approval from Murata is strictly required. Any use of Murata standard products for any safety-critical, life-critical or any related applications without any prior explicit written approval from Murata shall be deemed unauthorised use.

These applications include but are not limited to:

- Aircraft equipment
- Aerospace equipment
- Undersea equipment
- Power plant control equipment
- Medical equipment
- Transportation equipment (automobiles, trains, ships, etc.)
- Traffic signal equipment
- Disaster prevention / crime prevention equipment
- Data Processing equipment

Murata makes no express or implied warranty, representation, or guarantee of suitability, fitness for any particular use/purpose and/or compatibility with any application or device of the buyer, nor does Murata assume any liability whatsoever arising out of unauthorised use of any Murata product for the application of the buyer. The suitability, fitness for any particular use/purpose and/or compatibility of Murata product with any application or device of the buyer remain to be the responsibility and liability of the buyer.

Buyer represents and agrees that it has all the necessary expertise to create and implement safeguards that anticipate dangerous consequences of failures, monitor failures and their consequences, lessen the likelihood of failures that might cause harm, and take appropriate remedial actions. Buyer will fully indemnify and hold Murata, its affiliated companies, and its representatives harmless against any damages arising out of unauthorised use of any Murata products in any safety-critical and/or life-critical applications.

Remark: Murata in this section refers to Murata Manufacturing Company and its affiliated companies worldwide including, but not limited to, Murata Power Solutions.





This product is subject to the following [operating requirements](https://www.murata.com/en-eu/products/power/requirements) and the [Life and Safety Critical Application Sales Policy](https://www.murata.com/en-eu/products/power/requirements):

Refer to: <https://www.murata.com/en-eu/products/power/requirements>

Murata Power Solutions (Milton Keynes) Ltd. makes no representation that the use of its products in the circuits described herein, or the use of other technical information contained herein, will not infringe upon existing or future patent rights. The descriptions contained herein do not imply the granting of licenses to make, use, or sell equipment constructed in accordance therewith. Specifications are subject to change without notice.  
© 2023 Murata Power Solutions (Milton Keynes) Ltd.

## Looking for pricing, stock, or lifecycle information?

Click below to explore more details on WIN SOURCE:

-  [View MTE1S2405MC on WIN SOURCE](#)
-  [Murata Power Solutions Inc. Information](#)

## Optimize Your Supply Chain with WIN SOURCE Solutions

-  Global Sourcing Solution
-  Obsolete Management
-  Cost Control Management
-  Shortage Management
-  Alternative Solution
-  Excess Inventory Management