



**THE DATASHEET OF  
MAX6364LUT46+T**





# SOT23, Low-Power $\mu$ P Supervisory Circuits with Battery Backup

MAX6361-MAX6364

## General Description

The MAX6361–MAX6364 supervisory circuits reduce the complexity and number of components required for power-supply monitoring and battery control functions in microprocessor ( $\mu$ P) systems. The circuits significantly improve system reliability and accuracy compared to that obtainable with separate ICs or discrete components. Their functions include  $\mu$ P reset, backup battery switchover, and power failure warning.

The MAX6361–MAX6364 operate from supply voltages as low as +1.2V. The factory-preset reset threshold voltage ranges from 2.32V to 4.63V (see *Ordering Information*). These devices provide a manual reset input (MAX6361), watchdog timer input (MAX6362), battery-on output (MAX6363), and an auxiliary adjustable reset input (MAX6364). In addition, each part type is offered in three reset output versions: an active-low open-drain reset, an active-low open-drain reset, and an active-high open-drain reset (see *Selector Guide* at end of data sheet).

## Applications

|                           |                          |
|---------------------------|--------------------------|
| Computers                 | Fax Machines             |
| Controllers               | Industrial Control       |
| Intelligent Instruments   | POS Equipment            |
| Critical $\mu$ P/ $\mu$ C | Portable/Battery-Powered |
| Power Monitoring          | Equipment                |

## Pin Configurations

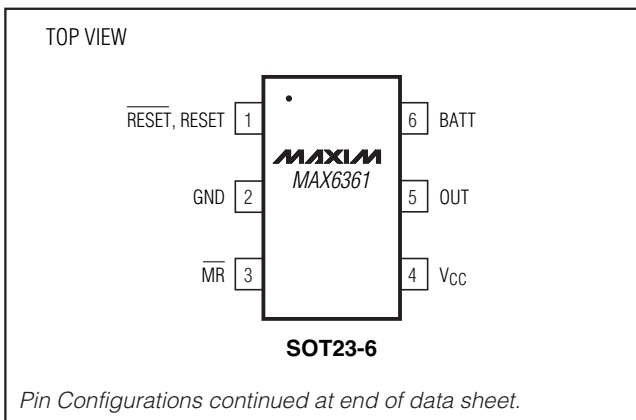

*Selector Guide appears at end of data sheet.*

*Typical Operating Circuit appears at end of data sheet.*

## Features

- ◆ Low +1.2V Operating Supply Voltage ( $V_{CC}$  or  $V_{BATT}$ )
- ◆ Precision Monitoring of +5.0V, +3.3V, +3.0V, and +2.5V Power-Supply Voltages
- ◆ Debounced Manual Reset Input (MAX6361)
- ◆ Watchdog Timer with 1.6s Timeout Period (MAX6362)
- ◆ Battery-On Output Indicator (MAX6363)
- ◆ Auxiliary User-Adjustable RESET IN (MAX6364)
- ◆ Three Available Output Structures  
Push-Pull RESET, Open-Drain RESET, Open-Drain RESET
- ◆ RESET/RESET Valid Down to 1.2V Guaranteed ( $V_{CC}$  or  $V_{BATT}$ )
- ◆ Power-Supply Transient Immunity
- ◆ 150ms (min) Reset Timeout Period
- ◆ Small 6-Pin SOT23 Package

## Ordering Information

| PART          | TEMP RANGE     | PIN-PACKAGE |
|---------------|----------------|-------------|
| MAX6361LUT__T | -40°C to +85°C | 6 SOT23     |
| MAX6361PUT__T | -40°C to +85°C | 6 SOT23     |
| MAX6361HUT__T | -40°C to +85°C | 6 SOT23     |
| MAX6362LUT__T | -40°C to +85°C | 6 SOT23     |
| MAX6362PUT__T | -40°C to +85°C | 6 SOT23     |
| MAX6362HUT__T | -40°C to +85°C | 6 SOT23     |
| MAX6363LUT__T | -40°C to +85°C | 6 SOT23     |
| MAX6363PUT__T | -40°C to +85°C | 6 SOT23     |
| MAX6363HUT__T | -40°C to +85°C | 6 SOT23     |
| MAX6364LUT__T | -40°C to +85°C | 6 SOT23     |
| MAX6364PUT__T | -40°C to +85°C | 6 SOT23     |
| MAX6364HUT__T | -40°C to +85°C | 6 SOT23     |

**Note:** These parts offer a choice of reset threshold voltages. From the table below, select the suffix corresponding to the desired threshold voltage and insert it into the part number to complete it. When ordering from the factory, there is a 2500-piece minimum on the SOT package (tape-and-reel only). Devices are available in both leaded and lead-free packaging. Specify lead-free by replacing "-T" with "+T" when ordering.

| SUFFIX | RESET THRESHOLD RANGES (V) |      |      |
|--------|----------------------------|------|------|
|        | MIN                        | TYP  | MAX  |
| 46     | 4.50                       | 4.63 | 4.75 |
| 44     | 4.25                       | 4.38 | 4.50 |
| 31     | 3.00                       | 3.08 | 3.15 |
| 29     | 2.85                       | 2.93 | 3.00 |
| 26     | 2.55                       | 2.63 | 2.70 |
| 23     | 2.25                       | 2.32 | 2.38 |



# SOT23, Low-Power $\mu$ P Supervisory Circuits with Battery Backup

## ABSOLUTE MAXIMUM RATINGS

|  |                               |
|--|-------------------------------|
| Terminal Voltages (with respect to GND)        |                               |
| $V_{CC}$ , BATT, OUT.....                      | -0.3V to +6V                  |
| RESET (open drain), RESET (open drain).....    | -0.3V to +6V                  |
| BATT ON, RESET (push-pull), RESET IN, WDI..... | -0.3V to ( $V_{OUT} + 0.3V$ ) |
| MR.....  | -0.3V to ( $V_{CC} + 0.3V$ )  |
| Input Current                                  |                               |
| $V_{CC}$ Peak.....                             | 1A                            |
| $V_{CC}$ Continuous.....                       | 250mA                         |
| BATT Peak.....                                 | 250mA                         |
| BATT Continuous.....                           | 40mA                          |
| GND.....                                       | 75mA                          |

|   |   |
|---|---|
| Output Current  |   |
| OUT.....  | Short-Circuit Protection for up to 10s      |
| RESET, RESET, BATT ON.....  | 20mA  |
| Continuous Power Dissipation ( $T_A = +70^\circ\text{C}$ )                    |   |
| 6-Pin SOT23 (derate 8.70mW/ $^\circ\text{C}$ above $+70^\circ\text{C}$ )..... | 696mW                                       |
| Operating Temperature Range.....  | $-40^\circ\text{C}$ to $+85^\circ\text{C}$  |
| Junction Temperature.....   | $+150^\circ\text{C}$                        |
| Storage Temperature Range.....  | $-65^\circ\text{C}$ to $+150^\circ\text{C}$ |
| Lead Temperature (soldering, 10s).....  | $+300^\circ\text{C}$                        |
| Soldering Temperature (reflow)  |   |
| Lead(Pb)-free.....  | $+260^\circ\text{C}$                        |
| Packages containing lead(Pb).....   | $+240^\circ\text{C}$                        |

Stresses beyond those listed under "Absolute Maximum Ratings" may cause permanent damage to the device. These are stress ratings only, and functional operation of the device at these or any other conditions beyond those indicated in the operational sections of the specifications is not implied. Exposure to absolute maximum rating conditions for extended periods may affect device reliability.

## ELECTRICAL CHARACTERISTICS

( $V_{CC} = +2.4V$  to  $+5.5V$ ,  $V_{BATT} = 3V$ ,  $T_A = -40^\circ\text{C}$  to  $+85^\circ\text{C}$ , reset not asserted. Typical values are at  $T_A = +25^\circ\text{C}$ , unless otherwise noted.) (Note 1)

| PARAMETER  | SYMBOL                | CONDITIONS   | MIN  | TYP               | MAX  | UNITS         |
|--|-----------------------|--|--|-------------------|------|---------------|
| Operating Voltage Range, $V_{CC}$ or $V_{BATT}$            | $V_{CC}$ , $V_{BATT}$ | No load (Note 2)   | 0  |                   | 5.5  | V             |
| Supply Current (Excluding $I_{OUT}$ )                      | $I_{CC}$              | No load, $V_{CC} > V_{TH}$ , WDI = $V_{CC}$ or GND (MAX6362) | $V_{CC} = 2.8V$                                  | 10                | 30   | $\mu\text{A}$ |
|  |                       |  | $V_{CC} = 3.6V$                                  | 11                | 35   |               |
|  |                       |  | $V_{CC} = 5.5V$                                  | 15                | 50   |               |
| $I_{SUPPLY}$ in Battery-Backup Mode (Excluding $I_{OUT}$ ) | $I_{SUPPLY}$          | $V_{BATT} = 2.8V$ , $V_{CC} = 0V$                            | $T_A = +25^\circ\text{C}$                        |                   | 1    | $\mu\text{A}$ |
|  |                       |  | $T_A = -40^\circ\text{C}$ to $+85^\circ\text{C}$ |                   | 3    |               |
| BATT Standby Current                                       | $I_{BATT}$            | $5.5V > V_{CC} > (V_{BATT} + 0.2V)$                          | $T_A = +25^\circ\text{C}$                        | -0.1              | 0.02 | $\mu\text{A}$ |
|  |                       |  | $T_A = -40^\circ\text{C}$ to $+85^\circ\text{C}$ | -1.0              | 0.05 |               |
| $V_{CC}$ to OUT On-Resistance                              | $R_{ON}$              | $V_{CC} = 4.75V$ , $I_{OUT} \leq 150mA$                      |  |                   | 2.75 | $\Omega$      |
|  |                       | $V_{CC} = 3.15V$ , $I_{OUT} \leq 65mA$                       |  |                   | 3.0  |               |
|  |                       | $V_{CC} = 2.38V$ , $I_{OUT} \leq 25mA$                       |  |                   | 4.6  |               |
| $V_{OUT}$ in Battery-Backup Mode                           |                       | $V_{BATT} = 4.5V$ , $I_{OUT} \leq 20mA$                      |  | $V_{BATT} - 0.2$  |      | V             |
|  |                       | $V_{BATT} = 3.0V$ , $I_{OUT} \leq 10mA$                      |  | $V_{BATT} - 0.15$ |      |               |
|  |                       | $V_{BATT} = 2.25V$ , $I_{OUT} \leq 5mA$                      |  | $V_{BATT} - 0.15$ |      |               |
| Battery-Switchover Threshold ( $V_{CC} - V_{BATT}$ )       |                       | $V_{CC} < V_{TH}$  | Power-up   | 20                |      | mV            |
|  |                       |  | Power-down                                       | -20               |      |               |
| Reset Threshold  | $V_{TH}$              | MAX636_UT46  | 4.50   | 4.63              | 4.75 | V             |
|  |                       | MAX636_UT44  | 4.25   | 4.38              | 4.50 |               |
|  |                       | MAX636_UT31  | 3.00   | 3.08              | 3.15 |               |
|  |                       | MAX636_UT29  | 2.85   | 2.93              | 3.00 |               |
|  |                       | MAX636_UT26  | 2.55   | 2.63              | 2.70 |               |
|  |                       | MAX636_UT23  | 2.25   | 2.32              | 2.38 |               |
| $V_{CC}$ Falling Reset Delay                               |                       | $V_{CC}$ falling at 10V/ms                                   |  | 35                |      | $\mu\text{s}$ |
| Reset-Active Timeout Period                                | $t_{RP}$              |  | 150  |                   | 280  | ms            |

# SOT23, Low-Power $\mu$ P Supervisory Circuits with Battery Backup

MAX6361-MAX6364

## ELECTRICAL CHARACTERISTICS (continued)

( $V_{CC} = +2.4V$  to  $+5.5V$ ,  $V_{BATT} = 3V$ ,  $T_A = -40^{\circ}C$  to  $+85^{\circ}C$ , reset not asserted. Typical values are at  $T_A = +25^{\circ}C$ , unless otherwise noted.) (Note 1)

| PARAMETER                            | SYMBOL           | CONDITIONS                                 |  | MIN                 | TYP        | MAX                 | UNITS      |
|--------------------------------------|------------------|--|--|---------------------|------------|---------------------|------------|
| RESET Output Voltage                 | V <sub>OL</sub>  | Reset asserted, $V_{BATT} = 0V$            | $I_{SINK} = 1.6mA$ ,<br>$V_{CC} \geq 2.1V$             |                     |            | 0.3                 | V          |
|                                      |                  |  | $I_{SINK} = 100\mu A$ ,<br>$V_{CC} \geq 1.2V$          |                     |            | 0.4                 |            |
|                                      | V <sub>OH</sub>  | Reset not asserted (MAX636_L only)         | $I_{SOURCE} = 500\mu A$ ,<br>$V_{CC} \geq V_{TH(MAX)}$ | $0.8 \times V_{CC}$ |            |                     |            |
| RESET Output Voltage                 | V <sub>OL</sub>  | Reset not asserted                         | $I_{SINK} = 1.6mA$ ,<br>$V_{CC} \geq V_{TH(MAX)}$      |                     |            | 0.3                 | V          |
| RESET, RESET Output Leakage Current  | I <sub>LK</sub>  | MAX636_P, MAX636_H only                    |  |                     |            | 1                   | $\mu A$    |
| <b>MANUAL RESET (MAX6361 only)</b>   |                  |  |  |                     |            |                     |            |
| MR Input Voltage                     | V <sub>IL</sub>  |  |  |                     |            | $0.3 \times V_{CC}$ | V          |
|                                      | V <sub>IH</sub>  |  |  | $0.7 \times V_{CC}$ |            |                     |            |
| Pull-Up Resistance                   |                  |  |  | 20                  |            |                     | k $\Omega$ |
| Minimum Pulse Width                  |                  |  |  | 1                   |            |                     | $\mu s$    |
| Glitch Immunity                      |                  | $V_{CC} = 3.3V$                            |  |                     | 100        |                     | ns         |
| MR to Reset Delay                    |                  | $V_{CC} = 3.3V$                            |  |                     | 120        |                     | ns         |
| <b>WATCHDOG INPUT (MAX6362 only)</b> |                  |  |  |                     |            |                     |            |
| Watchdog Timeout Period              | t <sub>WD</sub>  |  |  | 1.00                | 1.60       | 2.25                | s          |
| Minimum WDI Input Pulse Width        | t <sub>WDI</sub> |  |  | 100                 |            |                     | ns         |
| Input Voltage                        | V <sub>IL</sub>  |  |  |                     |            | $0.3 \times V_{CC}$ | V          |
|                                      | V <sub>IH</sub>  |  |  | $0.7 \times V_{CC}$ |            |                     |            |
| <b>BATT ON (MAX6363 only)</b>        |                  |  |  |                     |            |                     |            |
| Output Voltage                       | V <sub>OL</sub>  | $I_{SINK} = 3.2mA$ , $V_{BATT} = 2.1V$     |  |                     |            | 0.4                 | V          |
| Output Short-Circuit Current         |                  | Sink current, $V_{CC} = 5V$                |  |                     | 60         |                     | mA         |
|                                      |                  | Source current, $V_{BATT} \geq 2V$         |  | 10                  | 30         | 100                 | $\mu A$    |
| <b>RESET IN (MAX6364 only)</b>       |                  |  |  |                     |            |                     |            |
| Input Threshold                      |                  |  |  | 1.185               | 1.235      | 1.285               | V          |
| RESET IN Leakage Current             |                  |  |  |                     | $\pm 0.01$ | $\pm 25$            | nA         |
| RESET IN to Reset Delay              |                  | Overdrive voltage = 50mV, RESET IN falling |  |                     | 1.5        |                     | $\mu s$    |

**Note 1:** All devices are 100% production tested at  $T_A = +25^{\circ}C$ . Limits over temperature are guaranteed by design.

**Note 2:**  $V_{BATT}$  can be 0V anytime or  $V_{CC}$  can go down to 0V if  $V_{BATT}$  is active (except at startup).

# SOT23, Low-Power $\mu$ P Supervisory Circuits with Battery Backup

## Typical Operating Characteristics

( $T_A = +25^\circ\text{C}$ , unless otherwise noted.)

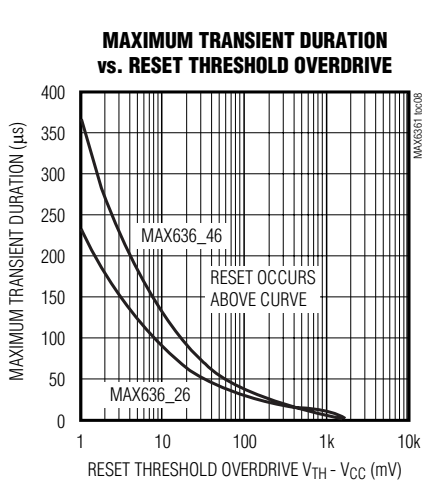
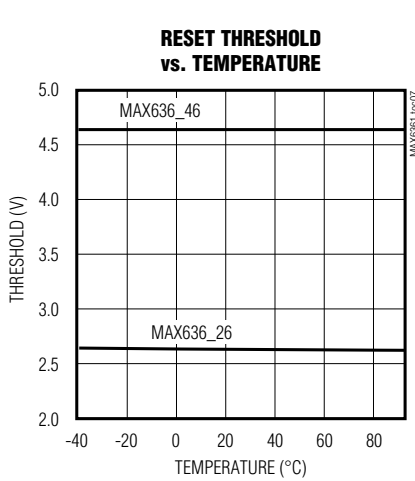
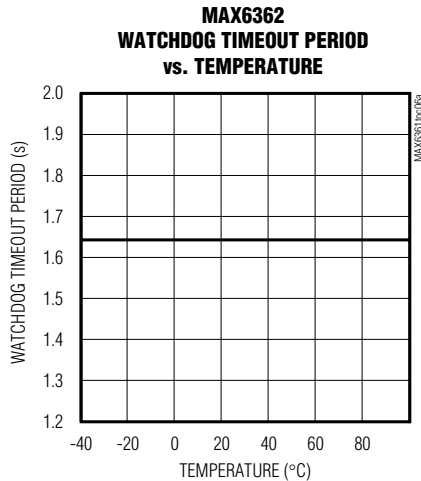
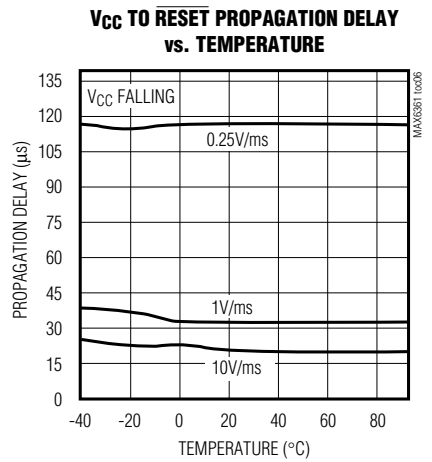
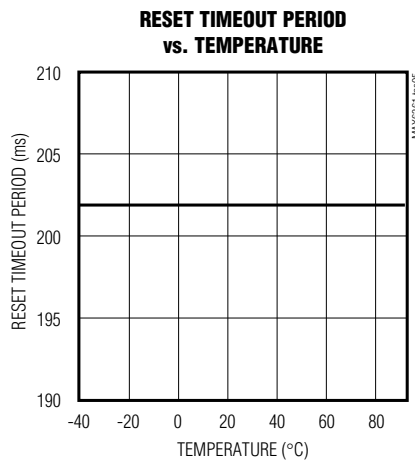
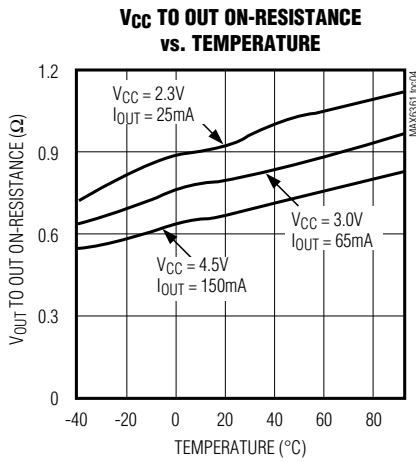
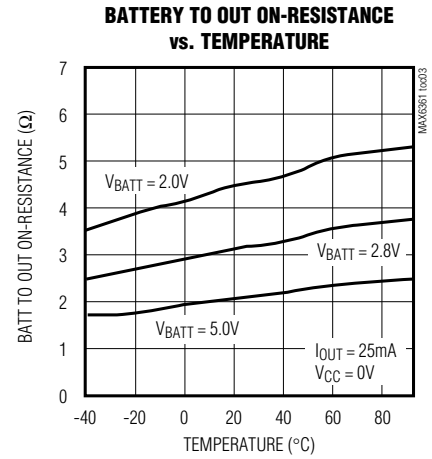
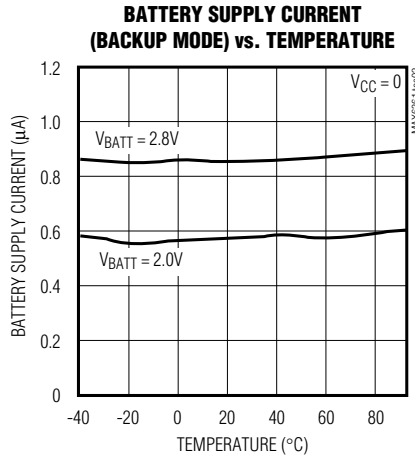
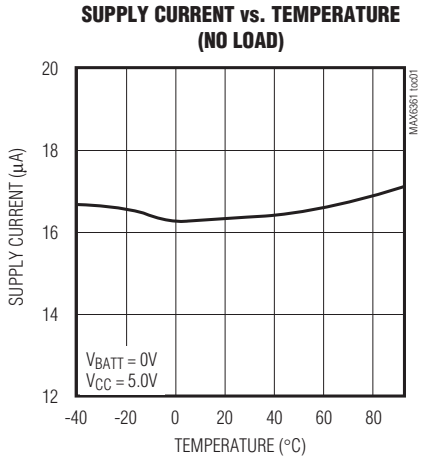

# SOT23, Low-Power $\mu$ P Supervisory Circuits with Battery Backup

## Typical Operating Characteristics (continued)

( $T_A = +25^\circ\text{C}$ , unless otherwise noted.)



## Pin Description

| PIN | NAME                      | FUNCTION   |
|-----|---------------------------|--|
| 1   | RESET                     | Active-High Reset Output. RESET is continuously high when $V_{CC}$ is below the reset threshold ( $V_{TH}$ ), $\overline{MR}$ is low, or RESET IN is low. It asserts in pulses when the internal watchdog times out. RESET remains high for the reset timeout period ( $t_{RP}$ ) after $V_{CC}$ rises above the reset threshold, after the manual reset input goes from low to high, after RESET IN goes high, or after the watchdog triggers a reset event. The MAX636_H is an active-high open-drain output.  |
|     | $\overline{\text{RESET}}$ | Active-Low Reset Output. $\overline{\text{RESET}}$ is continuously low when $V_{CC}$ is below the reset threshold ( $V_{TH}$ ), $\overline{MR}$ is low, or RESET IN is low. It asserts in pulses when the internal watchdog times out. $\overline{\text{RESET}}$ remains low for the reset timeout period ( $t_{RP}$ ) after $V_{CC}$ rises above the reset threshold, after the manual reset input goes from low to high, after RESET IN goes high, or after the watchdog triggers a reset event. The MAX636_L is an active-low push-pull output while the MAX636_P is an active-low open-drain output. |
| 2   | GND                       | Ground   |
| 3   | $\overline{MR}$           | <b>MAX6361</b> Manual-Reset Input. Maintaining logic low on $\overline{MR}$ asserts a reset. Reset output remains asserted for at least 150ms ( $t_{RP}$ ) after $\overline{MR}$ transitions from low to high. Leave unconnected or connected to $V_{CC}$ if not used.   |
|     | WDI                       | <b>MAX6362</b> Watchdog Input. If WDI remains high or low for longer than the watchdog timeout period ( $t_{WD}$ ), the internal watchdog timer runs out and a reset pulse is triggered for the reset timeout period ( $t_{RP}$ ) (Figure 1). The internal watchdog clears whenever reset asserts or whenever WDI sees a rising or falling edge.   |
|     | BATT ON                   | <b>MAX6363</b> Battery-On Output. BATT ON goes high in battery backup mode.  |
|     | RESET IN                  | <b>MAX6364</b> Reset Input. When RESET IN falls below 1.235V, reset is asserted. Reset output remains asserted as long as RESET IN is low and for at least 150ms ( $t_{RP}$ ) after RESET IN goes high.  |
| 4   | $V_{CC}$                  | Supply Voltage, 0 to 5.5V. Reset is asserted when $V_{CC}$ drops below the reset threshold voltage ( $V_{TH}$ ). Reset remains asserted until $V_{CC}$ rises above $V_{TH}$ and for at least 150ms after $V_{CC}$ rises above $V_{TH}$ .   |
| 5   | OUT                       | Output. OUT sources from $V_{CC}$ when it is above the reset threshold ( $V_{TH}$ ), and from the greater of $V_{CC}$ or BATT when $V_{CC}$ is below $V_{TH}$ .  |
| 6   | BATT                      | Backup-Battery Input. When $V_{CC}$ falls below the reset threshold, BATT switches to OUT if $V_{BATT}$ is 20mV greater than $V_{CC}$ . When $V_{CC}$ rises 20mV above $V_{BATT}$ , $V_{CC}$ switches to OUT. The 40mV hysteresis prevents repeated switching if $V_{CC}$ falls slowly.  |

# SOT23, Low-Power $\mu$ P Supervisory Circuits with Battery Backup

## Detailed Description

The *Typical Operating Circuit* shows a typical connection for the MAX6361–MAX6364 family. OUT powers the static random-access memory (SRAM). OUT is internally connected to VCC if VCC is greater than the reset threshold, or to the greater of VCC or VBATT when VCC is less than the reset threshold. OUT can supply up to 150mA from VCC. When VCC is higher than VBATT, the BATT ON (MAX6363) output is low. When VCC is lower than VBATT, an internal MOSFET connects the backup battery to OUT. The on-resistance of the MOSFET is a function of backup-battery voltage and is shown in the Battery to Out On-Resistance vs. Temperature graph in the *Typical Operating Characteristics* section.

### Backup-Battery Switchover

In a brownout or power failure, it may be necessary to preserve the contents of the RAM. With a backup battery installed at BATT, the MAX6361–MAX6364 automatically switch the RAM to backup power when VCC falls. The MAX6363 has a BATT ON output that goes high when in battery-backup mode. These devices require two conditions before switching to battery-backup mode:

- 1) VCC must be below the reset threshold.
- 2) VCC must be below VBATT.

Table 1 lists the status of the inputs and outputs in battery-backup mode. The device will not power up if the only voltage source is on BATT. OUT will only power up from VCC at startup.

### Manual Reset Input (MAX6361 Only)

Many  $\mu$ P-based products require manual reset capability, allowing the operator, a test technician, or external logic circuitry to initiate a reset. For the MAX6361, a logic low on  $\overline{MR}$  asserts reset. Reset remains asserted while  $\overline{MR}$  is low, and for a minimum of 150ms ( $t_{RP}$ ) after it returns high.  $\overline{MR}$  has an internal 20k $\Omega$  pull-up resistor to VCC. This input can be driven with TTL/CMOS logic levels or with open-drain/collector outputs. Connect a normally open momentary switch from  $\overline{MR}$  to GND to create a manual reset function; external debounce circuitry is not required. If  $\overline{MR}$  is driven from long cables or the device is used in a noisy environment, connect a 0.1 $\mu$ F capacitor from  $\overline{MR}$  to GND to provide additional noise immunity.

### Watchdog Input (MAX6362 Only)

The watchdog monitors  $\mu$ P activity through the input WDI. If the  $\mu$ P becomes inactive, the reset output is asserted in pulses. To use the watchdog function, connect WDI to a bus line or  $\mu$ P I/O line. A change of state

(high to low or low to high) within the watchdog timeout period ( $t_{WD}$ ) with a 100ns minimum pulse width clears the watchdog timer. If WDI remains high or low for longer than the watchdog timeout period, the internal watchdog timer runs out and a reset pulse is triggered for the reset timeout period ( $t_{RP}$ ). The internal watchdog timer clears whenever reset asserts or the WDI sees a rising or falling edge within the watchdog timeout period. If WDI remains in a high or low state for an extended period of time, a reset pulse asserts after every watchdog timeout period ( $t_{WD}$ ) (Figure 1).

### Reset In (MAX6364 Only)

RESET IN is compared to an internal 1.235V reference. If the voltage at RESET IN is less than 1.235V, reset is asserted. The RESET IN comparator may be used as an undervoltage detector to signal a failing power supply. It can also be used as a secondary power-supply reset monitor.

To program the reset threshold ( $V_{RTH}$ ) of the secondary power supply, use the following equation (see *Typical Operating Circuit*):

$$V_{RTH} = V_{REF} \left( \frac{R1}{R2} + 1 \right)$$

where  $V_{REF} = 1.235V$ . To simplify the resistor selection,

$$R1 = R2 \left[ \left( V_{RTH} / V_{REF} \right) - 1 \right]$$

choose a value for R2 and calculate R1:

Since the input current at RESET IN is 25nA (max), large values (up to 1M $\Omega$ ) can be used for R2 with no significant loss in accuracy. For example, in the *Typical*

**Table 1. Input and Output Status in Battery-Backup Mode**

| PIN                             | STATUS   |
|---------------------------------|--|
| VCC                             | Disconnected from OUT  |
| OUT                             | Connected to BATT  |
| BATT                            | Connected to OUT. Current drawn from the battery is less than 1 $\mu$ A (at VBATT = 2.8V, excluding I <sub>OUT</sub> ) when VCC = 0. |
| RESET/ $\overline{RESET}$       | Asserted   |
| BATT ON                         | High state   |
| $\overline{MR}$ , RESET IN, WDI | Inputs ignored   |

# SOT23, Low-Power $\mu$ P Supervisory Circuits with Battery Backup

*Operating Circuit*, the MAX6362 monitors two supply voltages. To monitor the secondary 5V logic or analog supply with a 4.60V nominal programmed reset threshold, choose  $R2 = 100k\Omega$ , and calculate  $R1 = 273k\Omega$ .

## Reset Output

A  $\mu$ P's reset input starts the  $\mu$ P in a known state. The MAX6361-MAX6364  $\mu$ P supervisory circuits assert a reset to prevent code-execution errors during power-up, power-down, and brownout conditions. RESET is guaranteed to be a logic low or high depending on the device chosen (see *Ordering Information*). RESET or  $\overline{\text{RESET}}$  asserts when  $V_{CC}$  is below the reset threshold and for at least 150ms ( $t_{RP}$ ) after  $V_{CC}$  rises above the reset threshold. RESET or  $\overline{\text{RESET}}$  also asserts when  $\overline{\text{MR}}$  is low (MAX6361) and when RESET IN is less than 1.235V (MAX6364). The MAX6362 watchdog function will cause RESET (or  $\overline{\text{RESET}}$ ) to assert in pulses following a watchdog timeout (Figure 1).

## Applications Information

### Operation Without a Backup Power Source

The MAX6361-MAX6364 were designed for battery-backed applications. If a backup battery is not used, connect  $V_{CC}$  to OUT and connect BATT to GND.

## Replacing the Backup Battery

If BATT is decoupled with a 0.1 $\mu$ F capacitor to ground, the backup power source can be removed while  $V_{CC}$  remains valid without danger of triggering a reset pulse. The device does not enter battery-backup mode when  $V_{CC}$  stays above the reset threshold voltage.

## Negative-Going VCC Transients

These supervisors are relatively immune to short-duration, negative-going  $V_{CC}$  transients. Resetting the  $\mu$ P when  $V_{CC}$  experiences only small glitches is usually not desirable.

The *Typical Operating Characteristics* section shows a graph of Maximum Transient Duration vs. Reset Threshold Overdrive for which reset is not asserted. The graph was produced using negative-going  $V_{CC}$  pulses, starting at  $V_{CC}$  and ending below the reset threshold by the magnitude indicated (reset threshold overdrive). The graph shows the maximum pulse width that a negative-going  $V_{CC}$  transient can typically have without triggering a reset pulse. As the amplitude of the transient increases (i.e., goes further below the reset threshold), the maximum allowable pulse width decreases. Typically, a  $V_{CC}$  transient that goes 100mV below the reset threshold and lasts for 30 $\mu$ s will not trigger a reset pulse.

A 0.1 $\mu$ F bypass capacitor mounted close to the  $V_{CC}$  pin provides additional transient immunity.



Figure 1. MAX6362 Watchdog Timeout Period and Reset Active Time

## SOT23, Low-Power $\mu$ P Supervisory Circuits with Battery Backup

### Watchdog Software Considerations (MAX6362 Only)

To help the watchdog timer monitor software execution more closely, set and reset the watchdog input at different points in the program, rather than “pulsing” the watchdog input low-high-low. This technique avoids a “stuck” loop, in which the watchdog timer would continue to be reset within the loop, keeping the watchdog from timing out. Figure 2 shows an example of a flow diagram where the I/O driving the WDI is set low at the beginning of the program, set high at the beginning of every subroutine or loop, then set low again when the program returns to the beginning. If the program should “hang” in any subroutine, the problem would quickly be corrected, since the I/O is continually set low and the watchdog timer is allowed to time out, triggering a reset.

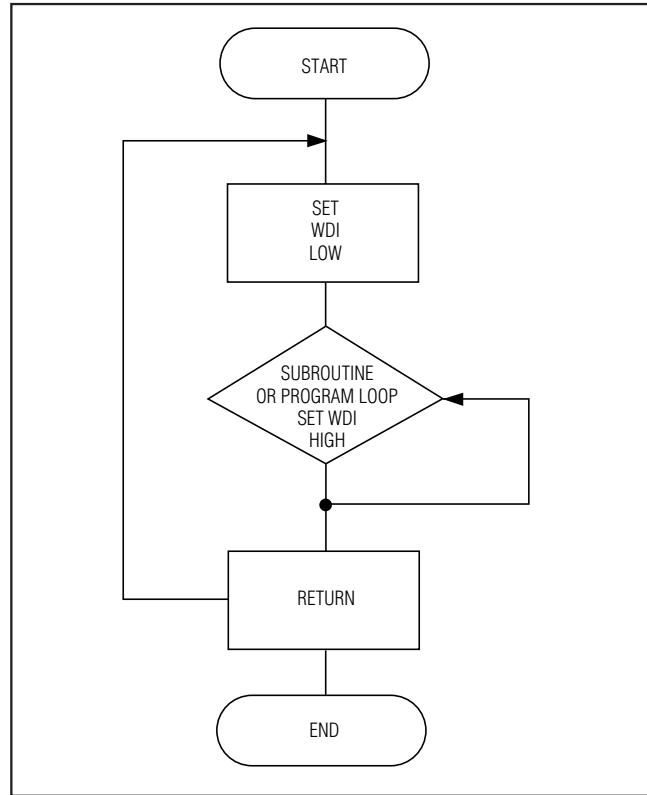

Figure 2. Watchdog Flow Diagram

# SOT23, Low-Power $\mu$ P Supervisory Circuits with Battery Backup

## Selector Guide

| PART                  | MANUAL<br>RESET<br>INPUT<br>$\overline{\text{MR}}$ | WATCHDOG<br>INPUT WDI | BATT<br>ON | RESET<br>IN | $\overline{\text{RESET}}$<br>PUSH-<br>PULL | $\overline{\text{RESET}}$<br>OPEN<br>DRAIN | RESET<br>OPEN<br>DRAIN |
|-----------------------|--|-----------------------|------------|-------------|--|--|------------------------|
| <b>MAX6361</b> LUT_ _ | ✓  |                       |            |             | ✓  |  |                        |
| MAX6361PUT_ _         | ✓  |                       |            |             |  | ✓  |                        |
| MAX6361HUT_ _         | ✓  |                       |            |             |  |  | ✓                      |
| <b>MAX6362</b> LUT_ _ |  | ✓                     |            |             | ✓  |  |                        |
| MAX6362PUT_ _         |  | ✓                     |            |             |  | ✓  |                        |
| MAX6362HUT_ _         |  | ✓                     |            |             |  |  | ✓                      |
| <b>MAX6363</b> LUT_ _ |  |                       | ✓          |             | ✓  |  |                        |
| MAX6363PUT_ _         |  |                       | ✓          |             |  | ✓  |                        |
| MAX6363HUT_ _         |  |                       | ✓          |             |  |  | ✓                      |
| <b>MAX6364</b> LUT_ _ |  |                       |            | ✓           | ✓  |  |                        |
| MAX6364PUT_ _         |  |                       |            | ✓           |  | ✓  |                        |
| MAX6364HUT_ _         |  |                       |            | ✓           |  |  | ✓                      |

**MAX6361-MAX6364**

## Device Marking Codes

| PART                 | TOP<br>MARK | PART                 | TOP<br>MARK | PART                 | TOP<br>MARK | PART                 | TOP<br>MARK |
|----------------------|-------------|----------------------|-------------|----------------------|-------------|----------------------|-------------|
| <b>MAX6361</b> LUT23 | AAEI        | <b>MAX6362</b> LUT23 | AAFA        | <b>MAX6363</b> LUT23 | AAFS        | <b>MAX6364</b> LUT23 | AAGK        |
| MAX6361LUT26         | AAEH        | MAX6362LUT26         | AAEZ        | MAX6363LUT26         | AAFR        | MAX6364LUT26         | AAGJ        |
| MAX6361LUT29*        | AAEG        | MAX6362LUT29*        | AAEY        | MAX6363LUT29*        | AAFQ        | MAX6364LUT29*        | AAGI        |
| MAX6361LUT31         | AAEF        | MAX6362LUT31         | AAEX        | MAX6363LUT31         | AAFP        | MAX6364LUT31         | AAGH        |
| MAX6361LUT44         | AAEE        | MAX6362LUT44         | AAEW        | MAX6363LUT44         | AAFO        | MAX6364LUT44         | AAGG        |
| MAX6361LUT46*        | AAED        | MAX6362LUT46*        | AAEV        | MAX6363LUT46*        | AAFN        | MAX6364LUT46*        | AAGF        |
| MAX6361PUT23         | AAEO        | MAX6362PUT23         | AAFG        | MAX6363PUT23         | AAFY        | MAX6364PUT23         | AAGQ        |
| MAX6361PUT26         | AAEN        | MAX6362PUT26         | AAFF        | MAX6363PUT26         | AAFX        | MAX6364PUT26         | AAGP        |
| MAX6361PUT29*        | AAEM        | MAX6362PUT29*        | AAFE        | MAX6363PUT29*        | AAFW        | MAX6364PUT29*        | AAGO        |
| MAX6361PUT31         | AAEL        | MAX6362PUT31         | AAFD        | MAX6363PUT31         | AAFV        | MAX6364PUT31         | AAGN        |
| MAX6361PUT44         | AAEK        | MAX6362PUT44         | AAFC        | MAX6363PUT44         | AAFU        | MAX6364PUT44         | AAGM        |
| MAX6361PUT46*        | AAEJ        | MAX6362PUT46*        | AAFB        | MAX6363PUT46*        | AAFT        | MAX6364PUT46*        | AAGL        |
| MAX6361HUT23         | AAEU        | MAX6362HUT23         | AAFM        | MAX6363HUT23         | AAGE        | MAX6364HUT23         | AAGW        |
| MAX6361HUT26         | AAET        | MAX6362HUT26         | AAFL        | MAX6363HUT26         | AAGD        | MAX6364HUT26         | AAGV        |
| MAX6361HUT29         | AAES        | MAX6362HUT29         | AAFK        | MAX6363HUT29         | AAGC        | MAX6364HUT29         | AAGU        |
| MAX6361HUT31         | AAER        | MAX6362HUT31         | AAFJ        | MAX6363HUT31         | AAGB        | MAX6364HUT31         | AAGT        |
| MAX6361HUT44         | AAEQ        | MAX6362HUT44         | AAFI        | MAX6363HUT44         | AAGA        | MAX6364HUT44         | AAGS        |
| MAX6361HUT46*        | AAEP        | MAX6362HUT46*        | AAFH        | MAX6363HUT46*        | AAFZ        | MAX6364HUT46*        | AAGR        |

\*Sample stock generally held on standard versions only. Contact factory for availability of nonstandard versions.

# SOT23, Low-Power $\mu$ P Supervisory Circuits with Battery Backup

## Pin Configurations (continued)



## Typical Operating Circuit



## Chip Information

PROCESS: BiCMOS

## Package Information

For the latest package outline information and land patterns (footprints), go to [www.maxim-ic.com/packages](http://www.maxim-ic.com/packages). Note that a "+", "#", or "-" in the package code indicates RoHS status only. Package drawings may show a different suffix character, but the drawing pertains to the package regardless of RoHS status.

| PACKAGE TYPE | PACKAGE CODE | OUTLINE NO.             | LAND PATTERN NO.        |
|--------------|--------------|-------------------------|-------------------------|
| 6 SOT23      | U6-1         | <a href="#">21-0058</a> | <a href="#">90-0175</a> |

# SOT23, Low-Power $\mu$ P Supervisory Circuits with Battery Backup

## Revision History

| REVISION NUMBER | REVISION DATE | DESCRIPTION                                 | PAGES CHANGED |
|-----------------|---------------|---|---------------|
| 0               | 1/00          | Initial release                             | —             |
| 3               | 11/05         | Added lead-free information.                | 1             |
| 4               | 10/11         | Updated <i>Electrical Characteristics</i> . | 2             |

MAX6361-MAX6364

Maxim cannot assume responsibility for use of any circuitry other than circuitry entirely embodied in a Maxim product. No circuit patent licenses are implied. Maxim reserves the right to change the circuitry and specifications without notice at any time. The parametric values (min and max limits) shown in the Electrical Characteristics table are guaranteed. Other parametric values quoted in this data sheet are provided for guidance.

11 **Maxim Integrated Products, 120 San Gabriel Drive, Sunnyvale, CA 94086 408-737-7600**

## Looking for pricing, stock, or lifecycle information?

Click below to explore more details on WIN SOURCE:

- ⊖ [View MAX6364LUT46+T on WIN SOURCE](#)
- ⊖ [Maxim Integrated Information](#)

## Optimize Your Supply Chain with WIN SOURCE Solutions

- ✓ Global Sourcing Solution
- ✓ Obsolete Management
- ✓ Cost Control Management
- ✓ Shortage Management
- ✓ Alternative Solution
- ✓ Excess Inventory Management