



**THE DATASHEET OF  
MAX8627ETD+TG51**



# MAX8627

## Low $V_{BATT}$ , 20 $\mu$ A IQ, 1MHz Synchronous Boost Converter with True Shutdown

### General Description

The MAX8627 step-up converter is a high-efficiency, low-quiescent current, synchronous boost converter with True Shutdown™ and inrush current limiting. The MAX8627 generates any boosted output voltage from 3V to 5V from either a 2-cell NiMH/NiCd or a single-cell Li+/Li polymer battery.

Quiescent current is only 20 $\mu$ A (typ), and at light loads the converter pulses only as needed for best efficiency. At higher loads, PWM mode maintains fixed 1MHz operation for lowest noise and ripple.

The MAX8627 includes an internal soft-start to limit inrush current to a maximum of 500mA. Additional features include True Shutdown, internal compensation, and adjustable current limit. The MAX8627 is available in a tiny 3mm x 3mm TDFN package and is ideal for use in handheld devices such as DSCs, PDAs, and smartphones.

### Applications

DSC Motors and Backup Power  
 Microprocessor/DSP Core Power  
 Cellphones, PDAs, MP3 Players  
 Portable Handheld Devices

Visit [www.maximintegrated.com/products/patents](http://www.maximintegrated.com/products/patents) for product patent marking information.

True Shutdown is a trademark of Maxim Integrated Products, Inc.

### Typical Operating Circuit

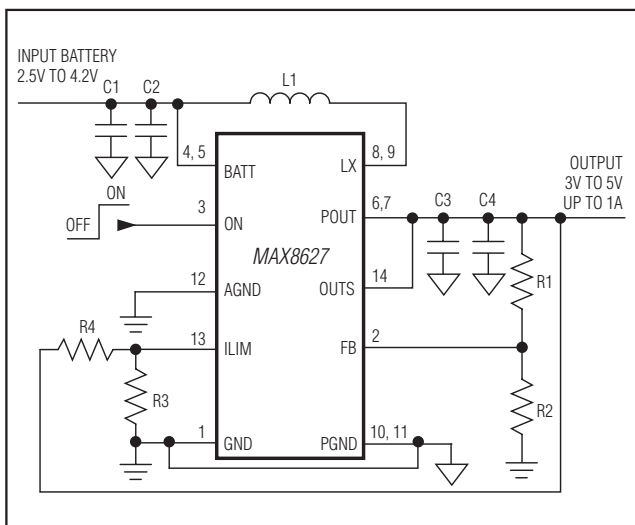

### Features

- ◆ 1MHz PWM Switching Frequency
- ◆ True Shutdown Output
- ◆ Up to 95% Efficiency
- ◆ 1.0A Guaranteed Output Current
- ◆ Soft-Start Eliminates Inrush Current
- ◆ 20 $\mu$ A (typ) Quiescent Current
- ◆ 0.1 $\mu$ A Logic-Controlled Shutdown
- ◆ Internal Synchronous Rectifier
- ◆ Internal Compensation
- ◆ Adjustable Current Limit
- ◆ Low-Noise Antiringing Feature
- ◆ Tiny 14-Pin, 3mm x 3mm, TDFN Package

### Ordering Information

| PART        | PIN-PACKAGE              | PKG CODE | TOP MARK |
|-------------|--------------------------|----------|----------|
| MAX8627ETD+ | 14 TDFN-EP*<br>3mm x 3mm | T1433-2  | AAQ      |

**Note:** The device operates in the -40°C to +85°C extended operating temperature range.

\*EP = Exposed pad.

+Denotes lead-free package.

### Pin Configuration

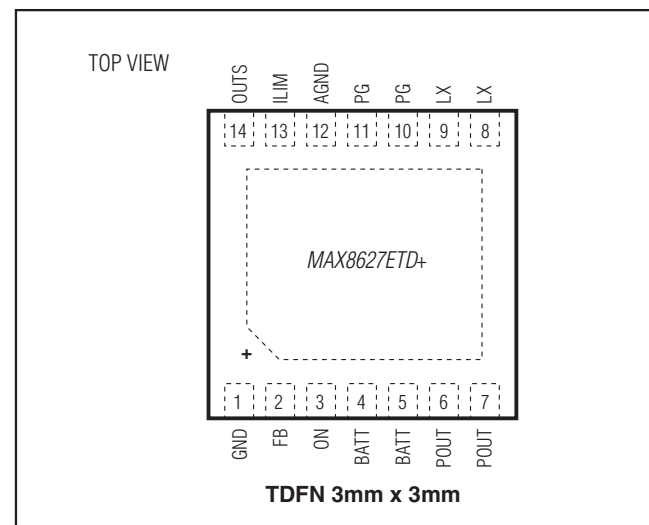

For pricing, delivery, and ordering information, please contact Maxim Direct at 1-888-629-4642, or visit Maxim's website at [www.maximintegrated.com](http://www.maximintegrated.com).

# MAX8627

## Low $V_{BATT}$ , 20 $\mu$ A IQ, 1MHz Synchronous Boost Converter with True Shutdown

### ABSOLUTE MAXIMUM RATINGS

|                           |   |  |
|---------------------------|---|--|
| OUTS, BATT to GND .....   | -0.3V to +6V  | Continuous Power Dissipation ( $T_A = +70^\circ\text{C}$ )         |
| LX Current (Note 1) ..... | 3.5A  | 14-Pin TDFN 3mm x 3mm  |
| AGND, PG to GND .....     | -0.3V to +0.3V  | (derate 18.2mW/ $^\circ\text{C}$ above $+70^\circ\text{C}$ ) ..... |
| POUT to OUTS .....        | -0.3V to +0.3V  | 1454mW   |
| FB, ILIM, ON to           |   | Operating Temperature Range .....                                  |
| GND.....                  | 0.3V to the higher of ( $V_{OUTS} + 0.3\text{V}$ ) and ( $V_{BATT} + 0.3\text{V}$ ) | -40 $^\circ\text{C}$ to +85 $^\circ\text{C}$                       |
|                           |   | Junction Temperature .....   |
|                           |   | +150 $^\circ\text{C}$  |
|                           |   | Storage Temperature Range .....                                    |
|                           |   | -65 $^\circ\text{C}$ to +150 $^\circ\text{C}$                      |
|                           |   | Lead Temperature (soldering, 10s) .....                            |
|                           |   | +300 $^\circ\text{C}$  |

**Note 1:** LX has internal clamp diodes to the IC internal power node  $V_{PWR}$  (where  $V_{PWR}$  is the higher of BATT or POUT) and PG. Applications that forward bias these diodes should take care not to exceed the device's power-dissipation limits.

Stresses beyond those listed under "Absolute Maximum Ratings" may cause permanent damage to the device. These are stress ratings only, and functional operation of the device at these or any other conditions beyond those indicated in the operational sections of the specifications is not implied. Exposure to absolute maximum rating conditions for extended periods may affect device reliability.

### ELECTRICAL CHARACTERISTICS

( $V_{OUTS} = V_{POUT} = 5\text{V}$ ,  $V_{ON} = V_{BATT} = 3.6\text{V}$ ,  $V_{ILIM} = \text{GND}$ ,  $T_A = -40^\circ\text{C}$  to  $+85^\circ\text{C}$ , typical values are at  $T_A = +25^\circ\text{C}$ , unless otherwise noted.)

| PARAMETER                     | CONDITIONS   | MIN  | TYP   | MAX   | UNITS         |    |
|-------------------------------|--|--|-------|-------|---------------|----|
| <b>GENERAL</b>                |  |  |       |       |               |    |
| Operating Input Voltage Range | (Note 1)   | 0.9  |       | 5.5   | V             |    |
| Minimum Startup Voltage       | No load (Note 1)   |  | 1.2   | 1.5   | V             |    |
| Maximum Startup Current Limit |  |  | 0.5   |       | A             |    |
| Supply Current                | Shutdown, ON = GND   | $T_A = +25^\circ\text{C}$                      | 0.1   | 1     | $\mu\text{A}$ |    |
|                               |  | $T_A = +85^\circ\text{C}$                      | 0.2   |       |               |    |
|                               | No load, no switching  | $T_A = 0^\circ\text{C}$ to $+85^\circ\text{C}$ | 20    | 30    |               |    |
|                               |  | $T_A = -40^\circ\text{C}$ (Note 2)             | 20    | 35    |               |    |
| No load, switching            |  | 20   |       |       |               |    |
| <b>OSCILLATOR</b>             |  |  |       |       |               |    |
| Switching Frequency           |  | 0.95   | 1.0   | 1.05  | MHz           |    |
| Startup Switching Frequency   |  |  | 2.0   |       | MHz           |    |
| Maximum Duty Cycle            |  | 82.5   | 87.0  |       | %             |    |
| Output Voltage Adjust Range   |  | 3.0  |       | 5.2   | V             |    |
| FB Regulation Voltage         | No load  | 1.005  | 1.015 | 1.025 | V             |    |
| FB Load Regulation            | 0A to 1A output current load step  |  | -30   |       | mV/A          |    |
| FB Line Regulation            | $V_{BATT} = 2.7\text{V}$ to $3\text{V}$ , output current = $0.5\text{A}$   |  | +20   |       | mV            |    |
| FB Input Leakage Current      | $V_{FB} = 1.2\text{V}$ ,<br>$V_{OUTS} = V_{POUT} = V_{BATT} = 5.5\text{V}$ | $T_A = +25^\circ\text{C}$                      | -50   | -10   | +50           | nA |
|                               |  | $T_A = +85^\circ\text{C}$                      |       | -10   |               |    |
| ILIM Dual Mode™ Threshold     | Low level  |  |       | 0.25  | V             |    |
|                               | High level   | 0.45   |       |       |               |    |
| Idle Mode Trip Level          | (Note 3)   |  | 50    |       | mA            |    |
| <b>DC-DC SWITCHES</b>         |  |  |       |       |               |    |
| n-Channel On-Resistance       |  |  | 0.15  | 0.25  | $\Omega$      |    |
| p-Channel On-Resistance       |  |  | 0.15  | 0.25  | $\Omega$      |    |
| Damping Switch On-Resistance  |  |  | 17    | 30    | $\Omega$      |    |
| n-Channel Current limit       | $V_{ILIM} = 0\text{V}$   | 3.2  | 3.5   | 3.7   | A             |    |
|                               | $V_{ILIM} = 0.6\text{V}$   |  | 1.0   |       |               |    |

Dual Mode is a trademark of Maxim Integrated Products, Inc.

# MAX8627

## Low $V_{BATT}$ , 20 $\mu$ A IQ, 1MHz Synchronous Boost Converter with True Shutdown

### ELECTRICAL CHARACTERISTICS (continued)

( $V_{OUTS} = V_{POUT} = 5V$ ,  $V_{ON} = V_{BATT} = 3.6V$ ,  $V_{ILIM} = GND$ ,  $T_A = -40^\circ C$  to  $+85^\circ C$ , typical values are at  $T_A = +25^\circ C$ , unless otherwise noted.)

| PARAMETER                       | CONDITIONS  | MIN                 | TYP  | MAX | UNITS      |
|---------------------------------|---|---------------------|------|-----|------------|
| p-Channel Turn-Off Current      |   |                     | 10   |     | mA         |
| POUT Leakage Current            | $V_{LX} = 0V$ , $V_{POUT} = V_{BATT} = 5.5V$  | $T_A = +25^\circ C$ | 0.1  | 1   | $\mu A$    |
|                                 |   | $T_A = +85^\circ C$ | 0.2  |     |            |
| LX Leakage Current              | $V_{LX} = 0V$ and $V_{POUT} = 5.5V$ or $V_{LX} = 5.5V$ and $V_{OUTS} = V_{POUT} = 0V$ | $T_A = +25^\circ C$ | 0.1  | 1   | $\mu A$    |
|                                 |   | $T_A = +85^\circ C$ | 0.2  |     |            |
| Soft-Start Interval             | Output current = 0.5A   |                     | 5.25 |     | ms         |
| Overload Protection Fault Delay |   |                     | 65   |     | ms         |
| <b>LOGIC INPUTS</b>             |   |                     |      |     |            |
| ON Input Low Level              | $1.5V < V_{POUT} = V_{OUTS} = V_{BATT} \leq 1.8V$                                     |                     |      | 0.2 | V          |
|                                 | $1.8V < V_{POUT} = V_{OUTS} = V_{BATT} \leq 5.5V$                                     |                     |      | 0.5 |            |
| ON Input High Level             | $1.5V < V_{POUT} = V_{OUTS} = V_{BATT} \leq 1.8V$                                     | $V_{POUT} - 0.2$    |      |     | V          |
|                                 | $1.8V < V_{POUT} = V_{OUTS} + V_{BATT} \leq 5.5V$                                     | 1.6                 |      |     |            |
| ON, Input Leakage Current       | $V_{OUTS} = V_{POUT} = V_{BATT} = 5.5V$ ,<br>$ON = 0V$ or $ON = 5.5V$                 | $T_A = +25^\circ C$ | 0.01 | 1   | $\mu A$    |
|                                 |   | $T_A = +85^\circ C$ | 0.02 |     |            |
| Thermal Shutdown                |   |                     | +160 |     | $^\circ C$ |

**Note 1:** The MAX8627 is powered from OUTS. Once started, the IC operates down to 0.9V.

**Note 2:** Specifications to  $-40^\circ C$  are guaranteed by design and not production tested.

**Note 3:** The idle-mode current threshold is the transition point between fixed-frequency PWM operation and idle-mode operation. The specification is given in terms of output load current for an inductor value of  $1\mu H$ . For a step-up converter, the idle-mode transition varies with the input-to-output voltage ratio.

# MAX8627

## Low $V_{BATT}$ , 20 $\mu$ A $I_Q$ , 1MHz Synchronous Boost Converter with True Shutdown

### Typical Operating Characteristics

(Circuit of Figure 1,  $V_{OUTS} = V_{POUT} = 5V$ ,  $V_{ON} = V_{BATT} = 3.6V$ ,  $T_A = +25^\circ C$ , unless otherwise noted.)

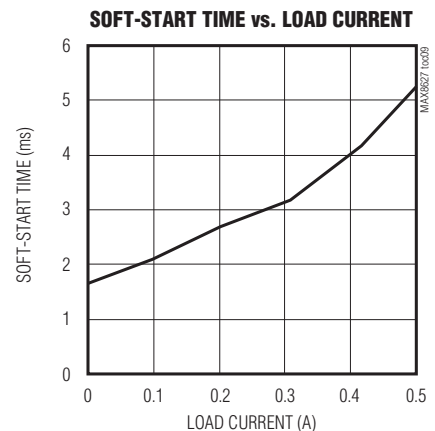
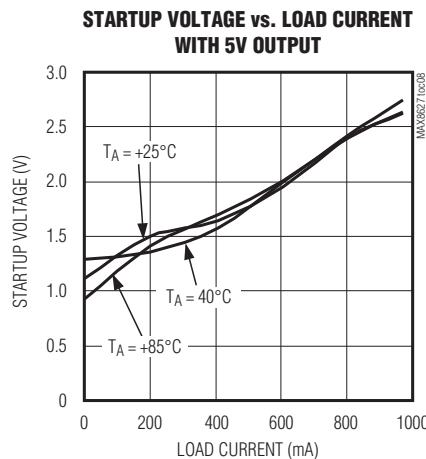
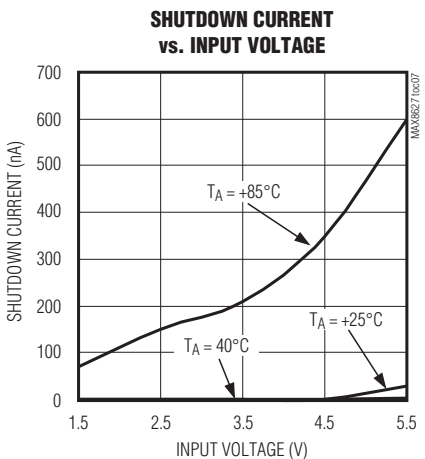
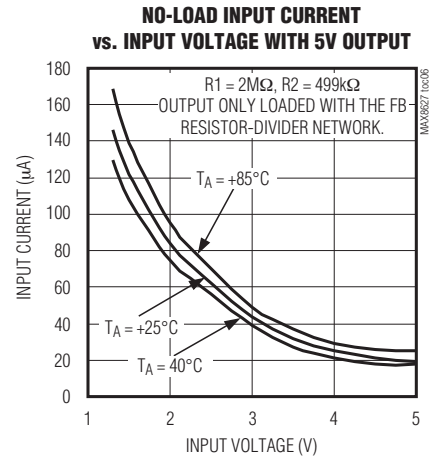
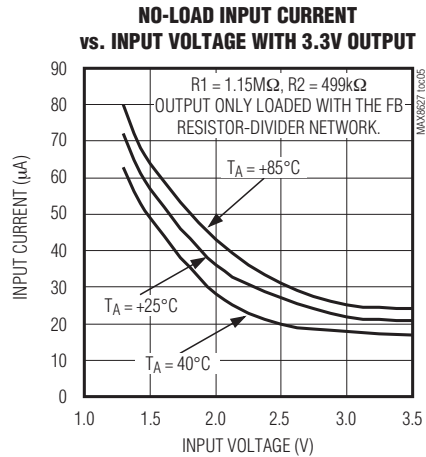
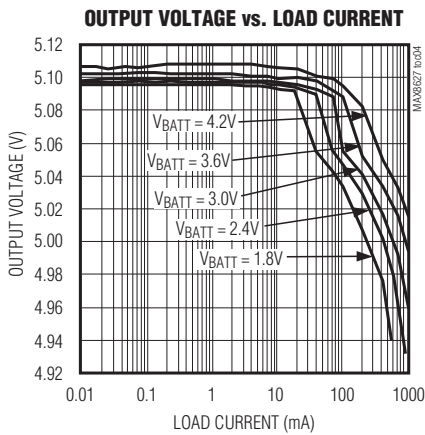
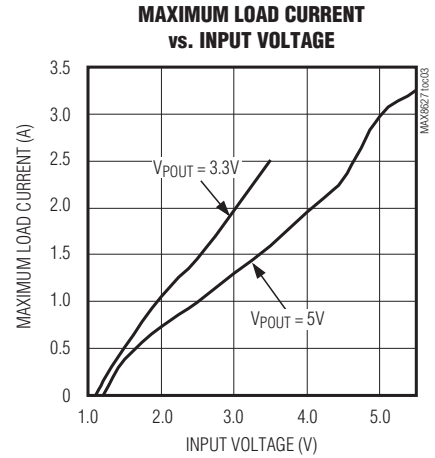
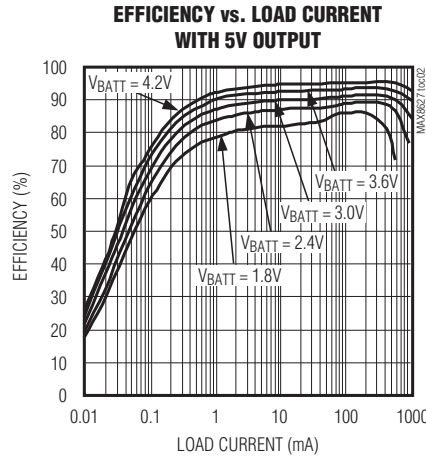
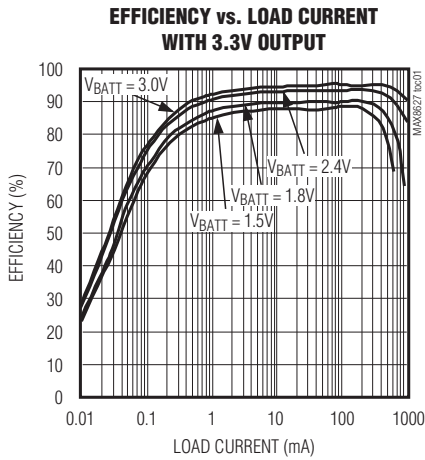

# MAX8627

## Low $V_{BATT}$ , 20 $\mu$ A IQ, 1MHz Synchronous Boost Converter with True Shutdown

### Typical Operating Characteristics (continued)

(Circuit of Figure 1,  $V_{OUTS} = V_{POUT} = 5V$ ,  $V_{ON} = V_{BATT} = 3.6V$ ,  $T_A = +25^\circ C$ , unless otherwise noted.)

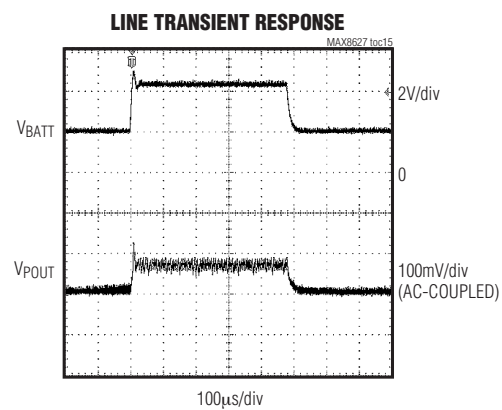
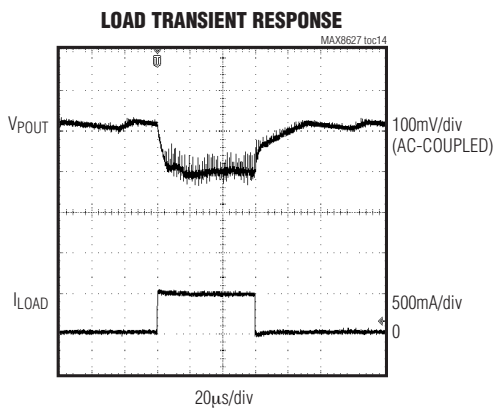
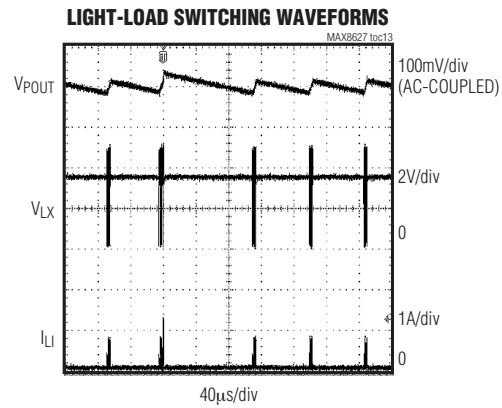
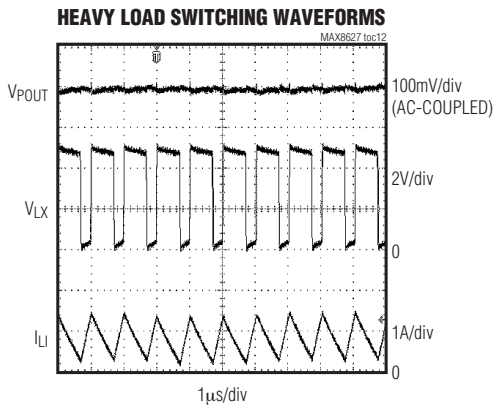
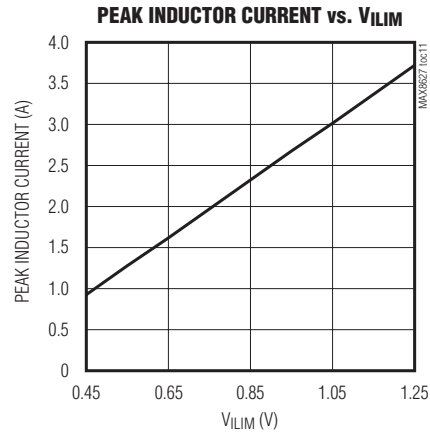
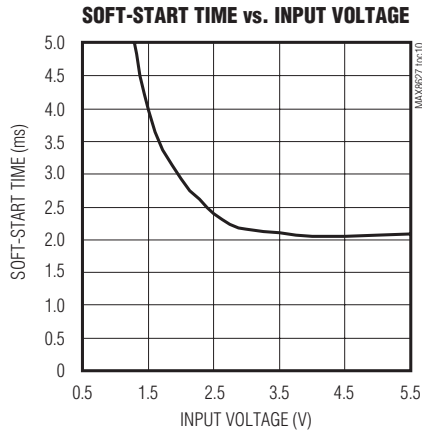

# MAX8627

## Low $V_{BATT}$ , $20\mu A$ IQ, 1MHz Synchronous Boost Converter with True Shutdown

### Typical Operating Characteristics (continued)

(Circuit of Figure 1,  $V_{OUTS} = V_{POUT} = 5V$ ,  $V_{ON} = V_{BATT} = 3.6V$ ,  $T_A = +25^\circ C$ , unless otherwise noted.)

STARTUP WAVEFORMS WITH NO LOAD

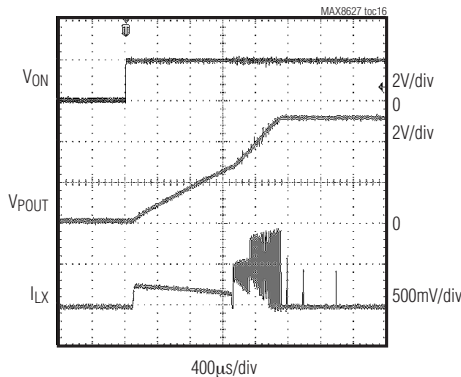

STARTUP WAVEFORMS WITH 100mA LOAD

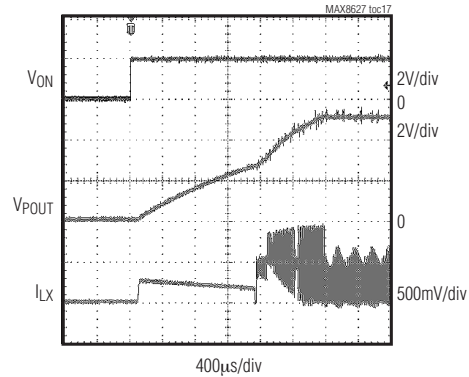

SWITCHING FREQUENCY vs. TEMPERATURE

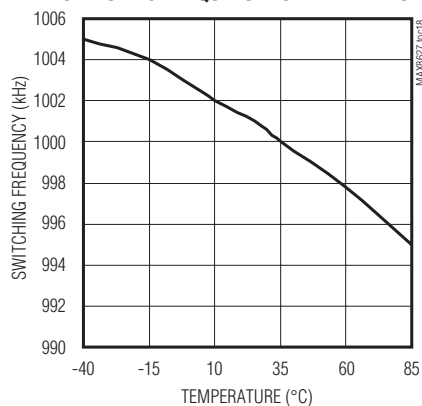

BODE PLOT WITH 2 x 22µF CERAMIC OUTPUT CAPACITORS, 500mA LOAD

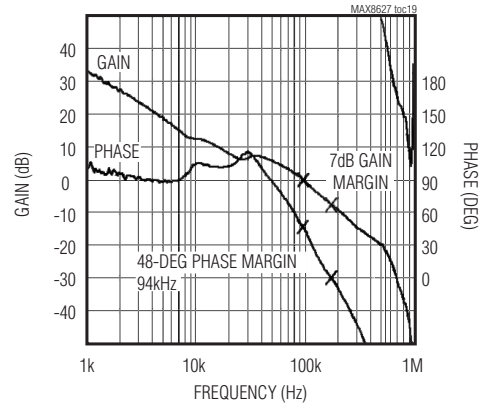

BODE PLOT WITH 2 x 47µF TANTALUM OUTPUT CAPACITORS (130mΩ ESR), 500mA LOAD

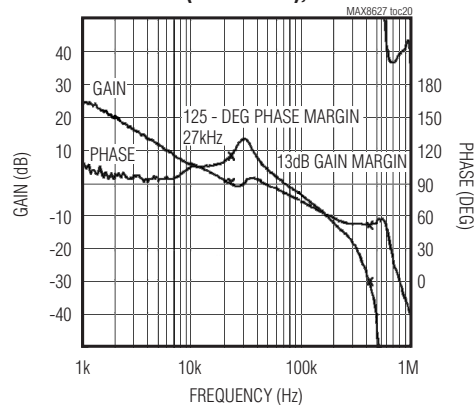

# MAX8627

## Low $V_{BATT}$ , 20 $\mu$ A IQ, 1MHz Synchronous Boost Converter with True Shutdown

### Pin Description

| PIN    | NAME | FUNCTION   |
|--------|------|--|
| 1      | GND  | Analog Ground. Connect to PG and AGND.   |
| 2      | FB   | Voltage Feedback Input. Connect FB to the center of an external feedback network between OUTS and GND (see the <i>Setting the Output Voltage</i> section). FB regulates to 1.015V (typ).   |
| 3      | ON   | Active-High Enable Input. Connect ON to BATT or logic high for normal operation. Connect ON to GND or logic low for True Shutdown mode.  |
| 4, 5   | BATT | Supply Voltage Input. Connect to the battery or a supply from 1.5V to 5.5V. Connect two 22 $\mu$ F ceramic capacitors from BATT to PG.   |
| 6, 7   | POUT | Power Output. Connect two 22 $\mu$ F ceramic capacitors from POUT to PG (see the <i>Capacitor Selection</i> section).  |
| 8, 9   | LX   | Inductor Connection. LX is high impedance in shutdown.   |
| 10, 11 | PG   | Power Ground. Connect to GND and AGND.   |
| 12     | AGND | Analog Ground. Connect to GND and PG.  |
| 13     | ILIM | n-Channel Current-Limit Control. For the maximum current limit of 3.5A, connect ILIM to GND. For lower current-limit settings, connect ILIM to a resistor-divider from POUT to GND (see the <i>Setting the Current Limit</i> section). |
| 14     | OUTS | IC Power Input. Supplied from the output. Connect OUTS to POUT.  |
| —      | EP   | Exposed Pad. Connect EP to GND. This does not remove the requirement for a proper ground connection to GND.  |



## Low $V_{BATT}$ , 20 $\mu$ A IQ, 1MHz Synchronous Boost Converter with True Shutdown

### **Detailed Description**

The MAX8627 is a current-mode step-up converter that uses a fixed-frequency PWM architecture with True Shutdown. Consuming only 20 $\mu$ A of quiescent current, the MAX8627 is highly efficient, with an internal switch and synchronous rectifier. Shutdown reduces the quiescent current to less than 1 $\mu$ A. Low quiescent current and low noise make this device ideal for powering portable equipment.

The MAX8627 step-up DC-to-DC switching converter typically generates a 3V to 5V output voltage from a 1.5V to 4.2V battery input voltage. The IC operates in bootstrapped mode with the output powering the IC once the output voltage is equal to, or exceeds, 2.7V. The default current limit is set at 3.5A to deliver 1A at 5V with an Li+ battery, or 500mA at 5V using a 2-cell NiCd/NiMH battery. The current limit may be lowered using an external resistor at ILIM to allow for smaller components in lower power applications. Internal soft-start limits the inrush current to less than 500mA under no-load conditions during startup.

The MAX8627 switches at an internally set frequency of 1MHz allowing for tiny external components. Internal compensation further reduces the external component count in cost and space-sensitive applications. The MAX8627 is optimized for use in DSC and other applications requiring low quiescent current for maximum battery life. Figure 1 shows the typical applications circuit. Figure 2 gives the functional diagram.

### **DC-DC Converter**

The MAX8627 uses a current-mode PWM control scheme. The voltage difference between FB and an internal 1.01V reference generates an error signal that programs the peak inductor current to regulate the output voltage. The default peak inductor current limit is typically 3.5A. Inductor current is sensed across the internal switch and summed with a slope-compensation signal. The PWM comparator compares this summed signal to the error amplifier output. At the beginning of each clock cycle, the n-channel switch turns on until the PWM comparator trips. During this time, inductor current ramps up, storing energy in its magnetic field. When the n-channel switch turns off, the internal synchronous p-channel rectifier turns on. The inductor releases the stored energy as the current ramps down and provides energy to the output.

The device operates in PWM when driving medium to heavy loads. As the load current decreases and crosses the low-power idle mode threshold, the PWM comparator and oscillator are disabled. In this low-power idle mode, switching occurs only as needed to service the output. This improves the efficiency for light loads and the IC consumes only 20 $\mu$ A under no-load conditions. At light loads, the output ripple has a frequency component that varies with load current. The threshold for entering the low-power mode is determined by sensing the voltage drop across the internal switch and comparing it to an internally generated reference level. This threshold is approximately 50mA with a 3.6V input and 5V output.

When switching in low-power mode, the inductor current terminates at zero for each switching cycle. When operating in this manner, the inductor current is called discontinuous. In older DC-DC converters, radiated noise may be higher when inductor current is discontinuous, because of ringing at the LX switch. The MAX8627 features an internal damping switch to minimize ringing at LX when inductor current is discontinuous. The damping switch places an impedance across the inductor and supplies a path to dissipate the resonant energy in the inductor and capacitor to damp the ringing at the LX. The damping switch has little effect on output voltage ripple but does reduce EMI.

At higher loads, the MAX8627 operates in PWM mode. Regulation is achieved by modulating the MOSFET switch pulse to control the amount of power transferred per cycle. Switching harmonics generated by fixed-frequency operation are consistent and easily filtered. This is important in noise-sensitive applications.

### **Load-Transient Response/Voltage Positioning**

The MAX8627 matches the load regulation to the voltage droop seen during load transients. This is sometimes called voltage positioning. Benefits include lower peak-to-peak output-voltage deviation for a given load step without requiring an increase in filter load capacitance. There is minimal voltage droop when transitioning from a light load to full load and minimum overshoot when going from full load to light load.

# MAX8627

## Low $V_{BATT}$ , $20\mu A$ $I_Q$ , 1MHz Synchronous Boost Converter with True Shutdown

The term “positioning” refers to setting the output voltage to a level that is dependent on load current (see Figure 3). At minimum load, the output voltage is set to a slightly higher than nominal level. At full load, the output voltage is slightly lower than the nominal level. With voltage positioning, the total voltage deviation during a transient is significantly improved over traditional high-gain control loops. Traditional high-gain loops use integrators that maximize gain at low frequencies to provide tight DC-load regulation; however, due to the capacitive element in the feedback loop, these high-gain amplifiers typically take hundreds of microseconds to respond to a load step and return to steady state. As a result, the voltage can droop by as much as 6% or more during the recovery time. In portable equipment where the output load can change frequently, and the amount of output capacitance that can fit is limited, this can result in a wide short-term output fluctuation (see Figure 4).

Voltage positioning on the MAX8627 allows up to 3% (typ) of load regulation and no further transient droop (Figures 3 and 4). Thus, during load transients the voltage delivered remains within specification more effectively than other regulators that might have tighter DC accuracy. In systems with high-speed CPUs, thousands of system clock cycles can occur during the time it takes a traditional high-gain loop to respond to a load step. Consequently, 3% load regulation with no transient droop is better suited to such systems than a power supply that may spec 1% DC load regulation, but then exhibits 6% or more of transient droop during load steps (see the Load Transient Response in the *Typical Operating Characteristics* section).

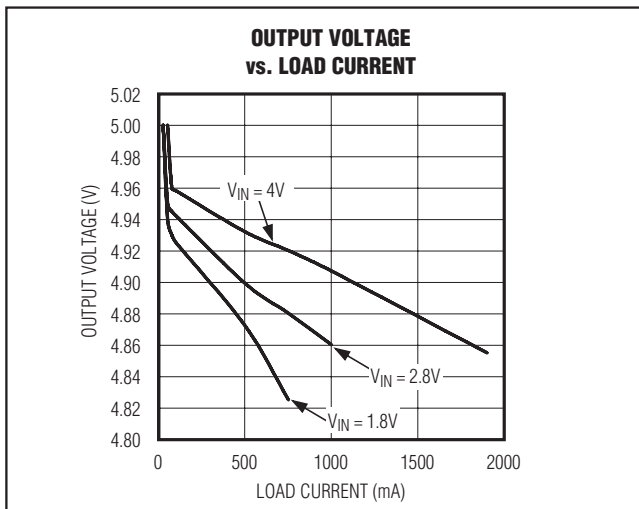

Figure 3. Load-Regulation Specification

### True Shutdown

Connecting ON to GND or logic low places the MAX8627 in shutdown mode and reduces supply current to  $0.1\mu A$ . In shutdown, the control circuitry, internal switching MOSFET, and synchronous rectifier turn off and LX becomes high impedance. Connect ON to BATT or logic high for normal operation.

The MAX8627 has an internal synchronous rectifier, which allows for conversion efficiencies as high as 95%. In conventional boost circuits, the body diode of the synchronous rectifier is forward biased in shutdown and allows current flow from the battery to the output. If the load cannot be shut down, an external switch is required to avoid depleting the battery during shutdown. A proprietary design in the MAX8627 allows the synchronous rectifier to provide True Shutdown with no additional components. This allows the output to fall to GND in shutdown and removes any connection between the input and output.

### Soft-Start

The MAX8627 has internal soft-start circuitry that eliminates inrush current at startup, reducing transients on the input source. Soft-start is particularly useful for higher impedance input sources, such as Li+ and alkaline cells. The soft-start duration is proportional to the size of the output capacitor and load resistance with a typical time of 5.25ms. See the *Typical Operating Characteristics* section for plots of Soft-Start Time vs. Load Current and Soft-Start Time vs. Input Voltage. Inrush current is controlled during startup and initially set to 500mA. After 1000 clock cycles, if the output voltage is not within regulation, the startup current limit is

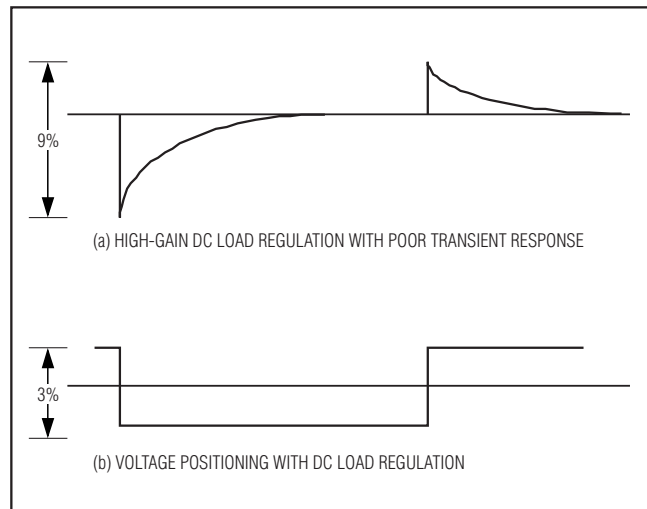

Figure 4. Transient-Response Comparison

# MAX8627

## Low $V_{BATT}$ , 20 $\mu$ A IQ, 1MHz Synchronous Boost Converter with True Shutdown

incremented by 230mA. If after 13 increments, the output is still not in regulation, the MAX8627 latches off, assuming a short-circuit overload condition exists on the output. To clear the latched condition, cycle ON.

### Fault Protection

The MAX8627 has a fault-overload protection. After soft-start, the device is set to detect an out-of-regulation state that could be caused by an overload. If the output remains faulted for 65ms, then the MAX8627 latches off. Fault-detection circuitry is disabled during soft-start. If short on the output exists before the MAX8627 is turned ON, the converter completes the soft-start sequence and latches off. The converter can be reinitialized from a fault latch-off state by toggling the ON pin or by cycling the input power.

### BATT/Damping Switch

The MAX8627 features an internal damping switch to minimize ringing at LX caused by the resonant circuit formed by the inductor and output capacitor in discontinuous conduction mode. This occurs at light loads. The damping switch connects across the inductor when the inductor energy is depleted and supplies a path to dissipate the resonant energy. Damping LX ringing does not change the output ripple but reduces EMI.

## Applications Information

### Setting the Output Voltage

To set the output voltage to between 3V and 5V, connect FB to the center of an external resistor voltage-divider between OUTS and GND, as shown in Figure 1. Select the value of R2 less than 500k $\Omega$ , and then calculate the value for R1 as follows:

$$R1 = R2 \times \left( \frac{V_{OUT}}{V_{FB}} - 1 \right)$$

where  $V_{FB}$  is the FB regulation voltage, 1.015V (typ).

### Inductor Selection

In most step-up converter designs, a reasonable inductor value can be derived from the following equation,

which sets peak-to-peak inductor current at 1/2 the DC inductor current:

$$L = \frac{2 \times V_{BATT} \times D \times (1-D)}{I_{OUT(MAX)} \times f_{SW}}$$

where  $f_{SW}$  is the switching frequency (1MHz), and D is the duty factor given by  $D = 1 - (V_{BATT} / V_{OUT})$ .

Using L from the equation above results in a peak-to-peak inductor current ripple of  $0.5 \times I_{OUT} / (1 - D)$ , and a peak inductor current of  $1.25 \times I_{OUT} / (1 - D)$ . Ensure the peak (saturation) current rating of the inductor meets or exceeds this requirement.

The recommended inductance range for the MAX8627 is 1 $\mu$ H to 4.7 $\mu$ H. See Table 1 for recommended inductors.

### Capacitor Selection

#### Output Capacitor

Output capacitors C3 and C4 in Figure 1 are required to keep the output voltage ripple small and to ensure regulation loop stability. The output capacitors must have low impedance at the switching frequency. Ceramic capacitors are highly recommended due to their small size and low ESR. Make sure the output capacitors maintain their capacitance over DC bias and the desired operating temperature range. Ceramic capacitors with X5R or X7R temperature characteristics generally perform well. Two 22 $\mu$ F ceramic capacitors in parallel are recommended. Alternatively, two 47 $\mu$ F tantalum capacitors with 70m $\Omega$  or lower ESR may be used.

#### Input Capacitor

Input capacitors C1 and C2 reduce the current peaks drawn from the battery or input power source and reduce switching noise in the IC. The impedance of the input capacitors at the switching frequency should be kept very low. Ceramic capacitors are highly recommended due to their small size and low ESR. Make sure the input capacitors maintain their capacitance over DC bias and the desired operating temperature range. Ceramic capacitors with X5R or X7R temperature characteristics generally perform well. Two 22 $\mu$ F ceramic capacitors are recommended.

Table 1. Recommended Inductors

| PART        | INDUCTANCE ( $\mu$ H) | RATED CURRENT (mA) | SIZE:<br>L (mm, typ) x W (mm, typ) x H (mm, max) |
|-------------|-----------------------|--------------------|--|
| TOKO A918CY | 1.0                   | 3500               | 6.3 x 6.2 x 2                                    |
| TOKO A997AS | 1.5                   | 2150               | 3.8 x 3.8 x 1.8                                  |

# MAX8627

## Low $V_{BATT}$ , 20 $\mu$ A IQ, 1MHz Synchronous Boost Converter with True Shutdown

### Setting the Current Limit

ILIM sets the current limit when the output reaches regulation. It is different from the startup current limit used during soft-start to control inrush current. For the maximum current limit of 3.5A, connect ILIM to GND. To set the current limit ( $I_{LIM}$ ) lower than 3.5A, connect ILIM to a resistor-divider from POUT to GND as shown in Figure 1. Note, however, that the idle-mode threshold does not change with voltage setting on ILIM.

Set R3 between 30k $\Omega$  and 300k $\Omega$ , then calculate the value of R4 as follows:

$$R4 = R3 \times \left( \frac{V_{POUT}}{(I_{LIM} + 0.64A) \times 0.2865\Omega} - 1 \right)$$

### PC Board Layout and Routing

Good PC board layout is important to achieve optimal performance from the MAX8627. Poor design can cause excessive conducted and/or radiated noise. Conductors carrying discontinuous currents and any high-current path should be made as short and wide as possible. Keep the feedback network (R1 and R2) very close to the IC, preferably within 0.2in of the FB and GND pins. Nodes with high dV/dt (switching nodes) should be kept as small as possible and routed away from FB. Connect the input and output capacitors as close as possible to the IC. Refer to the MAX8627 evaluation kit for a PC board layout example.

### Chip Information

PROCESS: BiCMOS

# MAX8627

## Low $V_{BATT}$ , 20 $\mu$ A IQ, 1MHz Synchronous Boost Converter with True Shutdown

### Package Information

For the latest package outline information and land patterns (footprints), go to [www.maximintegrated.com/packages](http://www.maximintegrated.com/packages). Note that a "+", "#", or "-" in the package code indicates RoHS status only. Package drawings may show a different suffix character, but the drawing pertains to the package regardless of RoHS status.

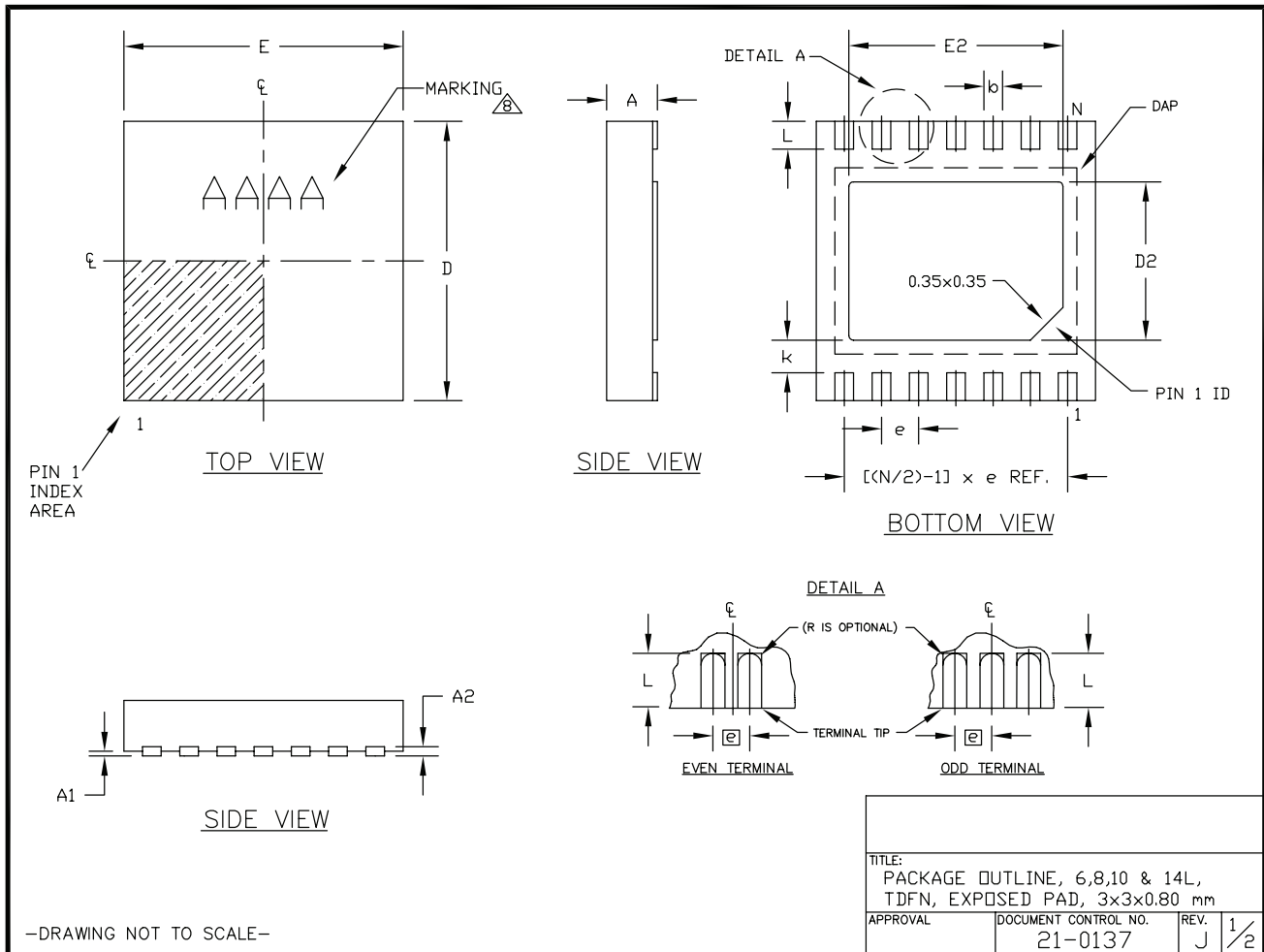



## Looking for pricing, stock, or lifecycle information?

Click below to explore more details on WIN SOURCE:

- ⊖ [View MAX8627ETD+TG51 on WIN SOURCE](#)
- ⊖ [Maxim Integrated Information](#)

## Optimize Your Supply Chain with WIN SOURCE Solutions

- ✓ Global Sourcing Solution
- ✓ Obsolete Management
- ✓ Cost Control Management
- ✓ Shortage Management
- ✓ Alternative Solution
- ✓ Excess Inventory Management