



**THE DATASHEET OF  
MAX98306ETD+T**



## MAX98306

## Stereo 3.7W Class D Amplifier

### General Description

The MAX98306 stereo 3.7W Class D amplifier provides Class AB audio performance with Class D efficiency. This device offers five selectable gain settings (6dB, 9dB, 12dB, 15dB, and 18dB) set by a single gain-select input (GAIN).

Active emissions limiting, edge-rate, and overshoot control circuitry combined with a filterless spread-spectrum modulation scheme (SSM) provide excellent EMI performance while eliminating the need for output filtering found in traditional Class D devices. These features reduce application component count.

The IC's 2.0mA quiescent current with a 3.7V supply extends battery life in portable applications.

The IC is available in a 14-pin TDFN (3mm x 3mm x 0.75mm) package specified over the extended -40°C to +85°C temperature range.

### Applications

- Smartphones
- Tablets
- Cellular Phones
- Accessory Speakers
- MP3 Players
- Portable Audio Players
- VoIP Phones

### Features

- Output Power 3.7W at 3Ω, 10% THD, 1.7W at 8Ω, 10% THD, with 5V Supply
- Passes EMI Limit Unfiltered with Up to 12in of Speaker Cable
- High 83dB PSRR at 217Hz
- Spread-Spectrum Modulation and Active Emissions Limiting
- Five Pin-Selectable Gains
- Excellent Click-and-Pop Suppression
- Thermal and Overcurrent Protection
- Low-Current Shutdown Mode
- Space-Saving, 3mm x 3mm x 0.75mm, 14-Pin TDFN

### Ordering Information

PART	TEMP RANGE	PIN-PACKAGE	TOP MARK
MAX98306ETD+	-40°C to +85°C	14 TDFN	+AEV

+Denotes a lead(Pb)-free/RoHS-compliant package.

### Typical Application Circuit

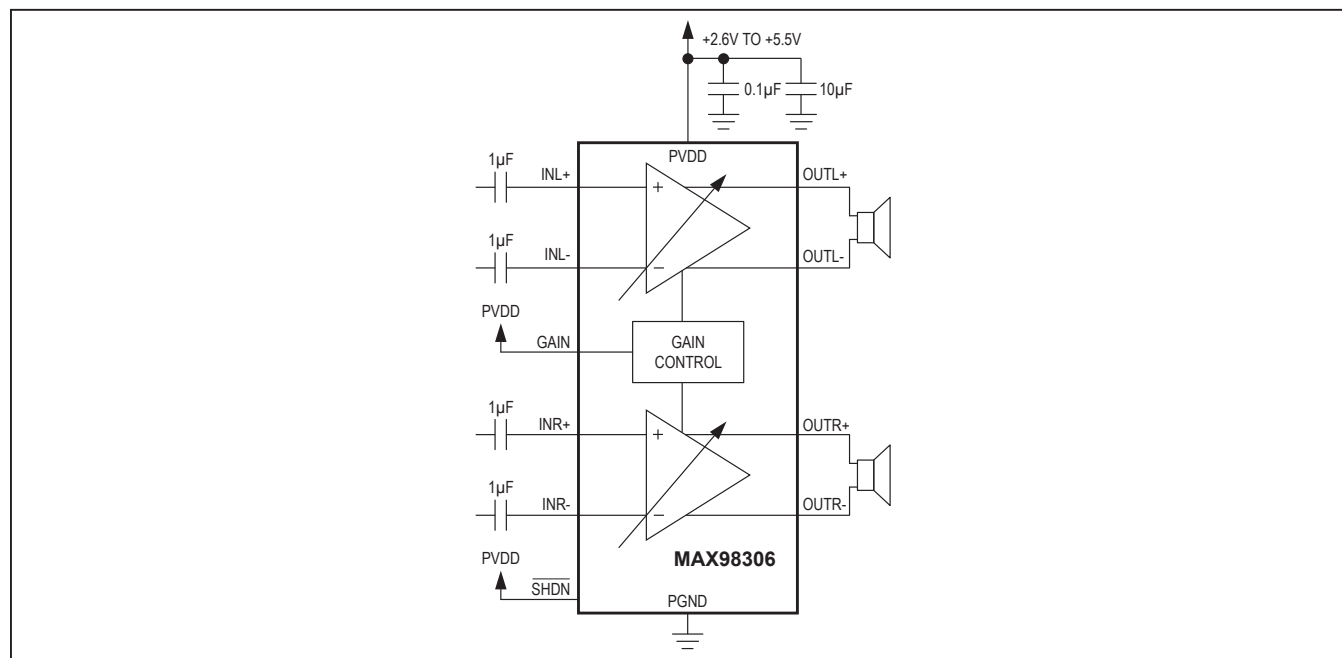

### Absolute Maximum Ratings

<p><b>Voltage</b>                  PVDD to PGND .....-0.3V to +6V                  OUTL+, OTR+, OUTL-, OTR-                  to PGND .....-0.3V to (V<sub>PVDD</sub> + 0.3V)                  All Other Pins to PGND .....-0.3V to +6V</p> <p><b>Current</b>                  Continuous Current Into/Out of PVDD, PGND,                  OUTL+, OTR+, OUTL-, OTR- .....±800mA                  Continuous Input Current (all other pins) .....±20mA</p>	<p><b>Duration of Short Circuit</b>                  OUTL+, OTR+, OUTL-,                  OTR- to PGND or PVDD ..... Continuous                  OUTL+ to OUTL- or OTR+ to OTR- ..... Continuous</p> <p><b>Continuous Power Dissipation for a MultiLayer Board (T<sub>A</sub> = +70°C)</b>                  TDFN (deration 24.4mW/°C above +70°C) ..... 1951.2mW</p> <p><b>Junction Temperature</b> ..... +150°C  <b>Operating Temperature Range</b> ..... -40°C to +85°C  <b>Storage Temperature Range</b> ..... -65°C to +150°C  <b>Lead Temperature (10s, soldering)</b> ..... +300°C  <b>Soldering Temperature (reflow)</b> ..... +260°C</p>
--	--

Stresses beyond those listed under "Absolute Maximum Ratings" may cause permanent damage to the device. These are stress ratings only, and functional operation of the device at these or any other conditions beyond those indicated in the operational sections of the specifications is not implied. Exposure to absolute maximum rating conditions for extended periods may affect device reliability.

### Package Thermal Characteristics (Note 1)

Junction-to-Ambient Thermal Resistance (θ <sub>JA</sub> ) .....41°C/W
Junction-to-Case Thermal Resistance (θ <sub>JC</sub> ) .....8°C/W

**Note 1:** Package thermal resistances were obtained using the method described in JEDEC specification JESD51-7, using a four-layer board. For detailed information on package thermal considerations, refer to [www.maximintegrated.com/thermal-tutorial](http://www.maximintegrated.com/thermal-tutorial).

### Electrical Characteristics

(V<sub>PVDD</sub> = V<sub>SHDN</sub> = 3.7V, V<sub>PGND</sub> = 0V, A<sub>V</sub> = 12dB (GAIN = PVDD), R<sub>L</sub> = ∞, R<sub>L</sub> connected between OUT<sub>+</sub> to OUT<sub>-</sub>, 20Hz to 22kHz AC measurement bandwidth, T<sub>A</sub> = T<sub>MIN</sub> to T<sub>MAX</sub>, unless otherwise noted. Typical values are at T<sub>A</sub> = +25°C.) (Note 2)

PARAMETER	SYMBOL	CONDITIONS	MIN	TYP	MAX	UNITS
<b>GENERAL</b>						
Supply Voltage Range	V <sub>PVDD</sub>	Guaranteed by PSRR test	2.6		5.5	V
Undervoltage Lockout	UVLO			1.8	2.3	V
Quiescent Supply Current	I <sub>PVDD</sub>	V <sub>PVDD</sub> = 3.7V		2	2.7	mA
		V <sub>PVDD</sub> = 5.0V		2.6		
Shutdown Supply Current	I <sub>SHDN</sub>	V <sub>SHDN</sub> = 0, T <sub>A</sub> = +25°C		< 1	10	µA
Turn On Time	t <sub>ON</sub>			3.2	10	ms
Bias Voltage	V <sub>BIAS</sub>		1.62	V <sub>PVDD</sub> /2	2.15	V
Voltage Gain	A <sub>V</sub>	GAIN = PGND	17.5	18	18.5	dB
		GAIN = 100kΩ to PGND	14.5	15	15.5	
		GAIN = PVDD	11.5	12	12.5	
		GAIN = 100kΩ to PVDD	8.5	9	9.5	
		GAIN = unconnected	5.5	6	6.5	
Channel-to-Channel Gain Tracking				0.1		%
Input Resistance	R <sub>IN</sub>	A <sub>V</sub> = 18dB (GAIN = PGND)	22	33		kΩ
		A <sub>V</sub> = 15dB (GAIN = 100kΩ to PGND)	31	46		
		A <sub>V</sub> = 12dB (GAIN = PVDD)	44	65		
		A <sub>V</sub> = 9dB (GAIN = 100kΩ to PVDD)	62	93		
		A <sub>V</sub> = 6dB (GAIN = unconnected)	89	131		
Common-Mode Rejection Ratio	CMRR	f <sub>IN</sub> = 1kHz, input referred		79		dB
Output Offset Voltage	V <sub>OS</sub>	T <sub>A</sub> = +25°C (Note 3)		±1	±3	mV

**Electrical Characteristics (continued)**

( $V_{PVDD} = V_{SHDN} = 3.7V$ ,  $V_{PGND} = 0V$ ,  $A_V = 12dB$  (GAIN = PVDD),  $R_L = \infty$ ,  $R_L$  connected between  $OUT_+$  to  $OUT_-$ , 20Hz to 22kHz AC measurement bandwidth,  $T_A = T_{MIN}$  to  $T_{MAX}$ , unless otherwise noted. Typical values are at  $T_A = +25^\circ C$ .) (Note 2)

PARAMETER	SYMBOL	CONDITIONS		MIN	TYP	MAX	UNITS
Click-and-Pop Level	$K_{CP}$	Peak voltage, $T_A = +25^\circ C$ A-weighted, 32 samples per second (Notes 3, 4)	Into shutdown		-79		dBV
			Out of shutdown		-73		
Power-Supply Rejection Ratio	PSRR	$T_A = +25^\circ C$ (Note 3)	$V_{PVDD} = 2.6V$ to $5.5V$ , $T_A = +25^\circ C$	70	95		dB
			$f = 217Hz$ , $200mV_{P-P}$ ripple		83		
			$f = 1kHz$ , $200mV_{P-P}$ ripple		83		
			$f = 10kHz$ , $200mV_{P-P}$ ripple		77		
Output Power	$P_{OUT}$	THD+N = 10%	$Z_{SPK} = 3\Omega + 22\mu H$ , $V_{PVDD} = 5.0V$		3.7		W
			$Z_{SPK} = 4\Omega + 33\mu H$ , $V_{PVDD} = 5.0V$		3		
			$Z_{SPK} = 8\Omega + 68\mu H$ , $V_{PVDD} = 5.0V$		1.7		
			$Z_{SPK} = 8\Omega + 68\mu H$ , $V_{PVDD} = 3.7V$		0.9		
		THD+N = 1%	$Z_{SPK} = 3\Omega + 22\mu H$ , $V_{PVDD} = 5.0V$		2.9		
			$Z_{SPK} = 4\Omega + 33\mu H$ , $V_{PVDD} = 5.0V$		2.4		
			$Z_{SPK} = 8\Omega + 68\mu H$ , $V_{PVDD} = 5.0V$		1.4		
			$Z_{SPK} = 8\Omega + 68\mu H$ , $V_{PVDD} = 3.7V$		0.75		
Total Harmonic Distortion Plus Noise	THD+N	$f_{IN} = 1kHz$ $T_A = +25^\circ C$	$Z_{SPK} = 3\Omega + 22\mu H$ , $P_{OUT} = 1.6W$ , $P_{VDD} = 5.0V$		0.05		%
			$Z_{SPK} = 4\Omega + 33\mu H$ , $P_{OUT} = 650mW$ , $P_{VDD} = 3.7V$		0.05	0.75	
			$Z_{SPK} = 4\Omega + 33\mu H$ , $P_{OUT} = 1.3W$ , $V_{PVDD} = 5.0V$		0.04		
			$Z_{SPK} = 8\Omega + 68\mu H$ , $P_{OUT} = 725mW$ , $P_{VDD} = 5.0V$		0.03		
Output Noise		A-weighted (Note 3)		29		$\mu V_{RMS}$	

**Electrical Characteristics (continued)**

( $V_{PVDD} = V_{SHDN} = 3.7V$ ,  $V_{PGND} = 0V$ ,  $A_V = 12dB$  (GAIN = PVDD),  $R_L = \infty$ ,  $R_L$  connected between  $OUT_+$  to  $OUT_-$ , 20Hz to 22kHz AC measurement bandwidth,  $T_A = T_{MIN}$  to  $T_{MAX}$ , unless otherwise noted. Typical values are at  $T_A = +25^\circ C$ .) (Note 2)

PARAMETER	SYMBOL	CONDITIONS	MIN	TYP	MAX	UNITS
Signal-to-Noise Ratio	SNR	$Z_{SPK} = 8\Omega + 68\mu H$ , $P_{OUT}$ at 1% THD+N		99		dB
Efficiency	$\eta$	$Z_{SPK} = 8\Omega + 68\mu H$ , $P_{OUT} = 1.4W$ , $f = 1kHz$		92		%
Oscillator Frequency	$f_{OSC}$		160	320	540	kHz
Spread-Spectrum Bandwidth				20		kHz
Current Limit		$T_A = +25^\circ C$		3		A
Thermal-Shutdown Level				+150		$^\circ C$
Thermal Hysteresis				20		$^\circ C$
<b>DIGITAL INPUT (SHDN)</b>						
Input-Voltage High	$V_{IH}$		1.4			V
Input-Voltage Low	$V_{IL}$				0.4	V
Input Leakage Current		$T_A = +25^\circ C$ , $\overline{SHDN} = 0$			$\pm 1$	$\mu A$

**Note 2:** This device is 100% production tested at  $T_A = +25^\circ C$ . All temperature limits are guaranteed by design.

**Note 3:** Amplifier inputs AC-coupled to ground.

**Note 4:** Specified at room temperature with an  $8\Omega$  resistive load in series with a  $68\mu H$  inductive load.

**Typical Operating Characteristics**

( $V_{PVDD} = V_{SHDN} = 5.0V$ ,  $V_{PGND} = 0V$ ,  $A_V = 12dB$ ,  $R_L = \infty$ ,  $R_L$  connected between  $OUT_+$  to  $OUT_-$ , 20Hz to 22kHz AC measurement bandwidth,  $T_A = +25^\circ C$ , unless otherwise noted.)

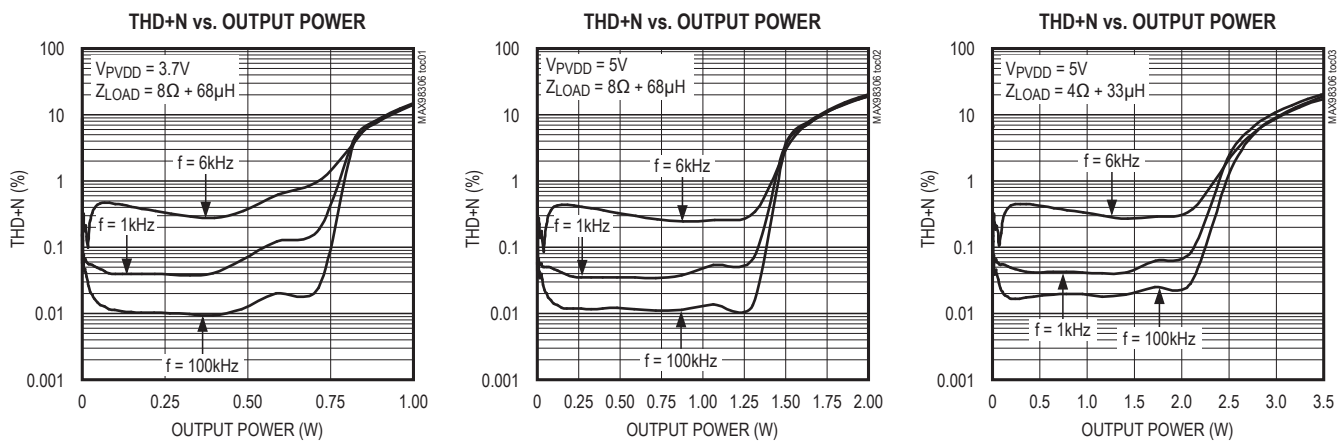

Typical Operating Characteristics (continued)

( $V_{PVDD} = V_{SHDN} = 5.0V$ ,  $V_{PGND} = 0V$ ,  $AV = 12dB$ ,  $R_L = \infty$ ,  $R_L$  connected between  $OUT_+$  to  $OUT_-$ , 20Hz to 22kHz AC measurement bandwidth,  $T_A = +25^\circ C$ , unless otherwise noted.)

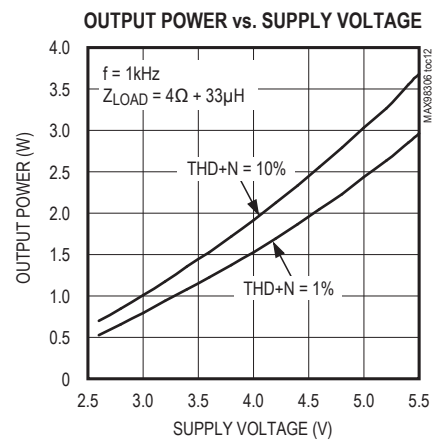
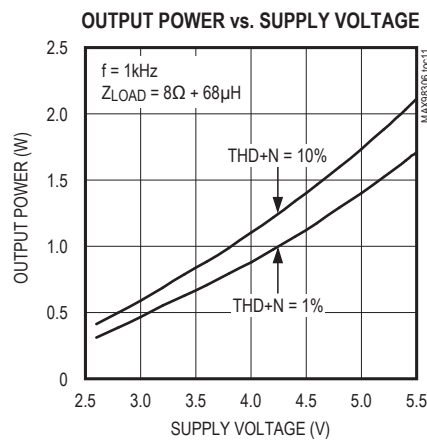
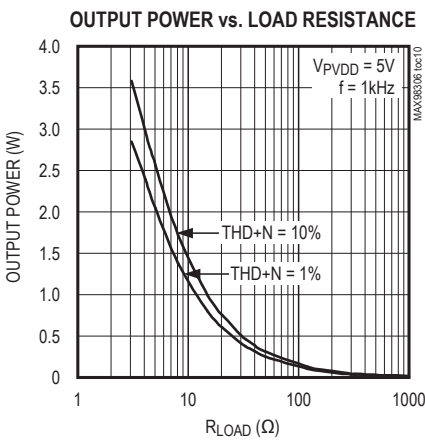
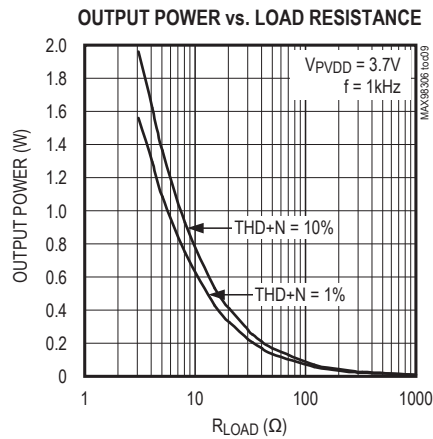
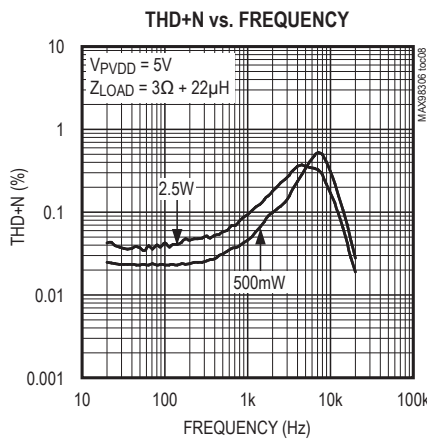
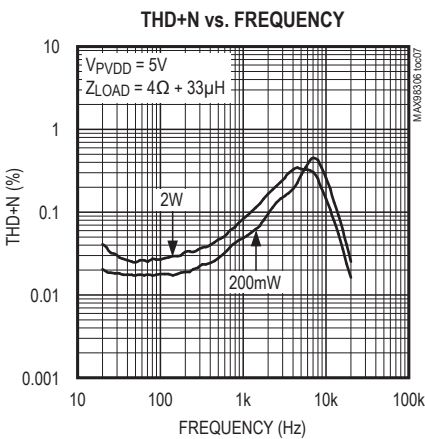
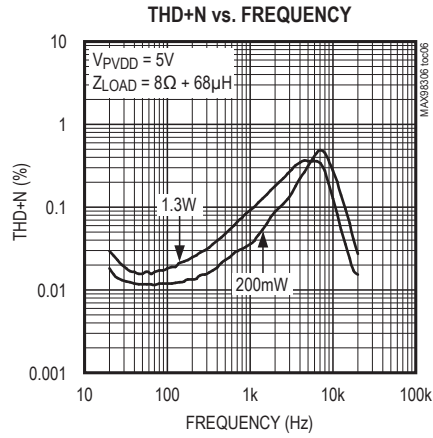
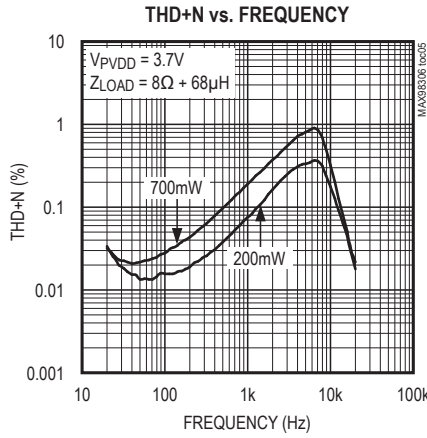
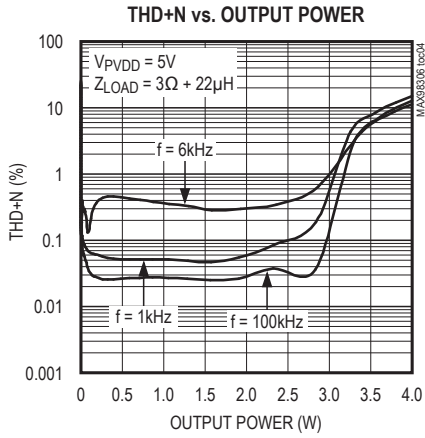

Typical Operating Characteristics (continued)

( $V_{PVDD} = V_{SHDN} = 5.0V$ ,  $V_{PGND} = 0V$ ,  $AV = 12dB$ ,  $R_L = \infty$ ,  $R_L$  connected between  $OUT_+$  to  $OUT_-$ , 20Hz to 22kHz AC measurement bandwidth,  $T_A = +25^\circ C$ , unless otherwise noted.)

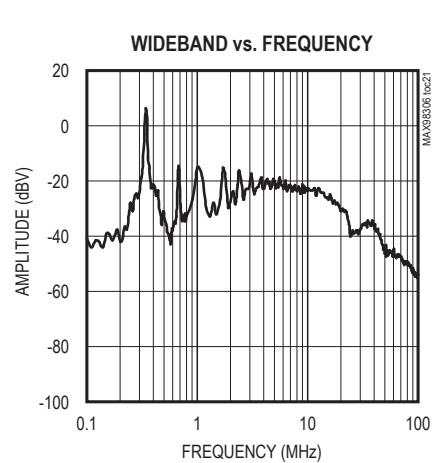
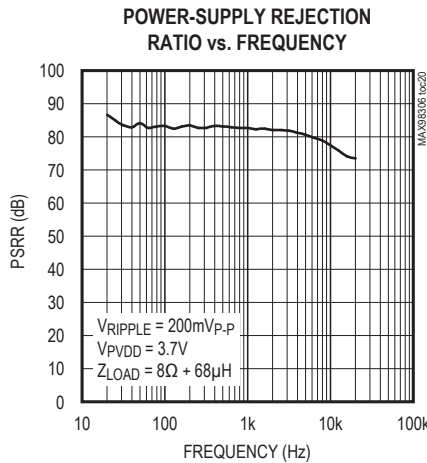
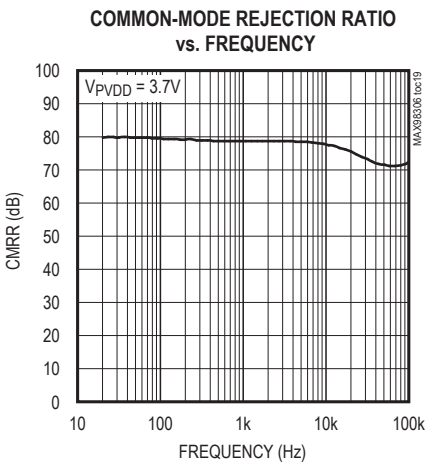
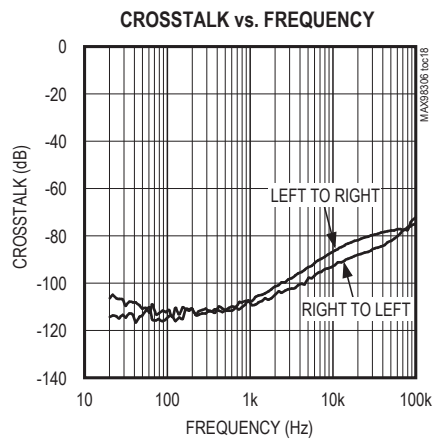
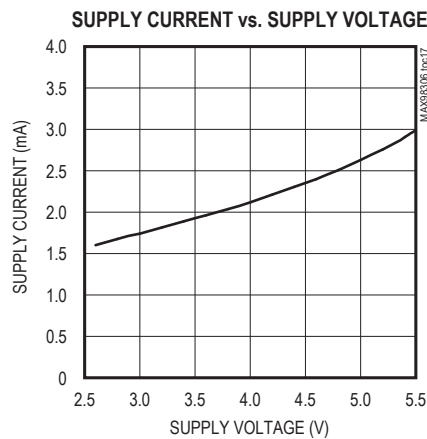
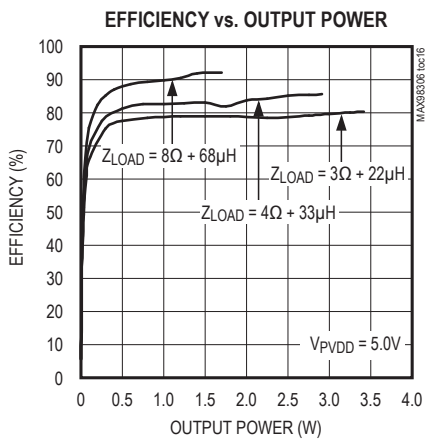
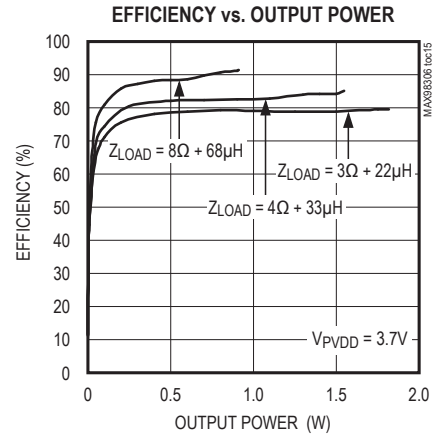
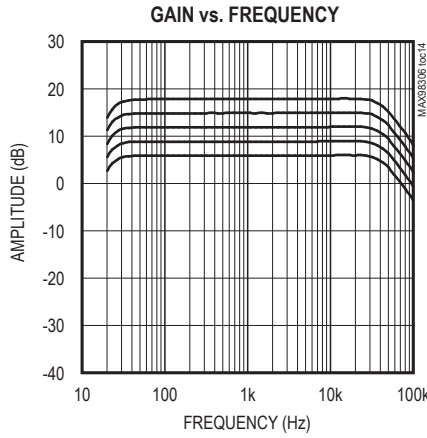
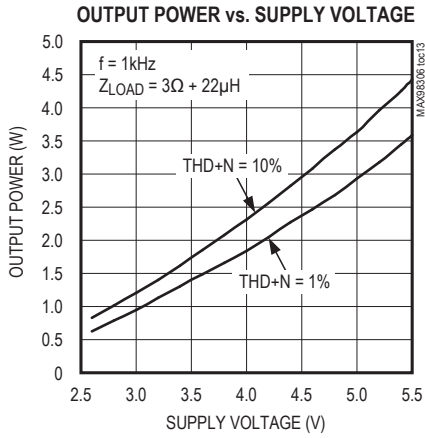

### Typical Operating Characteristics (continued)

( $V_{PVDD} = V_{SHDN} = 5.0V$ ,  $V_{PGND} = 0V$ ,  $AV = 12dB$ ,  $R_L = \infty$ ,  $R_L$  connected between  $OUT_+$  to  $OUT_-$ , 20Hz to 22kHz AC measurement bandwidth,  $T_A = +25^\circ C$ , unless otherwise noted.)

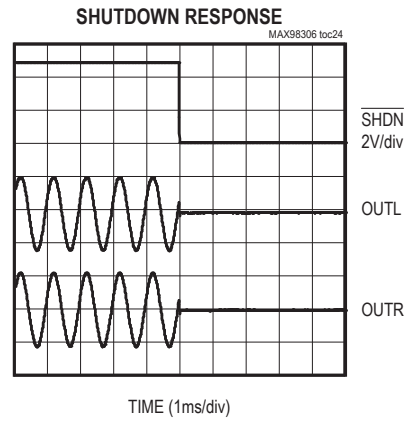
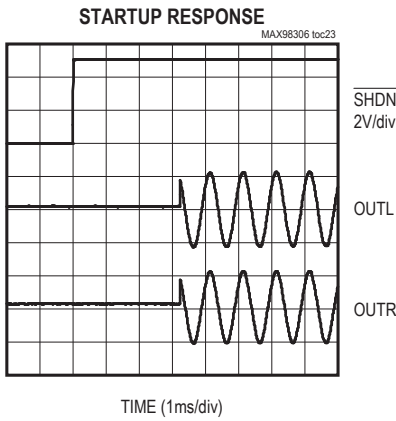
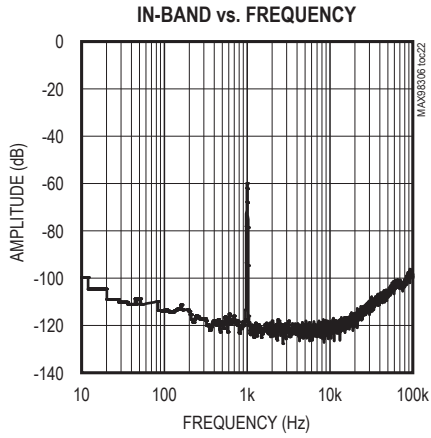



### Detailed Description

The MAX98306 features low quiescent current, a low-power shutdown mode, comprehensive click-and-pop suppression, and excellent RF immunity.

The IC offers Class AB audio performance with Class D efficiency in a minimal board-space solution.

The Class D amplifier features spread-spectrum modulation, active emissions limiting, edge-rate, and overshoot control circuitry that offers significant improvements to switch-mode amplifier radiated emissions.

The amplifier also features click-and-pop suppression that reduces audible transients on startup and shutdown, as well as thermal-overload and short-circuit protection.

### Class D Speaker Amplifier

The filterless Class D amplifier output stage offers much higher efficiency than Class AB amplifiers. The high efficiency of a Class D amplifier is due to the pulse-width modulated (PWM) rail-to-rail switching operation of the output stage transistors. This ensures that any power loss associated with the Class D output stage is mostly due to the  $I^2R$  loss of the MOSFET on-resistance and quiescent current overhead.

### EMI Filterless Output Stage

Traditional Class D amplifiers require the use of external LC filters, or shielding, to meet EN55022B electromagnetic-interference (EMI) regulation standards. Maxim's active-emissions-limiting edge-rate control circuitry and spread-spectrum modulation reduce EMI emissions, while maintaining up to 92% efficiency.

Spread-spectrum modulation and active emissions limiting limit wideband spectral components, while proprietary techniques ensure that the cycle-to-cycle variation of the switching period does not degrade audio reproduction or efficiency. The IC's spread-spectrum modulator randomly varies the switching frequency by  $\pm 20\text{kHz}$  around the center frequency (320kHz). Above 10MHz, the wideband spectrum looks like noise for EMI purposes (Figure 1).

### Speaker Current Limit

If the output current of the speaker amplifier exceeds the current limit (3A typ), the IC disables the outputs for approximately 100 $\mu\text{s}$ . At the end of 100 $\mu\text{s}$ , the outputs are reenabled. If the fault condition still exists, the IC continues to disable and reenables the outputs until the fault condition is removed.

Table 1. Gain Control Configuration

GAIN PIN	MAXIMUM GAIN (dB)
Connect to PGND	18
Connect to PGND through 100k $\Omega$ $\pm 5\%$ resistor	15
Connect to PVDD	12
Connect to PVDD through 100k $\Omega$ $\pm 5\%$ resistor	9
Unconnected	6

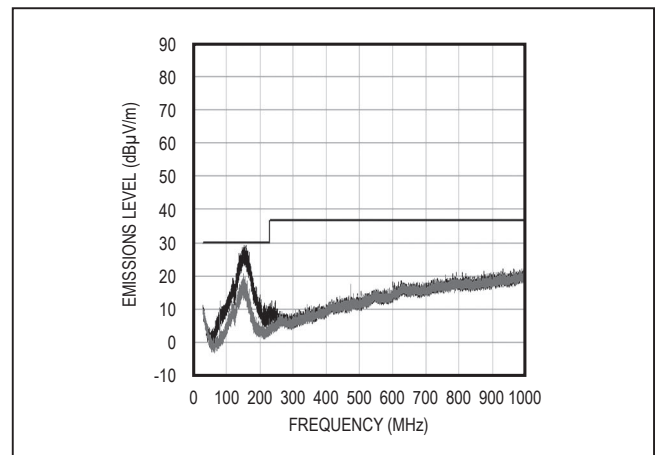

Figure 1. EMI with 12in of Speaker Cable and No Output Filter

### Selectable Gain

The IC offers five programmable gains selected using the GAIN input.

### Shutdown

The IC features a low-power shutdown mode, drawing  $\leq 1\mu\text{A}$  (typ) of supply current. Drive  $\overline{\text{SHDN}}$  low to place the MAX98306 into shutdown. Drive  $\overline{\text{SHDN}}$  above 1.4V for normal operation.

### Click-and-Pop Suppression

The IC speaker amplifier features Maxim's comprehensive click-and-pop suppression. During startup, the click-and-pop suppression circuitry reduces any audible transient sources internal to the device. When entering shutdown, the differential speaker outputs ramp down to PGND quickly and simultaneously.

## Applications Information

### Filterless Class D Operation

Traditional Class D amplifiers require an output filter. The filter adds cost and size and decreases THD performance. The IC's filterless modulation scheme does not require an output filter.

Because the switching frequency of the IC is well beyond the bandwidth of most speakers, voice coil movement due to the switching frequency is very small. Use a speaker with a series inductance > 10μH. Typical 8Ω speakers exhibit series inductances in the 20μH to 100μH range.

### Component Selection

#### Power-Supply Input (PVDD)

PVDD powers the speaker amplifier. PVDD ranges from 2.6V to 5.5V. Bypass PVDD with 0.1μF and 10μF capacitors to PGND. Apply additional bulk capacitance at the device if long input traces between PVDD and the power source are used.

#### Input Filtering

The input-coupling capacitor ( $C_{IN}$ ), in conjunction with the amplifier's internal input resistance ( $R_{IN}$ ), forms a highpass filter that removes the DC bias from the incoming signal. These capacitors allow the amplifier to bias the signal to an optimum DC level.

Assuming zero source impedance,  $C_{IN}$  is:

$$C_{IN} = \frac{1}{2\pi f_{-3dB} \times R_{IN}}$$

where  $f_{-3dB}$  is the -3dB corner frequency and  $R_{IN}$  is the typical value as specified in the *Electrical Characteristics* table. Use capacitors with adequately low-voltage coefficients for best low-frequency THD performance. Table 2 shows calculated capacitance values based on a 20Hz highpass filter.

**Table 2. Capacitance Value for 20Hz Highpass Filter**

GAIN	$R_{IN}$ (kΩ)	$C_{IN}$ for 20Hz (nF)
18	33	241
15	46	173
12	65	122
9	93	86
6	131	61

### Layout and Grounding

Proper layout and grounding are essential for optimum performance. Good grounding improves audio performance and prevents switching noise from coupling into the audio signal.

Use wide, low-resistance output traces. As the load impedance decreases, the current drawn from the device increases. At higher current, the resistance of the output traces decrease the power delivered to the load. For example, if 2W is delivered from the device output to a 4Ω load through 100mΩ of total speaker trace, 1.904W is delivered to the speaker. If power is delivered through 10mΩ of total speaker trace, 1.99W is delivered to the speaker. Wide output, supply, and ground traces also improve the power dissipation of the device.

The IC is inherently designed for excellent RF immunity. For best performance, add ground fills around all signal traces on top or bottom PCB planes.

## Chip Information

PROCESS: CMOS

Block Diagram

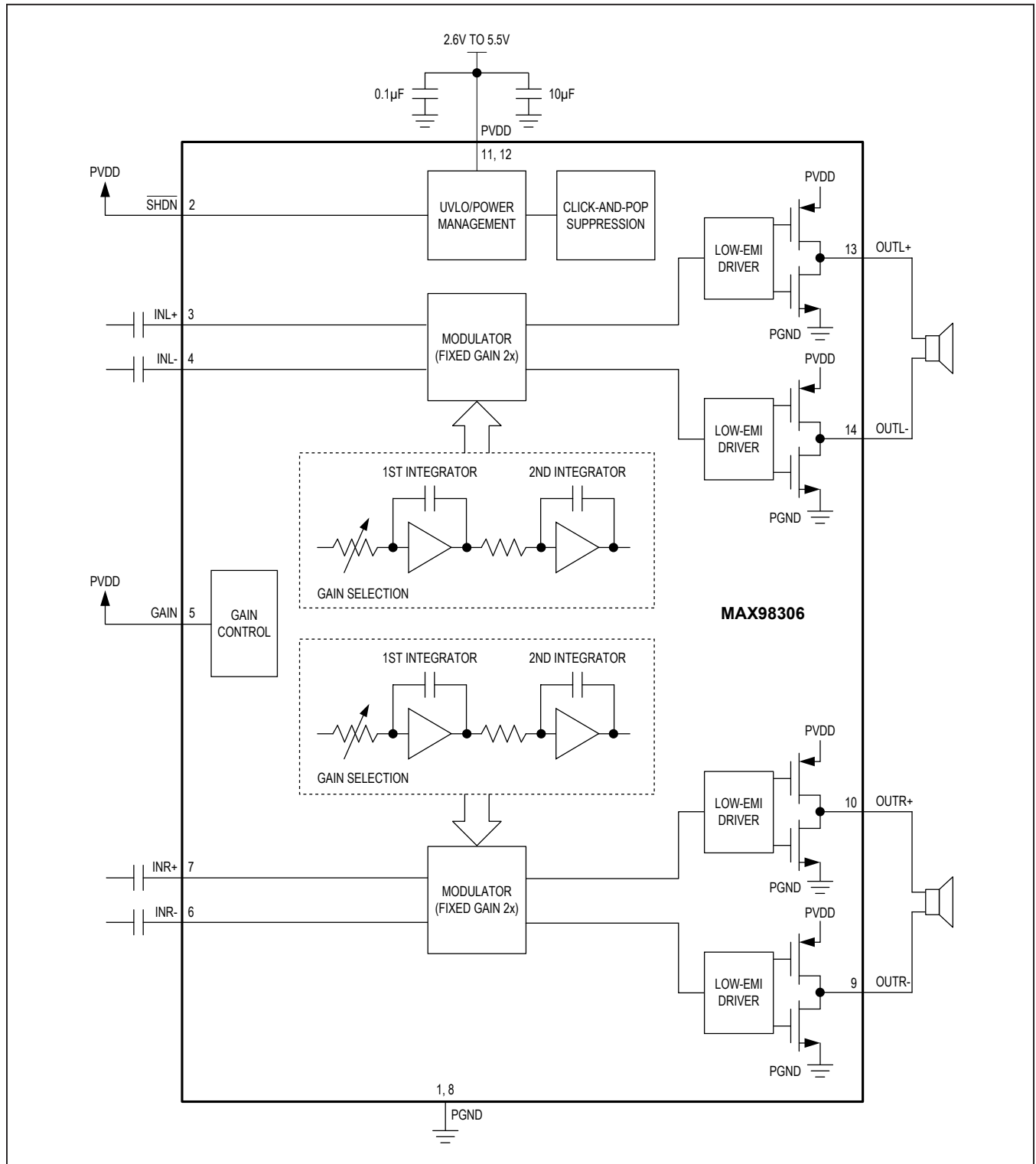

## Package Information

For the latest package outline information and land patterns (footprints), go to [www.maximintegrated.com/packages](http://www.maximintegrated.com/packages). Note that a "+", "#", or "-" in the package code indicates RoHS status only. Package drawings may show a different suffix character, but the drawing pertains to the package regardless of RoHS status.

PACKAGE TYPE	PACKAGE CODE	OUTLINE NO.	LAND PATTERN NO.
14 TDFN	T1433+2	<a href="#">21-0137</a>	<a href="#">90-0063</a>

## Revision History

REVISION NUMBER	REVISION DATE	DESCRIPTION	PAGES CHANGED
0	6/11	Initial release	—
1	8/11	Updated output power in <i>Electrical Characteristics</i>	3
2	12/17	Removed package outline drawings	12, 13

For pricing, delivery, and ordering information, please contact Maxim Direct at 1-888-629-4642, or visit Maxim Integrated's website at [www.maximintegrated.com](http://www.maximintegrated.com).

*Maxim Integrated cannot assume responsibility for use of any circuitry other than circuitry entirely embodied in a Maxim Integrated product. No circuit patent licenses are implied. Maxim Integrated reserves the right to change the circuitry and specifications without notice at any time. The parametric values (min and max limits) shown in the Electrical Characteristics table are guaranteed. Other parametric values quoted in this data sheet are provided for guidance.*

## Looking for pricing, stock, or lifecycle information?

Click below to explore more details on WIN SOURCE:

- ⊖ [View MAX98306ETD+T on WIN SOURCE](#)
- ⊖ [Maxim Integrated Information](#)

## Optimize Your Supply Chain with WIN SOURCE Solutions

- ✓ Global Sourcing Solution
- ✓ Obsolete Management
- ✓ Cost Control Management
- ✓ Shortage Management
- ✓ Alternative Solution
- ✓ Excess Inventory Management