



**THE DATASHEET OF
PTVS54VP1UP,115**





PTVSxP1UP series

600 W Transient Voltage Suppressor

Rev. 2 — 6 January 2011

Product data sheet

1. Product profile

1.1 General description

600 W unidirectional Transient Voltage Suppressor (TVS) in a SOD128 small and flat lead Surface-Mounted Device (SMD) plastic package, designed for transient overvoltage protection.

1.2 Features and benefits

- Rated peak pulse power: $P_{PPM} = 600 \text{ W}$
- Reverse standoff voltage range: $V_{RWM} = 3.3 \text{ V to } 64 \text{ V}$
- Reverse current: $I_{RM} = 0.001 \mu\text{A}$
- Very low package height: 1 mm
- Small plastic package suitable for surface-mounted design
- AEC-Q101 qualified

1.3 Applications

- Power supply protection
- Automotive application
- Industrial application
- Power management

1.4 Quick reference data



Table 1. Quick reference data

Symbol	Parameter	Conditions	Min	Typ	Max	Unit
P_{PPM}	rated peak pulse power		[1] -	-	600	W
V_{RWM}	reverse standoff voltage		3.3	-	64	V

[1] In accordance with IEC 61643-321 (10/1000 μs current waveform).

2. Pinning information

Table 2. Pinning

Pin	Description	Simplified outline	Graphic symbol
1	cathode	[1]	 sym035
2	anode		

[1] The marking bar indicates the cathode.

3. Ordering information

Table 3. Ordering information

Type number [1]	Package		
	Name	Description	Version
PTVSxP1UP series	-	plastic surface-mounted package; 2 leads	SOD128

[1] The series consists of 35 types with reverse standoff voltages from 3.3 V to 64 V.

4. Marking

Table 4. Marking codes

Type number	Marking code	Type number	Marking code
PTVS3V3P1UP	AJ	PTVS20VP1UP	B3
PTVS5V0P1UP	AK	PTVS22VP1UP	B4
PTVS6V0P1UP	AL	PTVS24VP1UP	B5
PTVS6V5P1UP	AM	PTVS26VP1UP	B6
PTVS7V0P1UP	AN	PTVS28VP1UP	B7
PTVS7V5P1UP	AP	PTVS30VP1UP	B8
PTVS8V0P1UP	AQ	PTVS33VP1UP	B9
PTVS8V5P1UP	AR	PTVS36VP1UP	BA
PTVS9V0P1UP	AS	PTVS40VP1UP	BB
PTVS10VP1UP	AT	PTVS43VP1UP	BC
PTVS11VP1UP	AU	PTVS45VP1UP	BD
PTVS12VP1UP	AV	PTVS48VP1UP	BE
PTVS13VP1UP	AW	PTVS51VP1UP	BF
PTVS14VP1UP	AX	PTVS54VP1UP	BG
PTVS15VP1UP	AY	PTVS58VP1UP	BH
PTVS16VP1UP	AZ	PTVS60VP1UP	BJ
PTVS17VP1UP	B1	PTVS64VP1UP	BK
PTVS18VP1UP	B2	-	-

5. Limiting values

Table 5. Limiting values

In accordance with the Absolute Maximum Rating System (IEC 60134).

Symbol	Parameter	Conditions	Min	Max	Unit
P_{PPM}	rated peak pulse power		[1] -	600	W
I_{PPM}	rated peak pulse current		[1] -	see Table 9 and 10	
I_{FSM}	Non-repetitive peak forward current	single half-sine wave; $t_p = 8.3$ ms	-	100	A
T_j	junction temperature		-	150	°C
T_{amb}	ambient temperature		-55	+150	°C
T_{stg}	storage temperature		-65	+150	°C

[1] In accordance with IEC 61643-321 (10/1000 μ s current waveform).

Table 6. ESD maximum ratings

$T_{amb} = 25$ °C unless otherwise specified.

Symbol	Parameter	Conditions	Min	Max	Unit
Per diode					
V_{ESD}	electrostatic discharge voltage	IEC 61000-4-2 (contact discharge)	[1][2] -	30	kV

[1] Device stressed with ten non-repetitive ElectroStatic Discharge (ESD) pulses.

[2] Soldering point of cathode tab.

Table 7. ESD standards compliance

Standard	Conditions
Per diode	
IEC 61000-4-2; level 4 (ESD)	> 15 kV (air); > 8 kV (contact)
MIL-STD-883; class 3 (human body model)	> 4 kV

6. Thermal characteristics

Table 8. Thermal characteristics

Symbol	Parameter	Conditions	Min	Typ	Max	Unit
$R_{th(j-a)}$	thermal resistance from junction to ambient	in free air	[1] -	-	200	K/W
			[2] -	-	120	K/W
			[3] -	-	60	K/W
$R_{th(j-sp)}$	thermal resistance from junction to solder point		[4] -	-	12	K/W

[1] Device mounted on an FR4 Printed-Circuit Board (PCB), single-sided copper, tin-plated and standard footprint.

[2] Device mounted on an FR4 PCB, single-sided copper, tin-plated, mounting pad for cathode 1 cm².

[3] Device mounted on a ceramic PCB, Al₂O₃, standard footprint.

[4] Soldering point of cathode tab.

7. Characteristics

Table 9. Characteristics per type; PTVS3V3P1UP to PTVS7V0P1UP

$T_j = 25\text{ °C}$ unless otherwise specified.

Type number	Reverse standoff voltage V_{RWM} (V)	Breakdown voltage V_{BR} (V)			Reverse leakage current I_{RM} (μ A)		Clamping voltage V_{CL} (V)	
		$I_R = 10\text{ mA}$			at V_{RWM} (V)		Max	I_{PPM} (A)
	Max	Min	Typ	Max	Typ	Max		
PTVS3V3P1UP	3.3	5.20	5.60	6.00	5	600	8.0	75.0
PTVS5V0P1UP	5.0	6.40	6.70	7.00	5	400	9.2	65.2
PTVS6V0P1UP	6.0	6.67	7.02	7.37	5	400	10.3	58.3
PTVS6V5P1UP	6.5	7.22	7.60	7.98	5	250	11.2	53.6
PTVS7V0P1UP	7.0	7.78	8.20	8.60	3	100	12.0	50.0

Table 10. Characteristics per type; PTVS7V5P1UP to PTVS64VP1UP

$T_j = 25\text{ °C}$ unless otherwise specified.

Type number	Reverse standoff voltage V_{RWM} (V)	Breakdown voltage V_{BR} (V)			Reverse leakage current I_{RM} (μ A)		Clamping voltage V_{CL} (V)	
		$I_R = 1\text{ mA}$			at V_{RWM} (V)		Max	I_{PPM} (A)
	Max	Min	Typ	Max	Typ	Max		
PTVS7V5P1UP	7.5	8.33	8.77	9.21	0.2	50	12.9	46.5
PTVS8V0P1UP	8.0	8.89	9.36	9.83	0.03	25	13.6	44.1
PTVS8V5P1UP	8.5	9.44	9.92	10.40	0.01	10	14.4	41.7
PTVS9V0P1UP	9.0	10.00	10.55	11.10	0.005	5	15.4	39.0
PTVS10VP1UP	10	11.10	11.70	12.30	0.005	2.5	17.0	35.3
PTVS11VP1UP	11	12.20	12.85	13.50	0.005	2.5	18.2	33.0
PTVS12VP1UP	12	13.30	14.00	14.70	0.005	2.5	19.9	30.2
PTVS13VP1UP	13	14.40	15.15	15.90	0.001	0.1	21.5	27.9
PTVS14VP1UP	14	15.60	16.40	17.20	0.001	0.1	23.2	25.9
PTVS15VP1UP	15	16.70	17.60	18.50	0.001	0.1	24.4	24.6
PTVS16VP1UP	16	17.80	18.75	19.70	0.001	0.1	26.0	23.1
PTVS17VP1UP	17	18.90	19.90	20.90	0.001	0.1	27.6	21.7
PTVS18VP1UP	18	20.00	21.00	22.10	0.001	0.1	29.2	20.5
PTVS20VP1UP	20	22.20	23.35	24.50	0.001	0.1	32.4	18.5
PTVS22VP1UP	22	24.40	25.60	26.90	0.001	0.1	35.5	16.9
PTVS24VP1UP	24	26.70	28.10	29.50	0.001	0.1	38.9	15.4
PTVS26VP1UP	26	28.90	30.40	31.90	0.001	0.1	42.1	14.3
PTVS28VP1UP	28	31.10	32.80	34.40	0.001	0.1	45.4	13.2
PTVS30VP1UP	30	33.30	35.10	36.80	0.001	0.1	48.4	12.4
PTVS33VP1UP	33	36.70	38.70	40.60	0.001	0.1	53.3	11.3
PTVS36VP1UP	36	40.00	42.10	44.20	0.001	0.1	58.1	10.3
PTVS40VP1UP	40	44.40	46.80	49.10	0.001	0.1	64.5	9.3

Table 10. Characteristics per type; PTVS7V5P1UP to PTVS64VP1UP ...continued $T_j = 25\text{ °C}$ unless otherwise specified.

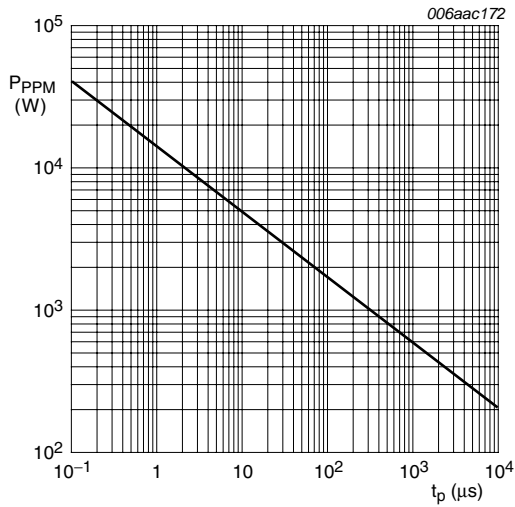
Type number	Reverse standoff voltage V_{RWM} (V)	Breakdown voltage V_{BR} (V)			Reverse leakage current I_{RM} (μ A)		Clamping voltage V_{CL} (V)	
		$I_R = 1\text{ mA}$			at V_{RWM} (V)		Max	I_{PPM} (A)
	Max	Min	Typ	Max	Typ	Max		
PTVS43VP1UP	43	47.80	50.30	52.80	0.001	0.1	69.4	8.6
PTVS45VP1UP	45	50.00	52.65	55.30	0.001	0.1	72.7	8.3
PTVS48VP1UP	48	53.30	56.10	58.90	0.001	0.1	77.4	7.8
PTVS51VP1UP	51	56.70	59.70	62.70	0.001	0.1	82.4	7.3
PTVS54VP1UP	54	60.00	63.15	66.30	0.001	0.1	87.1	6.9
PTVS58VP1UP	58	64.40	67.80	71.20	0.001	0.1	93.6	6.4
PTVS60VP1UP	60	66.70	70.20	73.70	0.001	0.1	96.8	6.2
PTVS64VP1UP	64	71.10	74.85	78.60	0.001	0.1	103.0	5.8



Fig 1. 10/1000 μ s pulse waveform according to IEC 61643-321

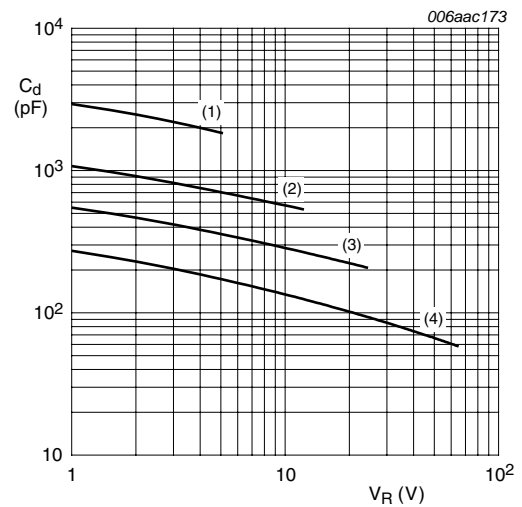


Fig 2. Relative variation of rated peak pulse power as a function of junction temperature; typical values



$T_{amb} = 25^\circ C$

Fig 3. Rated peak pulse power as a function of pulse duration; typical values



$T_{amb} = 25^\circ C; f = 1$ MHz

- (1) PTVS5V0P1UP
- (2) PTVS12VP1UP
- (3) PTVS24VP1UP
- (4) PTVS64VP1UP

Fig 4. Diode capacitance as a function of reverse voltage; typical values

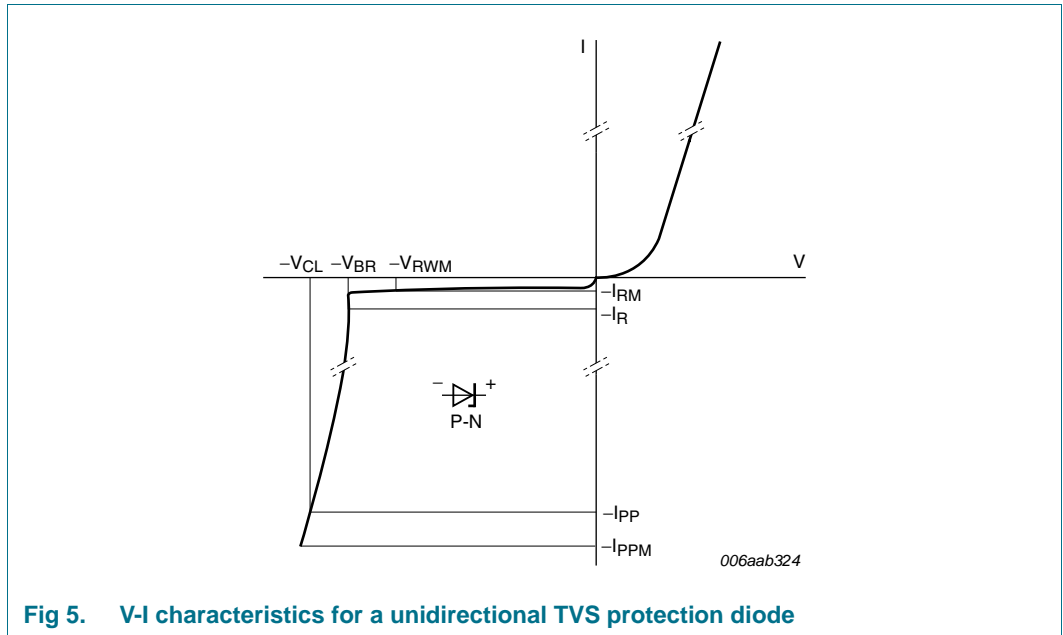


Fig 5. V-I characteristics for a unidirectional TVS protection diode

8. Test information

8.1 Quality information

This product has been qualified in accordance with the Automotive Electronics Council (AEC) standard Q101 - *Stress test qualification for discrete semiconductors*, and is suitable for use in automotive applications.

9. Package outline

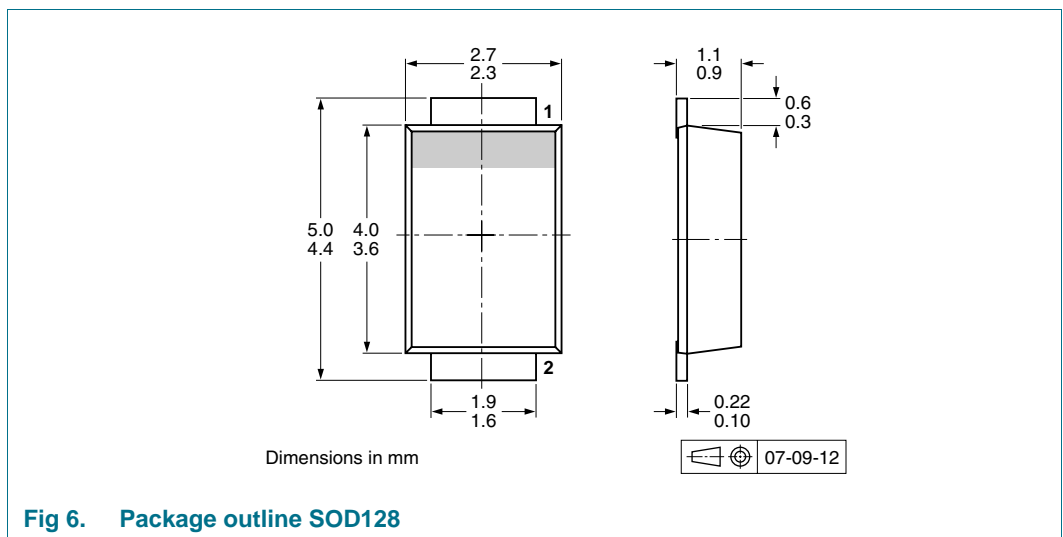


Fig 6. Package outline SOD128

10. Packing information

Table 11. Packing methods

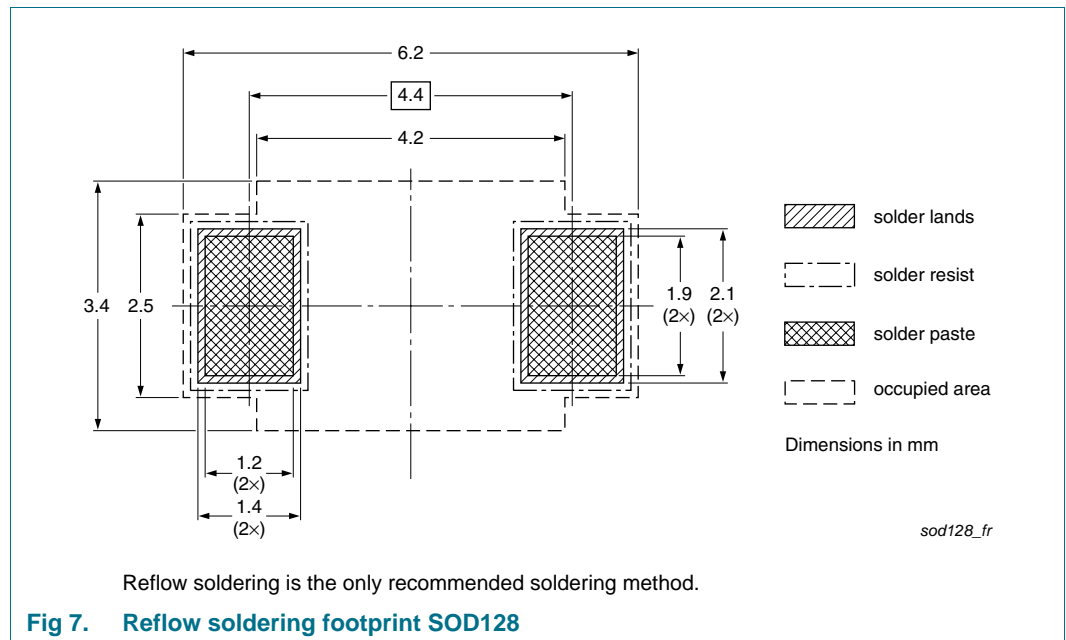
The indicated -xxx are the last three digits of the 12NC ordering code.^[1]

Type number ^[2]	Package	Description	Packing quantity
PTVSxP1UP series	SOD128	4 mm pitch, 12 mm tape and reel	3000
			-115

[1] For further information and the availability of packing methods, see [Section 14](#).

[2] The series consists of 35 types with reverse standoff voltages from 3.3 V to 64 V.

11. Soldering



12. Revision history

Table 12. Revision history

Document ID	Release date	Data sheet status	Change notice	Supersedes
PTVSXP1UP_SER v.2	20110106	Product data sheet	-	PTVSXP1UP_SER v.1
Modifications:	<ul style="list-style-type: none">• Table 6 “ESD maximum ratings”: added.• Section 13 “Legal information”: updated.			
PTVSXP1UP_SER v.1	20100527	Product data sheet	-	-

13. Legal information

13.1 Data sheet status

Document status ^{[1][2]}	Product status ^[3]	Definition
Objective [short] data sheet	Development	This document contains data from the objective specification for product development.
Preliminary [short] data sheet	Qualification	This document contains data from the preliminary specification.
Product [short] data sheet	Production	This document contains the product specification.

[1] Please consult the most recently issued document before initiating or completing a design.

[2] The term 'short data sheet' is explained in section "Definitions".

[3] The product status of device(s) described in this document may have changed since this document was published and may differ in case of multiple devices. The latest product status information is available on the Internet at URL <http://www.nexperia.com>.

13.2 Definitions

Draft — The document is a draft version only. The content is still under internal review and subject to formal approval, which may result in modifications or additions. Nexperia does not give any representations or warranties as to the accuracy or completeness of information included herein and shall have no liability for the consequences of use of such information.

Short data sheet — A short data sheet is an extract from a full data sheet with the same product type number(s) and title. A short data sheet is intended for quick reference only and should not be relied upon to contain detailed and full information. For detailed and full information see the relevant full data sheet, which is available on request via the local Nexperia sales office. In case of any inconsistency or conflict with the short data sheet, the full data sheet shall prevail.

Product specification — The information and data provided in a Product data sheet shall define the specification of the product as agreed between Nexperia and its customer, unless Nexperia and customer have explicitly agreed otherwise in writing. In no event however, shall an agreement be valid in which the Nexperia product is deemed to offer functions and qualities beyond those described in the Product data sheet.

13.3 Disclaimers

Limited warranty and liability — Information in this document is believed to be accurate and reliable. However, Nexperia does not give any representations or warranties, expressed or implied, as to the accuracy or completeness of such information and shall have no liability for the consequences of use of such information.

In no event shall Nexperia be liable for any indirect, incidental, punitive, special or consequential damages (including - without limitation - lost profits, lost savings, business interruption, costs related to the removal or replacement of any products or rework charges) whether or not such damages are based on tort (including negligence), warranty, breach of contract or any other legal theory.

Notwithstanding any damages that customer might incur for any reason whatsoever, Nexperia's aggregate and cumulative liability towards customer for the products described herein shall be limited in accordance with the *Terms and conditions of commercial sale* of Nexperia.

Right to make changes — Nexperia reserves the right to make changes to information published in this document, including without limitation specifications and product descriptions, at any time and without notice. This document supersedes and replaces all information supplied prior to the publication hereof.

Suitability for use — Nexperia products are not designed, authorized or warranted to be suitable for use in life support, life-critical or safety-critical systems or equipment, nor in applications where failure or

malfunction of a Nexperia product can reasonably be expected to result in personal injury, death or severe property or environmental damage. Nexperia accepts no liability for inclusion and/or use of Nexperia products in such equipment or applications and therefore such inclusion and/or use is at the customer's own risk.

Applications — Applications that are described herein for any of these products are for illustrative purposes only. Nexperia makes no representation or warranty that such applications will be suitable for the specified use without further testing or modification.

Customers are responsible for the design and operation of their applications and products using Nexperia products, and Nexperia accepts no liability for any assistance with applications or customer product design. It is customer's sole responsibility to determine whether the Nexperia product is suitable and fit for the customer's applications and products planned, as well as for the planned application and use of customer's third party customer(s). Customers should provide appropriate design and operating safeguards to minimize the risks associated with their applications and products.

Nexperia does not accept any liability related to any default, damage, costs or problem which is based on any weakness or default in the customer's applications or products, or the application or use by customer's third party customer(s). Customer is responsible for doing all necessary testing for the customer's applications and products using Nexperia products in order to avoid a default of the applications and the products or of the application or use by customer's third party customer(s). Nexperia does not accept any liability in this respect.

Limiting values — Stress above one or more limiting values (as defined in the Absolute Maximum Ratings System of IEC 60134) will cause permanent damage to the device. Limiting values are stress ratings only and (proper) operation of the device at these or any other conditions above those given in the Recommended operating conditions section (if present) or the Characteristics sections of this document is not warranted. Constant or repeated exposure to limiting values will permanently and irreversibly affect the quality and reliability of the device.

Terms and conditions of commercial sale — Nexperia products are sold subject to the general terms and conditions of commercial sale, as published at <http://www.nexperia.com/profile/terms>, unless otherwise agreed in a valid written individual agreement. In case an individual agreement is concluded only the terms and conditions of the respective agreement shall apply. Nexperia hereby expressly objects to applying the customer's general terms and conditions with regard to the purchase of Nexperia products by customer.

No offer to sell or license — Nothing in this document may be interpreted or construed as an offer to sell products that is open for acceptance or the grant, conveyance or implication of any license under any copyrights, patents or other industrial or intellectual property rights.

Export control — This document as well as the item(s) described herein may be subject to export control regulations. Export might require a prior authorization from national authorities.

Quick reference data — The Quick reference data is an extract of the product data given in the Limiting values and Characteristics sections of this document, and as such is not complete, exhaustive or legally binding.

13.4 Trademarks

Notice: All referenced brands, product names, service names and trademarks are the property of their respective owners.

14. Contact information

For more information, please visit: <http://www.nexperia.com>



For sales office addresses, please send an email to: salesaddresses@nexperia.com

15. Contents

1	Product profile	1
1.1	General description	1
1.2	Features and benefits	1
1.3	Applications	1
1.4	Quick reference data	1
2	Pinning information	2
3	Ordering information	2
4	Marking	2
5	Limiting values	3
6	Thermal characteristics	3
7	Characteristics	4
8	Test information	7
8.1	Quality information	7
9	Package outline	7
10	Packing information	8
11	Soldering	8
12	Revision history	9
13	Legal information	10
13.1	Data sheet status	10
13.2	Definitions	10
13.3	Disclaimers	10
13.4	Trademarks	11
14	Contact information	11
15	Contents	12

Looking for pricing, stock, or lifecycle information?

Click below to explore more details on WIN SOURCE:

-  [View PTVS54VP1UP,115 on WIN SOURCE](#)
-  [Nexperia USA Inc. Information](#)

Optimize Your Supply Chain with WIN SOURCE Solutions

-  Global Sourcing Solution
-  Obsolete Management
-  Cost Control Management
-  Shortage Management
-  Alternative Solution
-  Excess Inventory Management