



**THE DATASHEET OF
AP133-SNG-7**



**300mA, LOW QUIESCENT CURRENT, FAST TRANSIENT
LOW DROPOUT LINEAR REGULATOR**

Description

The AP133 is a 300mA, adjustable output voltage, low dropout linear regulator. The device includes pass element, error amplifier, band-gap, current limit and thermal shutdown circuitry. The device is turned on when EN pin is set to logic high level.

The characteristics of low dropout voltage and less quiescent current make it good for low power applications, for example, battery powered devices. The typical quiescent current is approximately 40µA from zero to maximum load.

Built-in current-limit and thermal-shutdown functions prevent IC from damage in fault conditions.

The AP133 is available in SOT25 and DFN2020-6 packages.

Features

- 300mA Low Dropout Regulator with EN
- Very Low I_Q: 40µA
- Wide Input Voltage Range: 2V to 6V
- Adjustable Output: 1V to 5V
- High PSRR: 65dB at 1kHz
- Ultra-fast Start-Up Time: 25µs
- Stable with Low ESR, 1µF Ceramic Output Capacitor
- Excellent Load/Line Transient Response
- Low Dropout: 350mV at 300mA
- Current Limit Protection
- Short Circuit Protection
- Thermal Shutdown Protection
- Ambient Temperature Range: -40°C to +85°C
- SOT25 and DFN2020-6: Available in "Green" Molding Compound (No Br, Sb)
- **Lead-Free Finish; RoHS Compliant (Notes 1 & 2)**
- **Halogen and Antimony Free. "Green" Device (Note 3)**

Notes:

1. EU Directive 2002/95/EC (RoHS), 2011/65/EU (RoHS 2) & 2015/863/EU (RoHS 3) compliant. All applicable RoHS exemptions applied.
2. See http://www.diodes.com/quality/lead_free/ for more information about Diodes Incorporated's definitions of Halogen- and Antimony-free, "Green" and Lead-free.
3. Halogen- and Antimony-free "Green" products are defined as those which contain <900ppm bromine, <900ppm chlorine (<1500ppm total Br + Cl) and <1000ppm antimony compounds.

Pin Assignments

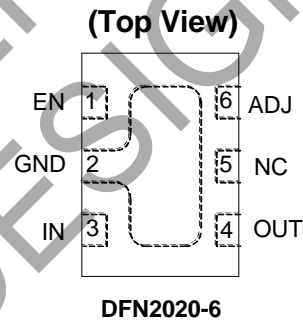
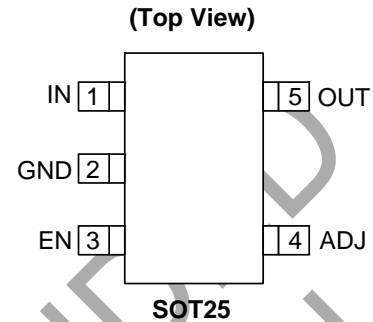

Applications

- Cellular Phones
- Smart Phones, PDAs
- MP3/MP4
- Bluetooth Head Set
- Low Power Application

Typical Applications Circuit

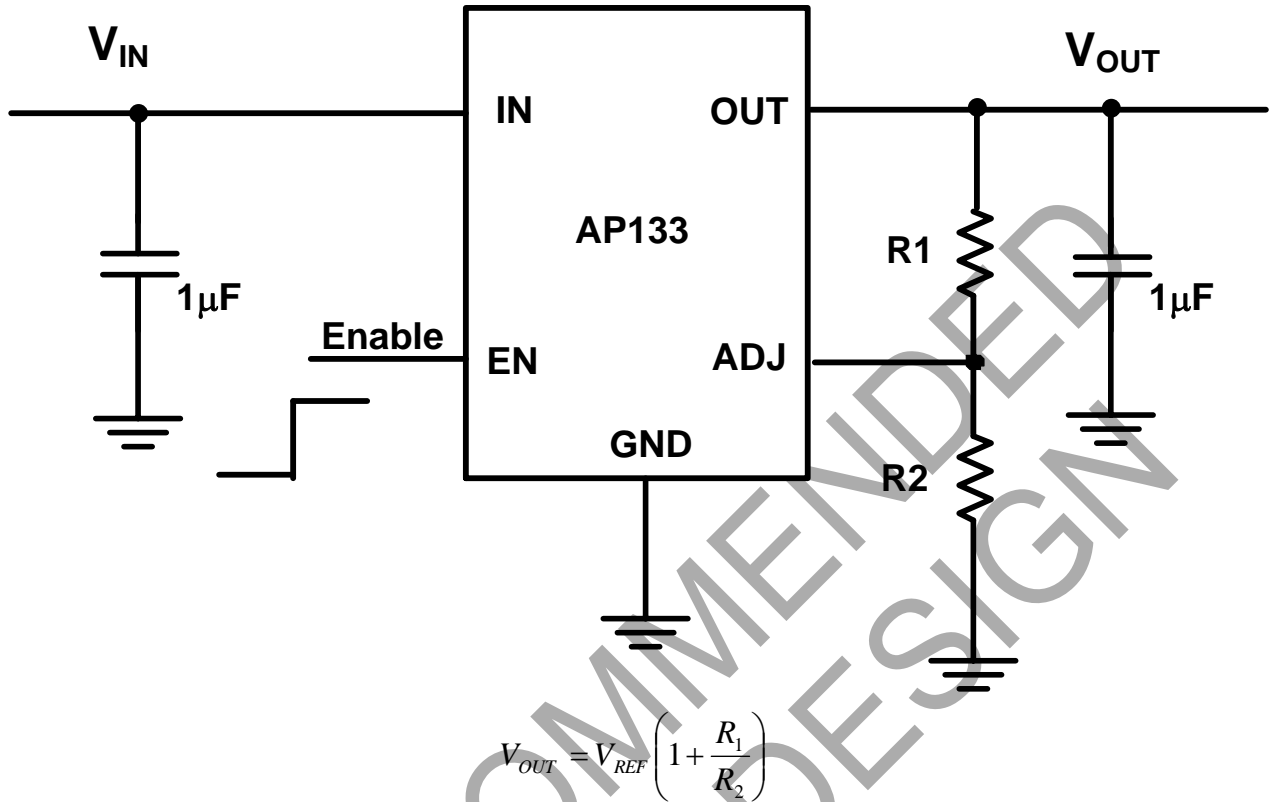

Pin Descriptions

Pin Number	Package Name		Function
	SOT25	DFN2020-6	
IN	1	3	Voltage input pin. Bypass to ground through at least 0.1µF capacitor
GND	2	2	Ground
EN	3	1	Enable input, active high
ADJ	4	6	Output feedback pin
NC	-	5	No connection
OUT	5	4	Voltage output pin. Bypass to ground through 1µF ceramic capacitor

Functional Block Diagram

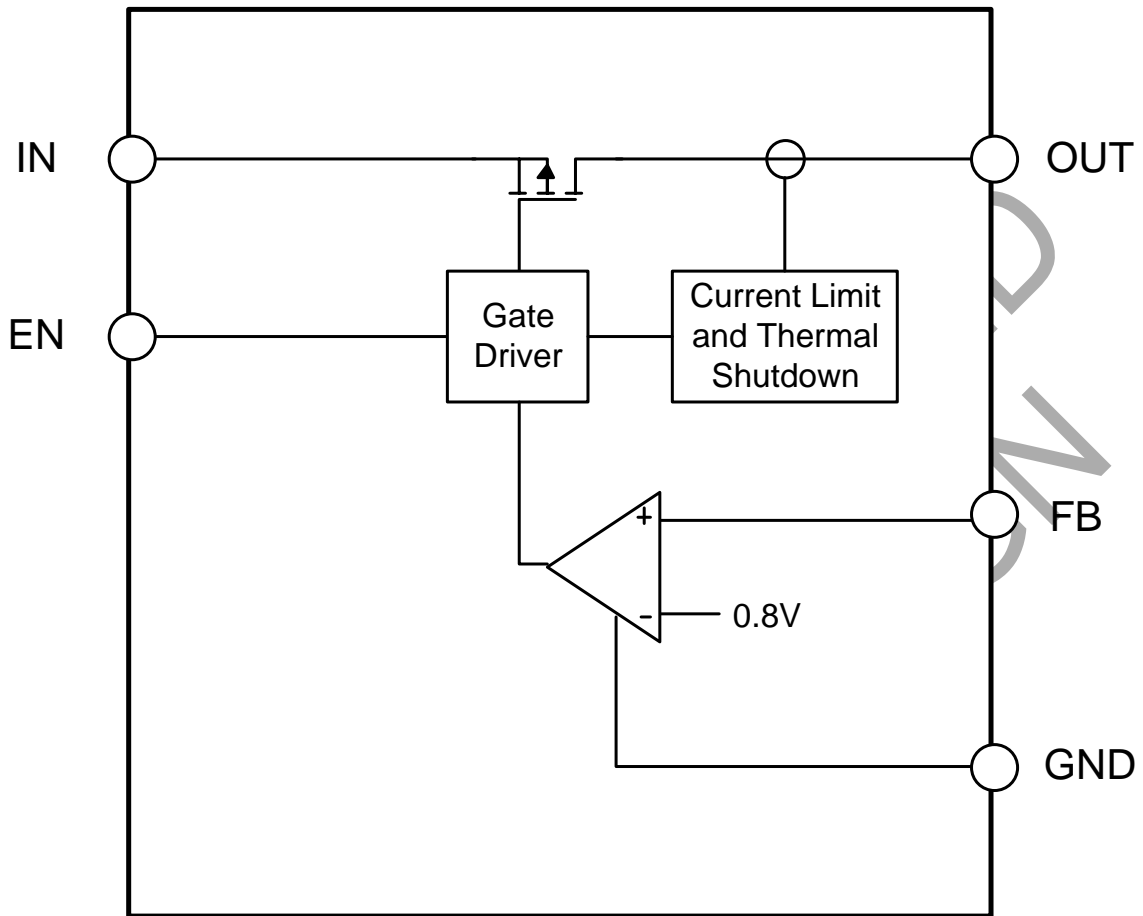

Absolute Maximum Ratings (@T_A = +25°C, unless otherwise specified.)

Symbol	Parameter	Ratings	Unit	
V _{IN}	Input Voltage	7	V	
-	OUT, ADJ, EN Voltage	V _{IN} + 0.3	V	
-	Continuous Load Current	Internal Limited	-	
T _{OP}	Operating Junction Temperature Range	-40 to +125	°C	
T _{ST}	Storage Temperature Range	-65 to +150	°C	
P _D	Power Dissipation (Note 4)	SOT25	740	mW
		DFN2020-6	900	mW
T _J	Maximum Junction Temperature	+150	°C	

Recommended Operating Conditions (@T_A = +25°C, unless otherwise specified.)

Symbol	Parameter	Min	Max	Unit
V _{IN}	Input voltage (Note 5)	2	6	V
I _{OUT}	Output Current	0	300	mA
T _A	Operating Ambient Temperature	-40	+85	°C

Notes: 4. Ratings apply to ambient temperature at +25°C.
5. At V_{IN} < 2.2V and T_A < -20°C, the output current capability may be reduced.

Electrical Characteristics (@T_A = +25°C, V_{IN} = V_{OUT} + 1V, C_{IN} = 1μF, C_{OUT} = 1μF, V_{EN} = 2V, unless otherwise specified.)

Symbol	Parameter	Test Conditions	Min	Typ.	Max	Unit	
I _Q	Input Quiescent Current	I _{OUT} = 0–300mA	-	40	60	μA	
I _{SHDN}	Input Shutdown Current	V _{EN} = 0V, I _{OUT} = 0	-	-	1	μA	
I _{LEAK}	Input Leakage Current	V _{EN} = 0V, OUT grounded	-	-	1	μA	
V _{Dropout}	Dropout Voltage	V _{OUT} ≥ 1.5V, I _{OUT} = 300mA	-	350	450	mV	
V _{REF}	ADJ reference voltage	I _{OUT} = 0	-	0.8	-	V	
I _{ADJ}	ADJ leakage	-	-	-	1	μA	
V _{OUT}	Output Voltage Accuracy	-	-2	-	2	%	
$\frac{\Delta V_{OUT}}{\Delta V_{IN}/V}$	Line Regulation	V _{IN} = V _{OUT} + 1V to 5.5V, I _{OUT} = 1mA	-	0.05	-	%/V	
$\frac{\Delta V_{OUT}}{I_{OUT}}$	Load Regulation	I _{OUT} from 1mA to 300mA	-1	-	1	%	
t _{ST}	Start-up Time	V _{EN} = 0V to 2.0V, I _{OUT} = 300mA	-	25	-	μs	
PSRR	PSRR	1kHz, I _{OUT} = 0mA	-	65	-	dB	
I _{SHORT}	Short-circuit Current	V _{IN} = 5.0V, V _{OUT} < 0.2V	-	120	-	mA	
I _{LIMIT}	Current limit	V _{OUT} = 3V, R _{OUT} = 3Ω	400	600	-	mA	
V _{IL}	EN Input Logic Low Voltage	-	-	-	0.4	V	
V _{IH}	EN Input Logic High Voltage	-	1.4	-	-	V	
I _{EN}	EN Input leakage	V _{EN} = 0V or 5.5V	-1	-	1	uA	
T _{SHDN}	Thermal shutdown threshold	-	-	+145	-	°C	
T _{HYS}	Thermal shutdown hysteresis	-	-	+20	-	°C	
θ _{JA}	Thermal Resistance Junction-to-Ambient	SOT25	Device mounted on FR-4 substrate, 2oz copper, with minimum recommended pad layout.	-	176	-	°C/W
		DFN2020-6		-	142	-	
θ _{JC}	Thermal Resistance Junction-to-Case	SOT25		-	41	-	°C/W
		DFN2020-6		-	36	-	

NOT RECOMMENDED FOR NEW DESIGN

Typical Performance Characteristics

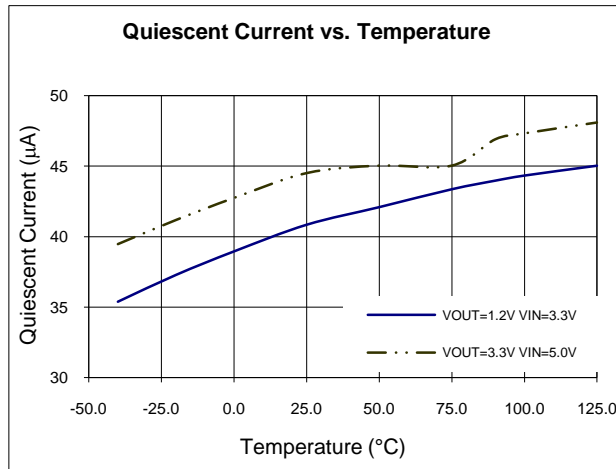
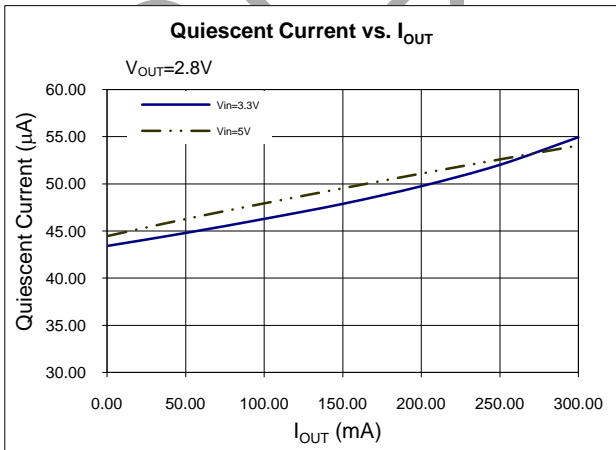
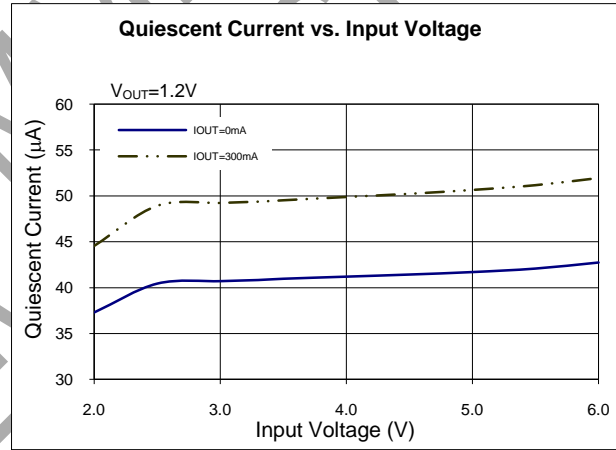
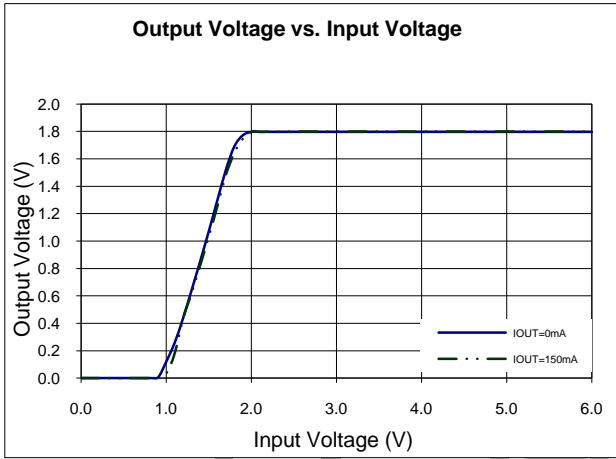
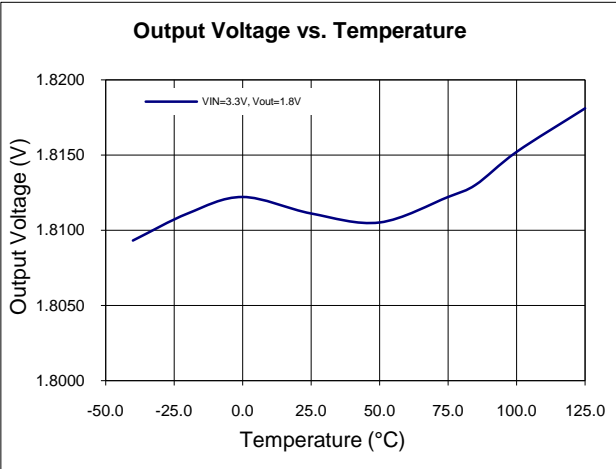
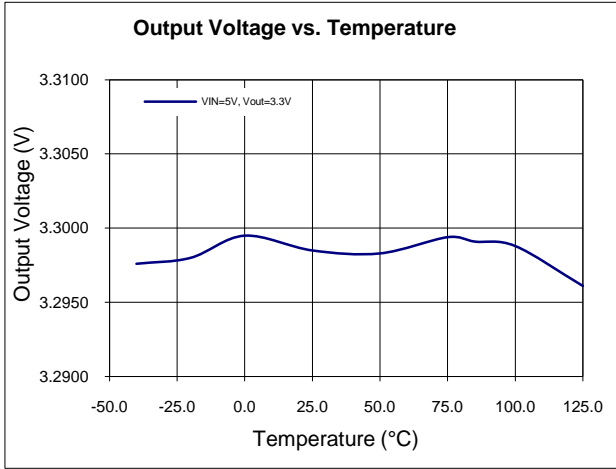

Typical Performance Characteristics

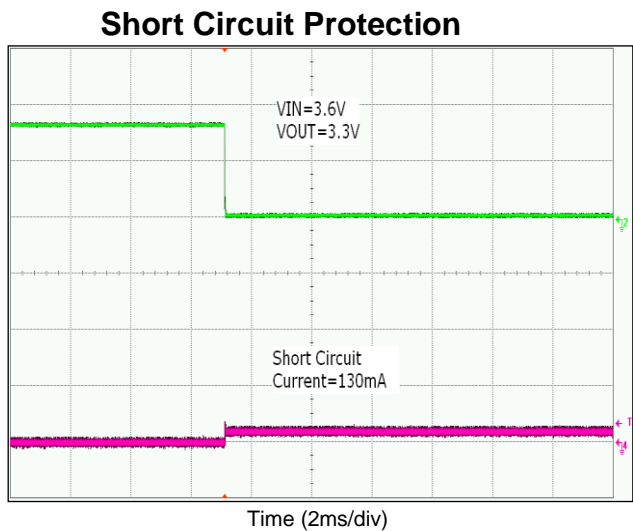
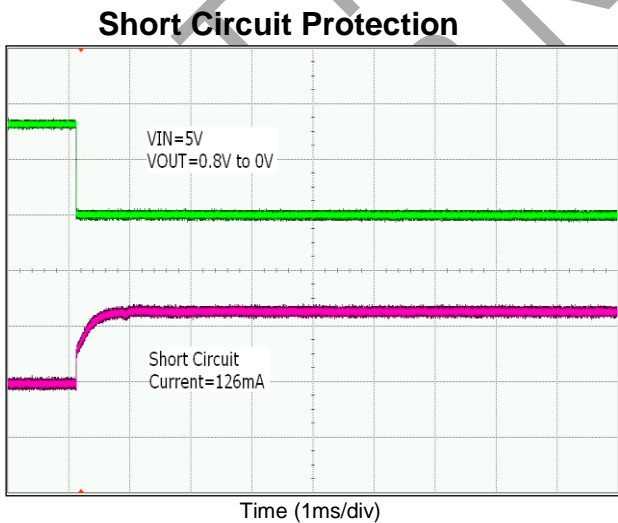
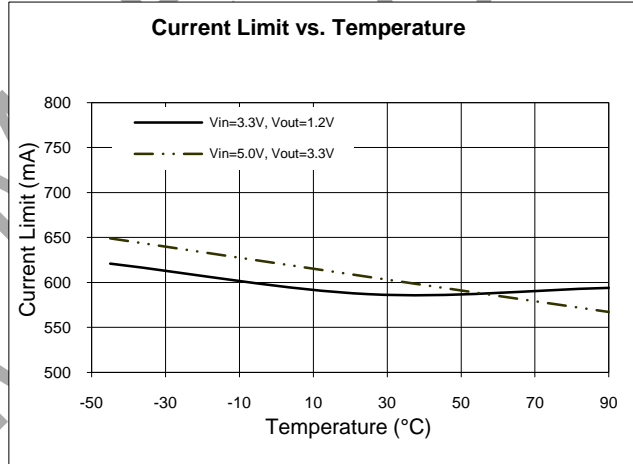
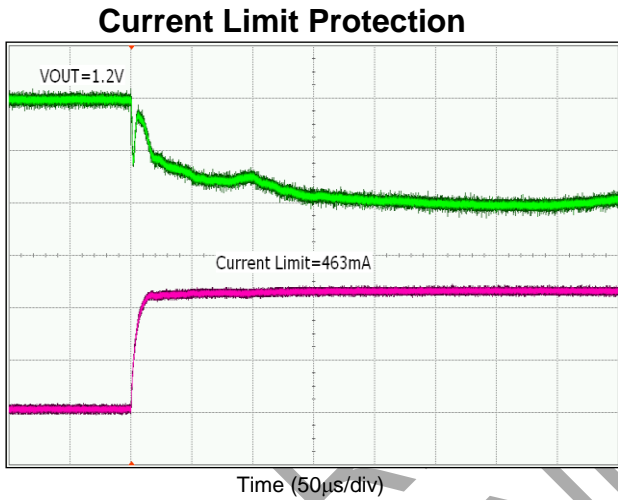
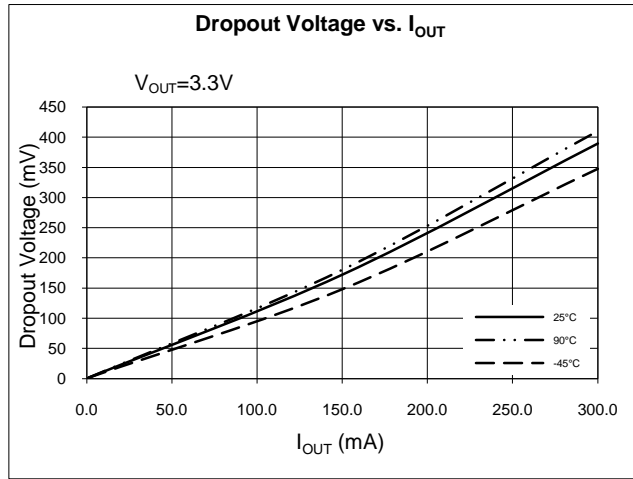
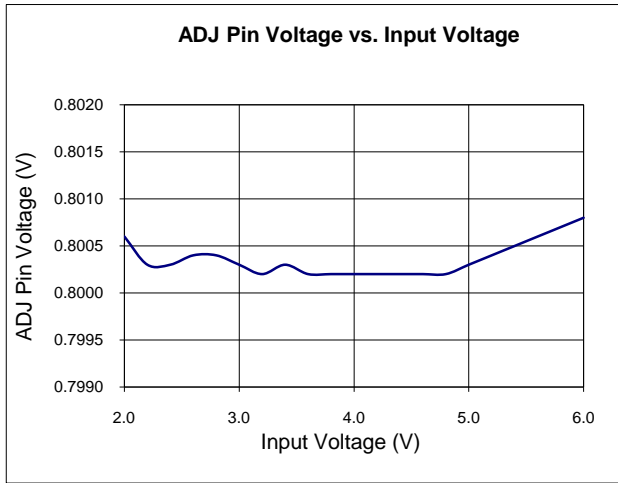

Typical Performance Characteristics

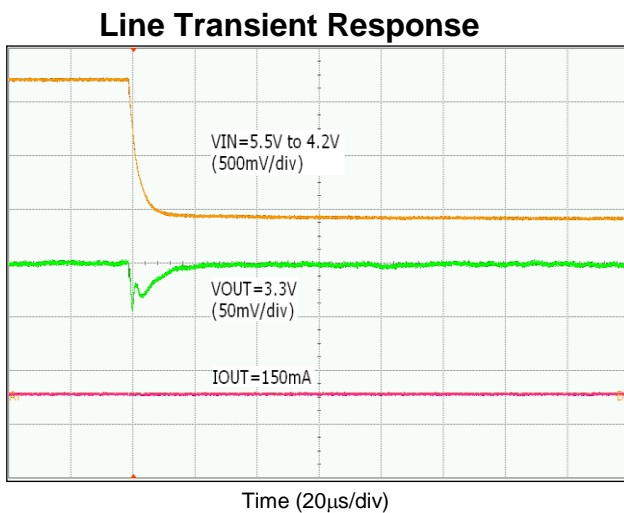
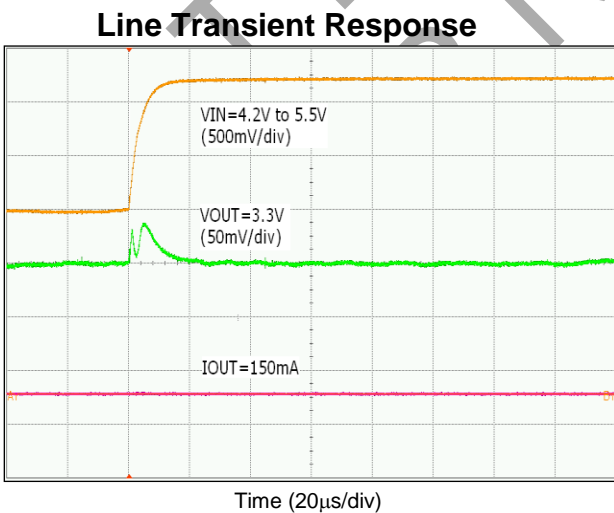
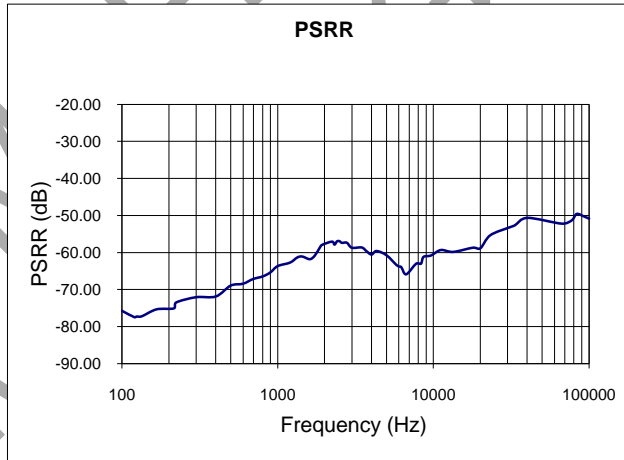
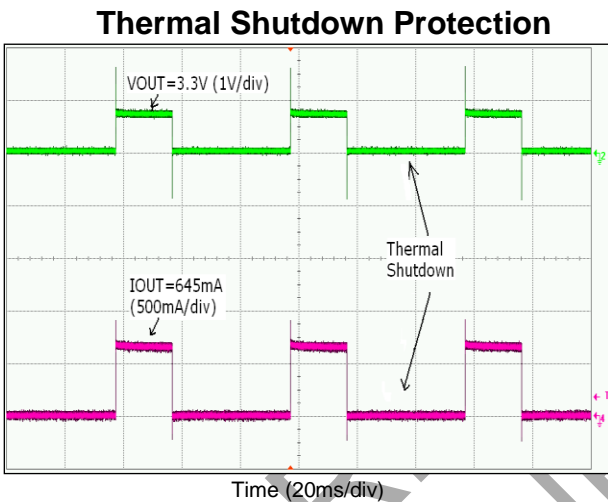
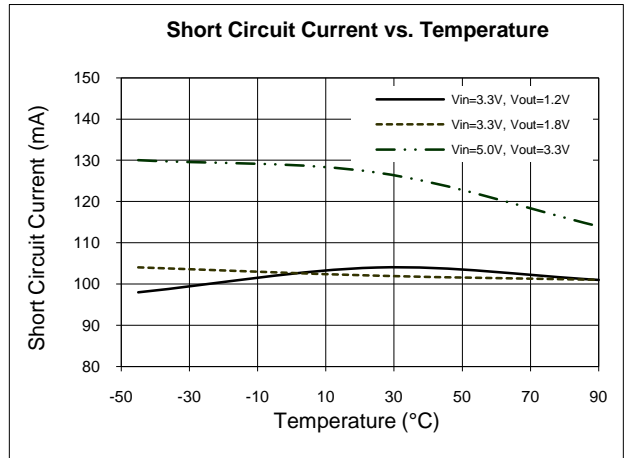
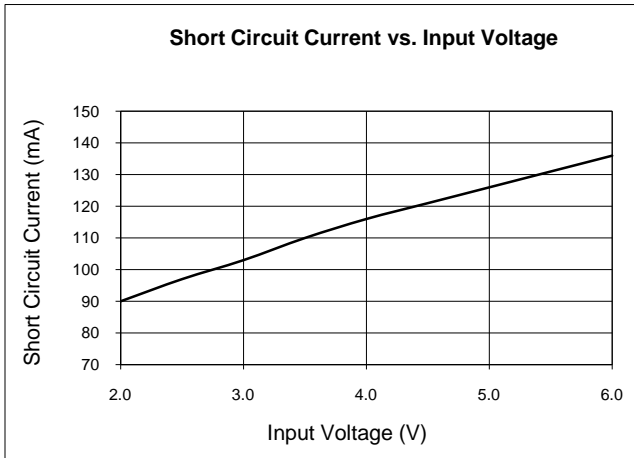

Typical Performance Characteristics

Line Transient Response

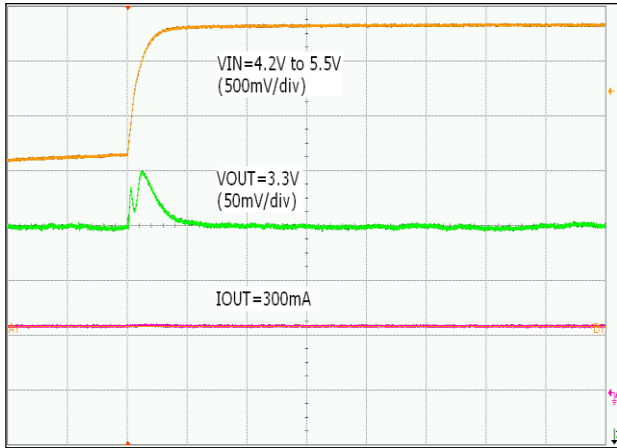

Time (20µs/div)

Line Transient Response

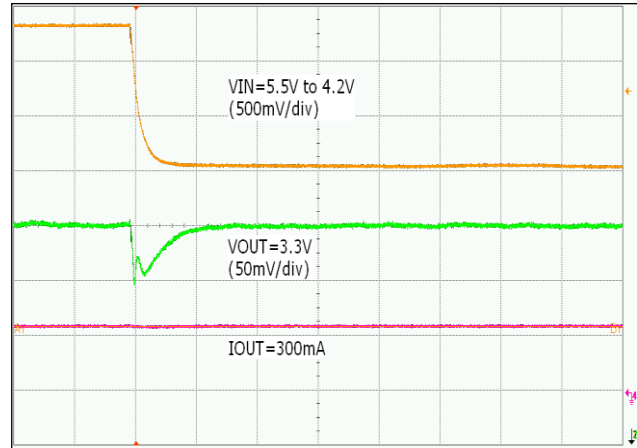

Time (20µs/div)

Load Transient Response

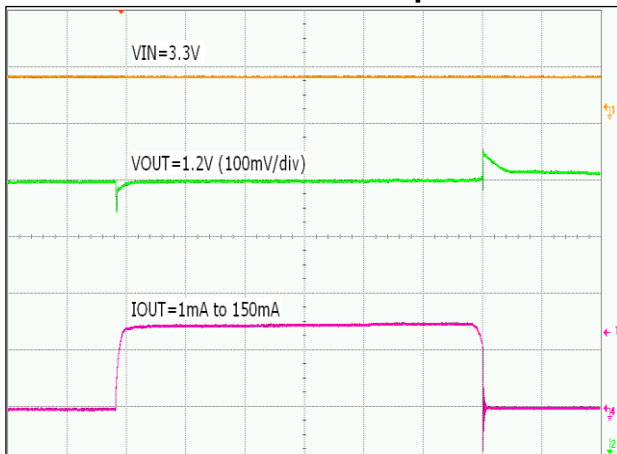

Time (100µs/div)

Load Transient Response

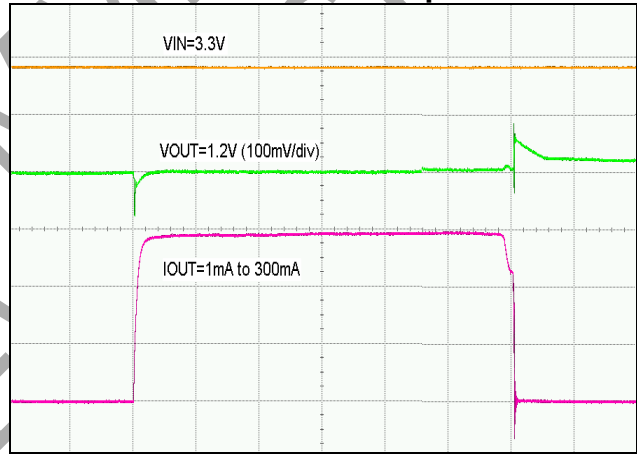

Time (100µs/div)

Load Transient Response

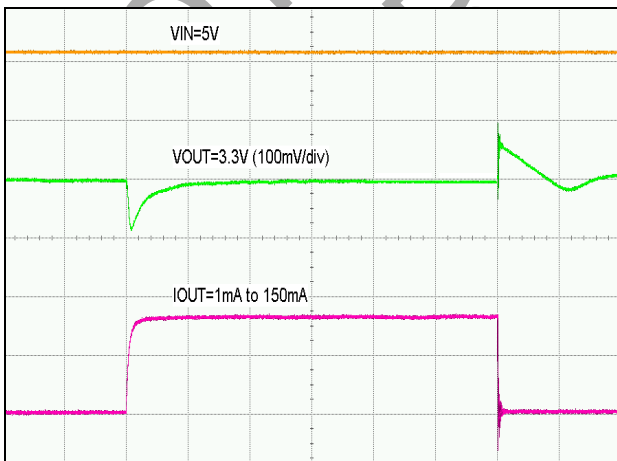

Time (20µs/div)

Load Transient Response

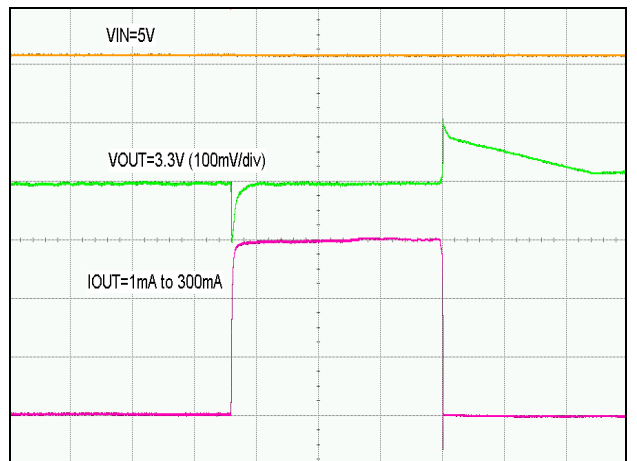

Time (100µs/div)

Typical Performance Characteristics

Start-up Time

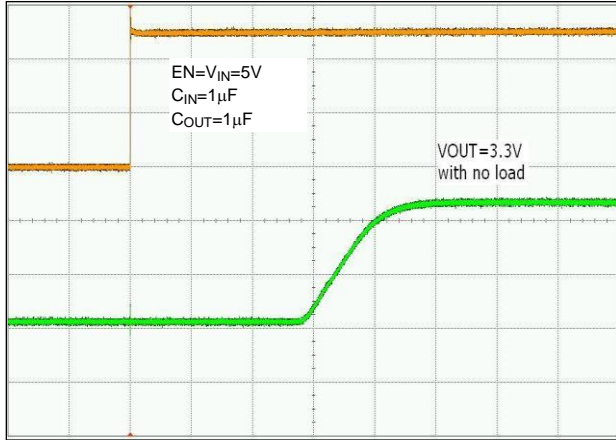

Time (5µs/div)

Start-up Time

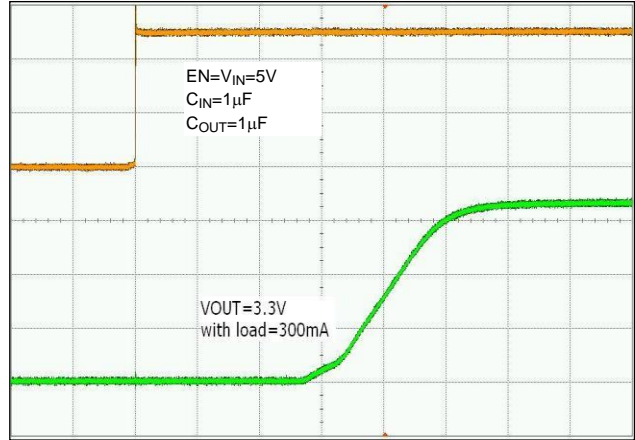

Time (5µs/div)

Start-up Time

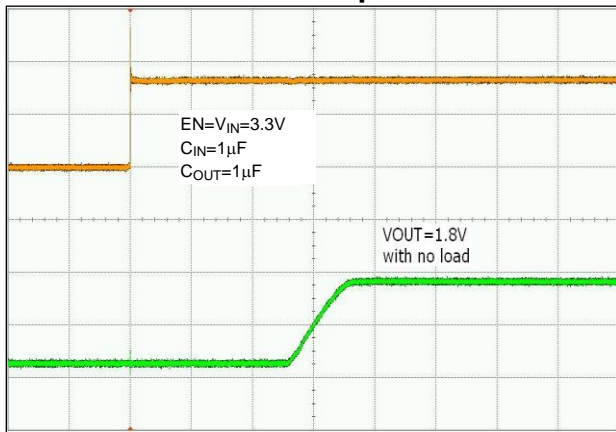

Time (5µs/div)

Start-up Time

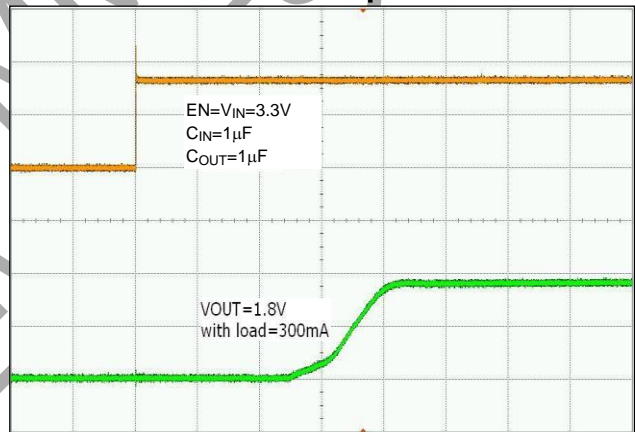

Time (5µs/div)

NOT FOR SALE

Application Note

Input Capacitor

A 1µF ceramic capacitor is recommended to connect between V_{IN} and GND pins to decouple input power supply glitch and noise. The amount of the capacitance may be increased without limit. This input capacitor must be located as close as possible to the device to assure input stability and less noise. For PCB layout, a wide copper trace is required for both V_{IN} and GND. A lower ESR capacitor allows the use of less capacitance, while higher ESR type requires more capacitance.

Output Capacitor

The output capacitor is required to stabilize and help transient response for LDO. The AP133 is stable with very small ceramic output capacitors. The recommended capacitance is from 1µF to 4.7µF, Equivalent Series Resistance (ESR) is from 10mΩ to 100mΩ, and temperature characteristic is X7R or X5R. Higher capacitance values help to improve load/line transient response. The output capacitance may be increased to keep low undershoot/overshoot. Place output capacitor as close as possible to OUT and GND pins, and keep the leads as short as possible.

Adjustable Operation

The AP133 provides output voltage from 1.0V to 5.0V through external resistor divider as shown below.

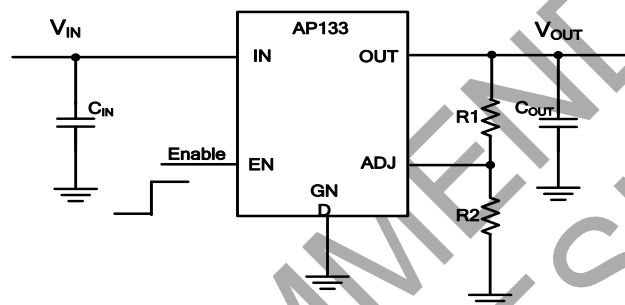

The output voltage is calculated by:

$$V_{OUT} = V_{REF} \left(1 + \frac{R_1}{R_2} \right)$$

Where $V_{REF}=0.8V$ (the internal reference voltage)

Rearranging the equation will give the following that is used for adjusting the output to a particular voltage:

$$R_1 = R_2 \left(\frac{V_{OUT}}{V_{REF}} - 1 \right)$$

To maintain the stability of the internal reference voltage, R_2 needs to be kept smaller than 250kΩ.

No Load Stability

Other than external resistor divider, no minimum load is required to keep the device stable. The device will remain stable and regulated in no load condition.

ON/OFF Input Operation

The AP133 is turned on by setting the EN pin high, and is turned off by pulling it low. If this feature is not used, the EN pin should be tied to IN pin to keep the regulator output on at all time. To ensure proper operation, the signal source used to drive the EN pin must be able to swing above and below the specified turn-on/off voltage thresholds listed in the Electrical Characteristics section under V_{IL} and V_{IH} .

Current Limit Protection

When output current at OUT pin is higher than current limit threshold, the current limit protection will be triggered and clamp the output current to approximately 600mA to prevent over-current and to protect the regulator from damage due to overheating.

Short Circuit Protection

When OUT pin is short-circuit to GND or OUT pin voltage is less than 200mV, short circuit protection will be triggered and clamp the output current to approximately 120mA. This feature protects the regulator from over-current and damage due to overheating.

Thermal Shutdown Protection

Thermal protection disables the output when the junction temperature rises to approximately +145°C, allowing the device to cool down. When the junction temperature reduces to approximately +125°C the output circuitry is enabled again. Depending on power dissipation, thermal resistance, and ambient temperature, the thermal protection circuit may cycle on and off. This cycling limits the heat dissipation of the regulator, protecting it from damage due to overheating.

Application Note (Cont.)

Ultra Fast Start-up

After enabled, the AP133 is able to provide full power in as little as tens of microseconds, typically 25 μ s, without sacrificing low ground current. This feature will help load circuitry move in and out of standby mode in real time, eventually extend battery life for mobile phones and other portable devices.

Fast Transient Response

Fast transient response LDOs can also extend battery life. TDMA-based cell phone protocols such as Global System for Mobile Communications (GSM) have a transmit/receive duty factor of only 12.5 percent, enabling power savings by putting much of the baseband circuitry into standby mode in between transmit cycles. In baseband circuits, the load often transitions virtually instantaneously from 100 μ A to 100mA. To meet this load requirement, the LDO must react very quickly without a large voltage drop or overshoot — a requirement that cannot be met with conventional, general-purpose LDOs.

The AP133's fast transient response from 0 to 300mA provides stable voltage supply for fast DSP and GSM chipset with fast changing load.

Small Overshoot and Undershoot

The AP133 has small and controlled overshoot and undershoot in load and line transitions. This helps to protect supplied circuit from damage and operation error caused by glitches. This feature also permits the usage of small value output decoupling capacitor with AP133.

Low Quiescent Current

Cellular phone baseband internal digital circuits typically operate from 1.8V to 2.6V. When the Li+ battery voltage falls to 3.2 to 3.3V, most phones shut off, giving at least 500-600mV of headroom for the baseband digital LDO, so dropout is not critical. Output noise and the PSRR are not critical specs for the digital circuits. Nonetheless, this supply requires low quiescent current at light loads because this LDO stays on at all times. Figure below shows how the digital supply current of a representative GSM chipset core varies as a function of time.

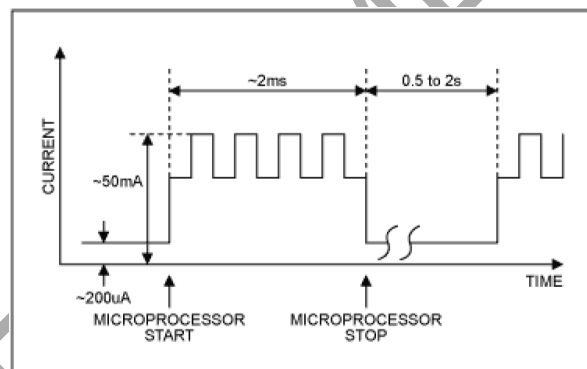

In the standby mode, the microprocessor consumes only around 200 μ A. Since the phone stays in standby for the longest percentage of time, using a 40 μ A quiescent current LDO, instead of 140 μ A, saves 100 μ A and extends the standby time by 340 μ A/240 μ A, or 1.417 times.

The baseband internal analog circuit is typically 2.4V-3.0V, and it requires 200-600mV dropout. This LDO is on all the time, so it requires low quiescent current as well. The cellular phone real-time clock LDO needs a very low quiescent current, since this LDO is on all the time even though the handset is powered off.

The AP133, consuming only around 40 μ A for all input range and output loading, provides great power saving in portable and low power applications.

Wide Output Range

The AP133, with a wide output range of 1.0V to 5.0V, provides a versatile LDO solution for many portable applications.

High PSRR

The RF circuit consists of receive and transmit sections, which typically require 2.6V-3.0V supply voltage. The RF circuits such as LNA (low-noise amplifier), up/down-converter, mixer, PLL, VCO, and IF stage, require low noise and high PSRR LDOs. The temperature-compensated crystal oscillator circuit requires very high PSRR at RF power amplifier burst frequency. For instance, minimum 65dB PSRR at 217Hz is recommended for the GSM handsets.

In order to provide good audio quality, the audio power supply for hand-free, game, MP3, and multimedia applications in cellular phones, require low-noise and high PSRR at audio frequency range (20Hz to 20kHz).

The AP133, with PSRR of 70dB at 1kHz in best case, is suitable for some of these applications that require high PSRR.

Ordering Information

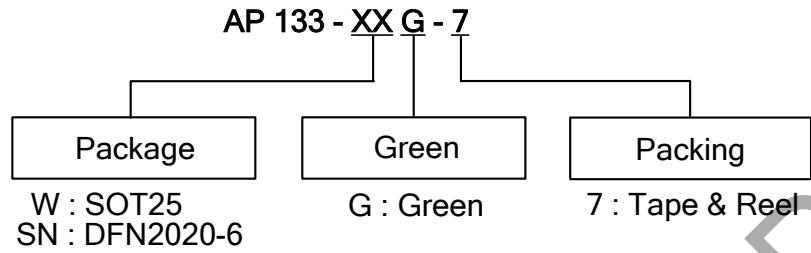

Device	Package Code	Packaging (Note 6)	7" Tape and Reel	
			Quantity	Part Number Suffix
AP133-WG-7	W	SOT25	3000/Tape & Reel	-7
AP133-SNG-7	SN	DFN2020-6	3000/Tape & Reel	-7

Note: 6. Pad layout as shown on Diodes Incorporated's suggested pad layout document, which can be found on our website at <http://www.diodes.com/package-outlines.html>.

NOT RECOMMENDED FOR NEW DESIGN

Marking Information

(1) SOT25

(Top View)

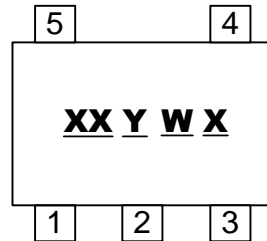

XX : Identification code
Y : Year 0~9
W : Week : A~Z : 1~26 week;
 a~z : 27~52 week; z represents
 52 and 53 week
X : A~Z : Green

Part Number	Package	Identification Code
AP133-WG-7	SOT25	NB

(2) DFN2020-6

(Top View)

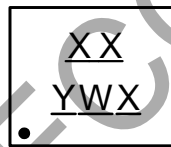

XX : Identification Code
Y : Year : 0~9
W : Week : A~Z : 1~26 week;
 a~z : 27~52 week; z represents
 52 and 53 week
X : A~Z : Green

Part Number	Package	Identification Code
AP133-SNG-7	DFN2020-6	NB

Package Outline Dimensions (All dimensions in mm.)

(1) Package Type: SOT25

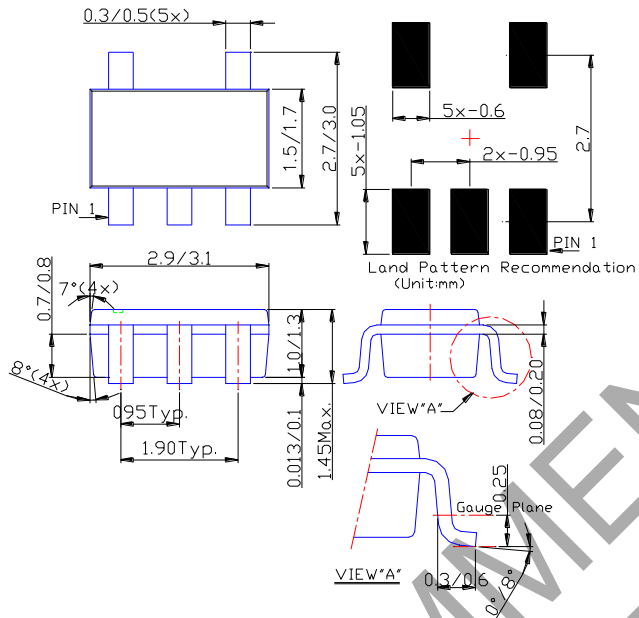

(2) Package Type: DFN2020-6

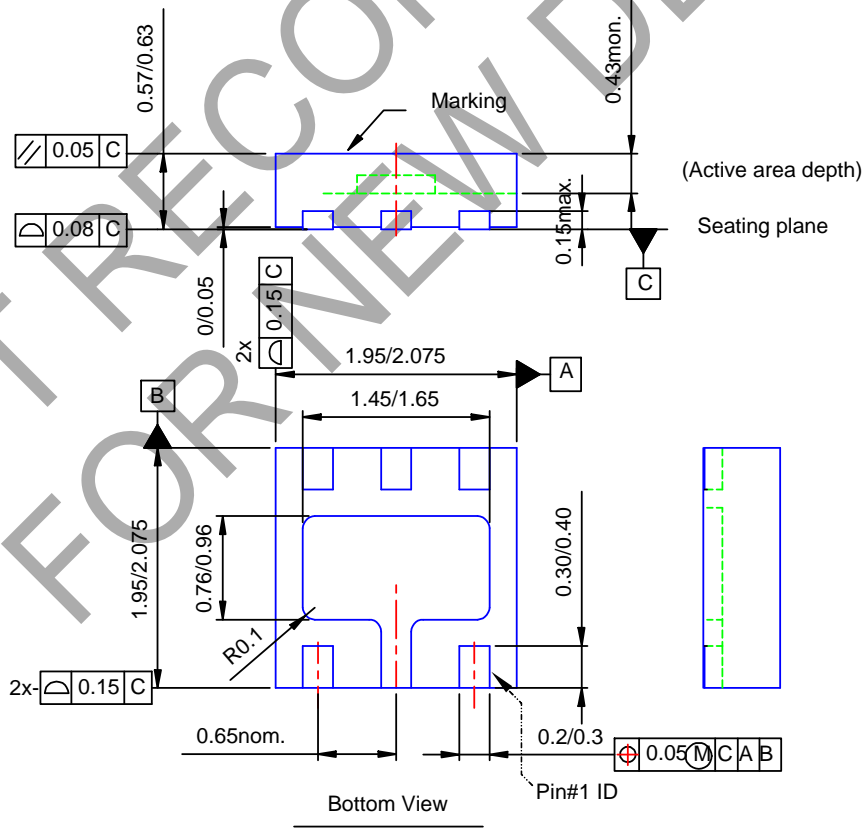

Taping Orientation (Note 7)

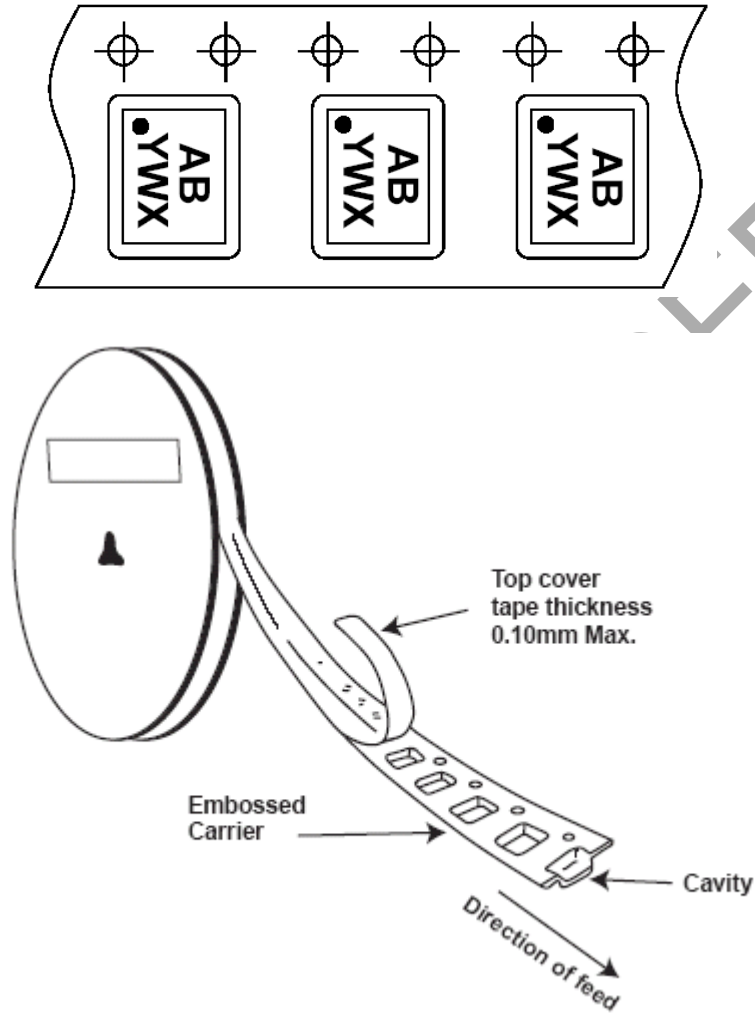

Note: 7. The taping orientation of the other package type can be found on our website at <http://www.diodes.com/datasheets/ap02007.pdf>.

IMPORTANT NOTICE

DIODES INCORPORATED MAKES NO WARRANTY OF ANY KIND, EXPRESS OR IMPLIED, WITH REGARDS TO THIS DOCUMENT, INCLUDING, BUT NOT LIMITED TO, THE IMPLIED WARRANTIES OF MERCHANTABILITY AND FITNESS FOR A PARTICULAR PURPOSE (AND THEIR EQUIVALENTS UNDER THE LAWS OF ANY JURISDICTION).

Diodes Incorporated and its subsidiaries reserve the right to make modifications, enhancements, improvements, corrections or other changes without further notice to this document and any product described herein. Diodes Incorporated does not assume any liability arising out of the application or use of this document or any product described herein; neither does Diodes Incorporated convey any license under its patent or trademark rights, nor the rights of others. Any Customer or user of this document or products described herein in such applications shall assume all risks of such use and will agree to hold Diodes Incorporated and all the companies whose products are represented on Diodes Incorporated website, harmless against all damages.

Diodes Incorporated does not warrant or accept any liability whatsoever in respect of any products purchased through unauthorized sales channel. Should Customers purchase or use Diodes Incorporated products for any unintended or unauthorized application, Customers shall indemnify and hold Diodes Incorporated and its representatives harmless against all claims, damages, expenses, and attorney fees arising out of, directly or indirectly, any claim of personal injury or death associated with such unintended or unauthorized application.

Products described herein may be covered by one or more United States, international or foreign patents pending. Product names and markings noted herein may also be covered by one or more United States, international or foreign trademarks.

This document is written in English but may be translated into multiple languages for reference. Only the English version of this document is the final and determinative format released by Diodes Incorporated.

LIFE SUPPORT

Diodes Incorporated products are specifically not authorized for use as critical components in life support devices or systems without the express written approval of the Chief Executive Officer of Diodes Incorporated. As used herein:

A. Life support devices or systems are devices or systems which:

1. are intended to implant into the body, or
2. support or sustain life and whose failure to perform when properly used in accordance with instructions for use provided in the labeling can be reasonably expected to result in significant injury to the user.

B. A critical component is any component in a life support device or system whose failure to perform can be reasonably expected to cause the failure of the life support device or to affect its safety or effectiveness.

Customers represent that they have all necessary expertise in the safety and regulatory ramifications of their life support devices or systems, and acknowledge and agree that they are solely responsible for all legal, regulatory and safety-related requirements concerning their products and any use of Diodes Incorporated products in such safety-critical, life support devices or systems, notwithstanding any devices- or systems-related information or support that may be provided by Diodes Incorporated. Further, Customers must fully indemnify Diodes Incorporated and its representatives against any damages arising out of the use of Diodes Incorporated products in such safety-critical, life support devices or systems.

Copyright © 2018, Diodes Incorporated

www.diodes.com

Looking for pricing, stock, or lifecycle information?

Click below to explore more details on WIN SOURCE:

 [View AP133-SNG-7 on WIN SOURCE](#)

 [Diodes Incorporated](#) Information

Optimize Your Supply Chain with WIN SOURCE Solutions

-  Global Sourcing Solution
-  Obsolete Management
-  Cost Control Management
-  Shortage Management
-  Alternative Solution
-  Excess Inventory Management