



**THE DATASHEET OF
RI-TRP-RRHP-20**



23-mm Glass Encapsulated Transponder

Reference Guide

July 1996

TIRIS *Technology by
Texas Instruments™*

23-mm Glass Encapsulated Transponder

Reference Guide

TIRIS *Technology by
Texas Instruments™*

Literature Number: SCBU018
July 1996

Contents

1	Introduction	6
2	Transponder Packaging	6
3	Product Codes	7
4	Function	7
	4.1 Read (Reading of RO and R/W Transponders).....	7
	4.2 Write and Program.....	9
5	Characteristics of the Pulsed FM System	11
	5.1 Basic System Data	11
	5.2 Reader and System Design Impact.....	11
	5.3 System Performance and Functional Reliability Impact.....	11
	5.4 Other Quality Factors of the TIRIS Pulsed FM System	12
6	EMI/EMC Performance	12
	6.1 General	12
	6.2 The Automotive Environment and Factors	12
	6.3 TIRIS Pulsed FM Transponder and System Performance	12
7	Measurement Set-Ups	14
	7.1 Measurement Set-Up: Resonance Frequency, Bandwidth, Quality Factor of Transponder.....	14
	7.2 Measurement Set-Up: Powering Field Strength	16
	7.3 Measurement Set-Up: Transponder Signal Strength	17
8	Absolute Maximum Ratings	18
9	Recommended Operating Conditions	18
10	Characteristics	18
11	Environmental Data and Reliability	19
12	Memory	19
13	Package	19
14	Packing Symbolization	20
	Appendix A Conversion Formula	21

List of Figures

1	System Configuration Showing the Reader, Antenna, and Transponder	6
2	Block Diagram of the TIRIS Pulsed FM Transponder	6
3	Dimensions of the TIRIS 23-mm Transponder (in mm).....	7
4	Charge and Read Function of the Transponder, Showing the Voltage at the Transponder and Exciter (Reader) Coil	8
5	FM Principle Used for the Read Function of TIRIS Transponders	8
6	Read Data Format of TIRIS RO Transponder	9
7	Read Data Format of TIRIS R/W Transponder	9
8	Charge, Write, and Program Principle Used for TIRIS, Showing the Voltage at the Exciter (Reader) and Transponder Antenna Coil	10
9	The Write and Program Function	10
10	Write Data Format for Programming Function	11
11	EMI Performance Test of the TIRIS System.....	13
12	EMI Performance at Commonly Used Radio Communication Frequencies in Automotive Environment.....	13
13	Reading Range Under Broadband Noise (White Noise) Conditions	14
14	Measurement Set-up For the Determination of Transponder Resonance Frequency, Bandwidth, and Quality Factor	15
15	Determination of the Resonance Frequency and –3-dB Bandwidth by Monitoring the Pick-up Coil Voltage ..	15
16	Test Set-up For Powering Field Strength Determination.....	16
17	Received Signal at the Pickup Coil, If Power Field Strength Is Sufficient	17
18	Determination of the Transponder Signal Strength (Data Transmission Signal Strength) With Helmholtz Aperture	17
19	Monitored Signal Voltage at the Spectrum Analyzer (Time Domain Mode)	18

Edition Notice: Fourth Edition – July 1996

This is the fourth edition of this manual, it describes the following transponders:

RI-TRP-RRHP

RI-TRP-WRHP

This Reference Manual is for customers who wish to use the TIRIS 23-mm Glass Encapsulated Transponder in Radio Frequency Identification (RFID) installations. The manual includes technical information concerning the function, technical specifications, application and environmental related data.

Texas Instruments reserves the right to change its products or services at any time without notice. TI provides customer assistance in various technical areas, but does not have full access to data concerning the uses and applications of customer's products. Therefore TI assumes no responsibility for customer product design or for infringement of patents and/or the rights of third parties, which may result from assistance provided by TI.

The TIRIS™ logo and the word TIRIS™ are registered trademarks of Texas Instruments Incorporated.

Copyright © 1996 Texas Instruments Incorporated.

All rights reserved.

1 Introduction

The TIRIS 23-mm Glass Encapsulated Pulsed FM Transponder is a key product in low frequency RFID systems that can be used for a variety of applications, such as automotive security systems.

The device is available in Read Only (RO) and Read/Write (R/W) versions. Electro Magnetic signals are used to power the passive (batteryless) device, to transmit the identification number to a reader unit or to program the device with new data. The basic principle is described in [Figure 1](#).

Both RO and R/W versions use an 80 bit non-volatile memory (EEPROM) for storage of 64 identification bits and a 16 bit Block Check Character (BCC). The RO type is factory programmed with a unique tamperproof code that cannot be altered. The R/W version can be programmed by the user.

The 23-mm transponder comprises a ferrite core antenna, a charge capacitor, a resonance capacitor and the integrated circuit ([Figure 2](#)). The antenna inductance and the resonance capacitor form a high quality resonant circuit.

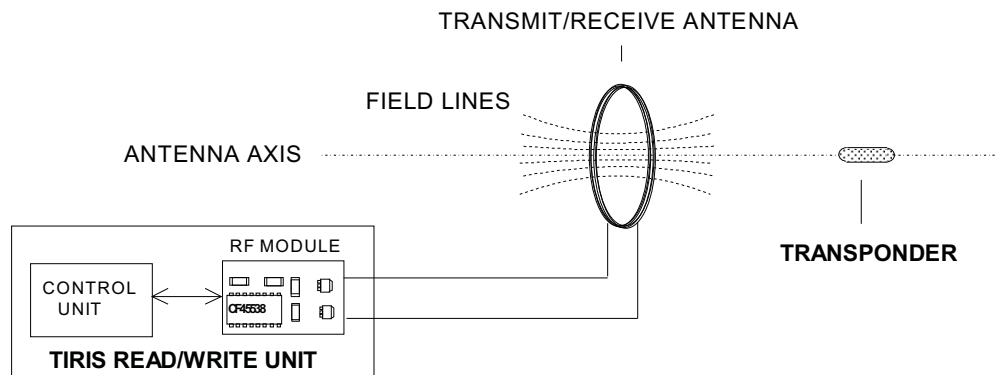

Figure 1. System Configuration Showing the Reader, Antenna, and Transponder

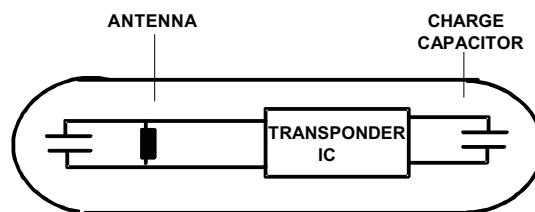

Figure 2. Block Diagram of the TIRIS Pulsed FM Transponder

2 Transponder Packaging

The dimensions of the transponder are given in [Figure 3](#).

The 23-mm shape offers several advantages:

- The transponder is hermetically sealed.
- The transponder is robustly constructed to withstand vibration (IEC68-2-6) and shock (IEC68-2-6).

- For applications where read range is not the most critical point the transponder can be mounted or used in such a way that the orientation is not controlled.

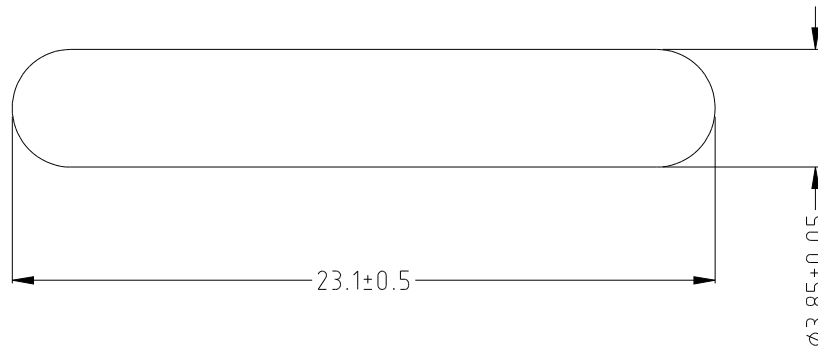

Figure 3. Dimensions of the TIRIS 23-mm Transponder (in mm)

3 Product Codes

64-bit Read Only device: RI-TRP-RRHP

64-bit Read/Write device: RI-TRP-WRHP

4 Function

The Pulsed FM System uses a sequential function principle separating the transponder powering (charge) and transponder data transmission mode. The advantages of the sequential mode are described in Section 5.1, "Basic System Data".

4.1 Read (Reading of RO and R/W Transponders)

During the charge (or powering phase) of between 15 and 50 ms the interrogator generates an electromagnetic field using a frequency of 134.2 kHz. The resonant circuit of the transponder is energized and the induced voltage is rectified by the integrated circuit to charge the capacitor. The transponder detects the end of the charge burst and transmits its data using Frequency Shift Keying (FSK), utilizing the energy stored in the capacitor.

The typical data low bit frequency is 134.2 kHz, the typical data high bit frequency is 123.2 kHz. The low and high bits have different durations, because each bit takes 16 RF cycles to transmit. The high bit has a typical duration of 130 μ s, the low bit of 119 μ s. [Figure 5](#) shows the FM principle used. Regardless of the number of low and high bits, the transponder response duration is always less than 20 ms.

The data format consists of 128 bits. Different start/stop bytes and end bits are used, to allow secure distinction between RO and R/W Transponder. [Figure 6](#) and [Figure 7](#) show the format of the received data for RO and R/W transponders.

After transmission of the data format the capacitor is discharged. The typical transponder readout timing is described in [Figure 4](#). The charge phase is followed directly by the read phase (RO mode).

Data encoding is done in NRZ mode (Non Return to Zero). The clock is derived from the RF carrier by a divide-by-16 function.

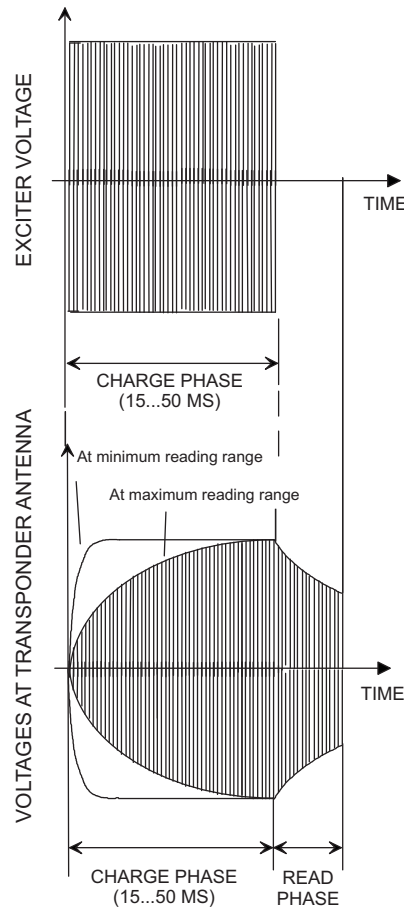

Figure 4. Charge and Read Function of the Transponder, Showing the Voltage at the Transponder and Exciter (Reader) Coil

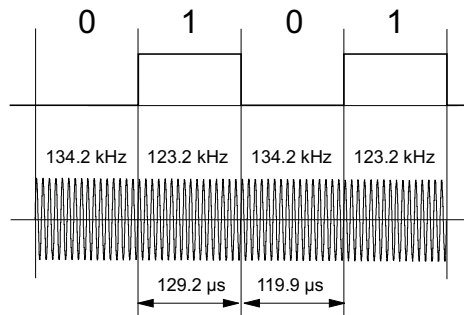

Figure 5. FM Principle Used for the Read Function of TIRIS Transponders

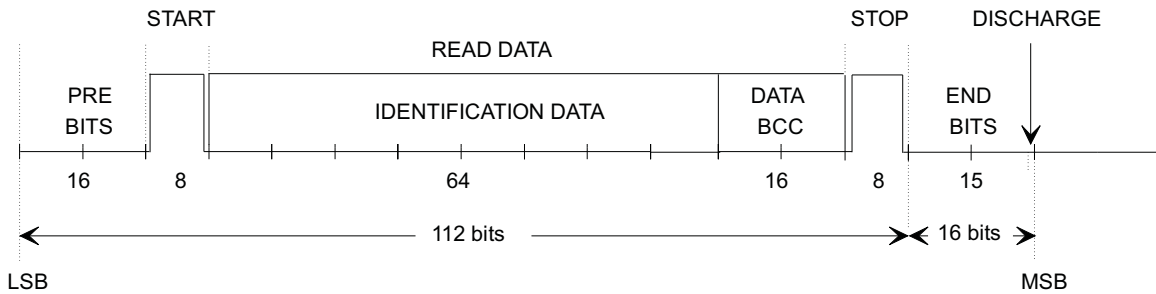

Figure 6. Read Data Format of TIRIS RO Transponder

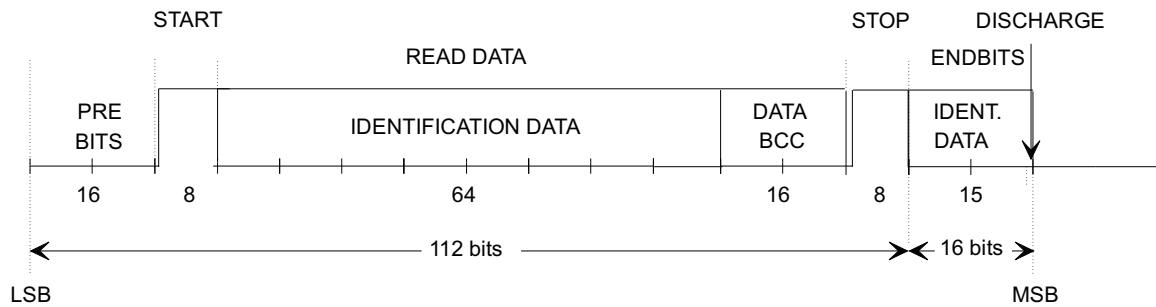
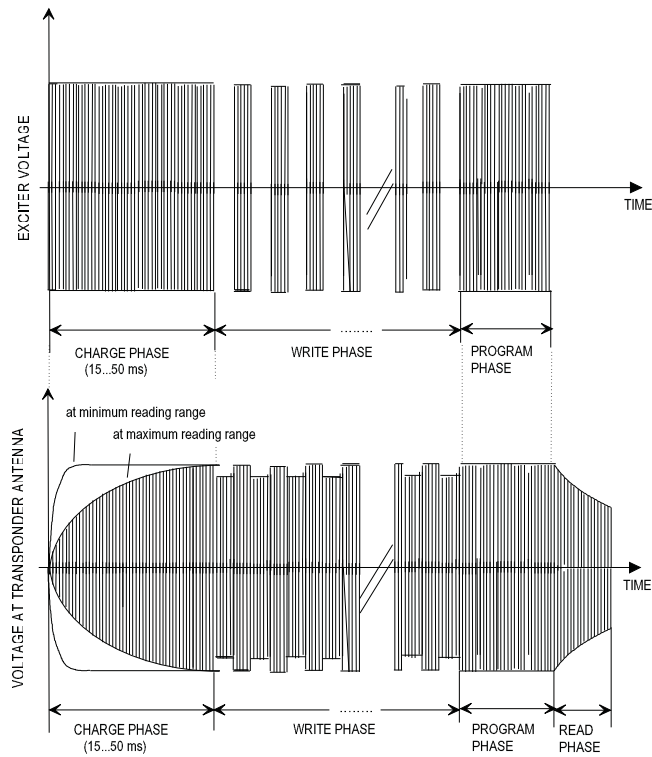

Figure 7. Read Data Format of TIRIS R/W Transponder

4.2 Write and Program

A new identification number can be written (programmed) into a R/W transponders in the following manner: After the charge phase the R/W transponder enters the write mode providing the reader starts to modulate the field by switching the transmitter on and off (TXCT-). Modulation index of this amplitude modulation is 100%. The duration of the off-phase defines whether a low bit or a high bit is being transmitted (Pulse Width Modulation). Writing means, the transponder shifts the received bits into a shift register. After the write phase the reader's transmitter is switched on for a certain time (programming time) in order to energize the process of programming the shift register data into the EEPROM. All 80 bits are programmed simultaneously into the EEPROM. Once the data is programmed into the EEPROM the transponder automatically sends back the captured data to the reader to allow a security check, this process takes place when the transmitter is switched off. Each read unit can be used as a write unit through software change only. No hardware changes are required.

Figure 8 describes the write function by showing the transmitter (reader) RF output signal and the transponder RF input signal. Figure 9 shows the TXCT- signal of the reader (transmitter) during the write and program function. The data transmission format of the write mode is described in Figure 10.



Charge: Continuous RF Module Transmitter output Signal
 Write: Pulse width modulation of the RF module transmitter output signal
 Program: Continuous RF module transmitter output signal
 Read: Frequency Shift Keying of the transponder resonant circuit oscillation

Figure 8. Charge, Write, and Program Principle Used for TIRIS, Showing the Voltage at the Exciter (Reader) and Transponder Antenna Coil

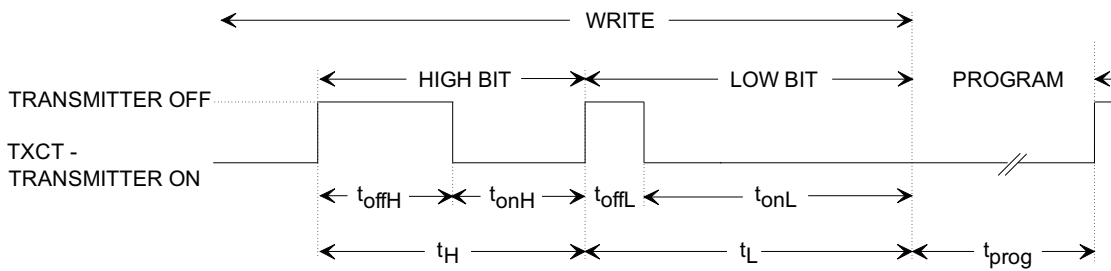

Figure 9. The Write and Program Function

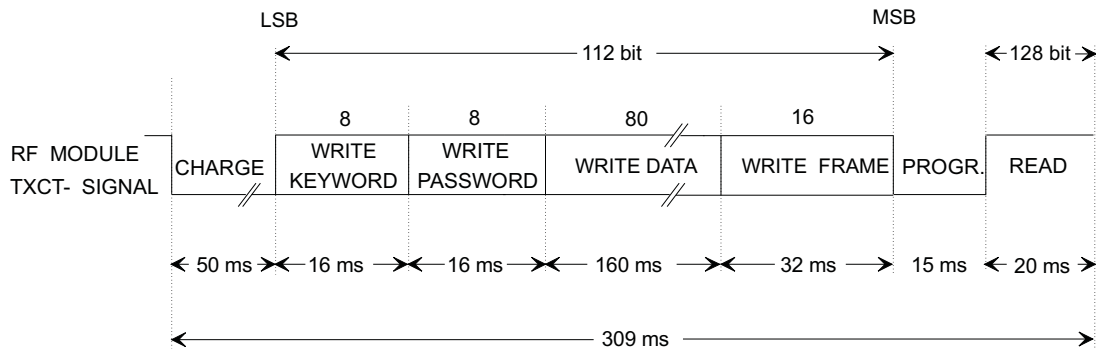

Figure 10. Write Data Format for Programming Function

5 Characteristics of the Pulsed FM System

5.1 Basic System Data

The TIRIS Pulsed FM system multiplexes the power and read functions avoiding compromises. This results in the following characteristics and options:

- Individual optimization of the power and read functions by the system designer.
- Variation of powering time by S/W to tradeoff speed/current consumption with other parameters
- Absence of the high powering signal during the data reception phase
- Data transmission by an active oscillator. This is associated with a high signal strength level and a high transponder efficiency.
- NRZ modulation encoding for high data speed and low transmission bandwidth

5.2 Reader and System Design Impact

- Ease of receiver and power function design and the optimization of performance due to sequential power/read functions.
- Low field strength for transponder charge, resulting in lower cost of the power function
- Optional performance and cost tradeoffs by variation of:
 - Interrogation speed by software down to 35 ms.
 - Component selection to achieve different EMI performance levels.

5.3 System Performance and Functional Reliability Impact

- Inherent EMI robustness and high system Signal/Noise ratio because
 - The transponder emits 6 dB to 20 dB higher data signal (compared to conventional systems).
 - The powering phase is noise immune and the data transmission phase duration is typically 16 ms.
 - FSK and NRZ allow a high data rate (typically 9 kbit/s).
 - Modulation is direct carrier FSK which has inherent AM noise suppression.
- Low reader power dissipation because of low charge field strength.
- Low power consumption due to pulsed operation (=low peak power × low duty cycle).
- Data telegram transmission is secured by 16 bit CRC-CCITT error detection protocol.
- The receive time is short, because the transponder protocol always starts at the beginning of the data stream. Therefore, read repetitions are not necessary.

5.4 Other Quality Factors of the TIRIS Pulsed FM System

- High and consistent transponder product quality and performance by automated high volume manufacturing.
- The direct FSK provides enhanced separation and better position-selective reading of adjacent transponders compared to AM systems.
- Product migration path concept from RO to R/W to Password protected and Multipage transponders. The reader or system can be changed from RO to R/W by S/W change only.
- TIRIS transponders are 100% tested according to the procedures of TI's Total Quality Culture
- The reliability of TIRIS transponders is monitored through the following tests: temperature and humidity, thermal shock, and operating life.

6 EMI/EMC Performance

6.1 General

For any RFID system, the EMI/EMC performance is determined by three factors:

1. The reader design and the resulting noise immunity performance
2. The signal strength of the transponder and Signal/Noise ratio at the receiver input
3. The transponder immunity to EM fields:
 - The most critical EMI factor or component in a system is the reader immunity.
 - A high transponder data signal facilitates reader design through the higher Signal/Noise. ratio
 - The least critical component is the transponder. Immunity levels are generally very high.

All EMI sources can be classified into three different categories:

1. Broad band "industrial" noise of sporadic or continuous nature
2. Discrete radio frequency signals unmodulated or FM /FSK modulated
3. Discrete radio frequency signals which are AM or ASK modulated.

6.2 The Automotive Environment and Factors

In an automotive environment all noise types are present and potentially cause EMI problems.

Especially the increased application of electronics and communication systems in cars employing digital and ASK type modulation techniques can produce and emit high field strength levels.

The highest energy noise sources are in the low frequency part of the spectrum at frequencies from a few cycles up to a few kHz. The sources are actuators, solenoid switching, ignition, motors, control circuitry and so on. They pollute the car environment, either by direct emission, or by induction, or by conducted radiation.

Above 10 kHz, the noise levels decay quickly at a rate of 20 dB to 40 dB/octave. RFID systems emitting and receiving data signals at these or higher frequencies are less affected by EMI.

6.3 TIRIS Pulsed FM Transponder and System Performance

EMI measurement procedures which are most currently cited (for example, the DIN 40839/part4) are inappropriate to:

- Determine a realistic RFID system behavior for an automotive environment
- Determine the EMI performance and threshold of transponder
- Test systems at worst case (low frequency) conditions.

However, the TIRIS transponder meets and exceeds the DIN40839/part4.

The TIRIS system performance using reader and 23-mm transponder is shown in [Figure 11](#), [Figure 12](#) and [Figure 13](#).

[Figure 11](#) shows the system immunity over a spectrum of six decades. At the most critical Radio Short Wave Broadcast frequencies 400 V/m were encountered.

Figure 12 highlights the system performance simulating in-car RF communication conditions.

Figure 13 shows the performance (reading range) under induced broad band noise (white noise) conditions.

Pulsed FM EMI System Performance

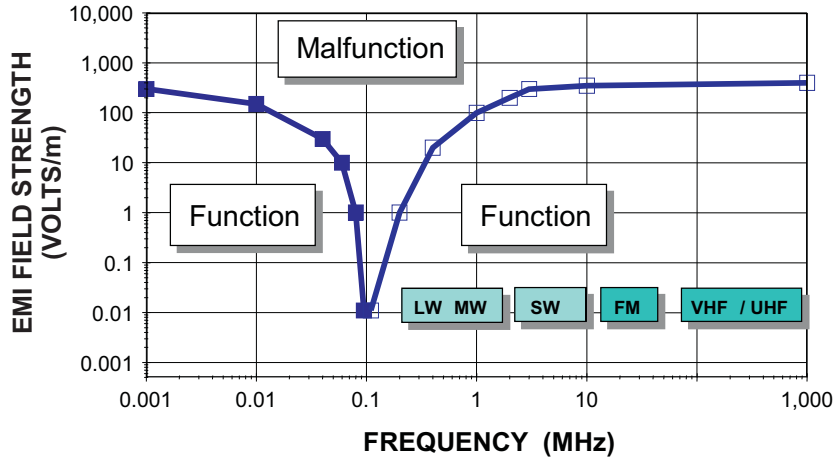

Figure 11. EMI Performance Test of the TIRIS System

The graph shows the EM Immunity level in V/m as function of the frequency range from 1 kHz to 1000 MHz. Measurement condition: minimum 90% read probability at maximum read range. Using a standard TIRIS reader.

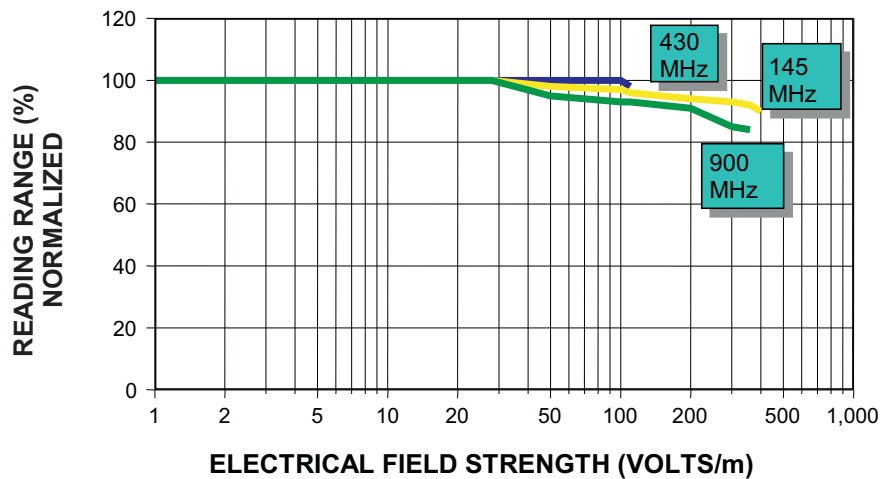

Figure 12. EMI Performance at Commonly Used Radio Communication Frequencies in Automotive Environment

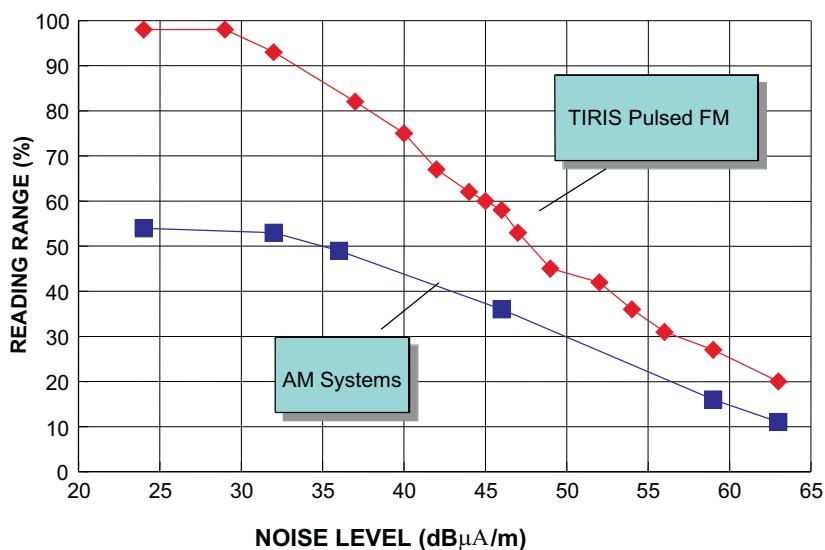

Figure 13. Reading Range Under Broadband Noise (White Noise) Conditions

7 Measurement Set-Ups

This section describes typical measurement set-ups to determine transponder relevant data like: resonant frequency, bandwidth, quality factor, powering field strength, and transponder signal field strength listed in Section 9 "Recommended Operating Conditions".

7.1 Measurement Set-Up: Resonance Frequency, Bandwidth, Quality Factor of Transponder

This test set-up is suitable for resonant frequency (f_{res}) measurements as well as the determination of the -3 -dB bandwidth (Δf) of the transponder. The quality factor Q of the transponder resonance circuit can be calculated with equation (1):

$$Q = \frac{f_{res}}{\Delta f} \quad (1)$$

The wires of the pick-up coil should be very thin to avoid influence on the measurement results (for example: by damping). The choice of a $1\text{ M}\Omega$ input resistor at the spectrum analyzer is recommended. [Figure 14](#) shows the test set-up. The relation between pick-up coil voltage and frequency is shown in [Figure 15](#).

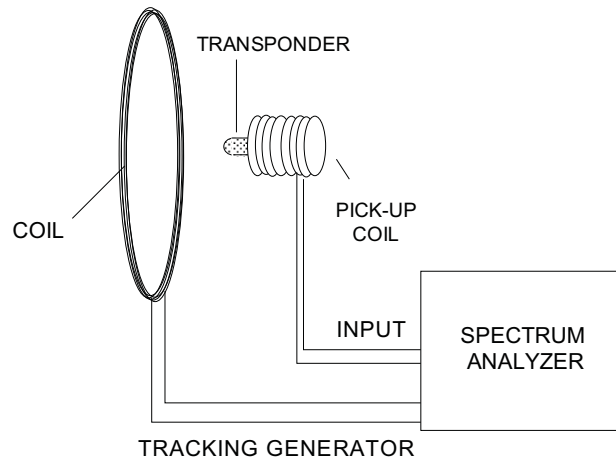

Figure 14. Measurement Set-up For the Determination of Transponder Resonance Frequency, Bandwidth, and Quality Factor

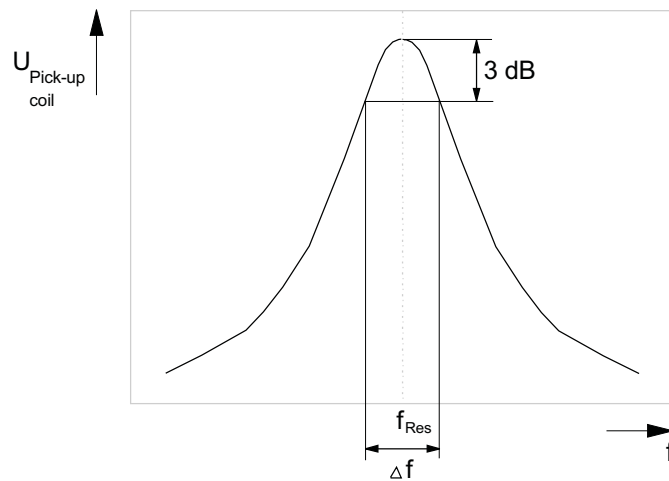

Figure 15. Determination of the Resonance Frequency and -3-dB Bandwidth by Monitoring the Pick-up Coil Voltage

7.2 Measurement Set-Up: Powering Field Strength

The following set-up is used to determine the minimum required powering field strength.

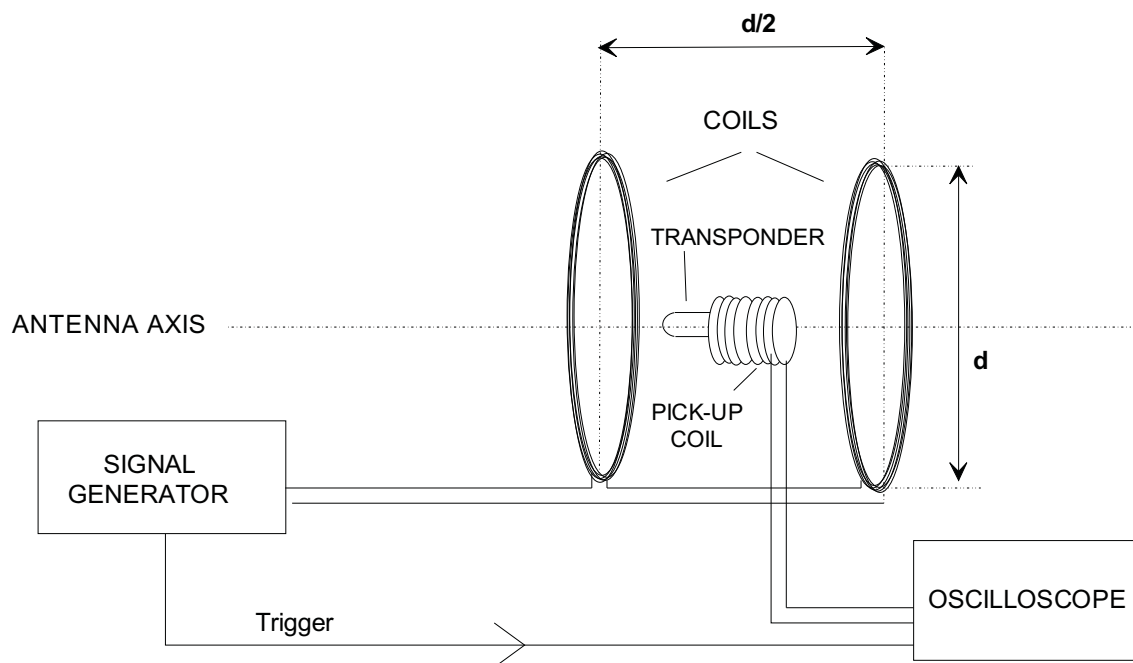

Figure 16. Test Set-Up For Powering Field Strength Determination

The field between both serial connected coils is homogeneous, due to the fact that the aperture is built according to the Helmholtz set-up. The circular coils are positioned in parallel on one axis. The distance between the coils is half the coil diameter. The transponder is positioned in the middle of the coil axis.

Determination of the minimum powering field strength is possible by changing the field strength through increasing the coil current. The relation between the generated magnetic flux/field strength and coil current can either be measured with a calibrated field probe, or calculated as follows:

$$B = \frac{4}{5} \cdot \sqrt{\frac{4}{5}} \cdot \frac{\mu_0 \cdot \mu_r \cdot N \cdot I}{d/2} = \mu_0 \cdot \mu_r \cdot H \quad (2)$$

- B: Magnetic flux (Tesla = Wb/m²)
- H: Magnetic field strength (A/m)
- N: Number of Helmholtz Coil windings
- d: Coil diameter (m)
- I: Coil current (A)
- μ_0 : Magnetic field constant (Vs/Am) = 4×10^{-7} Vs/Am
- μ_r : Relative magnetic field constant (in air: = 1)

The Helmholtz set-up can be used for the specification of transponders in the temperature range from -40°C to 85°C . Tests showed, however, that deviations of the field strength caused by temperature negligible.

The data telegram of the transponder can be captured by a pick-up coil (for example, 10 windings, thin wire to minimize influence) which wraps the transponder. The pulse modulated signal can be adjusted at the signal generator. The measurement of the power pulse and transponder diagram can be done with the help of an oscilloscope triggered by the generator signal (see [Figure 17](#)). As soon as a data telegram is completely detected the minimum necessary field strength (calculated with equation 2) can be monitored.

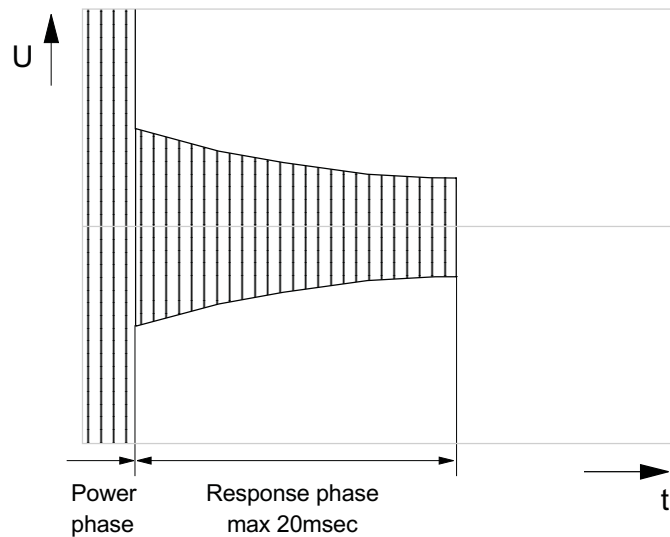

Figure 17. Received Signal at the Pickup Coil, If Power Field Strength Is Sufficient

7.3 Measurement Set-Up: Transponder Signal Strength

The 23-mm transponder has to be located into a homogeneous field (Helmholtz set-up). The pulsed power signal is generated by a signal generator. A calibrated field strength probe picks up the transponder signal. The field strength can be calculated by using the calibration factor of the field strength probe.

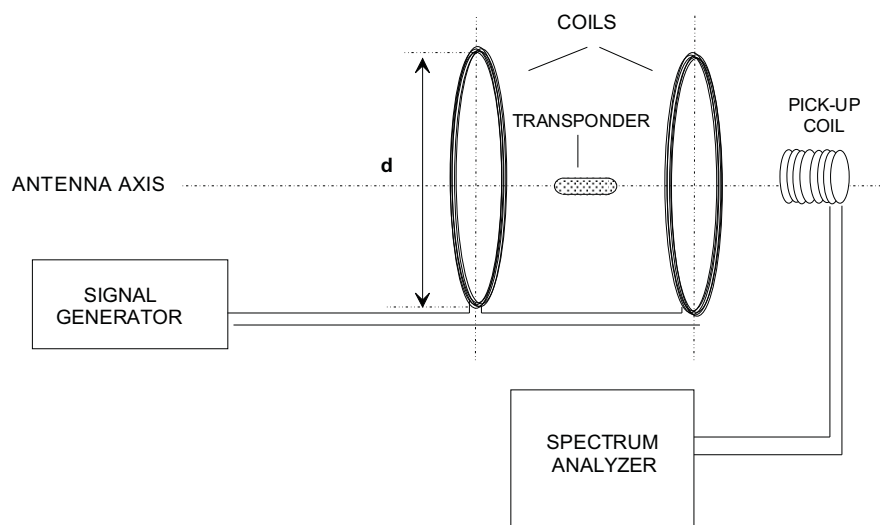

Figure 18. Determination of the Transponder Signal Strength (Data Transmission Signal Strength) With Helmholtz Aperture

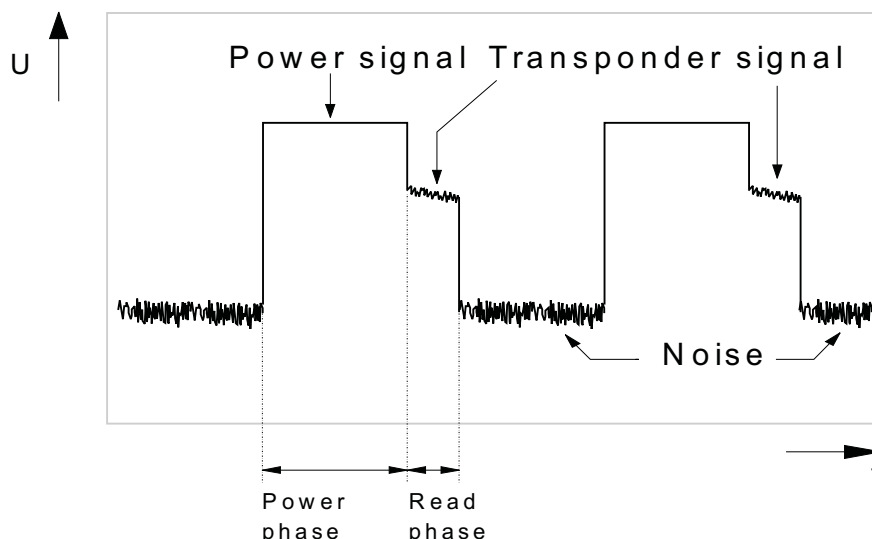

Figure 19. Monitored Signal Voltage at the Spectrum Analyzer (Time Domain Mode)

8 Absolute Maximum Ratings

All data given for free air operating temperature range (unless otherwise noted).

PARAMETER		CONDITION	MIN	NOM	MAX	UNIT
Operating temperature (read)	$T_{a_{read}}$		-40		85	°C
Operating temperature (program)	$T_{a_{prog}}$		-40		70	°C
Storage Temperature	T_s		-40		100	°C
Storage temperature	T_s	5 min			175	°C
Field Strength	H_{exc}	134.2 kHz			168	dB μ V/m

9 Recommended Operating Conditions

All data given for free air operating temperature range, a charge time of 50 ms, and a transmitter frequency of 134.2 kHz \pm 40 Hz (unless otherwise noted).

PARAMETER		CONDITION	MIN	NOM	MAX	UNIT
Charge duration for read and write	t_{exc}		15	50		ms
Charge frequency for read and write	f_{exc}		134.16	134.2	134.24	kHz
Programming Time	t_{prog}		15			ms
Programming field strength	H_{prog}	$t_{exc} = 50$ ms	142.5			dB μ A/m
Programming field strength	H_{prog}	25°C, $t_{exc} = 50$ ms	139.5			dB μ A/m
Activation field strength	H_{act}	$t_{exc} = 50$ ms	136.5			dB μ A/m
Activation field strength	H_{act}	25°C, $t_{exc} = 50$ ms	132.5			dB μ A/m
Write Bit Duration	t_{bit}	(1)		2		ms
Write pulse pause/low bit	t_{offL}	(1)		0.3		ms
Write pulse pause/high bit	t_{offH}	(1)		1		ms

(1) Depending on reader characteristics and environmental conditions.

10 Characteristics

All data given for free air temperature range, a charge time of 50 ms, and a transmitter frequency of 134.2 kHz \pm 40 Hz (unless otherwise noted).

PARAMETER		CONDITION	MIN	NOM	MAX	UNIT
Operating quality factor	Qop	(1)	62			
Low bit transmit frequency	f_L		131.5		139	kHz
Low bit transmit frequency	f_L	25°C	132.2	134.3	136.2	kHz
Low bit duration	t_L		0.115	0.119	0.121	ms
High bit transmit frequency	f_H		120		128	kHz
High bit transmit frequency	f_H	25°C	121	122.9	125	kHz
High bit duration	t_H		0.125	0.130	0.133	ms
Transponder output field strength at 5 cm	H_{out}		80		101	dB μ A/m
FSK modulation index (read); $f_L - f_H$	m_{read}	25°C	11			kHz
FSK modulation index (read); $f_L - f_H$	m_{read}	(2)	9		15	kHz
Data transmission rate (read)	r_{read}		7.4		8.7	kbit/s
Data transmission time (read)	r_{read}			16	20	ms
ASK modulation index (write)	m_{write}			100		%
Data transmission rate (write)	r_{write}	(3)		0.5		kbit/s
Data transmission time (write)	t_{write}	(3)		224		ms

(1) Specified Qop must be met in the application over the required temperature range. Refer to the test set-up shown in [Figure 14](#).

(2) Maintained over specified temperature range.

(3) Adaptable to application.

11 Environmental Data and Reliability

PARAMETER	CONDITION	MIN	NOM	MAX	UNIT
Programming cycles ⁽¹⁾	25°C	100 k			cycles
Data retention time ⁽¹⁾	100k cycles at 25°C storage temperature	10			years
EM radiation immunity	1 MHz to 512 MHz	100			V/m
EM radiation immunity	512 MHz to 1000 MHz	50			V/m
ESD immunity	IEC 801-2	2			kV
X-ray dose				2000	RAD
Vibration ⁽²⁾	IEC 68-2-6, Test Fc				
Shock	IEC 68-2-27, Test Ea				

(1) Cumulative failure rate 1%.

(2) $f = 10$ Hz – 2000 Hz.

12 Memory

PARAMETER	DATA
Memory size	80 bits
Memory organization	1 block
Identification data	64 bit
Error detection (Data BCC)	CRC – CCITT, 16 bit

13 Package

PARAMETER	DATA
Dimensions	23 mm × 3.85 mm (see Figure 3)
Weight	0.6 g

14 Packing Symbolization

The Transponders are packed in a carrier tape which is closed with a cover tape carrying product information and Country of Origin information as below:

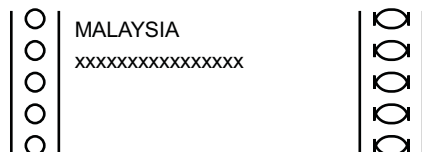

'XXXXXXXXXXXXXXXXXX' is the 16 digits Identification Code (ID) in hexadecimal numbers.

Appendix A Conversion Formula

Conversion formula between magnetic flux, magnetic field strength and electric field strength.

$$B = \mu_0 \cdot H$$

$$E = Z_f \cdot H$$

$$H = \left[\frac{E}{\text{dB}\mu\text{V} / \text{m}} - 51.5 \right] \frac{\text{dB}\mu\text{A}}{\text{m}}$$

;

$$[H] = \frac{\text{dB}\mu\text{A}}{\text{m}}$$

;

$$[E] = \frac{\text{dB}\mu\text{V}}{\text{m}}$$

B = Magnetic flux [Tesla = Wb/m² = Vs/m²]; 1 mWb/m² = 0.795 A/m

H = Magnetic field strength (A/m or in logarithmic term dBμA/m)

E = electrical field strength (V/m or in logarithmic term dBμV/m)

μ₀ = Magnetic field constant = 1.257 × 10⁻⁶ Vs/Am

Z_r = Free space impedance = 120 πΩ = 377 Ω

IMPORTANT NOTICE

Texas Instruments Incorporated and its subsidiaries (TI) reserve the right to make corrections, modifications, enhancements, improvements, and other changes to its products and services at any time and to discontinue any product or service without notice. Customers should obtain the latest relevant information before placing orders and should verify that such information is current and complete. All products are sold subject to TI's terms and conditions of sale supplied at the time of order acknowledgment.

TI warrants performance of its hardware products to the specifications applicable at the time of sale in accordance with TI's standard warranty. Testing and other quality control techniques are used to the extent TI deems necessary to support this warranty. Except where mandated by government requirements, testing of all parameters of each product is not necessarily performed.

TI assumes no liability for applications assistance or customer product design. Customers are responsible for their products and applications using TI components. To minimize the risks associated with customer products and applications, customers should provide adequate design and operating safeguards.

TI does not warrant or represent that any license, either express or implied, is granted under any TI patent right, copyright, mask work right, or other TI intellectual property right relating to any combination, machine, or process in which TI products or services are used. Information published by TI regarding third-party products or services does not constitute a license from TI to use such products or services or a warranty or endorsement thereof. Use of such information may require a license from a third party under the patents or other intellectual property of the third party, or a license from TI under the patents or other intellectual property of TI.

Reproduction of information in TI data books or data sheets is permissible only if reproduction is without alteration and is accompanied by all associated warranties, conditions, limitations, and notices. Reproduction of this information with alteration is an unfair and deceptive business practice. TI is not responsible or liable for such altered documentation.

Resale of TI products or services with statements different from or beyond the parameters stated by TI for that product or service voids all express and any implied warranties for the associated TI product or service and is an unfair and deceptive business practice. TI is not responsible or liable for any such statements.



Following are URLs where you can obtain information on other Texas Instruments products and application solutions:

Products		Applications	
Amplifiers	amplifier.ti.com	Audio	www.ti.com/audio
Data Converters	dataconverter.ti.com	Automotive	www.ti.com/automotive
DSP	dsp.ti.com	Broadband	www.ti.com/broadband
Interface	interface.ti.com	Digital Control	www.ti.com/digitalcontrol
Logic	logic.ti.com	Military	www.ti.com/military
Power Mgmt	power.ti.com	Optical Networking	www.ti.com/opticalnetwork
Microcontrollers	microcontroller.ti.com	Security	www.ti.com/security
Low Power Wireless	www.ti.com/lpw	Telephony	www.ti.com/telephony
		Video & Imaging	www.ti.com/video
		Wireless	www.ti.com/wireless

Mailing Address: Texas Instruments
Post Office Box 655303 Dallas, Texas 75265

Looking for pricing, stock, or lifecycle information?

Click below to explore more details on WIN SOURCE:

-  [View RI-TRP-RRHP-20](#) on WIN SOURCE
-  [Texas Instruments](#) Information

Optimize Your Supply Chain with WIN SOURCE Solutions

-  Global Sourcing Solution
-  Obsolete Management
-  Cost Control Management
-  Shortage Management
-  Alternative Solution
-  Excess Inventory Management