



# THE DATASHEET OF IRFPS30N60KPBF



## Power MOSFET

PRODUCT SUMMARY		
$V_{DS}$ (V)	600	
$R_{DS(on)}$ ( $\Omega$ )	$V_{GS} = 10$ V	0.16
$Q_g$ (Max.) (nC)	220	
$Q_{gs}$ (nC)	64	
$Q_{gd}$ (nC)	110	
Configuration	Single	

### FEATURES

- Low Gate Charge  $Q_g$  Results in Simple Drive Requirement
- Improved Gate, Avalanche and Dynamic  $dV/dt$  Ruggedness
- Fully Characterized Capacitance and Avalanche Voltage and Current
- Lead (Pb)-free Available



Available  
**RoHS\***  
COMPLIANT

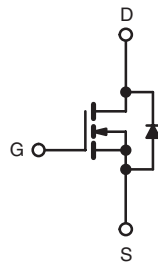
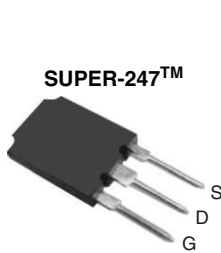

N-Channel MOSFET

### APPLICATIONS

- Switch Mode Power Supply (SMPS)
- Uninterruptible Power Supply
- High Speed Power Switching

ORDERING INFORMATION	
Package	Super-247™
Lead (Pb)-free	IRFPS30N60KPbF
	SiHFPS30N60K-E3
SnPb	IRFPS30N60K
	SiHFPS30N60K

ABSOLUTE MAXIMUM RATINGS $T_C = 25$ °C, unless otherwise noted					
PARAMETER		SYMBOL	LIMIT	UNIT	
Drain-Source Voltage		$V_{DS}$	600	V	
Gate-Source Voltage		$V_{GS}$	$\pm 30$		
Continuous Drain Current	$V_{GS}$ at 10 V	$I_D$	$T_C = 25$ °C	30	A
			$T_C = 100$ °C	19	
Pulsed Drain Current <sup>a</sup>		$I_{DM}$	120		
Linear Derating Factor			3.6	W/°C	
Single Pulse Avalanche Energy <sup>b</sup>		$E_{AS}$	520	mJ	
Repetitive Avalanche Current <sup>a</sup>		$I_{AR}$	30	A	
Repetitive Avalanche Energy <sup>a</sup>		$E_{AR}$	45	mJ	
Maximum Power Dissipation	$T_C = 25$ °C	$P_D$	450	W	
Peak Diode Recovery $dV/dt^c$		$dV/dt$	13	V/ns	
Operating Junction and Storage Temperature Range		$T_J, T_{stg}$	- 55 to + 150	°C	
Soldering Recommendations (Peak Temperature)	for 10 s		300 <sup>d</sup>		

### Notes

- Repetitive rating; pulse width limited by maximum junction temperature.
- Starting  $T_J = 25$  °C,  $L = 1.1$  mH,  $R_G = 25$   $\Omega$ ,  $I_{AS} = 30$  A.
- $I_{SD} \leq 30$  A,  $dI/dt \leq 630$  A/ $\mu$ s,  $V_{DD} \leq V_{DS}$ ,  $T_J \leq 150$  °C.
- 1.6 mm from case.

\* Pb containing terminations are not RoHS compliant, exemptions may apply

THERMAL RESISTANCE RATINGS				
PARAMETER	SYMBOL	TYP.	MAX.	UNIT
Maximum Junction-to-Ambient <sup>a</sup>	$R_{thJA}$	-	40	°C/W
Case-to-Sink, Flat, Greased Surface	$R_{thCS}$	0.24	-	
Maximum Junction-to-Case (Drain) <sup>a</sup>	$R_{thJC}$	-	0.28	

### Note

a.  $R_{th}$  is measured at  $T_J$  approximately 90 °C.

SPECIFICATIONS $T_J = 25\text{ °C}$ , unless otherwise noted						
PARAMETER	SYMBOL	TEST CONDITIONS	MIN.	TYP.	MAX.	UNIT
<b>Static</b>						
Drain-Source Breakdown Voltage	$V_{DS}$	$V_{GS} = 0\text{ V}, I_D = 250\text{ }\mu\text{A}$	600	-	-	V
$V_{DS}$ Temperature Coefficient	$\Delta V_{DS}/T_J$	Reference to 25 °C, $I_D = 1\text{ mA}^d$	-	0.66	-	V/°C
Gate-Source Threshold Voltage	$V_{GS(th)}$	$V_{DS} = V_{GS}, I_D = 250\text{ }\mu\text{A}$	3.0	-	5.0	V
Gate-Source Leakage	$I_{GSS}$	$V_{GS} = \pm 30\text{ V}$	-	-	$\pm 100$	nA
Zero Gate Voltage Drain Current	$I_{DSS}$	$V_{DS} = 600\text{ V}, V_{GS} = 0\text{ V}$	-	-	50	$\mu\text{A}$
		$V_{DS} = 480\text{ V}, V_{GS} = 0\text{ V}, T_J = 125\text{ °C}$	-	-	250	
Drain-Source On-State Resistance	$R_{DS(on)}$	$V_{GS} = 10\text{ V}, I_D = 18\text{ A}^b$	-	0.16	0.19	$\Omega$
Forward Transconductance	$g_{fs}$	$V_{DS} = 50\text{ V}, I_D = 18\text{ A}$	16	-	-	S
<b>Dynamic</b>						
Input Capacitance	$C_{iss}$	$V_{GS} = 0\text{ V}, V_{DS} = 25\text{ V}, f = 1.0\text{ MHz}$	-	5870	-	pF
Output Capacitance	$C_{oss}$		-	530	-	
Reverse Transfer Capacitance	$C_{rss}$		-	54	-	
Output Capacitance	$C_{oss}$	$V_{GS} = 0\text{ V}$	$V_{DS} = 1.0\text{ V}, f = 1.0\text{ MHz}$	-	6920	-
Effective Output Capacitance	$C_{oss\text{ eff.}}$		$V_{DS} = 480\text{ V}, f = 1.0\text{ MHz}$	-	140	-
Total Gate Charge	$Q_g$	$V_{GS} = 10\text{ V}, I_D = 30\text{ A}, V_{DS} = 480\text{ V}^b$	$V_{DS} = 0\text{ V to } 480\text{ V}^c$	-	270	-
Gate-Source Charge	$Q_{GS}$		-	-	220	nC
Gate-Drain Charge	$Q_{GD}$		-	-	64	
Turn-On Delay Time	$t_{d(on)}$	$V_{DD} = 300\text{ V}, I_D = 30\text{ A}, R_G = 3.9\text{ }\Omega, V_{GS} = 10\text{ V}^b$	-	29	-	
Rise Time	$t_r$		-	120	-	
Turn-Off Delay Time	$t_{d(off)}$		-	56	-	
Fall Time	$t_f$		-	50	-	
<b>Drain-Source Body Diode Characteristics</b>						
Continuous Source-Drain Diode Current	$I_S$	MOSFET symbol showing the integral reverse p - n junction diode 	-	-	30	A
Pulsed Diode Forward Current <sup>a</sup>	$I_{SM}$		-	-	120	
Body Diode Voltage	$V_{SD}$	$T_J = 25\text{ °C}, I_S = 30\text{ A}, V_{GS} = 0\text{ V}^b$	-	-	1.5	V
Body Diode Reverse Recovery Time	$t_{rr}$	$T_J = 25\text{ °C}, I_F = 30\text{ A}, di/dt = 100\text{ A}/\mu\text{s}^b$	-	640	960	ns
Body Diode Reverse Recovery Charge	$Q_{rr}$		-	11	16	$\mu\text{C}$
Body Diode Recovery Current	$I_{RRM}$		-	31	-	A
Forward Turn-On Time	$t_{on}$	Intrinsic turn-on time is negligible (turn-on is dominated by $L_S$ and $L_D$ )				

### Notes

- Repetitive rating; pulse width limited by maximum junction temperature (see fig. 11).
- Pulse width  $\leq 300\text{ }\mu\text{s}$ ; duty cycle  $\leq 2\%$ .
- $C_{oss\text{ eff.}}$  is a fixed capacitance that gives the same charging time as  $C_{oss}$  while  $V_{DS}$  is rising from 0 to 80 %  $V_{DS}$ .

**TYPICAL CHARACTERISTICS** 25 °C, unless otherwise noted

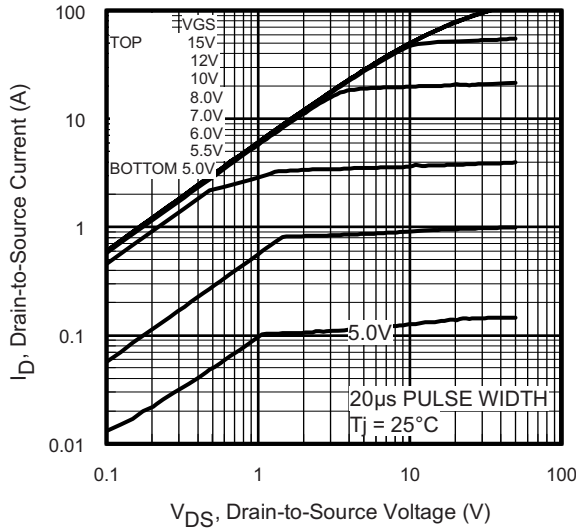

**Fig. 1 - Typical Output Characteristics**

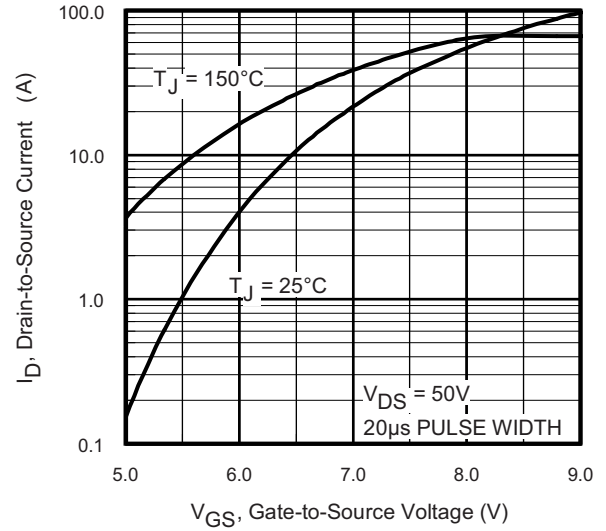

**Fig. 3 - Typical Transfer Characteristics**

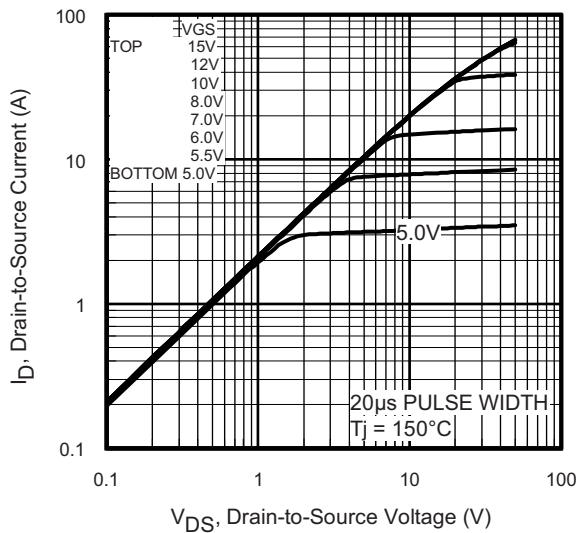

**Fig. 2 - Typical Output Characteristics**

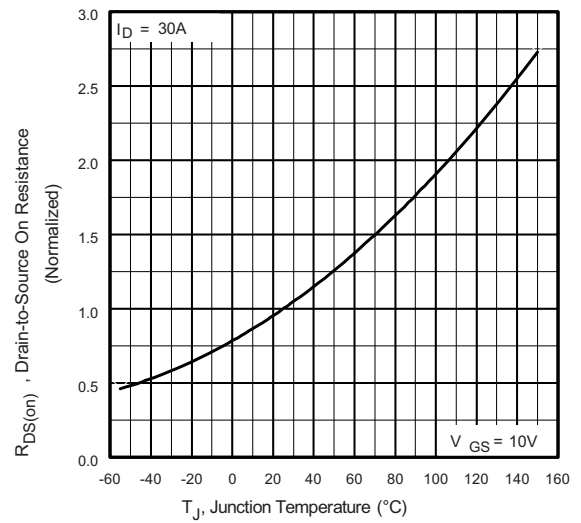

**Fig. 4 - Normalized On-Resistance vs. Temperature**

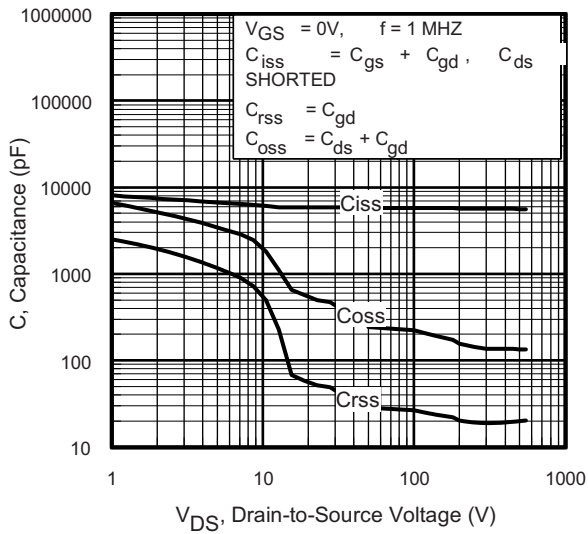

Fig. 5 - Typical Capacitance vs. Drain-to-Source Voltage

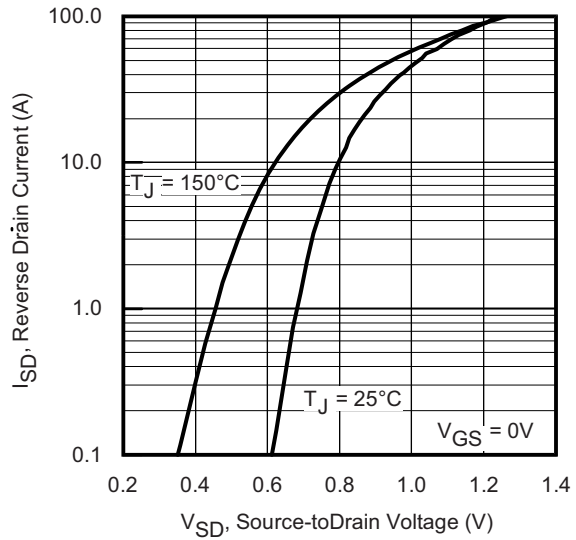

Fig. 7 - Typical Source-Drain Diode Forward Voltage

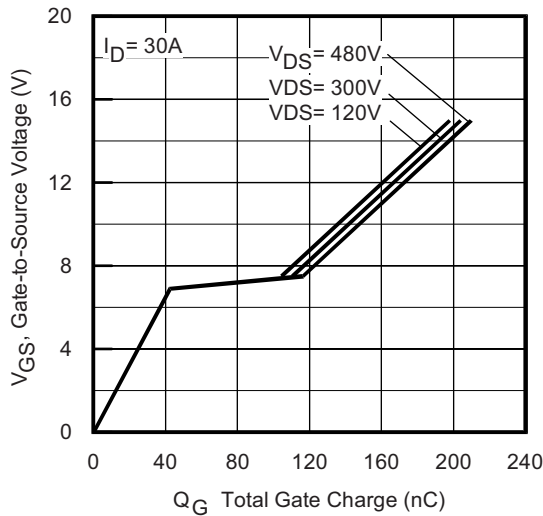

Fig. 6 - Typical Gate Charge vs. Gate-to-Source Voltage

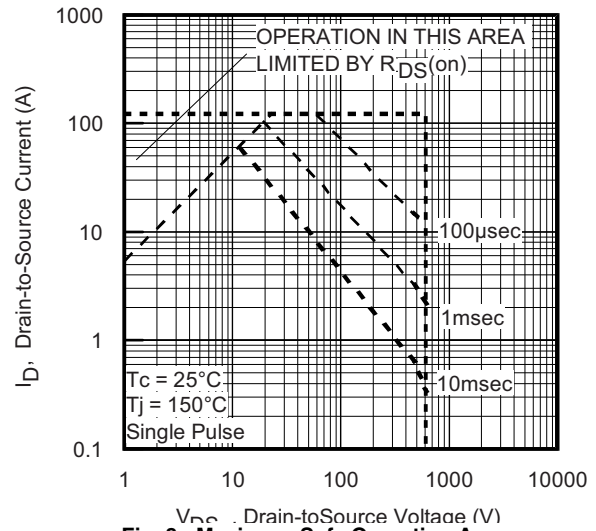
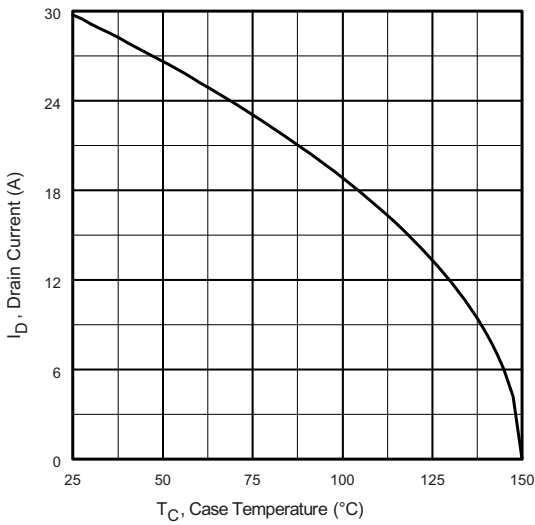
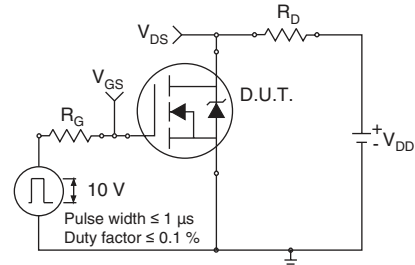

Fig. 8 - Maximum Safe Operating Area



**Fig. 9 - Maximum Drain Current vs. Case Temperature**



**Fig. 10a - Switching Time Test Circuit**

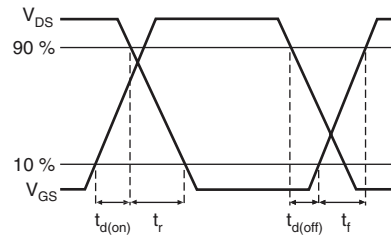

**Fig. 10b - Switching Time Waveforms**

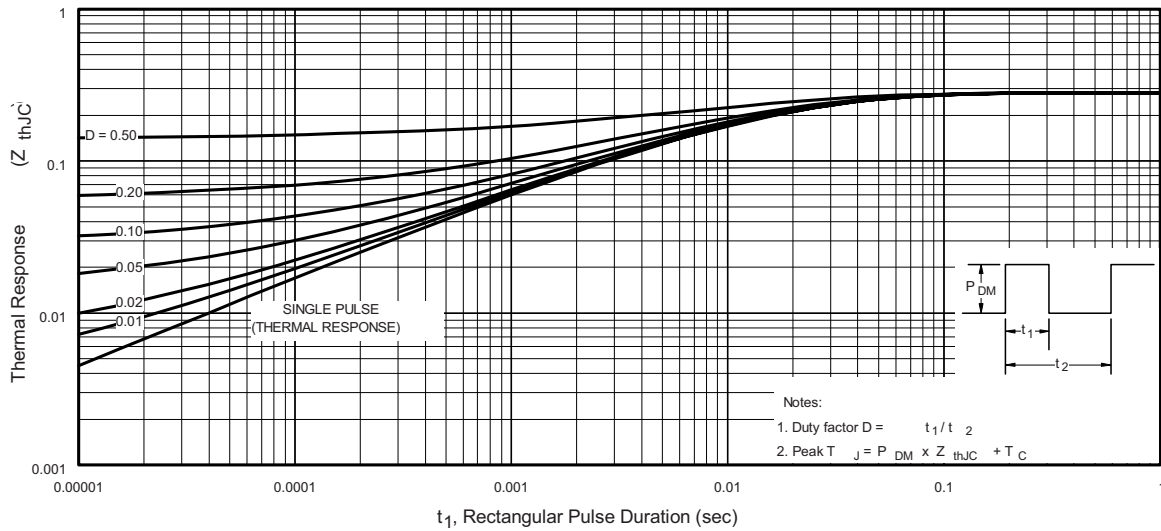

**Fig. 11 - Maximum Effective Transient Thermal Impedance, Junction-to-Case**

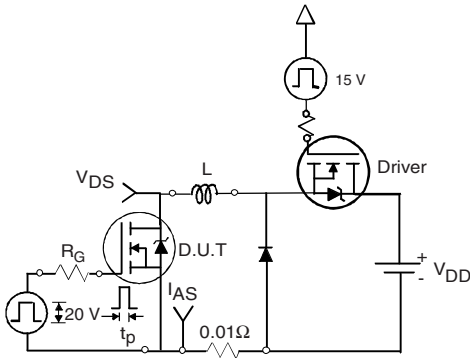

Fig. 12a - Unclamped Inductive Test Circuit

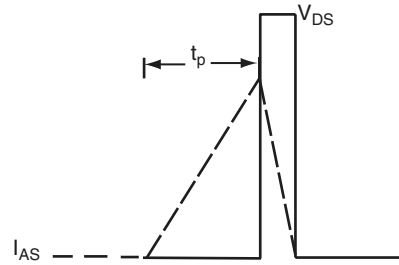

Fig. 12b - Unclamped Inductive Waveforms

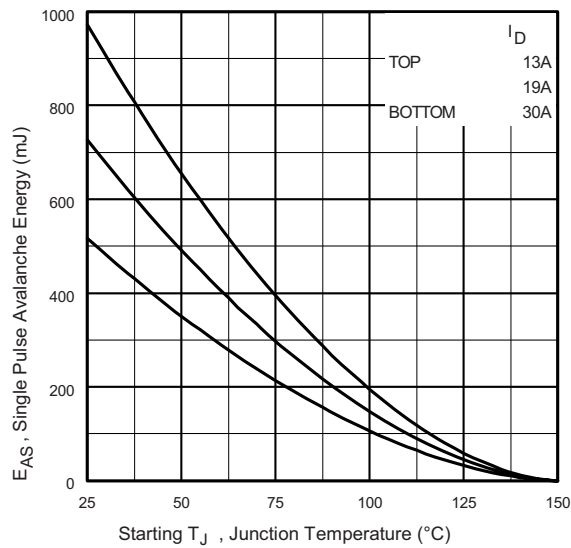

Fig. 12c - Maximum Avalanche Energy vs. Drain Current

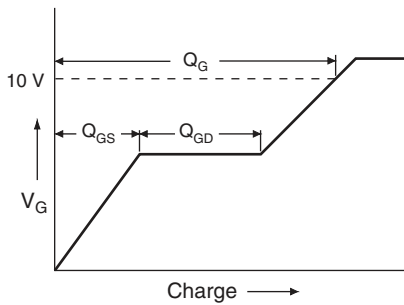

Fig. 13a - Basic Gate Charge Waveform

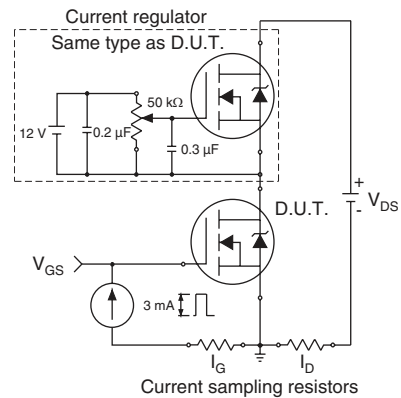

Fig. 13b - Gate Charge Test Circuit

## Peak Diode Recovery $dV/dt$ Test Circuit

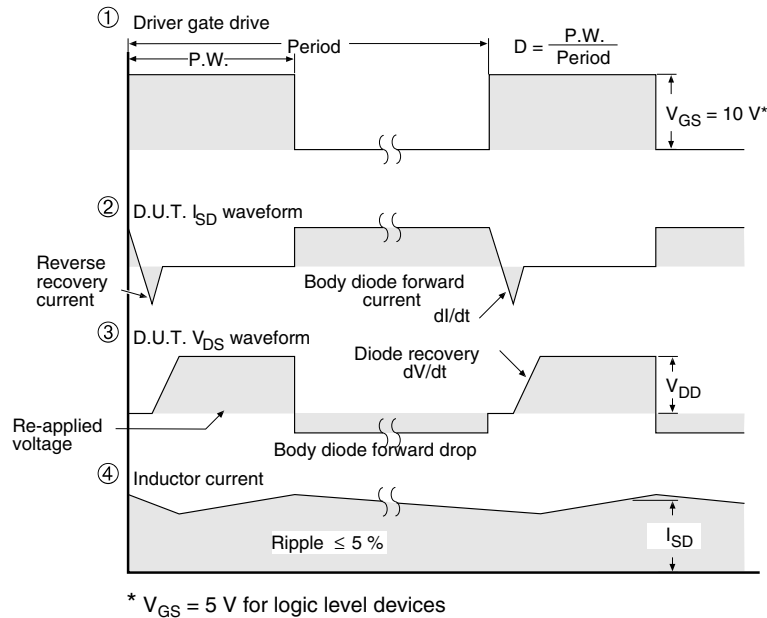
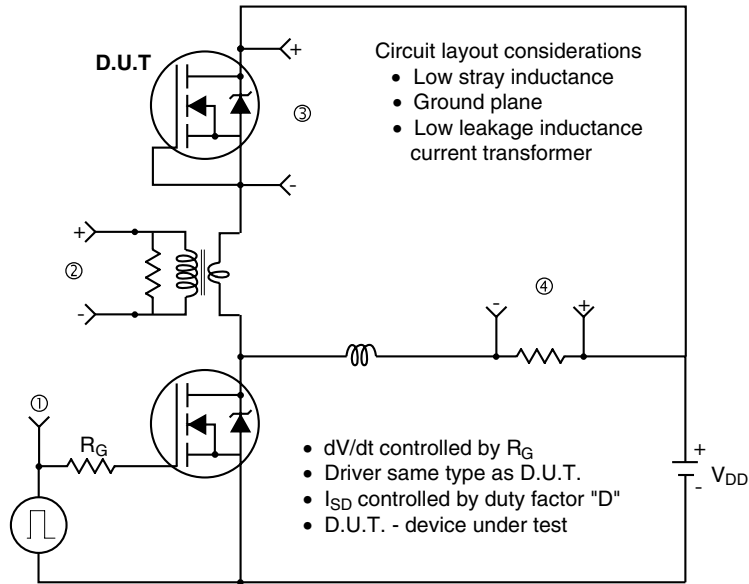

Fig. 14 - For N-Channel

Vishay Siliconix maintains worldwide manufacturing capability. Products may be manufactured at one of several qualified locations. Reliability data for Silicon Technology and Package Reliability represent a composite of all qualified locations. For related documents such as package/tape drawings, part marking, and reliability data, see [www.vishay.com/ppg?91256](http://www.vishay.com/ppg?91256).



## Disclaimer

All product specifications and data are subject to change without notice.

Vishay Intertechnology, Inc., its affiliates, agents, and employees, and all persons acting on its or their behalf (collectively, "Vishay"), disclaim any and all liability for any errors, inaccuracies or incompleteness contained herein or in any other disclosure relating to any product.

Vishay disclaims any and all liability arising out of the use or application of any product described herein or of any information provided herein to the maximum extent permitted by law. The product specifications do not expand or otherwise modify Vishay's terms and conditions of purchase, including but not limited to the warranty expressed therein, which apply to these products.

No license, express or implied, by estoppel or otherwise, to any intellectual property rights is granted by this document or by any conduct of Vishay.

The products shown herein are not designed for use in medical, life-saving, or life-sustaining applications unless otherwise expressly indicated. Customers using or selling Vishay products not expressly indicated for use in such applications do so entirely at their own risk and agree to fully indemnify Vishay for any damages arising or resulting from such use or sale. Please contact authorized Vishay personnel to obtain written terms and conditions regarding products designed for such applications.

Product names and markings noted herein may be trademarks of their respective owners.

## Looking for pricing, stock, or lifecycle information?

Click below to explore more details on WIN SOURCE:

 [View IRFPS30N60KPBF on WIN SOURCE](#)

 [Vishay Information](#)

## Optimize Your Supply Chain with WIN SOURCE Solutions

-  Global Sourcing Solution
-  Obsolete Management
-  Cost Control Management
-  Shortage Management
-  Alternative Solution
-  Excess Inventory Management