



**THE DATASHEET OF
74AUP1G07FS3-7**



Description

The Advanced, Ultra Low Power (AUP) CMOS logic family is designed for low power and extended battery life in portable applications.

The 74AUP1G07 is a single buffer-gate, with an open drain output designed for operation over a power supply range of 0.8V to 3.6V.

The device is fully specified for partial power down applications using I_{OFF}. The I_{OFF} circuitry disables the output preventing damaging current backflow when the device is powered down. The gate performs the positive Boolean function:

$$Y = A$$

Features

- Advanced Ultra Low Power (AUP) CMOS
- Supply Voltage Range from 0.8V to 3.6V
- 4 mA Output Drive at 3.0V
- Low Static Power Consumption
I_{CC} < 0.9µA
- Low Dynamic Power Consumption
C_{PD} = 6pF (Typical at 3.6V)
- Schmitt Trigger Action at all inputs makes the circuit tolerant for slower input rise and fall time. The hysteresis is typically 250 mV at V_{CC} = 3.0V.
- I_{OFF} Supports Partial-Power-Down Mode Operation
- ESD Protection Exceeds JESD 22
2000-V Human Body Model (A114)
Exceeds 1000-V Charged Device Model (C101)
- Latch-Up Exceeds 100mA per JESD 78, Class I
- Leadless Packages Named per JESD30E
- **Totally Lead-Free & Fully RoHS Compliant (Notes 1 & 2)**
- **Halogen and Antimony Free. "Green" Device (Note 3)**

- Notes:
1. No purposely added lead. Fully EU Directive 2002/95/EC (RoHS) & 2011/65/EU (RoHS 2) compliant.
 2. See http://www.diodes.com/quality/lead_free.html for more information about Diodes Incorporated's definitions of Halogen- and Antimony-free "Green" and Lead-free.
 3. Halogen- and Antimony-free "Green" products are defined as those which contain <900ppm bromine, <900ppm chlorine (<1500ppm total Br + Cl) and <1000ppm antimony compounds.

Pin Assignments

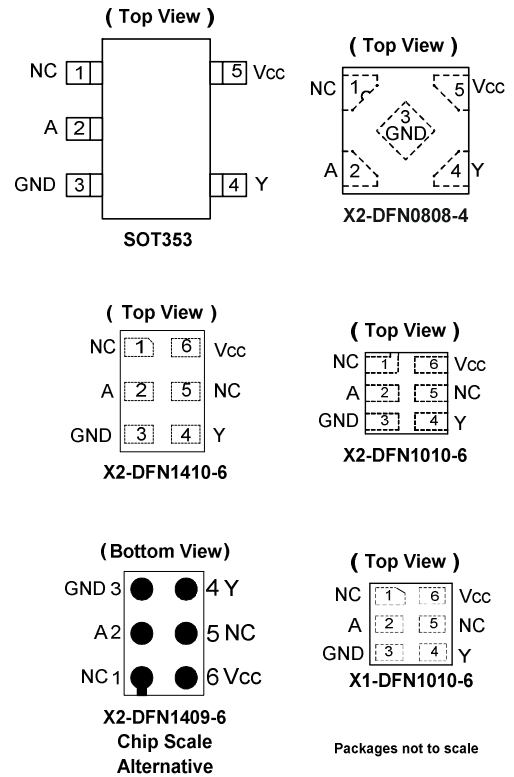

Applications

- Suited for Battery and Low Power Needs
- Wide array of products such as:
 - Tablets, E-readers
 - Cell Phones, Personal Navigation / GPS
 - MP3 Players, Cameras, Video Recorders
 - PCs, Ultrabooks, Notebooks, Netbooks
 - Computer Peripherals, Hard Drives, SSDs, CD/DVD ROMs
 - TVs, DVDs, DVRs, Set-Top Boxes

Ordering Information

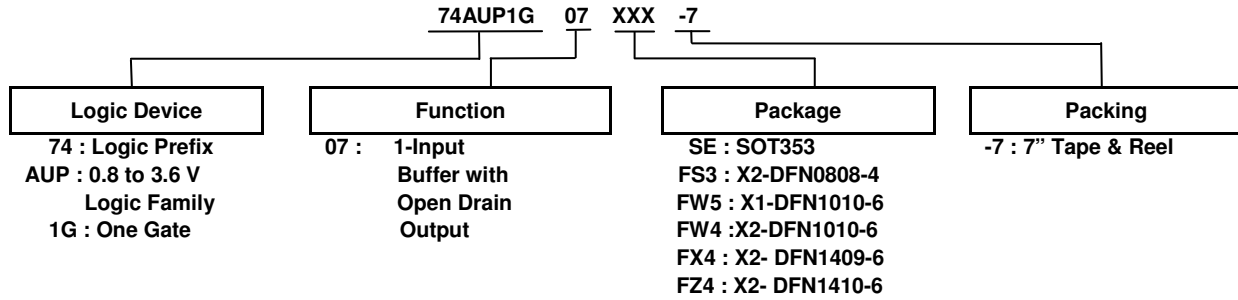

| Device | Package Code | Package (Notes 4 & 5) | Package Size | 7" Tape and Reel | |
|----------------|--------------|--|---|-------------------|--------------------|
| | | | | Quantity | Part Number Suffix |
| 74AUP1G07SE-7 | SE | SOT353 | 2.0mm x 2.0mm x 1.1mm 0.65 mm lead pitch | 3,000/Tape & Reel | -7 |
| 74AUP1G07FS3-7 | FS3 | X2-DFN0808-4 | 0.8mm x 0.8 mm x 0.35mm 0.5 mm pad pitch (diamond) | 5,000/Tape & Reel | -7 |
| 74AUP1G07FW5-7 | FW5 | X1-DFN1010-6 | 1.0mm x 1.0mm x 0.5mm 0.35 mm pad pitch | 5,000/Tape & Reel | -7 |
| 74AUP1G07FW4-7 | FW4 | X2-DFN1010-6 | 1.0mm x 1.0mm x 0.4mm 0.35 mm pad pitch | 5,000/Tape & Reel | -7 |
| 74AUP1G07FX4-7 | FX4 | X2-DFN1409-6 Chip Scale Alternative | 1.4mm x 0.9mm x 0.4mm 0.5 mm pad pitch | 5,000/Tape & Reel | -7 |
| 74AUP1G07FZ4-7 | FZ4 | X2-DFN1410-6 | 1.4mm x 1.0mm x 0.4mm 0.5 mm pad pitch | 5,000/Tape & Reel | -7 |

Notes: 4. Pad layout as shown on Diodes Inc. suggested pad layout document AP02001, which can be found on our website at <http://www.diodes.com/datasheets/ap02001.pdf>.
 5. The taping orientation is located on our website at <http://www.diodes.com/datasheets/ap02007.pdf>.

Pin Descriptions

| Pin Name | Function |
|-----------------|----------------|
| NC | No Connection |
| A | Data Input |
| GND | Ground |
| Y | Data Output |
| V _{CC} | Supply Voltage |

Logic Diagram

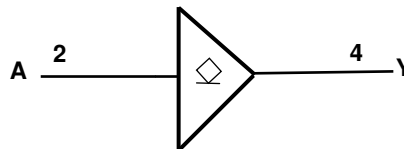

Function Table

| Inputs | Output |
|--------|--------|
| A | Y |
| H | Z |
| L | L |

Absolute Maximum Ratings (Notes 6 & 7) (@ $T_A = +25^\circ\text{C}$, unless otherwise specified.)

| Symbol | Parameter | Rating | Unit |
|-----------|---|--------------|------------------|
| ESD HBM | Human Body Model ESD Protection | 2 | kV |
| ESD CDM | Charged Device Model ESD Protection | 1 | kV |
| V_{CC} | Supply Voltage Range | -0.5 to +4.6 | V |
| V_I | Input Voltage Range | -0.5 to +4.6 | V |
| V_O | Voltage Applied to Output in High or Low State | -0.5 to +4.6 | V |
| I_{IK} | Input Clamp Current $V_I < 0$ | 50 | mA |
| I_{OK} | Output Clamp Current ($V_O < 0$) | 50 | mA |
| I_O | Continuous Output Current ($V_O = 0$ to V_{CC}) | ± 20 | mA |
| I_{CC} | Continuous Current through V_{CC} | 50 | mA |
| I_{GND} | Continuous Current through GND | -50 | mA |
| T_J | Operating Junction Temperature | -40 to +150 | $^\circ\text{C}$ |
| T_{STG} | Storage Temperature | -65 to +150 | $^\circ\text{C}$ |

- Notes:
- Stresses beyond the absolute maximum may result in immediate failure or reduced reliability. These are stress values and device operation should be within recommend values.
 - Forcing the maximum allowed voltage could cause a condition exceeding the maximum current or conversely forcing the maximum current could cause a condition exceeding the maximum voltage. The ratings of both current and voltage must be maintained within the controlled range.

Recommended Operating Conditions (Note 8) (@ $T_A = +25^\circ\text{C}$, unless otherwise specified.)

| Symbol | Parameter | Min | Max | Unit | |
|---------------------|------------------------------------|---|------|------------------|---------------|
| V_{CC} | Operating Voltage | 0.8 | 3.6 | V | |
| V_I | Input Voltage | 0 | 3.6 | V | |
| V_O | Output Voltage | 0 | 3.6 | V | |
| I_{OL} | Low-Level Output Current | $V_{CC} = 0.8\text{V}$ | — | 20 | μA |
| | | $V_{CC} = 1.1\text{V}$ | — | 1.1 | mA |
| | | $V_{CC} = 1.4\text{V}$ | — | 1.7 | |
| | | $V_{CC} = 1.65\text{V}$ | — | 1.9 | |
| | | $V_{CC} = 2.3\text{V}$ | — | 3.1 | |
| | | $V_{CC} = 3.0\text{V}$ | — | 4 | |
| $\Delta t/\Delta V$ | Input Transition Rise or Fall Rate | $V_{CC} = 0.8\text{V}$ to 3.6V | — | 200 | ns/V |
| T_A | Operating Free-Air Temperature | -40 | +125 | $^\circ\text{C}$ | |

- Note: 8. Unused inputs should be held at V_{CC} or Ground.

Electrical Characteristics (@ $T_A = +25^\circ\text{C}$, unless otherwise specified.)

| Symbol | Parameter | Test Conditions | V_{CC} | $T_A = +25^\circ\text{C}$ | | $T_A = -40^\circ\text{C to } +85^\circ\text{C}$ | | Unit |
|------------------|----------------------------------|--|----------------|---------------------------|----------------------|---|----------------------|---------------|
| | | | | Min | Max | Min | Max | |
| V_{IH} | High-Level Input Voltage | — | 0.8V to 1.65V | $0.80 \times V_{CC}$ | — | $0.80 \times V_{CC}$ | — | V |
| | | — | 1.65V to 1.95V | $0.65 \times V_{CC}$ | — | $0.65 \times V_{CC}$ | — | |
| | | — | 2.3V to 2.7V | 1.6 | — | 1.6 | — | |
| | | — | 3.0V to 3.6V | 2.0 | — | 2.0 | — | |
| V_{IL} | Low-Level Input Voltage | — | 0.8V to 1.65V | — | $0.30 \times V_{CC}$ | — | $0.30 \times V_{CC}$ | V |
| | | — | 1.65V to 1.95V | — | $0.35 \times V_{CC}$ | — | $0.35 \times V_{CC}$ | |
| | | — | 2.3V to 2.7V | — | 0.7 | — | 0.7 | |
| | | — | 3.0V to 3.6V | — | 0.9 | — | 0.9 | |
| V_{OL} | Low-Level Output Voltage | $I_{OL} = 20\mu\text{A}$ | 0.8V to 3.6V | — | 0.1 | — | 0.1 | V |
| | | $I_{OL} = 1.1\text{mA}$ | 1.1V | — | $0.3 \times V_{CC}$ | — | $0.3 \times V_{CC}$ | |
| | | $I_{OL} = 1.7\text{mA}$ | 1.4V | — | 0.31 | — | 0.37 | |
| | | $I_{OL} = 1.9\text{mA}$ | 1.65V | — | 0.31 | — | 0.35 | |
| | | $I_{OL} = 2.3\text{mA}$ | 2.3V | — | 0.31 | — | 0.33 | |
| | | $I_{OL} = 3.1\text{mA}$ | | — | 0.44 | — | 0.45 | |
| | | $I_{OL} = 2.7\text{mA}$ | 3V | — | 0.31 | — | 0.33 | |
| | | $I_{OL} = 4\text{mA}$ | | — | 0.44 | — | 0.45 | |
| I_I | Input Current | A or B Input $V_i = \text{GND to } 3.6\text{V}$ | 0V to 3.6V | — | ± 0.1 | — | ± 0.5 | μA |
| I_{OFF} | Power Down Leakage Current | V_i or $V_o = 0\text{V to } 3.6\text{V}$ | 0 | — | ± 0.2 | — | ± 0.5 | μA |
| I_{OZ} | Z State Leakage Current | $V_o = 3.6\text{V}$ $V_i = 3.6\text{V}$ | 3.6V | — | ± 0.2 | — | ± 0.5 | μA |
| ΔI_{OFF} | Delta Power Down Leakage Current | V_i or $V_o = 0\text{V to } 3.6\text{V}$ | 0V to 0.2V | — | 0.2 | — | 0.6 | μA |
| I_{CC} | Supply Current | $V_i = \text{GND or } V_{CC}, I_o = 0$ | 0.8V to 3.6V | — | 0.5 | — | 0.9 | μA |
| ΔI_{CC} | Additional Supply Current | Input at $V_{CC} - 0.6\text{V}$ | 3.3V | — | 40 | — | 50 | μA |

Electrical Characteristics (continued) (@T_A = +25°C, unless otherwise specified.)

| Symbol | Parameter | Test Conditions | V _{CC} | T _A = -40°C to +125°C | | Unit |
|-------------------|----------------------------------|--|-----------------|----------------------------------|------------------------|------|
| | | | | Min | Max | |
| V _{IH} | High-Level Input Voltage | — | 0.8V to 1.65V | 0.80 x V _{CC} | — | V |
| | | — | 1.65V to 1.95V | 0.70 x V _{CC} | — | |
| | | — | 2.3V to 2.7V | 1.6 | — | |
| | | — | 3.0V to 3.6V | 2.0 | — | |
| V _{IL} | Low-Level Input Voltage | — | 0.8V to 1.65V | — | 0.25 x V _{CC} | V |
| | | — | 1.65V to 1.95V | — | 0.35 x V _{CC} | |
| | | — | 2.3V to 2.7V | — | 0.7 | |
| | | — | 3.0V to 3.6V | — | 0.9 | |
| V _{OL} | Low-Level Output Voltage | I _{OL} = 20μA | 0.8V to 3.6V | — | 0.11 | V |
| | | I _{OL} = 1.1mA | 1.1V | — | 0.3 x V _{CC} | |
| | | I _{OL} = 1.7mA | 1.4V | — | 0.41 | |
| | | I _{OL} = 1.9mA | 1.65V | — | 0.39 | |
| | | I _{OL} = 2.3mA | 2.3V | — | 0.36 | |
| | | I _{OL} = 3.1mA | | — | 0.50 | |
| | | I _{OL} = 2.7mA | 3V | — | 0.36 | |
| | | I _{OL} = 4mA | | — | 0.50 | |
| I _I | Input Current | A or B Input V _I = GND to 3.6V | 0V to 3.6V | — | ± 0.75 | μA |
| I _{OFF} | Power Down Leakage Current | V _I or V _O = 0V to 3.6V | 0 | — | ± 3.5 | μA |
| I _{OZ} | Z State Leakage Current | V _O = 3.6V V _I = 3.6V | 3.6V | — | ± 1.5 | μA |
| ΔI _{OFF} | Delta Power Down Leakage Current | V _I or V _O = 0V to 3.6V | 0V to 0.2V | — | ± 2.5 | μA |
| I _{CC} | Supply Current | V _I = GND or V _{CC} , I _O = 0 | 0.8V to 3.6V | — | 3.0 | μA |
| ΔI _{CC} | Additional Supply Current | Input at V _{CC} -0.6V | 3.3V | — | 75 | μA |

Switching Characteristics

 $C_L = 5\text{pF}$, See Figure 1

| Parameter | From Input | TO OUTPUT | V _{cc} | T _A = +25°C | | | T _A = -40°C to +85°C | | T _A = -40°C to +125°C | | Unit |
|-----------------|------------|-----------|-----------------|------------------------|------|-----|---------------------------------|-----|----------------------------------|------|------|
| | | | | Min | Typ | Max | Min | Max | Min | Max | |
| t _{pd} | A | Y | 0.8V | — | 11.6 | — | — | — | — | — | ns |
| | | | 1.2V ± 0.1V | 2.0 | 4.1 | 7.5 | 2.0 | 9.1 | 2.0 | 10.0 | |
| | | | 1.5V ± 0.1V | 1.5 | 3.0 | 5.1 | 1.5 | 6.1 | 1.5 | 6.7 | |
| | | | 1.8V ± 0.15V | 1.2 | 2.7 | 4.0 | 1.2 | 5.0 | 1.2 | 5.5 | |
| | | | 2.5V ± 0.2V | 1.0 | 2.3 | 3.2 | 1.0 | 4.0 | 1.0 | 4.4 | |
| | | | 3.3V ± 0.3V | 0.8 | 2.2 | 2.8 | 0.8 | 3.3 | 0.8 | 3.6 | |

 $C_L = 10\text{pF}$, See Figure 1

| Parameter | From Input | TO OUTPUT | V _{cc} | T _A = +25°C | | | T _A = -40°C to +85°C | | T _A = -40°C to +125°C | | Unit |
|-----------------|------------|-----------|-----------------|------------------------|------|-----|---------------------------------|------|----------------------------------|------|------|
| | | | | Min | Typ | Max | Min | Max | Min | Max | |
| t _{pd} | A | Y | 0.8V | — | 14.7 | — | — | — | — | — | ns |
| | | | 1.2V ± 0.1V | 2.5 | 5.1 | 9.0 | 2.5 | 11.2 | 2.5 | 12.3 | |
| | | | 1.5V ± 0.1V | 2.0 | 3.8 | 6.1 | 2.0 | 7.4 | 2.0 | 8.1 | |
| | | | 1.8V ± 0.15V | 1.7 | 3.6 | 4.8 | 1.7 | 6.1 | 1.7 | 6.7 | |
| | | | 2.5V ± 0.2V | 1.4 | 3.3 | 4.5 | 1.4 | 4.8 | 1.4 | 5.3 | |
| | | | 3.3V ± 0.3V | 1.2 | 3.1 | 4.2 | 1.2 | 4.5 | 1.2 | 5.0 | |

 $C_L = 15\text{pF}$, See Figure 1

| Parameter | From Input | TO OUTPUT | V _{cc} | T _A = +25°C | | | T _A = -40°C to +85°C | | T _A = -40°C to +125°C | | Unit |
|-----------------|------------|-----------|-----------------|------------------------|------|------|---------------------------------|------|----------------------------------|------|------|
| | | | | Min | Typ | Max | Min | Max | Min | Max | |
| t _{pd} | A | Y | 0.8V | — | 17.7 | — | — | — | — | — | ns |
| | | | 1.2V ± 0.1V | 2.9 | 6.1 | 10.4 | 2.9 | 13.1 | 2.9 | 14.5 | |
| | | | 1.5V ± 0.1V | 2.3 | 4.5 | 6.8 | 2.3 | 8.6 | 2.3 | 9.4 | |
| | | | 1.8V ± 0.15V | 2.1 | 4.4 | 6.7 | 2.1 | 7.8 | 2.1 | 8.6 | |
| | | | 2.5V ± 0.2V | 1.7 | 4.2 | 5.9 | 1.7 | 6.8 | 1.7 | 6.9 | |
| | | | 3.3V ± 0.3V | 1.5 | 4.0 | 5.7 | 1.5 | 6.1 | 1.5 | 6.7 | |

 $C_L = 30\text{pF}$, See Figure 1

| Parameter | From Input | TO OUTPUT | V _{cc} | T _A = +25°C | | | T _A = -40°C to +85°C | | T _A = -40°C to +125°C | | Unit |
|-----------------|------------|-----------|-----------------|------------------------|------|------|---------------------------------|------|----------------------------------|------|------|
| | | | | Min | Typ | Max | Min | Max | Min | Max | |
| t _{pd} | A | Y | 0.8V | — | 24.6 | — | — | — | — | — | ns |
| | | | 1.2V ± 0.1V | 3.9 | 9.0 | 15.6 | 3.9 | 18.8 | 3.9 | 20.7 | |
| | | | 1.5V ± 0.1V | 3.2 | 7.5 | 13.4 | 3.2 | 13.7 | 3.2 | 13.7 | |
| | | | 1.8V ± 0.15V | 2.9 | 6.8 | 12.4 | 2.9 | 12.6 | 2.9 | 12.6 | |
| | | | 2.5V ± 0.2V | 2.5 | 6.5 | 10.7 | 2.5 | 10.9 | 2.5 | 12.1 | |
| | | | 3.3V ± 0.3V | 2.3 | 6.4 | 9.7 | 2.3 | 10.4 | 2.3 | 11.4 | |

Operating and Package Characteristics (@ $T_A = +25^\circ\text{C}$, unless otherwise specified.)

| Parameter | | Test Conditions | | V _{CC} | Typ | Unit |
|-----------------|---|---|----------|-----------------|-----|------|
| C _{pd} | Power Dissipation Capacitance | f = 1MHz No Load | | 0.8V | 2.6 | pF |
| | | | | 1.2V ± 0.1V | 2.8 | |
| | | | | 1.5V ± 0.1V | 2.9 | |
| | | | | 1.8V ± 0.15V | 3.1 | |
| | | | | 2.5V ± 0.2V | 3.6 | |
| | | | | 3.3V ± 0.3V | 4.2 | |
| C _i | Input Capacitance | V _i = V _{CC} or GND | | 0V or 3.3V | 1.5 | pF |
| θ _{JA} | Thermal Resistance Junction-to-Ambient | SOT353 | (Note 9) | — | 371 | °C/W |
| | | X2-DFN0808-4 | | — | 430 | |
| | | X1-DFN1010-6 | | — | 435 | |
| | | X2-DFN1010-6 | | — | 445 | |
| | | X2-DFN1409-6 | | — | 470 | |
| | | X2-DFN1410-6 | | — | 460 | |
| θ _{JC} | Thermal Resistance Junction-to-Case | SOT353 | (Note 9) | — | 143 | °C/W |
| | | X2-DFN0808-4 | | — | 240 | |
| | | X1-DFN1010-6 | | — | 250 | |
| | | X2-DFN1010-6 | | — | 250 | |
| | | X2-DFN1409-6 | | — | 275 | |
| | | X2-DFN1410-6 | | — | 265 | |

Note: 9. Test condition for each of the six package types: Device mounted on FR-4 substrate PC board, 2oz copper, with minimum recommended pad layout.

Parameter Measurement Information

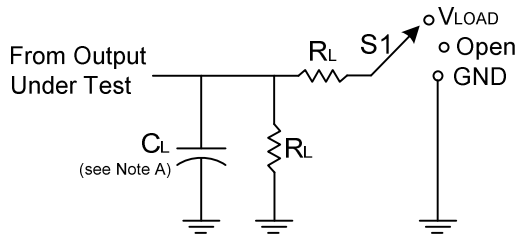

| TEST | S1 | RL |
|-------------------|-------|-----|
| t_{PLZ}/t_{PZL} | Vload | 5kΩ |

| V _{CC} | Inputs | | V _M | V _{LOAD} | C _L | V _Δ |
|-----------------|-----------------|--------------------------------|--------------------|---------------------|-----------------|----------------|
| | V _I | t _r /t _f | | | | |
| 0.8V | V _{CC} | ≤3ns | V _{CC} /2 | 2 X V _{CC} | 5, 10, 15, 30pF | 0.1V |
| 1.2V±0.1V | V _{CC} | ≤3ns | V _{CC} /2 | 2 X V _{CC} | 5, 10, 15, 30pF | 0.1V |
| 1.5V±0.1V | V _{CC} | ≤3ns | V _{CC} /2 | 2 X V _{CC} | 5, 10, 15, 30pF | 0.1V |
| 1.8V±0.15V | V _{CC} | ≤3ns | V _{CC} /2 | 2 X V _{CC} | 5, 10, 15, 30pF | 0.15V |
| 2.5V±0.2V | V _{CC} | ≤3ns | V _{CC} /2 | 2 X V _{CC} | 5, 10, 15, 30pF | 0.15V |
| 3.3V±0.3V | V _{CC} | ≤3ns | V _{CC} /2 | 2 X V _{CC} | 5, 10, 15, 30pF | 0.3V |

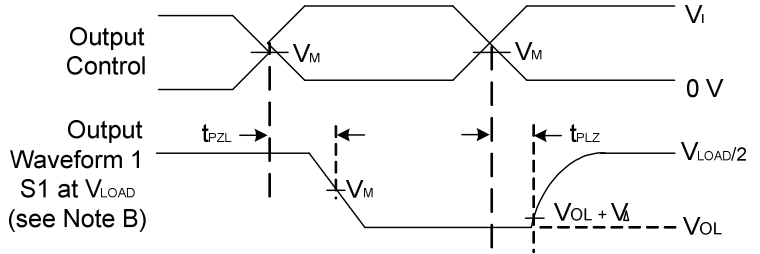
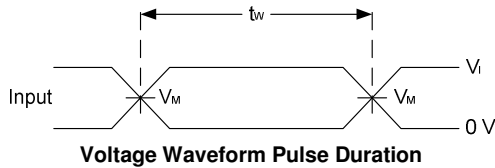

Figure 1 Load Circuit and Voltage Waveforms

- Notes:
- A. Includes test lead and test apparatus capacitance.
 - B. All pulses are supplied at pulse repetition rate ≤ 10 MHz.
 - C. Inputs are measured separately one transition per measurement.
 - D. For the open drain device the specified propagation delay t_{PD} is the same as t_{PLZ} and t_{PZL} .

Marking Information

(1) SOT353

(Top View)

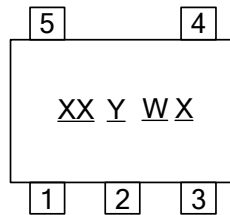

XX : Identification code
Y : Year 0~9
W : Week : A~Z : 1~26 week;
a~z : 27~52 week; z represents
52 and 53 week
X : A~Z : Internal code

| Part Number | Package | Identification Code |
|---------------|---------|---------------------|
| 74AUP1G07SE-7 | SOT353 | XN |

(2) X2-DFN0808-4, X1-DFN1010-6, X2-DFN1010-6, X2-DFN1409-6 and X2-DFN1410-6

(Top View)

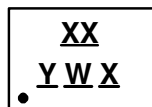

XX : Identification Code
Y : Year : 0~9
W : Week : A~Z : 1~26 week;
a~z : 27~52 week; z represents
52 and 53 week
X : A~Z : Internal code

| Part Number | Package | Identification Code |
|----------------|--------------|---------------------|
| 74AUP1G07FS3-7 | X2-DFN0808-4 | YN |
| 74AUP1G07FW5-7 | X1-DFN1010-6 | Q6 |
| 74AUP1G07FW4-7 | X2-DFN1010-6 | XN |
| 74AUP1G07FX4-7 | X2-DFN1409-6 | HE |
| 74AUP1G07FZ4-7 | X2-DFN1410-6 | XN |

SOT353 Package Outline Dimensions and Suggested Pad Layout

Please see AP02002 at <http://www.diodes.com/datasheets/ap02002.pdf> for the latest version.

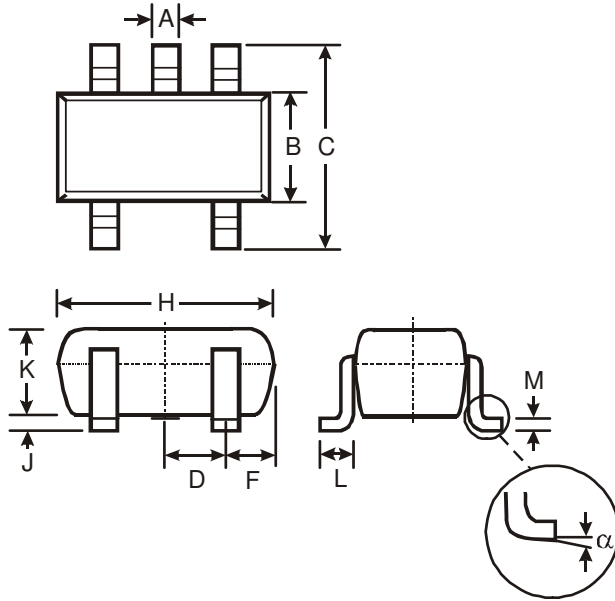

| SOT353 | | | |
|--------|----------|------|-------|
| Dim | Min | Max | Typ |
| A | 0.10 | 0.30 | 0.25 |
| B | 1.15 | 1.35 | 1.30 |
| C | 2.00 | 2.20 | 2.10 |
| D | 0.65 Typ | | |
| F | 0.40 | 0.45 | 0.425 |
| H | 1.80 | 2.20 | 2.15 |
| J | 0 | 0.10 | 0.05 |
| K | 0.90 | 1.00 | 1.00 |
| L | 0.25 | 0.40 | 0.30 |
| M | 0.10 | 0.22 | 0.11 |
| α | 0° | 8° | - |

All Dimensions in mm

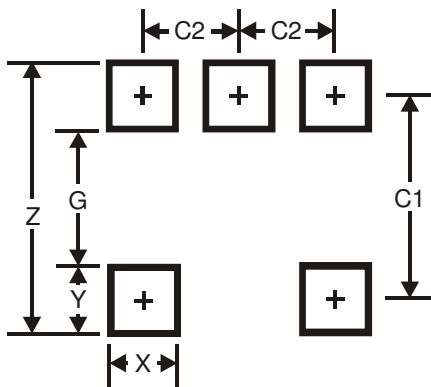

| Dimensions | Value (in mm) |
|------------|---------------|
| Z | 2.5 |
| G | 1.3 |
| X | 0.42 |
| Y | 0.6 |
| C1 | 1.9 |
| C2 | 0.65 |

X2-DFN0808-4 Package Outline Dimensions and Suggested Pad Layout

Please see AP02002 at <http://www.diodes.com/datasheets/ap02002.pdf> for the latest version.

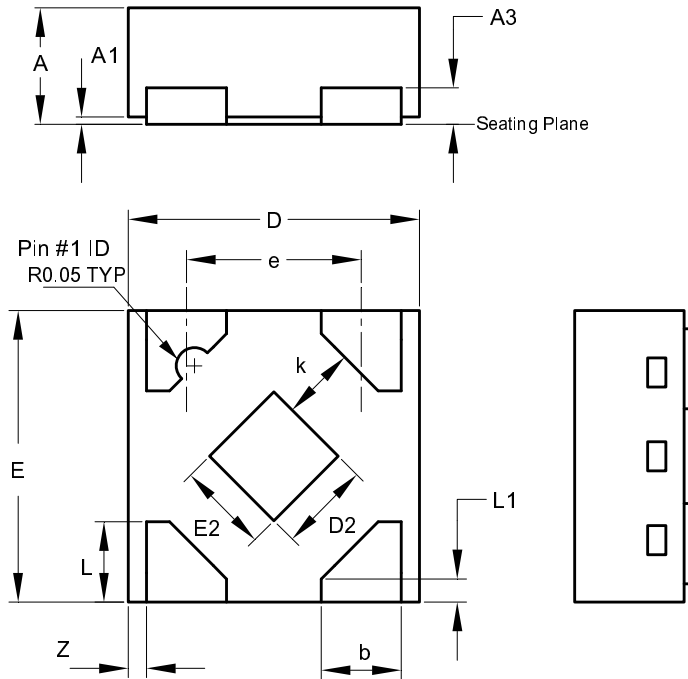

| X2-DFN0808-4 | | | |
|----------------------|------|------|------|
| Dim | Min | Max | Typ |
| A | 0.25 | 0.35 | 0.30 |
| A1 | 0 | 0.04 | 0.02 |
| A3 | - | - | 0.13 |
| b | 0.17 | 0.27 | 0.22 |
| D | 0.75 | 0.85 | 0.80 |
| D2 | 0.15 | 0.35 | 0.25 |
| E | 0.75 | 0.85 | 0.80 |
| E2 | 0.15 | 0.35 | 0.25 |
| e | - | - | 0.48 |
| K | 0.20 | - | - |
| L | 0.17 | 0.27 | 0.22 |
| L1 | 0.02 | 0.12 | 0.07 |
| Z | - | - | 0.05 |
| All Dimensions in mm | | | |

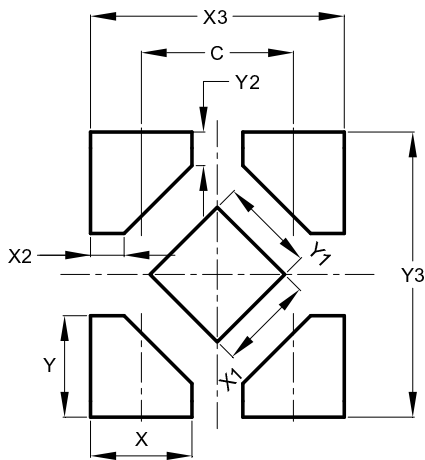

| Dimensions | Value |
|------------|-------|
| C | 0.480 |
| X | 0.320 |
| X1 | 0.300 |
| X2 | 0.106 |
| X3 | 0.800 |
| Y | 0.320 |
| Y1 | 0.300 |
| Y2 | 0.106 |
| Y3 | 0.900 |

X1-DFN1010-6 (Type B) Package Outline Dimensions and Suggested Pad Layout

Please see AP02002 at <http://www.diodes.com/datasheets/ap02002.pdf> for the latest version.

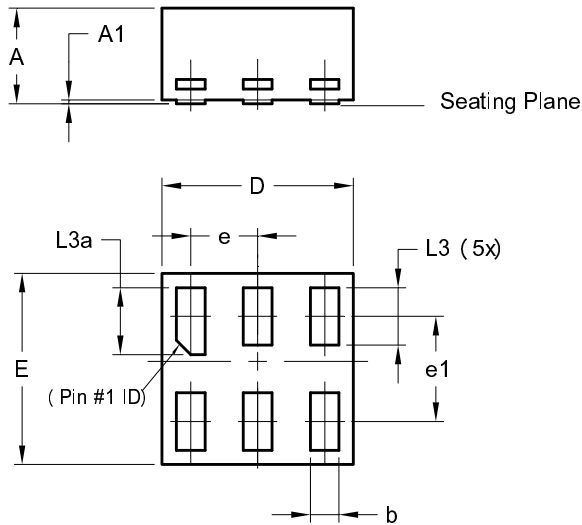

| X1-DFN1010-6 (Type B) | | | |
|--------------------------|----------|-------|------|
| Dim | Min | Max | Typ |
| A | - | 0.50 | 0.39 |
| A1 | - | 0.04 | - |
| b | 0.12 | 0.20 | 0.15 |
| D | 0.95 | 1.050 | 1.00 |
| E | 0.95 | 1.050 | 1.00 |
| e | 0.35 BSC | | |
| e1 | 0.55 BSC | | |
| L3 | 0.27 | 0.30 | 0.30 |
| L3a | 0.32 | 0.40 | 0.35 |
| All Dimensions in mm | | | |

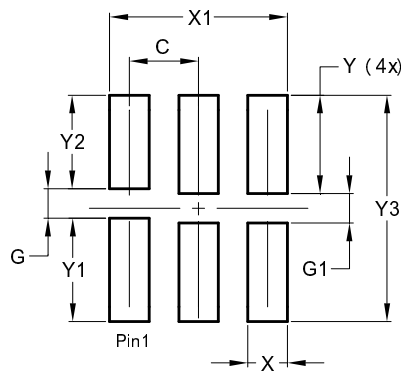

| Dimensions | Value (in mm) |
|------------|------------------|
| C | 0.350 |
| G | 0.150 |
| G1 | 0.150 |
| X | 0.200 |
| X1 | 0.900 |
| Y | 0.500 |
| Y1 | 0.525 |
| Y2 | 0.475 |
| Y3 | 1.150 |

X2-DFN1010-6 Package Outline Dimensions and Suggested Pad Layout

Please see AP02002 at <http://www.diodes.com/datasheets/ap02002.pdf> for the latest version.

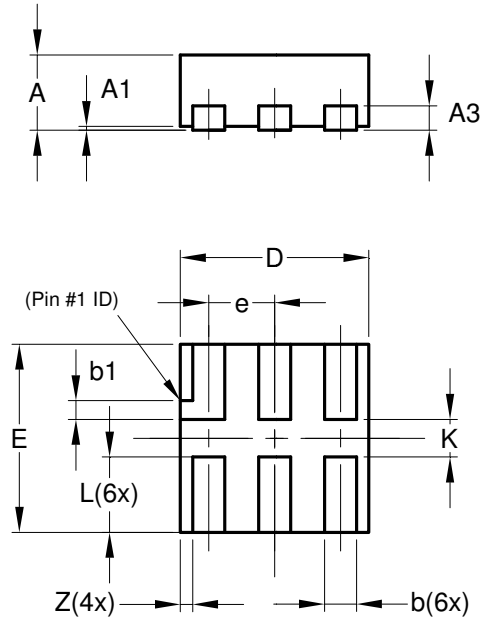

| X2-DFN1010-6 | | | |
|-----------------------------|------|------|-------|
| Dim | Min | Max | Typ |
| A | — | 0.40 | 0.39 |
| A1 | 0.00 | 0.05 | 0.02 |
| A3 | — | — | 0.13 |
| b | 0.14 | 0.20 | 0.17 |
| b1 | 0.05 | 0.15 | 0.10 |
| D | 0.95 | 1.05 | 1.00 |
| E | 0.95 | 1.05 | 1.00 |
| e | — | — | 0.35 |
| L | 0.35 | 0.45 | 0.40 |
| K | 0.15 | — | — |
| Z | — | — | 0.065 |
| All Dimensions in mm | | | |

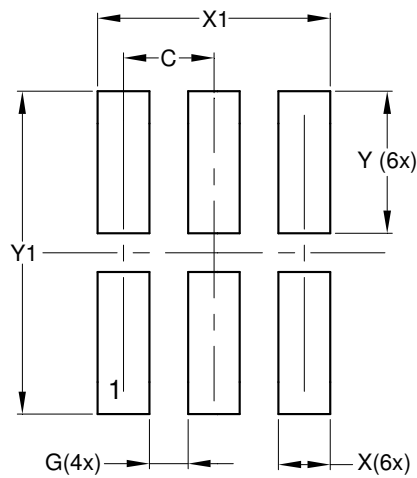

| Dimensions | Value (in mm) |
|------------|---------------|
| C | 0.350 |
| G | 0.150 |
| X | 0.200 |
| X1 | 0.900 |
| Y | 0.550 |
| Y1 | 1.250 |

X2-DFN1409-6 Package Outline Dimensions and Suggested Pad Layout

Please see AP02002 at <http://www.diodes.com/datasheets/ap02002.pdf> for the latest version.

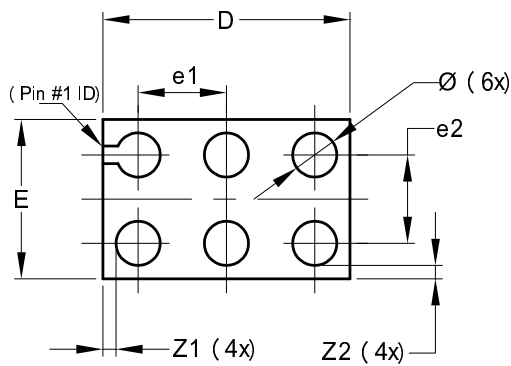
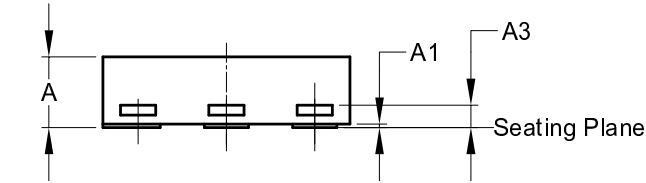

| X2-DFN1409-6 | | | |
|----------------------|------|------|-------|
| Dim | Min | Max | Typ |
| A | - | 0.40 | 0.39 |
| A1 | 0 | 0.05 | 0.02 |
| A3 | - | - | 0.13 |
| Ø | 0.20 | 0.30 | 0.25 |
| D | 1.35 | 1.45 | 1.40 |
| E | 0.85 | 0.95 | 0.90 |
| e1 | - | - | 0.50 |
| e2 | - | - | 0.50 |
| Z1 | - | - | 0.075 |
| Z2 | - | - | 0.075 |
| All Dimensions in mm | | | |

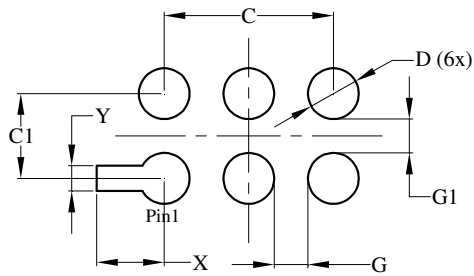

| Dimensions | Value (in mm) |
|------------|---------------|
| C | 1.000 |
| C1 | 0.500 |
| D | 0.300 |
| G | 0.200 |
| G1 | 0.200 |
| X | 0.400 |
| Y | 0.150 |

X2-DFN1410-6 Package Outline Dimensions and Suggested Pad Layout

Please see AP02002 at <http://www.diodes.com/datasheets/ap02002.pdf> for the latest version.

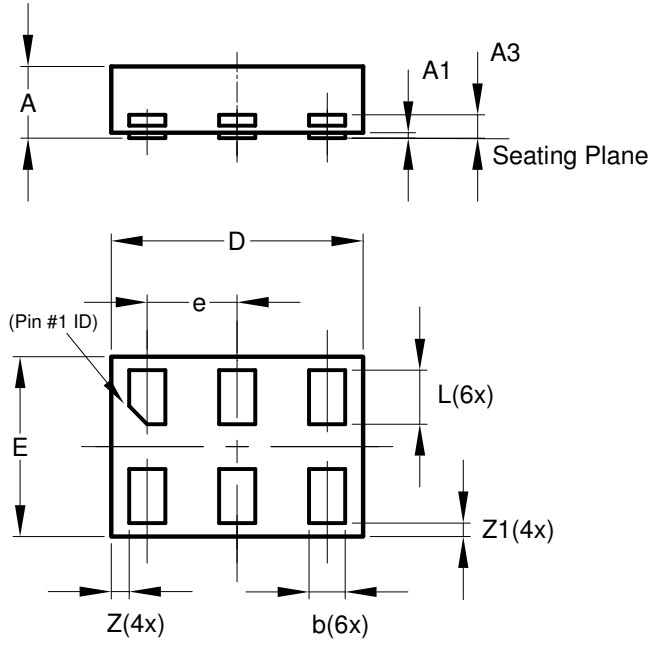

| X2-DFN1410-6 | | | |
|----------------------|-------|-------|-------|
| Dim | Min | Max | Typ |
| A | — | 0.40 | 0.39 |
| A1 | 0.00 | 0.05 | 0.02 |
| A3 | — | — | 0.13 |
| b | 0.15 | 0.25 | 0.20 |
| D | 1.35 | 1.45 | 1.40 |
| E | 0.95 | 1.05 | 1.00 |
| e | — | — | 0.50 |
| L | 0.25 | 0.35 | 0.30 |
| Z | — | — | 0.10 |
| Z1 | 0.045 | 0.105 | 0.075 |
| All Dimensions in mm | | | |

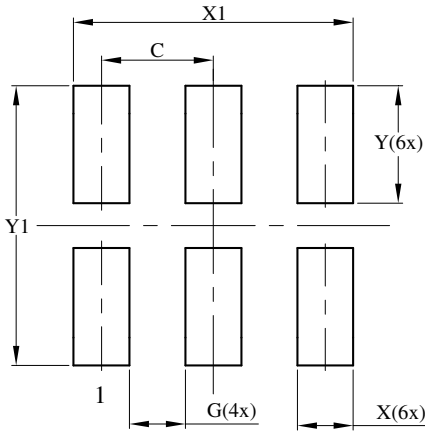

| Dimensions | Value (in mm) |
|------------|---------------|
| C | 0.500 |
| G | 0.250 |
| X | 0.250 |
| X1 | 1.250 |
| Y | 0.525 |
| Y1 | 1.250 |

IMPORTANT NOTICE

DIODES INCORPORATED MAKES NO WARRANTY OF ANY KIND, EXPRESS OR IMPLIED, WITH REGARDS TO THIS DOCUMENT, INCLUDING, BUT NOT LIMITED TO, THE IMPLIED WARRANTIES OF MERCHANTABILITY AND FITNESS FOR A PARTICULAR PURPOSE (AND THEIR EQUIVALENTS UNDER THE LAWS OF ANY JURISDICTION).

Diodes Incorporated and its subsidiaries reserve the right to make modifications, enhancements, improvements, corrections or other changes without further notice to this document and any product described herein. Diodes Incorporated does not assume any liability arising out of the application or use of this document or any product described herein; neither does Diodes Incorporated convey any license under its patent or trademark rights, nor the rights of others. Any Customer or user of this document or products described herein in such applications shall assume all risks of such use and will agree to hold Diodes Incorporated and all the companies whose products are represented on Diodes Incorporated website, harmless against all damages.

Diodes Incorporated does not warrant or accept any liability whatsoever in respect of any products purchased through unauthorized sales channel.

Should Customers purchase or use Diodes Incorporated products for any unintended or unauthorized application, Customers shall indemnify and hold Diodes Incorporated and its representatives harmless against all claims, damages, expenses, and attorney fees arising out of, directly or indirectly, any claim of personal injury or death associated with such unintended or unauthorized application.

Products described herein may be covered by one or more United States, international or foreign patents pending. Product names and markings noted herein may also be covered by one or more United States, international or foreign trademarks.

This document is written in English but may be translated into multiple languages for reference. Only the English version of this document is the final and determinative format released by Diodes Incorporated.

LIFE SUPPORT

Diodes Incorporated products are specifically not authorized for use as critical components in life support devices or systems without the express written approval of the Chief Executive Officer of Diodes Incorporated. As used herein:

A. Life support devices or systems are devices or systems which:

1. are intended to implant into the body, or
2. support or sustain life and whose failure to perform when properly used in accordance with instructions for use provided in the labeling can be reasonably expected to result in significant injury to the user.

B. A critical component is any component in a life support device or system whose failure to perform can be reasonably expected to cause the failure of the life support device or to affect its safety or effectiveness.

Customers represent that they have all necessary expertise in the safety and regulatory ramifications of their life support devices or systems, and acknowledge and agree that they are solely responsible for all legal, regulatory and safety-related requirements concerning their products and any use of Diodes Incorporated products in such safety-critical, life support devices or systems, notwithstanding any devices- or systems-related information or support that may be provided by Diodes Incorporated. Further, Customers must fully indemnify Diodes Incorporated and its representatives against any damages arising out of the use of Diodes Incorporated products in such safety-critical, life support devices or systems.

Copyright © 2015, Diodes Incorporated

www.diodes.com

Looking for pricing, stock, or lifecycle information?

Click below to explore more details on WIN SOURCE:

 [View 74AUP1G07FS3-7 on WIN SOURCE](#)

 [Diodes Incorporated Information](#)

Optimize Your Supply Chain with WIN SOURCE Solutions

-  Global Sourcing Solution
-  Obsolete Management
-  Cost Control Management
-  Shortage Management
-  Alternative Solution
-  Excess Inventory Management