



THE DATASHEET OF APT15F50K



N-Channel FREDFET

Power MOS 8™ is a high speed, high voltage N-channel switch-mode power MOSFET. This 'FREDFET' version has a drain-source (body) diode that has been optimized for high reliability in ZVS phase shifted bridge and other circuits through reduced t_{rr} , soft recovery, and high recovery dv/dt capability. Low gate charge, high gain, and a greatly reduced ratio of C_{rSS}/C_{iSS} result in excellent noise immunity and low switching loss. The intrinsic gate resistance and capacitance of the poly-silicon gate structure help control di/dt during switching, resulting in low EMI and reliable paralleling, even when switching at very high frequency.

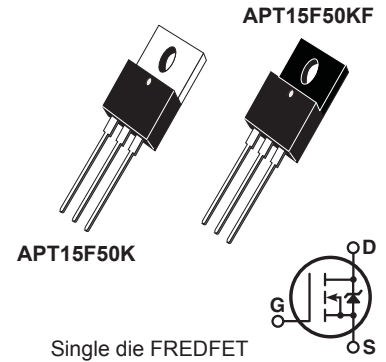

FEATURES

- Fast switching with low EMI
- Low t_{rr} for high reliability
- Ultra low C_{rSS} for improved noise immunity
- Low gate charge
- Avalanche energy rated
- RoHS compliant 

TYPICAL APPLICATIONS

- ZVS phase shifted and other full bridge
- Half bridge
- PFC and other boost converter
- Buck converter
- Single and two switch forward
- Flyback

Absolute Maximum Ratings

Symbol	Parameter	15F50K	15F50KF	Unit
I_D	Continuous Collector Current @ $T_C = 25^\circ\text{C}$	15	6.2	A
	Continuous Collector Current @ $T_C = 100^\circ\text{C}$	10	3.9	
I_{DM}	Pulsed Drain Current ¹	45	18.6	
V_{GS}	Gate-Source Voltage ²	±30		V
E_{AS}	Single Pulse Avalanche Energy ²	305		mJ
I_{AR}	Avalanche Current, Repetitive or Non-Repetitive	7		A

Thermal and Mechanical Characteristics

Symbol	Parameter	Min	Typ	Max	Unit
P_D	Power Dissipation ($T_C = 25^\circ\text{C}$) [K]			223	W
	Power Dissipation ($T_C = 25^\circ\text{C}$) [KF]			37	
$R_{\theta JC}$	Junction to Case Thermal Resistance [K]			0.56	$^\circ\text{C/W}$
$R_{\theta JC}$	Junction to Case Thermal Resistance [KF]			3.3	
$R_{\theta CS}$	Case to Sink Thermal Resistance, Flat, Greased Surface		0.11		
T_J, T_{STG}	Operating and Storage Junction Temperature Range	-55		150	$^\circ\text{C}$
T_L	Soldering Temperature for 10 Seconds (1.6mm from case)			300	
W_T	Package Weight		0.07		oz
			1.2		g
Torque	Mounting Torque (TO-220 Package), 4-40 or M3 screw			10	in·lbf
				1.1	N·m

Static Characteristics
T_J = 25°C unless otherwise specified
APT15F50K_KF

Symbol	Parameter	Test Conditions	Min	Typ	Max	Unit
V _{BR(DSS)}	Drain-Source Breakdown Voltage	V _{GS} = 0V, I _D = 250μA	500			V
ΔV _{BR(DSS)} /ΔT _J	Breakdown Voltage Temperature Coefficient	Reference to 25°C, I _D = 250μA		0.60		V/°C
R _{DS(on)}	Drain-Source On Resistance ^③	V _{GS} = 10V, I _D = 7A		0.33	0.39	Ω
V _{GS(th)}	Gate-Source Threshold Voltage	V _{GS} = V _{DS} , I _D = 0.5mA	2.5	4	5	V
ΔV _{GS(th)} /ΔT _J	Threshold Voltage Temperature Coefficient			-10		mV/°C
I _{DSS}	Zero Gate Voltage Drain Current	V _{DS} = 500V V _{GS} = 0V			250	μA
		T _J = 25°C T _J = 125°C			1000	
I _{GSS}	Gate-Source Leakage Current	V _{GS} = ±30V			±100	nA

Dynamic Characteristics
T_J = 25°C unless otherwise specified

Symbol	Parameter	Test Conditions	Min	Typ	Max	Unit
g _{fs}	Forward Transconductance	V _{DS} = 50V, I _D = 7A		11		S
C _{iss}	Input Capacitance	V _{GS} = 0V, V _{DS} = 25V f = 1MHz		2250		pF
C _{rss}	Reverse Transfer Capacitance			30		
C _{oss}	Output Capacitance			240		
C _{o(cr)} ^④	Effective Output Capacitance, Charge Related			140		
C _{o(er)} ^⑤	Effective Output Capacitance, Energy Related	V _{GS} = 0V, V _{DS} = 0V to 333V		70		
Q _g	Total Gate Charge	V _{GS} = 0 to 10V, I _D = 7A, V _{DS} = 250V		55		nC
Q _{gs}	Gate-Source Charge			13		
Q _{gd}	Gate-Drain Charge			26		
t _{d(on)}	Turn-On Delay Time	Resistive Switching V _{DD} = 333V, I _D = 7A R _G = 10Ω ^⑥ , V _{GG} = 15V		10		ns
t _r	Current Rise Time			12		
t _{d(off)}	Turn-Off Delay Time			26		
t _f	Current Fall Time			8		

Source-Drain Diode Characteristics

Symbol	Parameter	Test Conditions	Min	Typ	Max	Unit
I _S	Continuous Source Current (Body Diode)	MOSFET symbol showing the integral reverse p-n junction diode (body diode)			15	A
I _{SM}	Pulsed Source Current (Body Diode) ^①				45	A
V _{SD}	Diode Forward Voltage ^③	I _{SD} = 7A, T _J = 25°C, V _{GS} = 0V			1.0	V
t _{rr}	Reverse Recovery Time	I _{SD} = 7A ^② V _{DD} = 100V di _{SD} /dt = 100A/μs	T _J = 25°C		190	ns
			T _J = 125°C		340	
Q _{rr}	Reverse Recovery Charge	I _{SD} = 7A ^② V _{DD} = 100V di _{SD} /dt = 100A/μs	T _J = 25°C	0.54		μC
			T _J = 125°C	1.27		
I _{rrm}	Reverse Recovery Current	I _{SD} = 7A ^② V _{DD} = 100V di _{SD} /dt = 100A/μs	T _J = 25°C	5.9		A
			T _J = 125°C	7.9		
dv/dt	Peak Recovery dv/dt	I _{SD} ≤ 7A, di/dt ≤ 1000A/μs, V _{DD} = 333V, T _J = 125°C			20	V/ns

① Repetitive Rating: Pulse width and case temperature limited by maximum junction temperature.

② Starting at T_J = 25°C, L = 12.45mH, R_G = 25Ω, I_{AS} = 7A.

③ Pulse test: Pulse Width < 380μs, duty cycle < 2%.

④ C_{o(cr)} is defined as a fixed capacitance with the same stored charge as C_{OSS} with V_{DS} = 67% of V_{(BR)DSS}.

⑤ C_{o(er)} is defined as a fixed capacitance with the same stored energy as C_{OSS} with V_{DS} = 67% of V_{(BR)DSS}. To calculate C_{o(er)} for any value of V_{DS} less than V_{(BR)DSS}, use this equation: C_{o(er)} = -5.22E-8/V_{DS}² + 1.21E-8/V_{DS} + 3.48E-11.

⑥ R_G is external gate resistance, not including internal gate resistance or gate driver impedance. (MIC4452)

Microsemi reserves the right to change, without notice, the specifications and information contained herein.

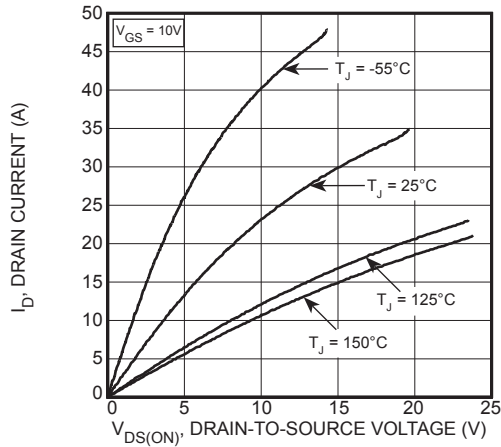

Figure 1, Output Characteristics

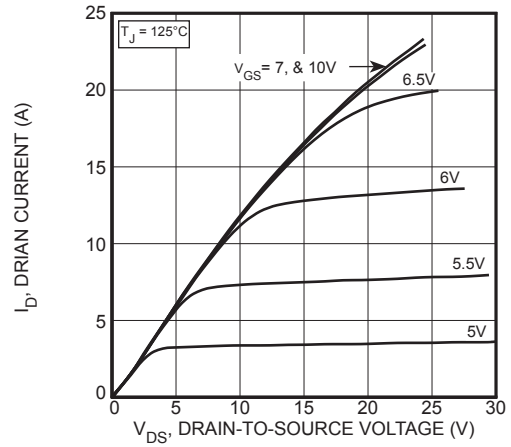

Figure 2, Output Characteristics

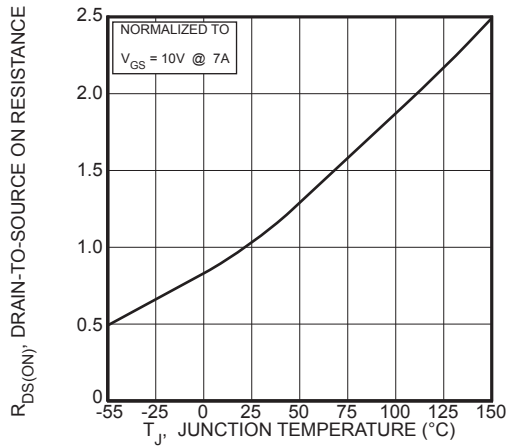

Figure 3, $R_{DS(ON)}$ vs Junction Temperature

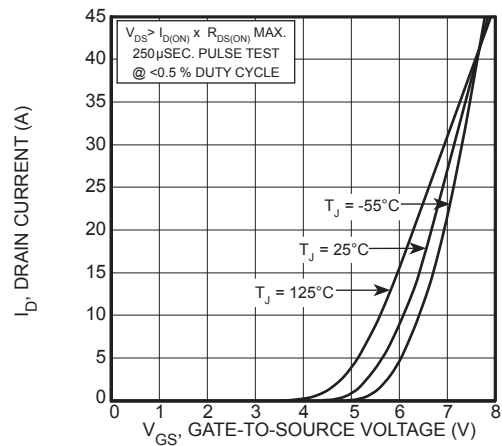

Figure 4, Transfer Characteristics

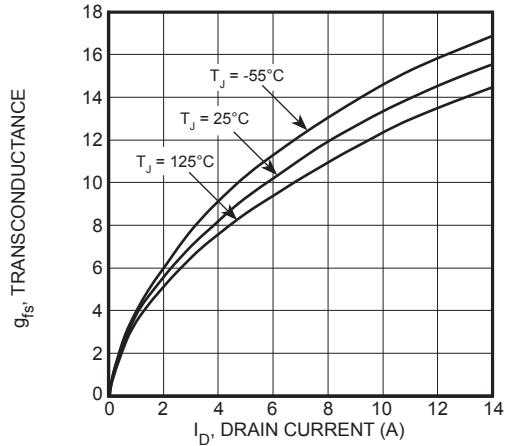

Figure 5, Gain vs Drain Current

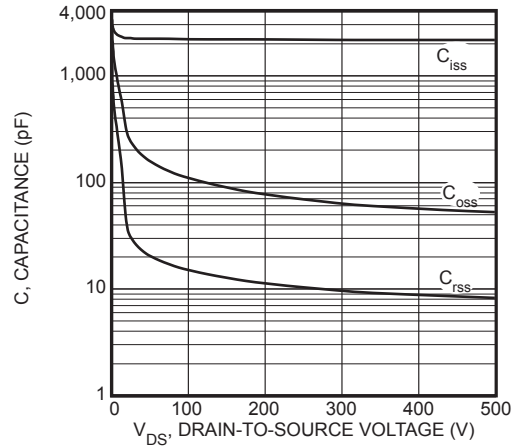

Figure 6, Capacitance vs Drain-to-Source Voltage

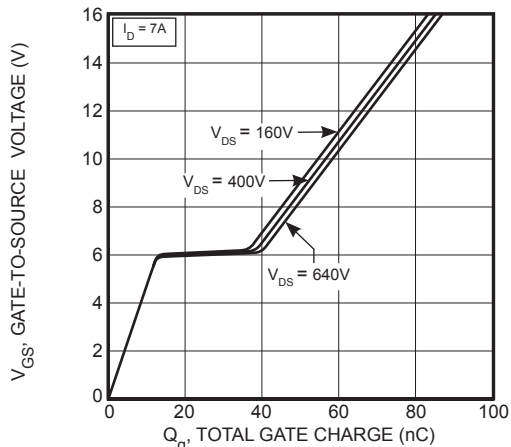

Figure 7, Gate Charge vs Gate-to-Source Voltage

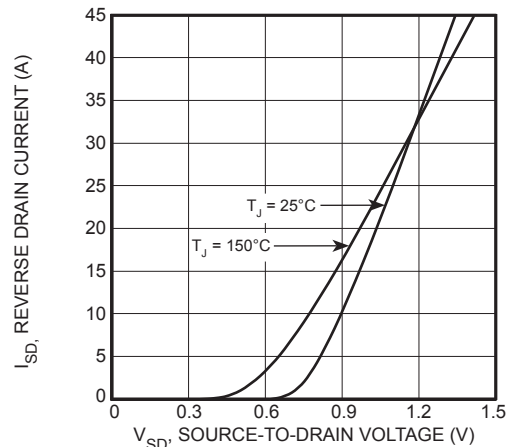

Figure 8, Reverse Drain Current vs Source-to-Drain Voltage

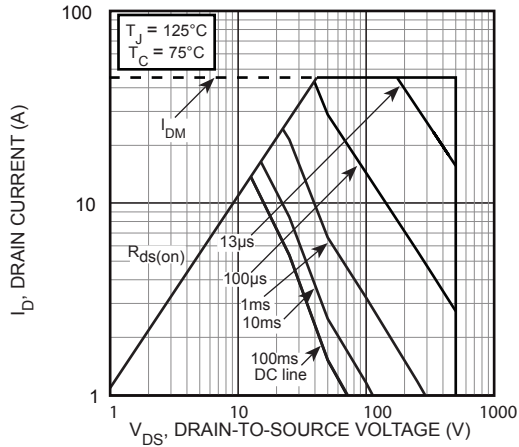

Figure 9, 15F50K Forward Safe Operating Area

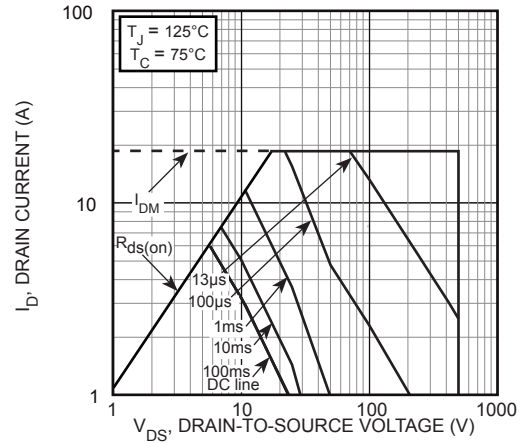

Figure 10, 15F50KF Forward Safe Operating Area

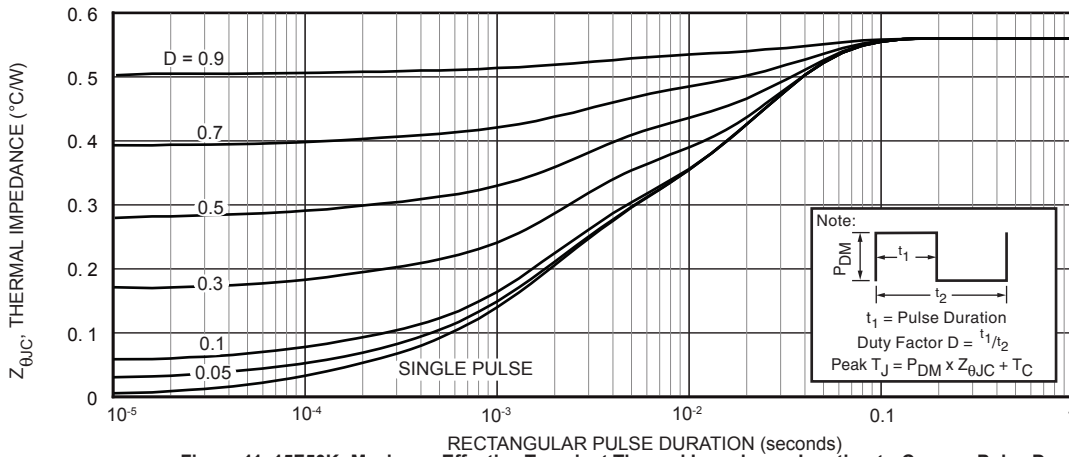

Figure 11, 15F50K -Maximum Effective Transient Thermal Impedance Junction-to-Case vs Pulse Duration

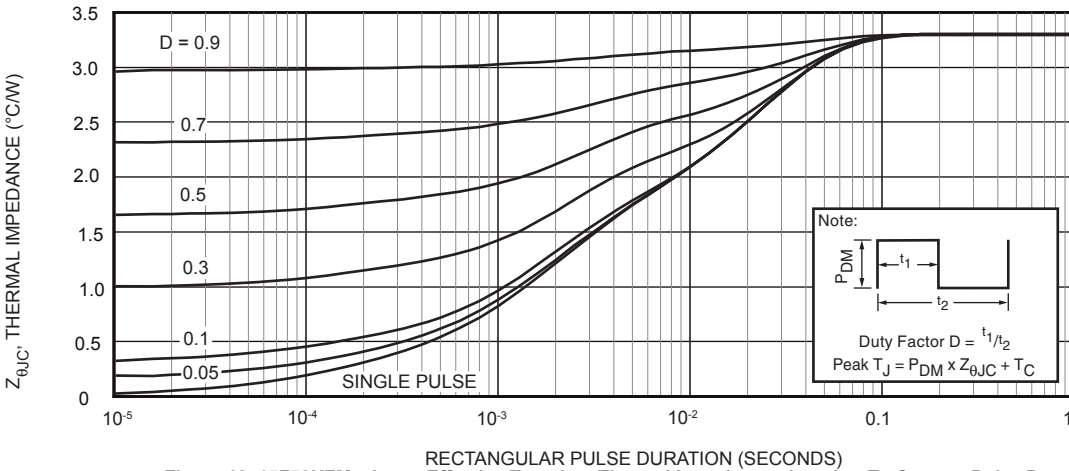
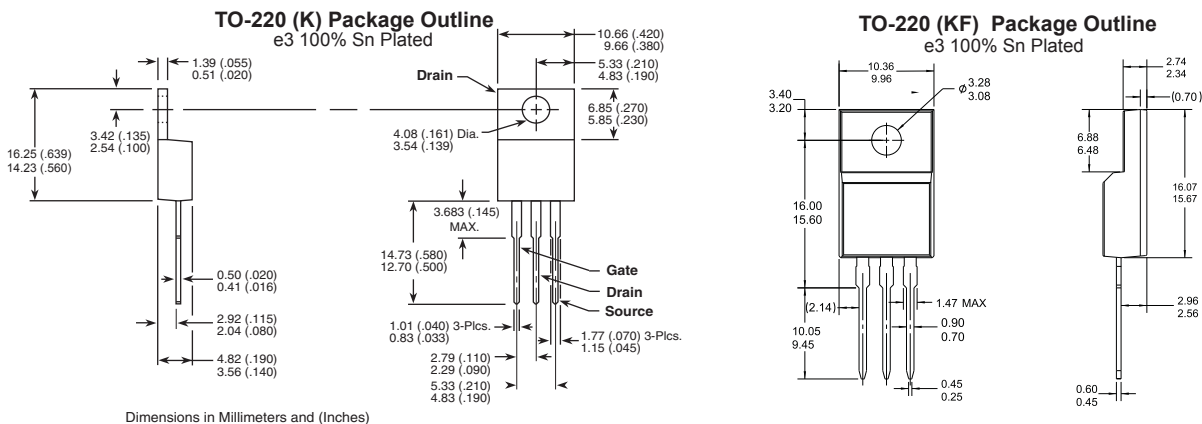

Figure 12, 15F50KF Maximum Effective Transient Thermal Impedance, Junction-To-Case vs. Pulse Duration



050-8145 Rev E 3-2010

Looking for pricing, stock, or lifecycle information?

Click below to explore more details on WIN SOURCE:

- ⊖ [View APT15F50K on WIN SOURCE](#)
- ⊖ [Microsemi Corporation Information](#)

Optimize Your Supply Chain with WIN SOURCE Solutions

- ✓ Global Sourcing Solution
- ✓ Obsolete Management
- ✓ Cost Control Management
- ✓ Shortage Management
- ✓ Alternative Solution
- ✓ Excess Inventory Management