



**THE DATASHEET OF
DDTA124XUA-7-F**



Features

- Epitaxial Planar Die Construction
- Complementary NPN Types Available (DDTC)
- Built-In Biasing Resistors, R1≠R2
- Lead Free/RoHS Compliant (Note 1)
- "Green" Device (Note 2 & 3)

Mechanical Data

- Case: SOT-323
- Case Material: Molded Plastic, "Green" Molding Compound, Note 3. UL Flammability Classification Rating 94V-0
- Moisture Sensitivity: Level 1 per J-STD-020C
- Terminal Connections: See Diagram
- Terminals: Solderable per MIL-STD-202, Method 208
- Lead Free Plating (Matte Tin Finish annealed over Alloy 42 leadframe).
- Marking Information: See Page 4
- Type Code: See Table Below
- Ordering Information: See Page 4
- Weight: 0.006 grams (approximate)

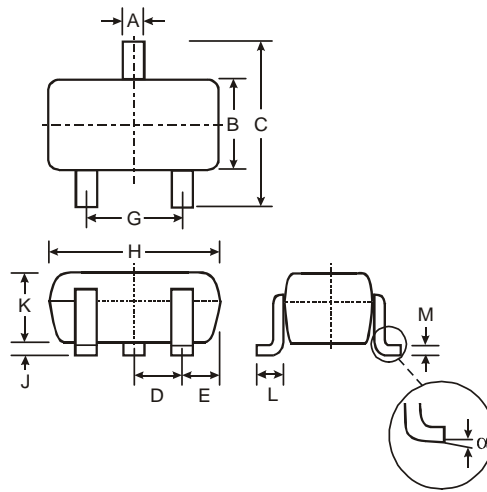

SOT-323		
Dim	Min	Max
A	0.25	0.40
B	1.15	1.35
C	2.00	2.20
D	0.65 Nominal	
E	0.30	0.40
G	1.20	1.40
H	1.80	2.20
J	0.0	0.10
K	0.90	1.00
L	0.25	0.40
M	0.10	0.18
α	0°	8°
All Dimensions in mm		

P/N	R1 (NOM)	R2 (NOM)	Type Code
DDTA113ZUA	1KΩ	10KΩ	P02
DDTA123YUA	2.2KΩ	10KΩ	P05
DDTA123JUA	2.2KΩ	47KΩ	P06
DDTA143XUA	4.7KΩ	10KΩ	P09
DDTA143FUA	4.7KΩ	22KΩ	P10
DDTA143ZUA	4.7KΩ	47KΩ	P11
DDTA114YUA	10KΩ	47KΩ	P14
DDTA114WUA	10KΩ	4.7KΩ	P15
DDTA124XUA	22KΩ	47KΩ	P18
DDTA144VUA	47KΩ	10KΩ	P21
DDTA144WUA	47KΩ	22KΩ	P22

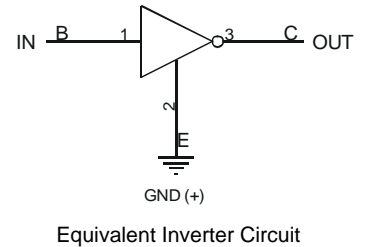
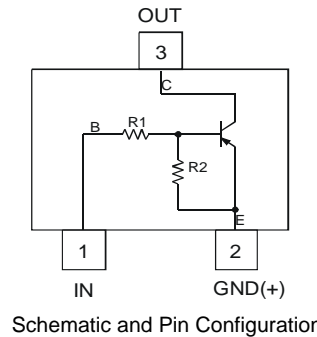

Maximum Ratings @T_A = 25°C unless otherwise specified

Characteristic	Symbol	Value	Unit
Supply Voltage, (3) to (2)	V _{CC}	-50	V
Input Voltage, (1) to (2)	V _{IN}	+5 to -10 +5 to -12 +5 to -12 +7 to -20 +6 to -30 +5 to -30 +6 to -40 +10 to -30 +10 to -40 +15 to -40 +10 to -40	V
Output Current	I _O	-100 -100 -100 -100 -100 -100 -70 -100 -50 -30 -30	mA

- Notes:
1. No purposefully added lead.
 2. Diodes Inc.'s "Green" policy can be found on our website at http://www.diodes.com/products/lead_free/index.php.
 3. Product manufactured with Date Code 0627 (week 27, 2006) and newer are built with Green Molding Compound. Product manufactured prior to Date Code 0627 are built with Non-Green Molding Compound and may contain Halogens or Sb2O3 Fire Retardants.

Maximum Ratings (continued) @T_A = 25°C unless otherwise specified

Characteristic	Symbol	Value	Unit
Output Current	I _C (Max)	-100	mA
Power Dissipation	P _d	200	mW
Thermal Resistance, Junction to Ambient Air (Note 4)	R _{θJA}	625	°C/W
Operating and Storage Temperature Range	T _j , T _{STG}	-55 to +150	°C

Notes: 4. Mounted on FR4 PC Board with recommended pad layout as shown on Diodes Inc., suggested pad layout document AP02001, which can be found on our website at <http://www.diodes.com/datasheets/ap02001.pdf>

Electrical Characteristics @T_A = 25°C unless otherwise specified

Characteristic	Symbol	Min	Typ	Max	Unit	Test Condition				
Input Voltage	V _{I(off)}	-0.3			V	V _{CC} = 5V, I _O = 100μA				
		-0.3								
		-0.5								
		-0.3								
		-0.3								
		-0.5	—	—						
		-0.3								
		-0.8								
		-0.4								
		-1.0								
		-0.8								
		V _{I(on)}	—	—			-3.0		V	V _O = -0.3V, I _O = -20mA V _O = -0.3V, I _O = -20mA V _O = -0.3V, I _O = -5mA V _O = -0.3V, I _O = -20mA V _O = -0.3V, I _O = -3mA V _O = -0.3V, I _O = -5mA V _O = -0.3V, I _O = -1mA V _O = -0.3V, I _O = -2mA V _O = -0.3V, I _O = -2mA V _O = -0.3V, I _O = -2mA V _O = -0.3V, I _O = -2mA
			—	—			-3.0			
	—		—	-1.1						
	—		—	-2.5						
	—		—	-1.3						
	—		—	-1.3						
	—		—	-1.4						
	—		—	-3.0						
	Output Voltage	V _{O(on)}	—	-0.1	-0.3	V	I _O /I _I = -5mA/-0.25mA DDTA123JUA I _O /I _I = -5mA/-0.25mA DDTA143ZUA I _O /I _I = -5mA/-0.25mA DDTA114YUA I _O /I _I = -10mA/-0.5mA All Others			
—			-0.1	-0.3						
—			-0.1	-0.3						
—			-0.1	-0.3						
Input Current	I _I	—	—	-7.2	mA	V _I = -5V				
		—	—	-3.8						
		—	—	-3.6						
		—	—	-1.8						
		—	—	-1.8						
		—	—	-1.8						
		—	—	-0.88						
		—	—	-0.88						
		—	—	-0.36						
		—	—	-0.16						
		—	—	-0.16						
Output Current	I _{O(off)}	—	—	-0.5	μA	V _{CC} = -50V, V _I = 0V				
DC Current Gain	G _I	-33				V _O = -5V, I _O = -10mA				
		-33								
		-80								
		-30								
		-68								
		-80	—	—						
		-68								
		-24								
		-68								
		-33								
		-56								
		Input Resistor Tolerance	ΔR ₁	-30			—	+30	%	—
		Resistance Ratio Tolerance	ΔR ₂ /R ₁	-20			—	+20	%	—
Gain-Bandwidth Product*	f _T	—	250	—	MHz	V _{CE} = -10V, I _E = 5mA, f = 100MHz				

* Transistor - For Reference Only

Typical Curves – DDTA123JUA

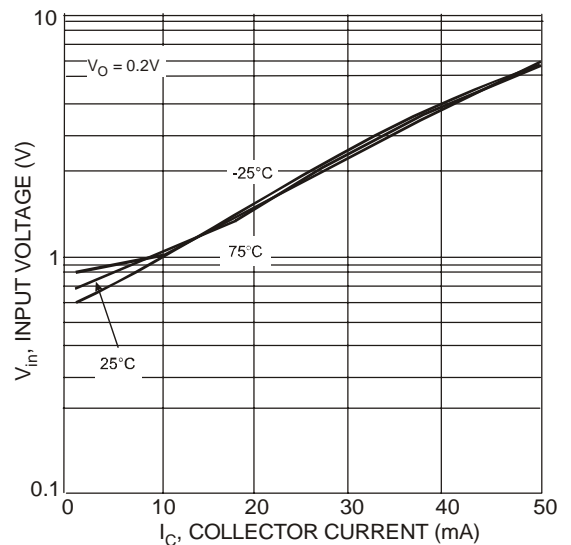
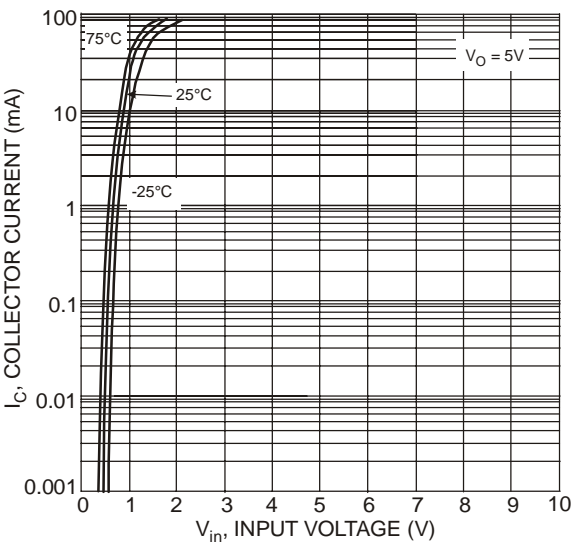
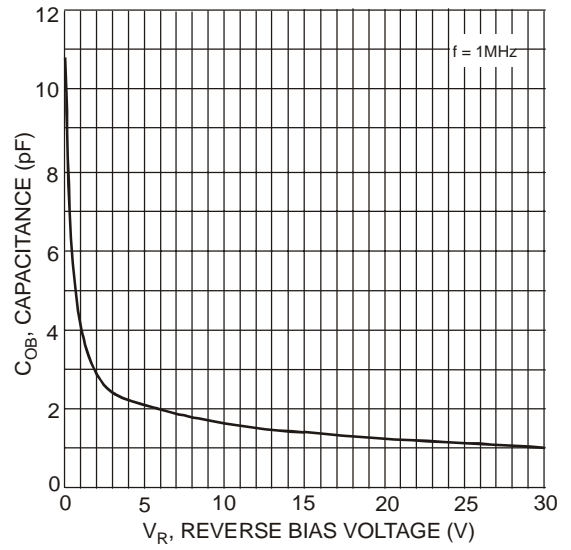
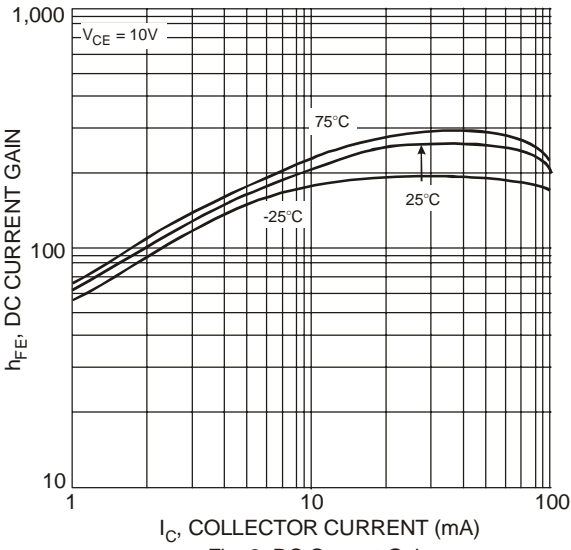
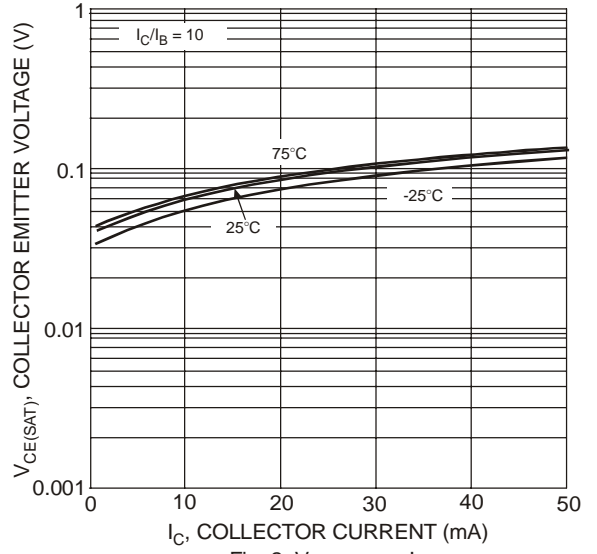
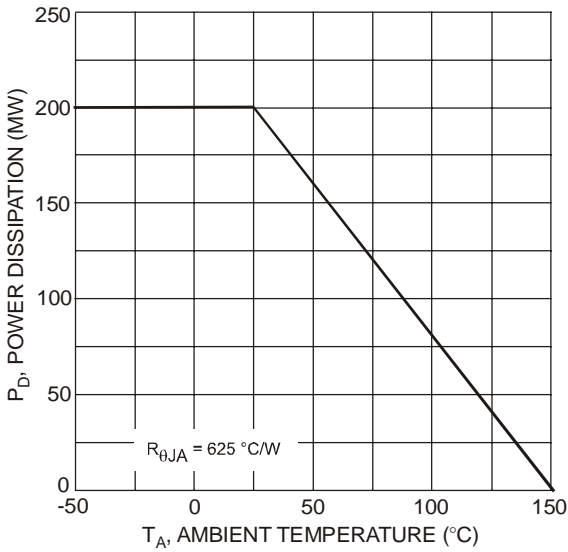

Ordering Information (Note 3 & 5)

Device	Packaging	Shipping
DDTA113ZUA-7-F	SOT-323	3000/Tape & Reel
DDTA123YUA-7-F	SOT-323	3000/Tape & Reel
DDTA123JUA-7-F	SOT-323	3000/Tape & Reel
DDTA143XUA-7-F	SOT-323	3000/Tape & Reel
DDTA143FUA-7-F	SOT-323	3000/Tape & Reel
DDTA143ZUA-7-F	SOT-323	3000/Tape & Reel
DDTA114YUA-7-F	SOT-323	3000/Tape & Reel
DDTA114WUA-7-F	SOT-323	3000/Tape & Reel
DDTA124XUA-7-F	SOT-323	3000/Tape & Reel
DDTA144VUA-7-F	SOT-323	3000/Tape & Reel
DDTA144WUA-7-F	SOT-323	3000/Tape & Reel

Notes: 5. For packaging details, go to our website at <http://www.diodes.com/datasheets/ap02007.pdf>.

Marking Information

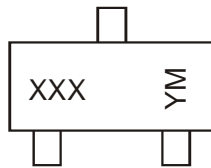

XXX = Product Type Marking Code, See Table on Page 1
 YM = Date Code Marking
 Y = Year ex: T = 2006
 M = Month ex: 9 = September

Date Code Key

Year	2006	2007	2008	2009	2010	2011	2012
Code	T	U	V	W	X	Y	Z

Month	Jan	Feb	Mar	Apr	May	Jun	Jul	Aug	Sep	Oct	Nov	Dec
Code	1	2	3	4	5	6	7	8	9	O	N	D

IMPORTANT NOTICE



Diodes Incorporated and its subsidiaries reserve the right to make modifications, enhancements, improvements, corrections or other changes without further notice to any product herein. Diodes Incorporated does not assume any liability arising out of the application or use of any product described herein; neither does it convey any license under its patent rights, nor the rights of others. The user of products in such applications shall assume all risks of such use and will agree to hold Diodes Incorporated and all the companies whose products are represented on our website, harmless against all damages.

LIFE SUPPORT

Diodes Incorporated products are not authorized for use as critical components in life support devices or systems without the expressed written approval of the President of Diodes Incorporated.

Looking for pricing, stock, or lifecycle information?

Click below to explore more details on WIN SOURCE:

-  [View DDTA124XUA-7-F on WIN SOURCE](#)
-  [Diodes Incorporated Information](#)

Optimize Your Supply Chain with WIN SOURCE Solutions

-  Global Sourcing Solution
-  Obsolete Management
-  Cost Control Management
-  Shortage Management
-  Alternative Solution
-  Excess Inventory Management