



**THE DATASHEET OF
NFZ15SG262SN10D**



CHIP NOISE FILTER NFZ15SG□□□SN1□D REFERENCE SPECIFICATION

1. Scope

This reference specification applies to NFZ15SG Series, Chip Noise Filter.

2. Part Numbering

(ex) NF Z 15 SG 101 S N 1 0 D
 Product ID Structure Dimension Characteristics Typical Impedance Performance Category Numbers of Circuit special specification * B: BULK
 (L × W) at 900MHz at 900MHz 1: LowRdc 0: HighImpedance
 Packaging D:Taping

*B: Bulk packing also available

3. Rating

- Operating Temperature Range – 40°C to + 85°C
- Storage Temperature Range – 40°C to + 85°C

Customer Part Number	MURATA Part Number	Impedance			DC Resistance (Ω)		Rated Current *1 (A)
		at900MHz(Ω)		at1.7GHz(Ω)	Typ.	Max.	
		Typ.	Min.	Typ.			
	NFZ15SG101SN11D	100	70	160	0.07	0.10	1.10
	NFZ15SG151SN11D	150	100	250	0.09	0.12	1.00
	NFZ15SG331SN11D	330	230	540	0.20	0.30	0.65
	NFZ15SG771SN10D	770	530	900	0.35	0.50	0.50
	NFZ15SG152SN10D	1500	1000	1200	0.55	0.80	0.40
	NFZ15SG262SN10D	2600	1800	1450	0.80	1.00	0.35
	NFZ15SG462SN10D	4600	2800	1800	1.25	1.65	0.27

*1: When applied Rated current to the Products, self temperature rise shall be limited to 40°C max.

4. Testing Conditions

《Unless otherwise specified》

Temperature : Ordinary Temperature / 15°C to 35°C
 Humidity : Ordinary Humidity / 25%(RH) to 85%(RH)

《In case of doubt》

Temperature : 20°C ± 2°C
 Humidity : 60%(RH) to 70%(RH)
 Atmospheric Pressure : 86kPa to 106kPa

5. Appearance and Dimensions

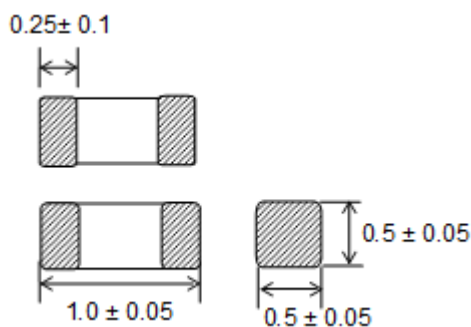

■ Equivalent Circuit

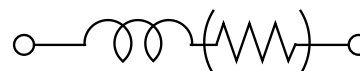

(Resistance element becomes dominant at high frequencies.)

■ Unit Mass (Typical value)
0.001g

(in mm)

6. Electrical Performance

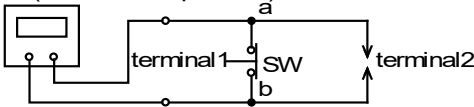
No.	Item	Specification	Test Method
6.1	Impedance	Impedance shall meet item 3.	Measuring Equipment: KEYSIGHT 4991A or equivalent (50mV) Measuring Frequency: 900MHz / 1.7GHz
6.2	DC Resistance	DC Resistance shall meet item 3.	Measuring Equipment: Digital multi meter Digital multi meter (TR6846 or equivalent)  (DC resistance shall be measured after putting chip noise filter between the terminal 2 under the condition of opening between a and b. Every measurement the terminal 1 shall be shorted between a and b when changing noise filter.) *Except resistance of the Substrate and Wire

7. Mechanical Performance

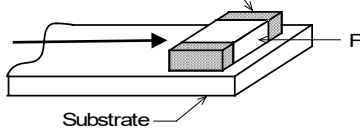
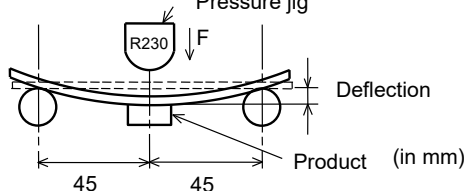
No.	Item	Specification	Test Method
7.1	Shear Test	Chip noise filter shall not be damaged after tested as follows.	Applied Direction CHIP NOISE FILTER  Substrate Force: 5N Hold Duration: 5s±1s Applied Direction: Parallel to PCB
7.2	Bending Test		Substrate: Glass-epoxy substrate (100mm × 40mm × 0.8mm) Solder: Reflow  Pressure jig R230 F Deflection Product (in mm) 45 45 Speed of Applying Force: 0.5mm / s Deflection: 2mm Hold Duration: 30 s
7.3	Vibration		Oscillation Frequency: 10Hz to 2000Hz to 10Hz for 20 min Total amplitude 3.0 mm or Acceleration amplitude 245m/s ² whichever is smaller. Testing Time: A period of 2h in each of 3 mutually perpendicular directions. (Total 6h)
7.4	Drop		It shall be dropped on concrete or steel board. Height : 1m Total of 9 cycles

No.	Item	Specification	Test Method
7.5	Solderability	The wetting area of the electrode shall be at least 90% covered with new solder coating.	Flux: Ethanol solution of rosin 25(wt)% Solder: Sn-3.0Ag-0.5Cu Pre-Heating: 150°C±10°C / 60s to 90s Solder Temperature: 240°C±5°C Immersion Time: 3s±1s
7.6	Resistance to Soldering Heat	Appearance: No damage Impedance Change: within ±30%	Pre-Heating: 150°C±10°C / 60s to 90s Solder: Sn-3.0Ag-0.5Cu Solder Temperature: 270°C±5°C Immersion Time: 10s±1s Then measured after exposure in the room condition for 48h±4h.

8. Environmental Performance

It shall be soldered on the substrate.

No.	Item	Specification	Test Method
8.1	Heat Resistance	Appearance: No damage Impedance Change: within ±30%	Temperature: 85°C±2°C Time: 1000h (+48h,-0h) Then measured after exposure in the room condition for 48h±4h.
8.2	Cold Resistance		Temperature: -40°C±2°C Time: 1000h (+48h,-0h) Then measured after exposure in the room condition for 48h±4h.
8.3	Humidity		Temperature: 40°C±2°C Humidity: 90%(RH) to 95%(RH) Time: 1000h (+48h,-0h) Then measured after exposure in the room condition for 48h±4h.
8.4	Temperature Cycle		1 cycle: 1 step: -40°C±2°C / 30 min±3 min 2 step: Ordinary temp. / 10 min to 15 min 3 step: 85°C±2°C / 30 min to 3 min 4 step: Ordinary temp. / 10 min to 15 min Total of 100cycles Then measured after exposure in the room condition for 48h±4h.

9.5 Dimensions of Leader-tape, Trailer and Reel

There shall be leader-tape (top tape) and trailer-tape (empty tape) as follows.

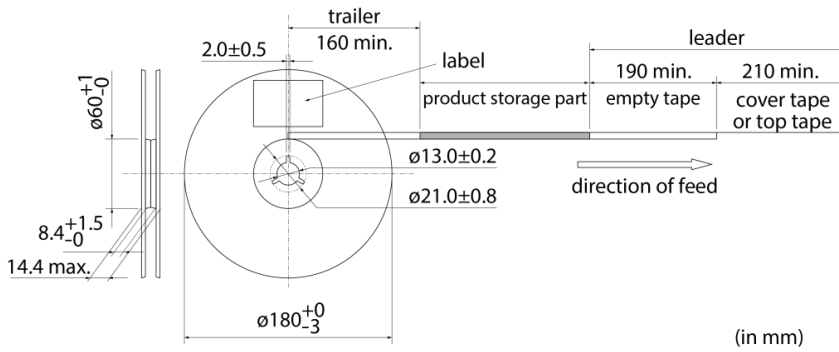

9.6 Marking for reel

Customer part number, MURATA part number, Inspection number (*1), RoHS marking (*2), Quantity etc ...

*1) <Expression of Inspection No.>

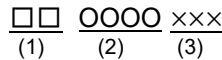

(1) Factory Code

(2) Date First digit : Year / Last digit of year
 Second digit : Month / Jan. to Sep. → 1 to 9, Oct. to Dec. → O, N, D
 Third, Fourth digit : Day

(3) Serial No.

*2) <Expression of RoHS marking >

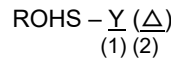

(1) RoHS regulation conformity parts.
 (2) MURATA classification number

9.7 Marking for Outside package (corrugated paper box)

Customer name, Purchasing order number, Customer part number, MURATA part number, RoHS marking (*2), Quantity, etc ...

9.8 Specification of Outer Case

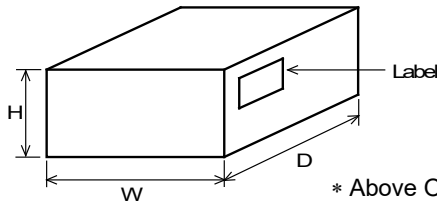

Outer Case Dimensions (mm)			Standard Reel Quantity in Outer Case (Reel)
W	D	H	
186	186	93	5

* Above Outer Case size is typical. It depends on a quantity of an order

10. ⚠ Caution

10.1 Limitation of Applications

Please contact us before using our products for the applications listed below which require especially high reliability for the prevention of defects which might directly cause damage to the third party's life, body or property.

- (1) Aircraft equipment
- (2) Aerospace equipment
- (3) Undersea equipment
- (4) Power plant control equipment
- (5) Medical equipment
- (6) Transportation equipment (vehicles, trains, ships, etc.)
- (7) Traffic signal equipment
- (8) Disaster prevention / crime prevention equipment
- (9) Data-processing equipment
- (10) Applications of similar complexity and /or reliability requirements to the applications listed in the above

10.2 Corrosive gas

Please refrain from use since contact with environments with corrosive gases (sulfur gas [hydrogen sulfide, sulfur dioxide, etc.], chlorine, ammonia, etc.) or oils (cutting oil, silicone oil, etc.) that have come into contact with the previously stated corrosive gas environment will result in deterioration of product quality or an open from deterioration due to corrosion of product electrode, etc. We will not bear any responsibility for use under these environments.

11. Notice

This product is designed for solder mounting.

Please consult us in advance for applying other mounting method such as conductive adhesive.

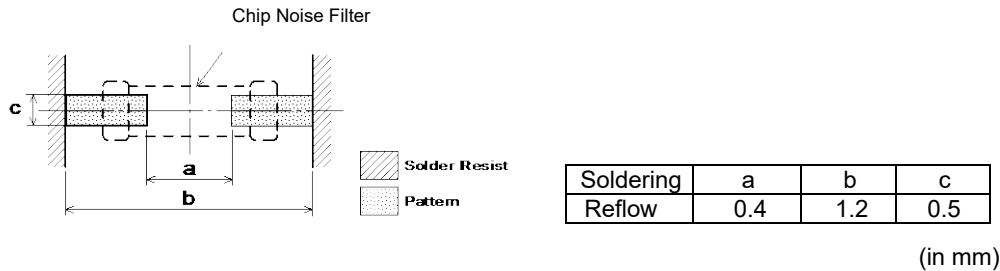
11.1 Land pattern designing**11.2 Flux, Solder**

- Use rosin-based flux.
Don't use highly acidic flux with halide content exceeding 0.2(wt) % (chlorine conversion value).
Don't use water-soluble flux.
- Use Sn-3.0Ag-0.5Cu solder.
- Standard thickness of solder paste: 100 μ m to 200 μ m.

11.3 Reflow soldering conditions

- Pre-heating should be in such a way that the temperature difference between solder and product surface is limited to 150°C max. Cooling into solvent after soldering also should be in such a way that the temperature difference is limited to 100°C max.
Insufficient pre-heating may cause cracks on the product, resulting in the deterioration of products quality.
- Standard soldering profile and the limit soldering profile is as follows.
The excessive limit soldering conditions may cause leaching of the electrode and/or resulting in the deterioration of product quality.

Soldering Profile for Lead Free solder

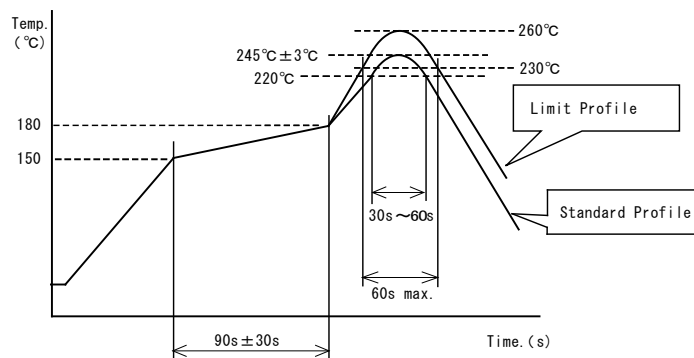

	Standard Profile	Limit Profile
Pre-heating	150°C ~ 180°C, 90s ± 30s	
Heating	above 220°C, 30s ~ 60s	above 230°C, 60s max.
Peak temperature	245°C ± 3°C	260°C, 10s
Cycle of reflow	2 times	

11.4 Reworking with soldering iron

- Pre-heating: 150°C, 1 min □ Soldering iron output: 80W max.
- Tip temperature: 350°C max. □ Tip diameter: φ 3mm max.
- Soldering time : 3(+1,-0) seconds. □ Times : 2times max.

Note :Do not directly touch the products with the tip of the soldering iron in order to prevent the crack on the ferrite material due to the thermal shock.

11.5 Solder Volume

- Solder shall be used not to be exceeded the upper limits as shown below.
- Accordingly increasing the solder volume, the mechanical stress to Chip is also increased. Exceeding solder volume may cause the failure of mechanical or electrical performance.

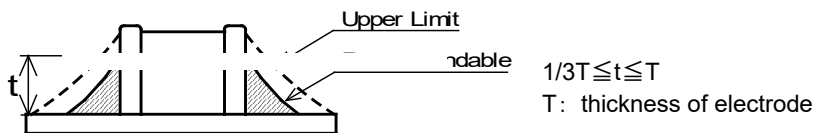

11.6 Product's location

The following shall be considered when designing and laying out P.C.B.'s.

- (1) P.C.B. shall be designed so that products are not subject to the mechanical stress due to warping the board.

[Products direction]

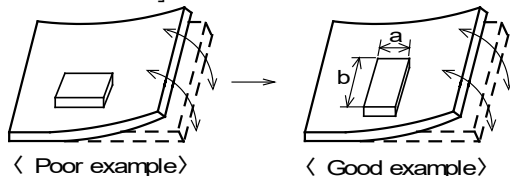

Products shall be located in the sideways direction (Length: a<b) to the mechanical stress.

- (2) Components location on P.C.B. separation.

It is effective to implement the following measures, to reduce stress in separating the board.

It is best to implement all of the following three measures; however, implement as many measures as possible to reduce stress.

Contents of Measures	Stress Level
(1) Turn the mounting direction of the component parallel to the board separation surface.	A > D *1
(2) Add slits in the board separation part.	A > B
(3) Keep the mounting position of the component away from the board separation surface.	A > C

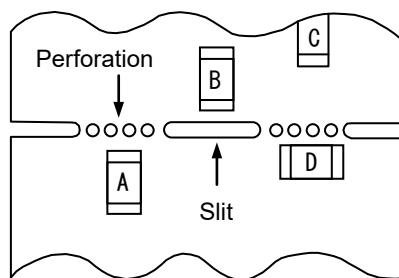

*1 A > D is valid when stress is added vertically to the perforation as with Hand Separation. If a Cutting Disc is used, stress will be diagonal to the PCB, therefore A > D is invalid.

(3) Mounting Components Near Screw Holes

When a component is mounted near a screw hole, it may be affected by the board deflection that occurs during the tightening of the screw. Mount the component in a position as far away from the screw holes as possible.

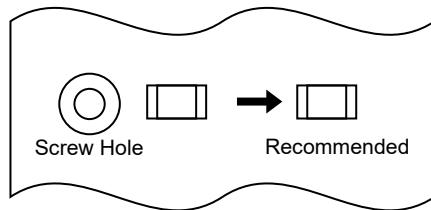
**11.7 Cleaning**

When cleaning this product, observe the following conditions.

Any cleaning may cause deterioration in the quality of the product, so please check the quality of this product before use.

- (1) The cleaning temperature shall be 60°C max. If isopropyl alcohol (IPA) is used, the cleaning temperature shall be 40°C max.
- (2) When ultrasonic cleaning is used, under some cleaning conditions, the substrate could resonate and the substrate vibrations could result in chip cracks, solder breakage, and other problems. Be sure to always perform a test cleaning beforehand using an actual cleaning device, and then check the quality of the products.

(3) Cleaner

Alcohol-based cleaner: IPA

Aqueous agent: PINE ALPHA ST-100S

- (4) There shall be no residual flux or residual cleaner.

When using aqueous agent, rinse the product with deionized water adequately and completely dry it so that no cleaner is left.

* For other cleaning, please consult our technical department.

11.8. Operating Environment

Do not use this product under the following environmental conditions, on deterioration of the Insulation Resistance of the Ferrite material and/or corrosion of Inner Electrode may result from the use.

- (1) In the corrodible atmosphere such as acidic gases, alkaline gases, chlorine, sulfur gases, organic gases and etc. (the sea breeze, Cl₂, H₂S, NH₃, SO₂, NO₂, etc)
- (2) in the atmosphere where liquid such as organic solvent, may splash on the products.
- (3) in the atmosphere where the temperature / humidity changes rapidly and it is easy to dew.

11.9 Resin coating

The impedance value may change and/or it may affect on the product's performance due to high cure-stress of resin to be used for coating/molding products. So please pay your careful attention when you select resin.

In prior to use, please make the reliability evaluation with the product mounted in your application set.

11.10 Caution for use

There is possibility that the impedance value change due to magnetism. Don't use a magnet or a pair of tweezers with magnetism when chip noise filters are handled. (The tip of the tweezers should be molded with resin or pottery.)

11.11 Handling of a substrate

After mounting products on a substrate, do not apply any stress to the product caused by bending or twisting to the substrate when cropping the substrate, inserting and removing a connector from the substrate or tightening screw to the substrate.

Excessive mechanical stress may cause cracking in the product.

Bending

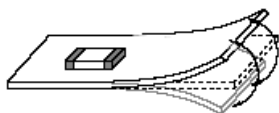

Twisting

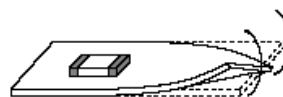

11.12 Storage and Handling Requirements

(1) Storage period

Use the products within 6 months after delivered.
Solderability should be checked if this period is exceeded.

(2) Storage conditions

• Products should be stored in the warehouse on the following conditions.

Temperature : -10°C to 40°C

Humidity : 15% to 85% relative humidity No rapid change on temperature and humidity

Don't keep products in corrosive gases such as sulfur, chlorine gas or acid, or it may cause oxidization of electrode, resulting in poor solderability.

• Products should be stored on the palette for the prevention of the influence from humidity, dust and so on.

• Products should be stored in the warehouse without heat shock, vibration, direct sunlight and so on.

• Avoid storing the product by itself bare (i.e. exposed directly to air).

(3) Handling Condition

Care should be taken when transporting or handling product to avoid excessive vibration or mechanical shock.

12.  Note

(1) Please make sure that your product has been evaluated in view of your specifications with our product being mounted to your product.



(2) You are requested not to use our product deviating from the reference specifications.

(3) The contents of this reference specification are subject to change without advance notice.

Please approve our product specifications or transact the approval sheet for product specifications before ordering.

Looking for pricing, stock, or lifecycle information?

Click below to explore more details on WIN SOURCE:

-  [View NFZ15SG262SN10D on WIN SOURCE](#)
-  [Murata Electronics North America Information](#)

Optimize Your Supply Chain with WIN SOURCE Solutions

-  Global Sourcing Solution
-  Obsolete Management
-  Cost Control Management
-  Shortage Management
-  Alternative Solution
-  Excess Inventory Management