



**THE DATASHEET OF
APT75DQ120BG**



APT75DQ120BG
Datasheet
Ultrafast Soft Recovery Rectifier Diode

Final
October 2018



Contents

1	Revision History	1
1.1	Revision E	1
1.2	Revision D	1
1.3	Revision C	1
1.4	Revision B	1
1.5	Revision A	1
2	Product Overview	2
2.1	Features	2
2.2	Benefits	2
2.3	Applications	2
3	Electrical Specifications	3
3.1	Absolute Maximum Ratings	3
3.2	Electrical Performance	3
3.3	Dynamic Characteristics	4
3.4	Typical Performance Curves	5
3.5	Reverse Recovery Overview	8
4	Package Specification	9
4.1	Package Outline Drawing	9

1 Revision History

The revision history describes the changes that were implemented in the document. The changes are listed by revision, starting with the most current publication.

1.1 Revision E

Revision E was published in October 2018. In this revision, the new template and format was applied. The following is a summary of changes in the revision E of this document.

- Product image was updated.
- Product features were updated. For more information, see [Product Overview \(see page 2\)](#).
- The lead thickness in the package outline drawing was updated. For more information, see [Package Outline Drawing \(see page 9\)](#).

1.2 Revision D

Revision D was published in June 2011. In this revision, forward voltage maximum was changed from 3.1 V to 3.3 V.

1.3 Revision C

Revision C was published in May 2011. The following is a summary of the changes in revision C of this document.

- Removed patent information.
- Changed maximum lead thickness from 0.79 mm (0.031 in.) to 1.016 mm (0.040 in.).

1.4 Revision B

Revision B was published in August 2005. In this revision, the I_{RM} was changed to 100 μ A.

1.5 Revision A

Revision A was published in June 2005. It is the first publication of this document.

2 Product Overview

This section outlines the product overview for the APT75DQ120BG device.

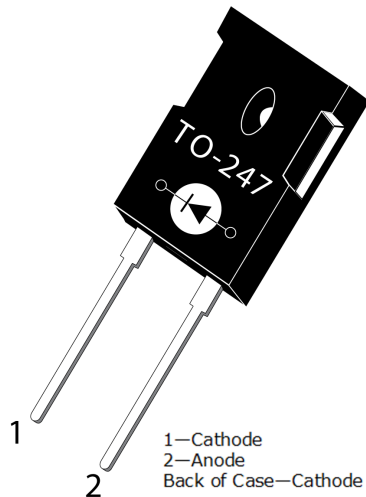

2.1 Features

The following are key features of the APT75DQ120BG device:

- Ultrafast recovery times
- Soft recovery characteristics
- Low forward voltage
- Low leakage current
- Avalanche energy rated
- RoHS compliant
- AEC-Q101 qualified

2.2 Benefits

The following are benefits of the APT75DQ120BG device:

- High switching frequency
- Low switching losses
- Low noise (EMI) switching
- Higher reliability systems
- Increased system power density

2.3 Applications

The APT75DQ120BG device is designed for the following applications:

- Power factor correction (PFC)
- Anti-parallel diode
 - Switch-mode power supply
 - Inverters/converters
 - Motor controllers
- Freewheeling diode
 - Switch-mode power supply
 - Inverters/converters
- Snubber/clamp diode

3 Electrical Specifications

This section shows the electrical specifications for the APT75DQ120BG device.

3.1 Absolute Maximum Ratings

The following table shows the absolute maximum ratings for the APT75DQ120BG device.

All ratings: $T_c = 25\text{ }^\circ\text{C}$ unless otherwise specified.

Table 1 • Absolute Maximum Ratings

Symbol	Parameter	Ratings	Unit
V_R	Maximum DC reverse voltage	1200	V
V_{RRM}	Maximum peak repetitive reverse voltage	1200	
V_{RWM}	Maximum working peak reverse voltage	1200	
$I_{F(AV)}$	Maximum average forward current ($T_c = 112\text{ }^\circ\text{C}$, duty cycle = 0.5)	75	A
$I_{F(RMS)}$	RMS forward current	121	
I_{FSM}	Non-repetitive forward surge current ($T_J = 45\text{ }^\circ\text{C}$, 8.3 ms)	540	
E_{AVL}	Avalanche energy (1 A, 40 mH)	20	mJ
T_J, T_{STG}	Operating and storage temperature range	-55 to 175	$^\circ\text{C}$
T_L	Lead temperature for 10 seconds	300	

The following table shows the thermal and mechanical characteristics of the APT75DQ120BG device.

Table 2 • Thermal and Mechanical Characteristics

Symbol	Characteristic	Min	Typ	Max	Unit
$R_{\theta JC}$	Junction-to-case thermal resistance			0.31	$^\circ\text{C}/\text{W}$
Wt	Package weight		0.22		oz
			6.2		g
	Maximum mounting torque			10	lbf-in
				1.1	N-m

3.2 Electrical Performance

The following table shows the static characteristics of the APT75DQ120BG device.

Table 3 • Static Characteristics

Symbol	Characteristic	Test Conditions	Min	Typ	Max	Unit
V_F	Forward voltage	$I_F = 75\text{ A}$		2.8	3.3	V
		$I_F = 150\text{ A}$		3.5		
		$I_F = 75\text{ A}, T_J = 125\text{ }^\circ\text{C}$		2.2		
I_{RM}	Maximum reverse leakage current	$V_R = 1200\text{ V}$			100	μA
		$V_R = 1200\text{ V}, T_J = 125\text{ }^\circ\text{C}$			500	
C_J	Junction capacitance	$V_R = 200\text{ V}$		50		pF

3.3 Dynamic Characteristics

The following table shows the dynamic characteristics of the APT75DQ120BG device.

Table 4 • Dynamic Characteristics

Symbol	Characteristic	Test Conditions	Min	Typ	Max	Unit
t_{rr}	Reverse recovery time	$I_F = 1\text{ A}$ $di_F/dt = -100\text{ A}/\mu\text{s}$ $V_R = 30\text{ V}$ $T_J = 25\text{ }^\circ\text{C}$		32		ns
t_{rr}	Reverse recovery time	$I_F = 75\text{ A}$		325		
Q_{rr}	Reverse recovery charge	$di_F/dt = -200\text{ A}/\mu\text{s}$ $V_R = 800\text{ V}$		715		nC
I_{RRM}	Maximum reverse recovery current	$T_C = 25\text{ }^\circ\text{C}$		5		A
t_{rr}	Reverse recovery time	$I_F = 75\text{ A}$		420		ns
Q_{rr}	Reverse recovery charge	$di_F/dt = -200\text{ A}/\mu\text{s}$ $V_R = 800\text{ V}$		3340		nC
I_{RRM}	Maximum reverse recovery current	$T_C = 125\text{ }^\circ\text{C}$		13		A
t_{rr}	Reverse recovery time	$I_F = 75\text{ A}$		195		ns
Q_{rr}	Reverse recovery charge	$di_F/dt = -1000\text{ A}/\mu\text{s}$ $V_R = 800\text{ V}$		5810		nC
I_{RRM}	Maximum reverse recovery current	$T_C = 125\text{ }^\circ\text{C}$		42		A

3.4 Typical Performance Curves

This section shows the typical performance curves for the APT75DQ120BG device.

Figure 1 • Maximum Transient Thermal Impedance

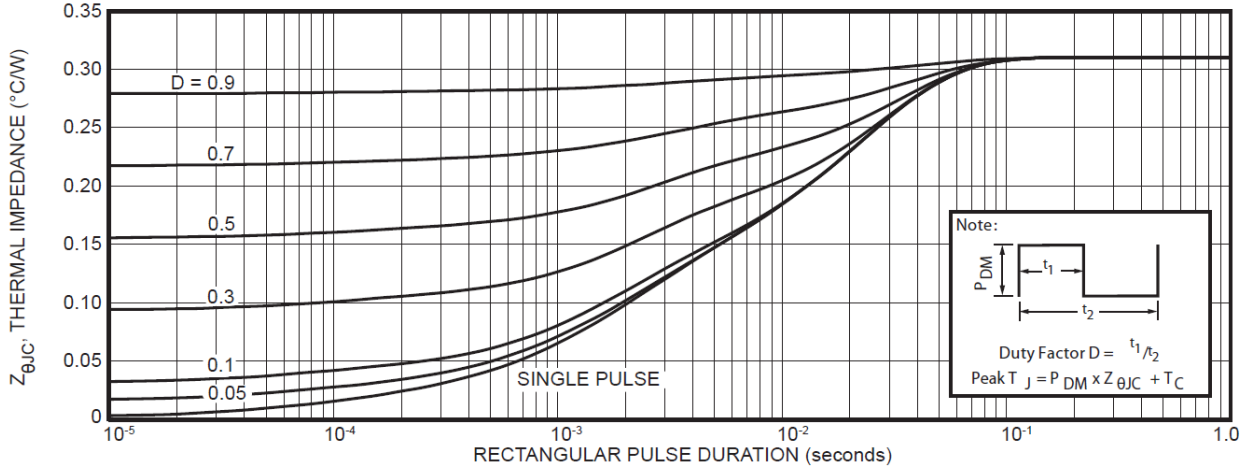

Figure 2 • Forward Current vs. Forward Voltage

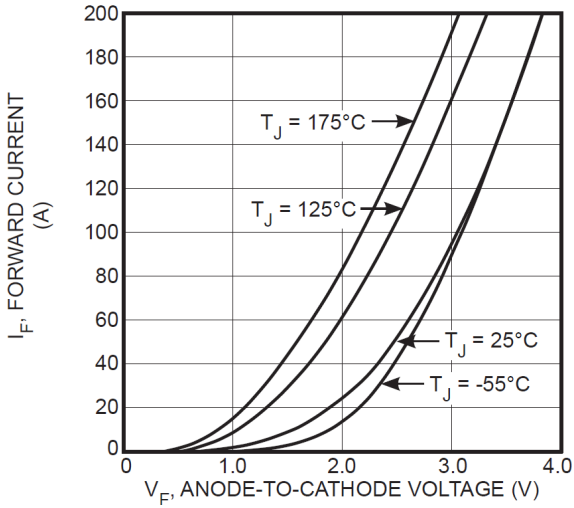

Figure 3 • RRT vs. Current Rate of Change

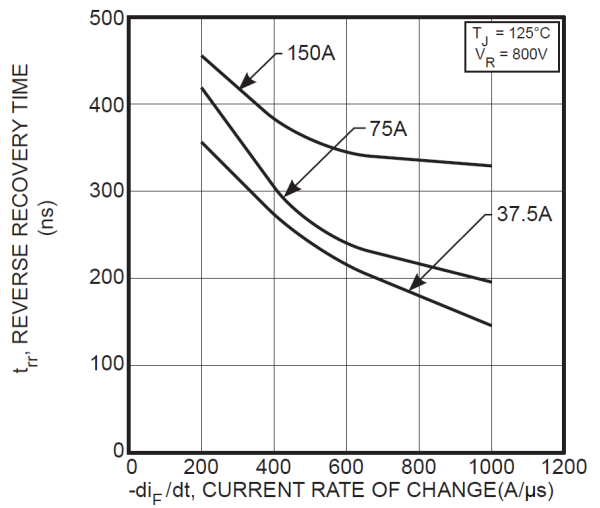

Figure 4 • Reverse Recovery Charge vs. Current Rate of Change

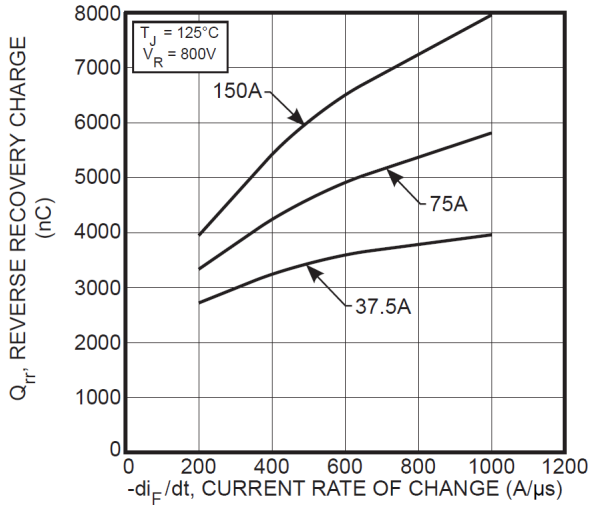

Figure 5 • Reverse Recovery Current vs. Current Rate of Change

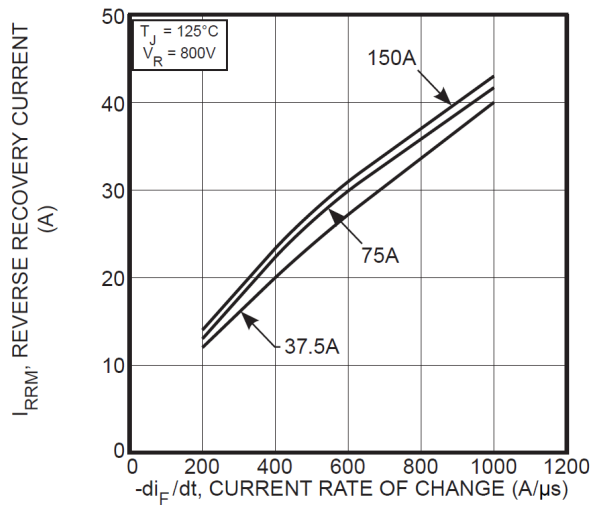

Figure 6 • Dynamic Parameters vs. Junction Temperature

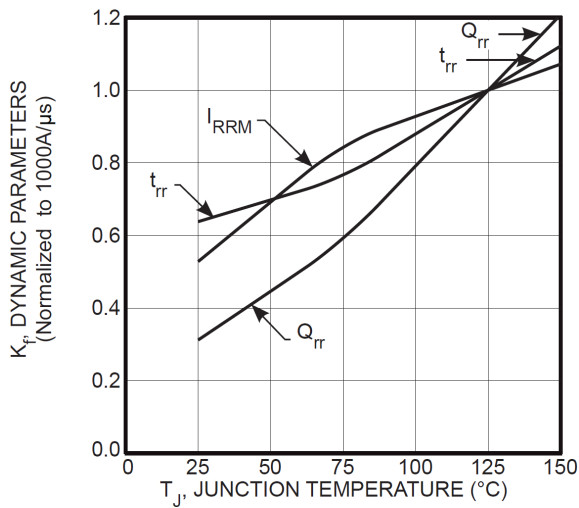

Figure 7 • Maximum Average Forward Current vs. Case Temperature

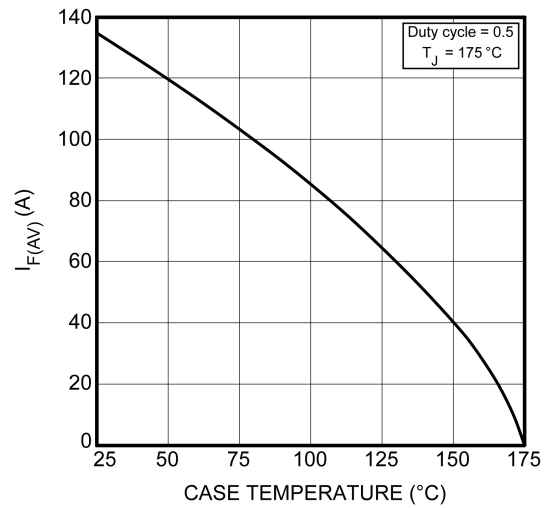
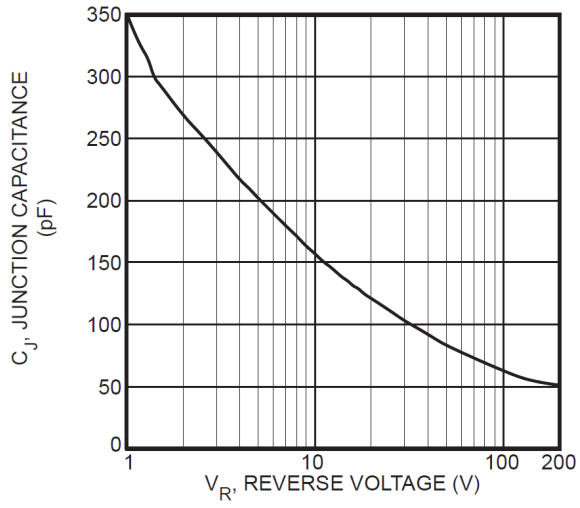

Figure 8 • Junction Capacitance vs. Reverse Voltage



3.5 Reverse Recovery Overview

The following illustration shows the diode test circuit for the APT75DQ120BG device.

Figure 9 • Diode Test Circuit

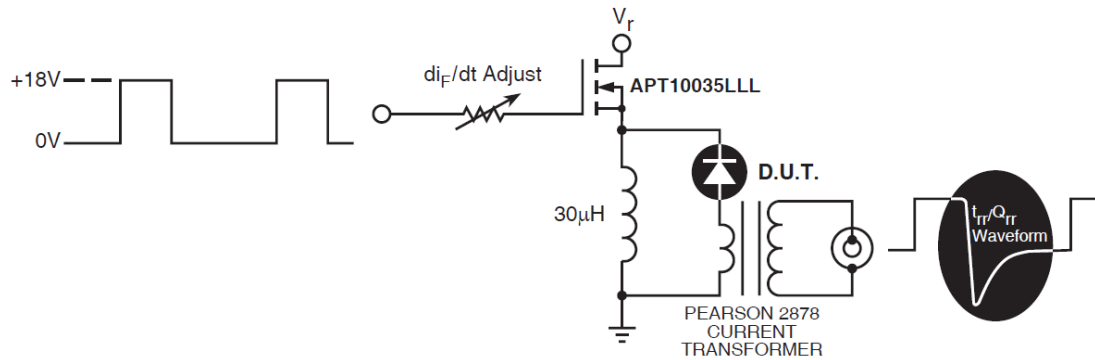

The following illustration shows the diode reverse recovery waveform and definitions for the APT75DQ120BG device.

Figure 10 • Diode Reverse Recovery Waveform and Definitions

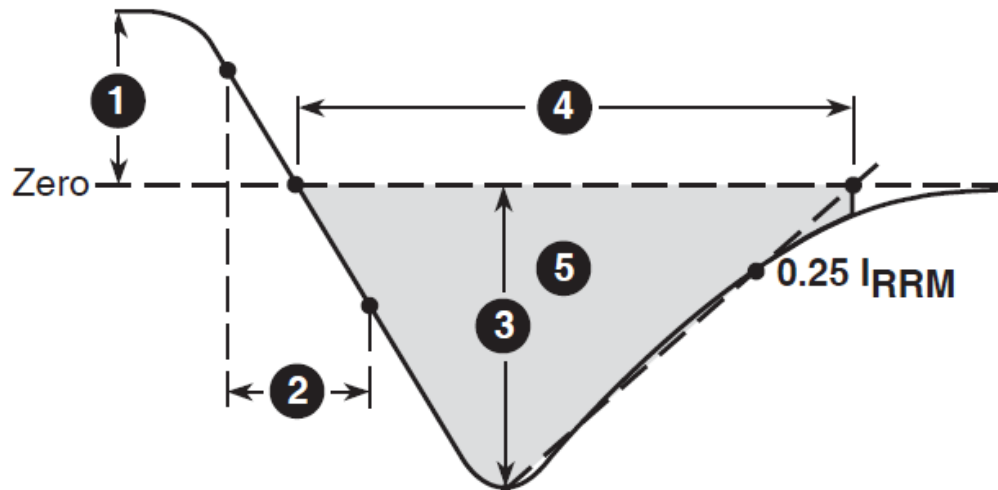

1. I_F —Forward conduction current.
2. di_F/dt —Rate of diode current change through zero crossing.
3. I_{RRM} —Maximum reverse recovery current.
4. t_{rr} —Reverse recovery time, measured from zero crossing where diode current goes from positive to negative, to the point at which the straight line through I_{RRM} and $0.25 \cdot I_{RRM}$ passes through zero.
5. Q_{rr} —Area under the curve defined by I_{RRM} and t_{rr} .

4 Package Specification

This section shows the package specification for the APT75DQ120BG device.

4.1 Package Outline Drawing

This section shows the TO-247 package drawing of the APT75DQ120BG device. Dimensions are in millimeters and (inches).

Figure 11 • Package Outline Drawing

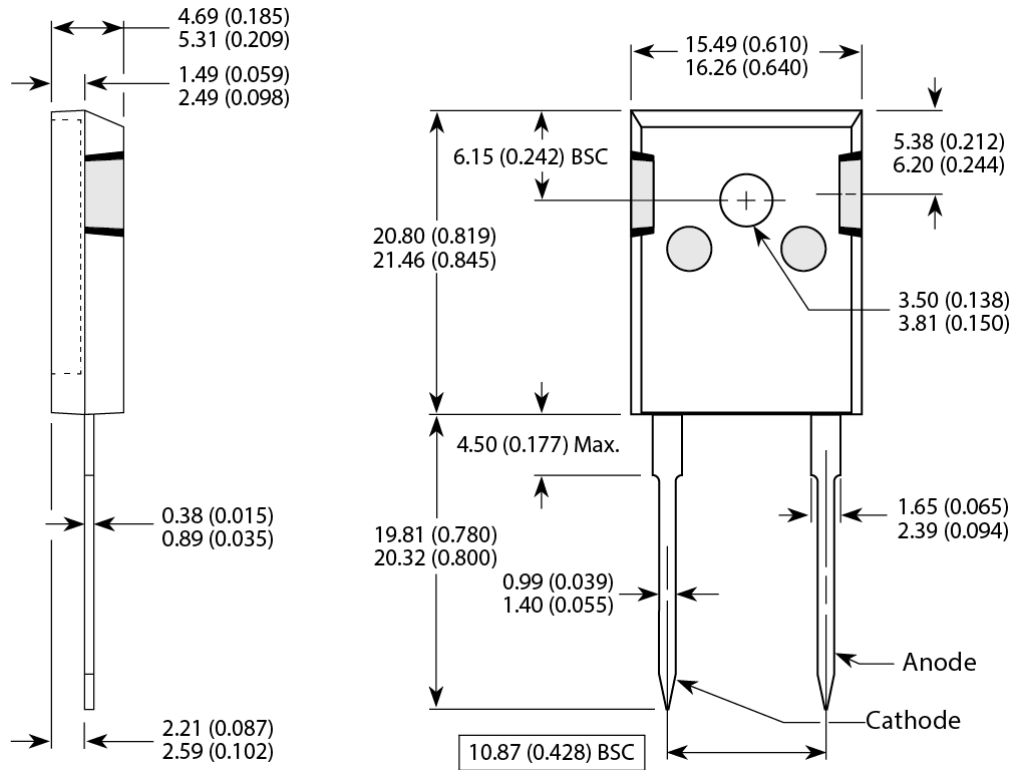

**Microsemi Headquarters**

One Enterprise, Aliso Viejo,
CA 92656 USA
Within the USA: +1 (800) 713-4113
Outside the USA: +1 (949) 380-6100
Sales: +1 (949) 380-6136
Fax: +1 (949) 215-4996
Email: sales.support@microsemi.com
www.microsemi.com

© 2018 Microsemi. All rights reserved. Microsemi and the Microsemi logo are trademarks of Microsemi Corporation. All other trademarks and service marks are the property of their respective owners.



Microsemi makes no warranty, representation, or guarantee regarding the information contained herein or the suitability of its products and services for any particular purpose, nor does Microsemi assume any liability whatsoever arising out of the application or use of any product or circuit. The products sold hereunder and any other products sold by Microsemi have been subject to limited testing and should not be used in conjunction with mission-critical equipment or applications. Any performance specifications are believed to be reliable but are not verified, and Buyer must conduct and complete all performance and other testing of the products, alone and together with, or installed in, any end-products. Buyer shall not rely on any data and performance specifications or parameters provided by Microsemi. It is the Buyer's responsibility to independently determine suitability of any products and to test and verify the same. The information provided by Microsemi hereunder is provided "as is, where is" and with all faults, and the entire risk associated with such information is entirely with the Buyer. Microsemi does not grant, explicitly or implicitly, to any party any patent rights, licenses, or any other IP rights, whether with regard to such information itself or anything described by such information. Information provided in this document is proprietary to Microsemi, and Microsemi reserves the right to make any changes to the information in this document or to any products and services at any time without notice.

Microsemi, a wholly owned subsidiary of Microchip Technology Inc. (Nasdaq: MCHP), offers a comprehensive portfolio of semiconductor and system solutions for aerospace & defense, communications, data center and industrial markets. Products include high-performance and radiation-hardened analog mixed-signal integrated circuits, FPGAs, SoCs and ASICs; power management products; timing and synchronization devices and precise time solutions; setting the world's standard for time; voice processing devices; RF solutions; discrete components; enterprise storage and communication solutions; security technologies and scalable anti-tamper products; Ethernet solutions; Power-over-Ethernet ICs and midspans; as well as custom design capabilities and services. Microsemi is headquartered in Aliso Viejo, California, and has approximately 4,800 employees globally. Learn more at www.microsemi.com.

053-4229

Looking for pricing, stock, or lifecycle information?

Click below to explore more details on WIN SOURCE:

-  [View APT75DQ120BG on WIN SOURCE](#)
-  [Microsemi Corporation](#) Information

Optimize Your Supply Chain with WIN SOURCE Solutions

-  Global Sourcing Solution
-  Obsolete Management
-  Cost Control Management
-  Shortage Management
-  Alternative Solution
-  Excess Inventory Management