

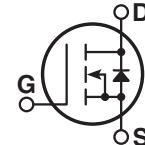

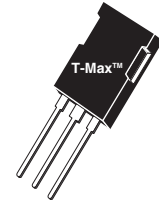

## Super Junction MOSFET



- Ultra Low  $R_{DS(ON)}$
- Low Miller Capacitance
- Ultra Low Gate Charge,  $Q_g$
- Avalanche Energy Rated
- Extreme  $dv/dt$  Rated
- Dual die (parallel)
- Popular T-MAX Package

Unless stated otherwise, Microsemi discrete MOSFETs contain a single MOSFET die. This device is made with two parallel MOSFET die. It is intended for switch-mode operation. It is not suitable for linear mode operation.

### MAXIMUM RATINGS

All Ratings per die:  $T_C = 25^\circ\text{C}$  unless otherwise specified.

Symbol	Parameter	APT94N65B2C3G	UNIT
$V_{DSS}$	Drain-Source Voltage	650	Volts
$I_D$	Continuous Drain Current @ $T_C = 25^\circ\text{C}$ ①	94	Amps
	Continuous Drain Current @ $T_C = 100^\circ\text{C}$	60	
$I_{DM}$	Pulsed Drain Current ②	282	
$V_{GS}$	Gate-Source Voltage Continuous	20	Volts
$P_D$	Total Power Dissipation @ $T_C = 25^\circ\text{C}$	833	Watts
$T_J, T_{STG}$	Operating and Storage Junction Temperature Range	-55 to 150	$^\circ\text{C}$
$T_L$	Lead Temperature: 0.063" from Case for 10 Sec.	260	
$dv/dt$	Drain-Source Voltage slope ( $V_{DS} = 480\text{V}$ , $I_D = 94\text{A}$ , $T_J = 125^\circ\text{C}$ )	50	V/ns
$I_{AR}$	Avalanche Current ②	7	Amps
$E_{AR}$	Repetitive Avalanche Energy ③ ( $I_D = 3.5\text{A}$ , $V_{DD} = 50\text{V}$ )	1	mJ
$E_{AS}$	Single Pulse Avalanche Energy ( $I_D = 3.5\text{A}$ , $V_{DD} = 50\text{V}$ )	1800	

### STATIC ELECTRICAL CHARACTERISTICS

Symbol	Characteristic / Test Conditions	MIN	TYP	MAX	UNIT
$BV_{(DSS)}$	Drain-Source Breakdown Voltage ( $V_{GS} = 0\text{V}$ , $I_D = 500\mu\text{A}$ )	650			Volts
$R_{DS(on)}$	Drain-Source On-State Resistance ③ ( $V_{GS} = 10\text{V}$ , $I_D = 47\text{A}$ )		0.03	0.035	Ohms
$I_{DSS}$	Zero Gate Voltage Drain Current ( $V_{DS} = 650\text{V}$ , $V_{GS} = 0\text{V}$ )		1.0	50	$\mu\text{A}$
	Zero Gate Voltage Drain Current ( $V_{DS} = 650\text{V}$ , $V_{GS} = 0\text{V}$ , $T_C = 150^\circ\text{C}$ )		100		
$I_{GSS}$	Gate-Source Leakage Current ( $V_{GS} = \pm 20\text{V}$ , $V_{DS} = 0\text{V}$ )			$\pm 200$	nA
$V_{GS(th)}$	Gate Threshold Voltage ( $V_{DS} = V_{GS}$ , $I_D = 5.8\text{mA}$ )	2.1	3	3.9	Volts

 CAUTION: These Devices are Sensitive to Electrostatic Discharge. Proper Handling Procedures Should Be Followed.

"COOLMOS™" comprise a new family of transistors developed by Infineon Technologies AG. "COOLMOS" is a trademark of Infineon Technologies AG."

Microsemi Website - <http://www.microsemi.com>

**DYNAMIC CHARACTERISTICS**

**APT94N65B2C3G**

Symbol	Characteristic	Test Conditions	MIN	TYP	MAX	UNIT
$C_{iss}$	Input Capacitance	$V_{GS} = 0V$ $V_{DS} = 25V$ $f = 1\text{ MHz}$		13940		pF
$C_{oss}$	Output Capacitance			5200		
$C_{rss}$	Reverse Transfer Capacitance			229		
$Q_g$	Total Gate Charge <sup>④</sup>	$V_{GS} = 10V$ $V_{DD} = 300V$ $I_D = 94A @ 25^\circ C$		580		nC
$Q_{gs}$	Gate-Source Charge			72		
$Q_{gd}$	Gate-Drain ("Miller") Charge			234		
$t_{d(on)}$	Turn-on Delay Time	<b>INDUCTIVE SWITCHING</b> $V_{GS} = 15V$ $V_{DD} = 400V$ $I_D = 94A @ 25^\circ C$ $R_G = 4.3\Omega$		32		ns
$t_r$	Rise Time			59		
$t_{d(off)}$	Turn-off Delay Time			498		
$t_f$	Fall Time			167		
$E_{on}$	Turn-on Switching Energy <sup>⑤</sup>	<b>INDUCTIVE SWITCHING @ 25°C</b> $V_{DD} = 400V, V_{GS} = 15V$ $I_D = 94A, R_G = 4.3\Omega$		2684		$\mu J$
$E_{off}$	Turn-off Switching Energy			4448		
$E_{on}$	Turn-on Switching Energy <sup>⑤</sup>	<b>INDUCTIVE SWITCHING @ 125°C</b> $V_{DD} = 400V, V_{GS} = 15V$ $I_D = 94A, R_G = 4.3\Omega$		3391		
$E_{off}$	Turn-off Switching Energy			5082		

**SOURCE-DRAIN DIODE RATINGS AND CHARACTERISTICS**

Symbol	Characteristic / Test Conditions	MIN	TYP	MAX	UNIT
$I_s$	Continuous Source Current (Body Diode)			94	Amps
$I_{SM}$	Pulsed Source Current <sup>②</sup> (Body Diode)			282	
$V_{SD}$	Diode Forward Voltage <sup>④</sup> ( $V_{GS} = 0V, I_s = -94A$ )		0.9	1.2	Volts
$t_{rr}$	Reverse Recovery Time ( $I_s = -94A, di/dt = 100A/\mu s$ )	$T_j = 25^\circ C$		960	ns
				1271	
$Q_{rr}$	Reverse Recovery Charge ( $I_s = -94A, di/dt = 100A/\mu s$ )	$T_j = 25^\circ C$		31	$\mu C$
				43	
$I_{RRM}$	Peak Recovery Current ( $I_s = -94A, di/dt = 100A/\mu s$ )	$T_j = 25^\circ C$		58	Amps
				56	

**THERMAL CHARACTERISTICS**

Symbol	Characteristic	MIN	TYP	MAX	UNIT
$R_{\theta JC}$	Junction to Case			0.15	$^\circ C/W$
$R_{\theta JA}$	Junction to Ambient			31	

- ① Repetitive Rating: Pulse width limited by maximum junction temperature.
- ② Repetitive avalanche causes additional power losses that can be calculated as  $P_{AV} = E_{AR} * f$ . **Pulse width tp limited by Tj max.**
- ③ Pulse Test: Pulse width < 380  $\mu s$ , Duty Cycle < 2%
- ④ See MIL-STD-750 Method 3471
- ⑤ Eon includes diode reverse recovery.
- ⑥ Maximum 125°C diode commutation speed = di/dt 600A/ $\mu s$

Microsemi reserves the right to change, without notice, the specifications and information contained herein.

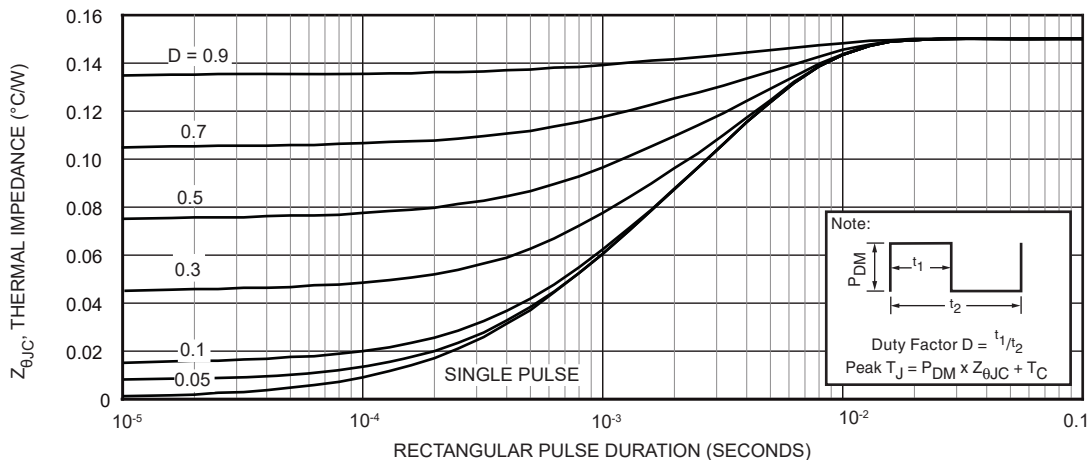

Figure 1, Maximum Effective Transient Thermal Impedance, Junction-To-Case vs Pulse Duration

# Typical Performance Curves

APT94N65B2C3G

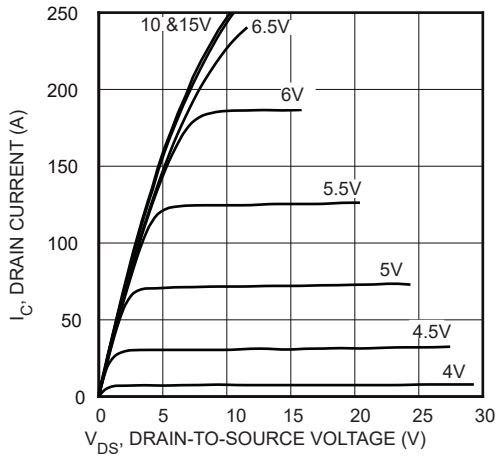

FIGURE 2, Low Voltage Output Characteristics

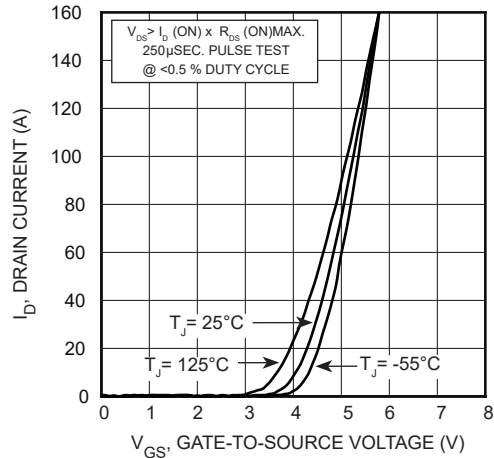

FIGURE 3, Transfer Characteristics

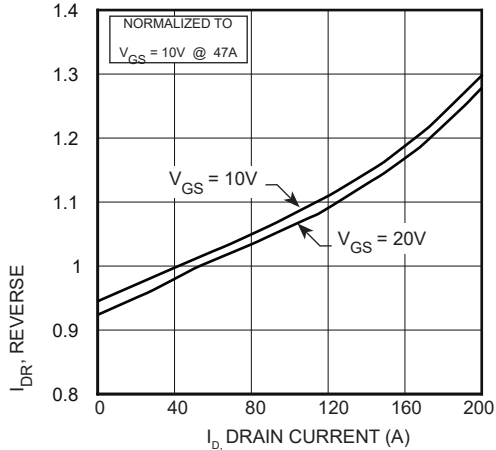

FIGURE 4,  $R_{DS(ON)}$  vs Drain Current

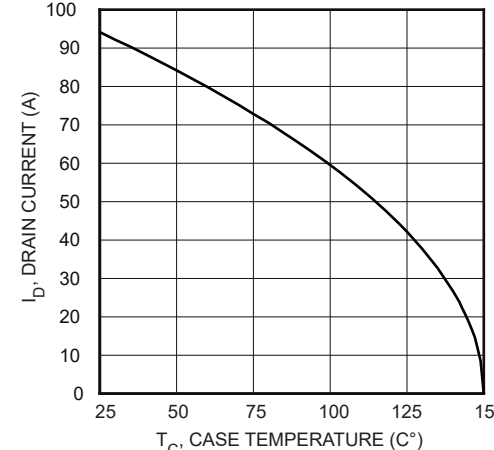

FIGURE 5, Maximum Drain Current vs Case Temperature

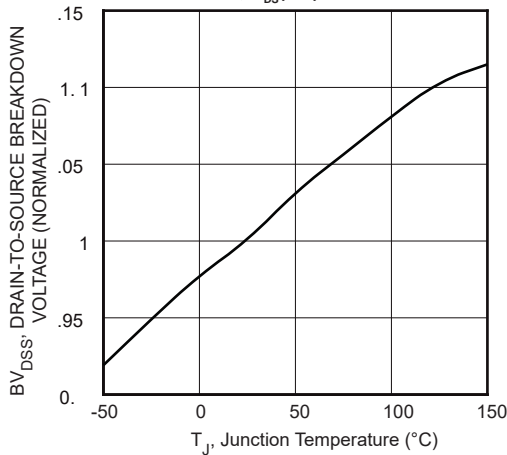

FIGURE 6, Breakdown Voltage vs Temperature

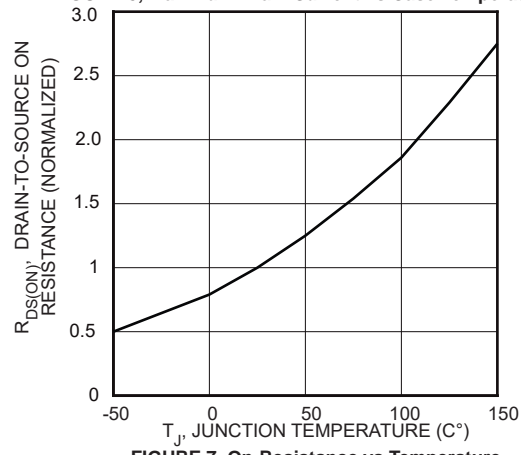

FIGURE 7, On-Resistance vs Temperature

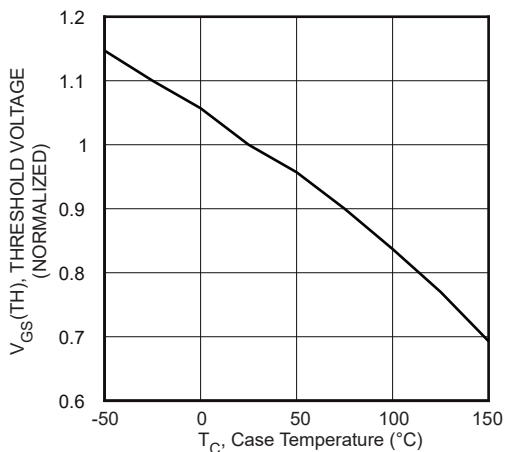

FIGURE 8, Threshold Voltage vs Temperature

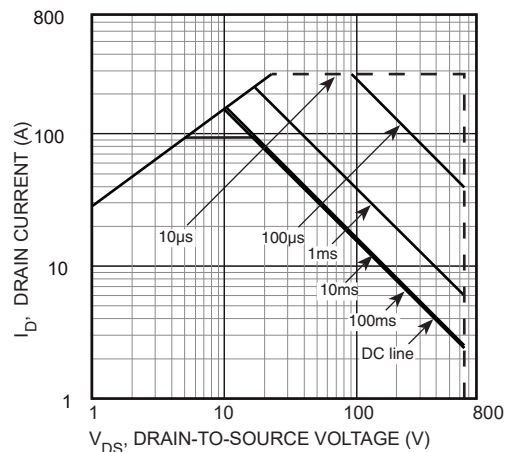

FIGURE 9, Maximum Safe Operating Area

# Typical Performance Curves

APT94N65B2C3G

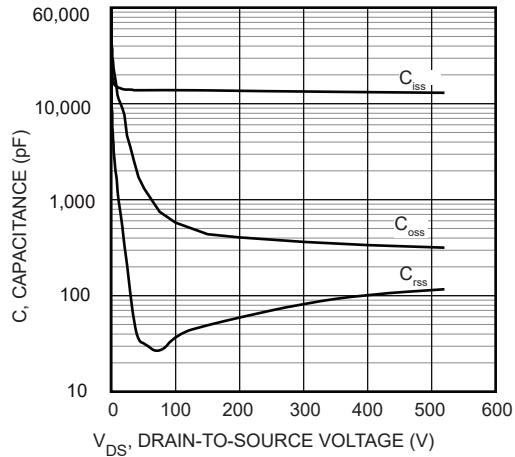

FIGURE 10, Capacitance vs Drain-To-Source Voltage

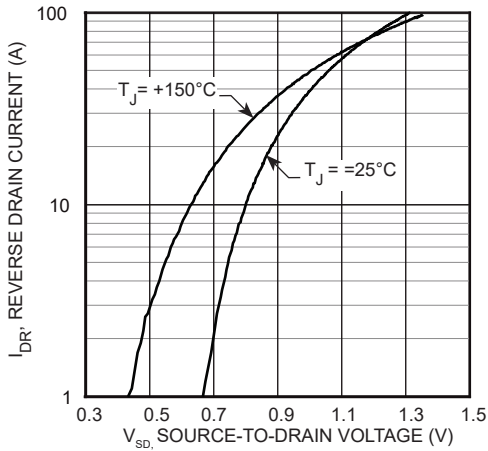

FIGURE 12, Source-Drain Diode Forward Voltage

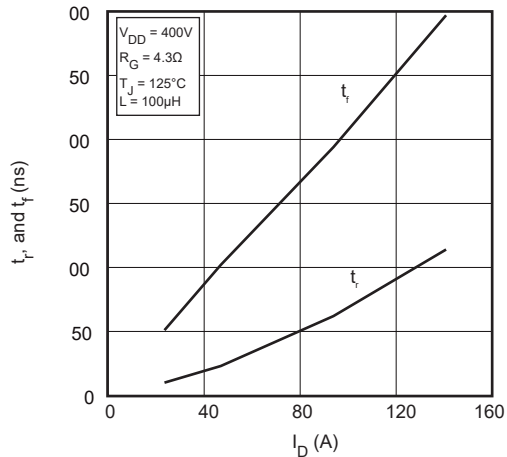

FIGURE 14, Rise and Fall Times vs Current

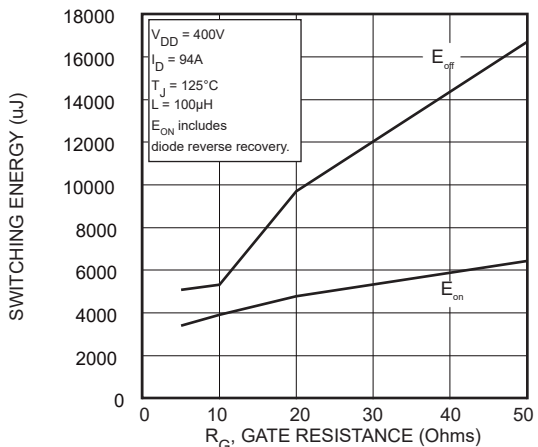

FIGURE 16, Switching Energy vs Gate Resistance

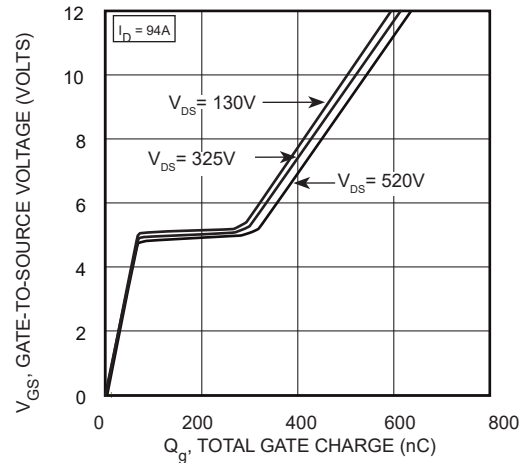

FIGURE 11, Gate Charges vs Gate-To-Source Voltage

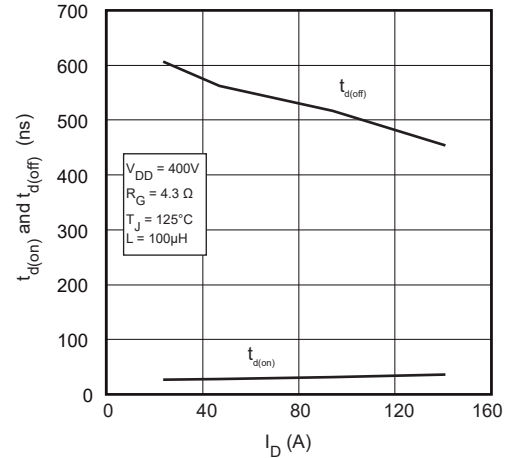

FIGURE 13, Delay Times vs Current

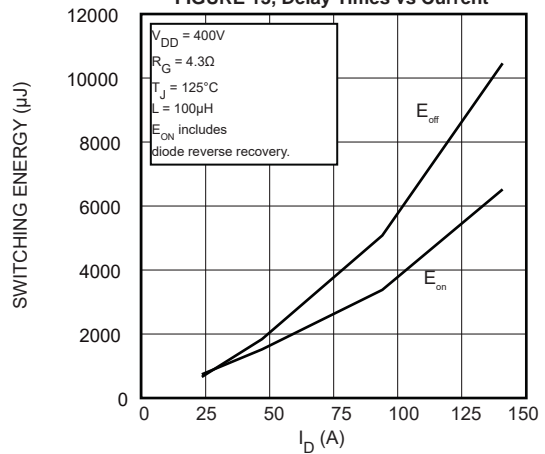

FIGURE 15, Switching Energy vs Current

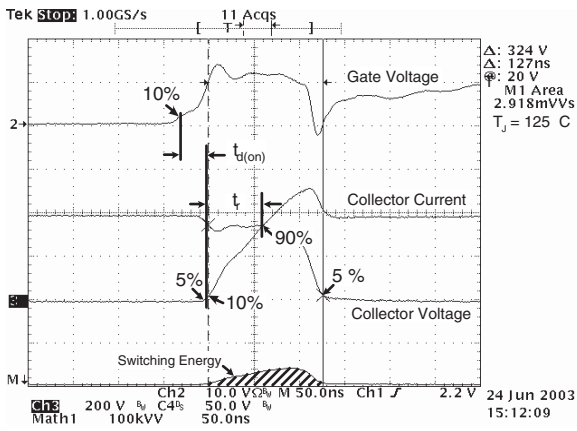

Figure 17, Turn-on Switching Waveforms and Definitions

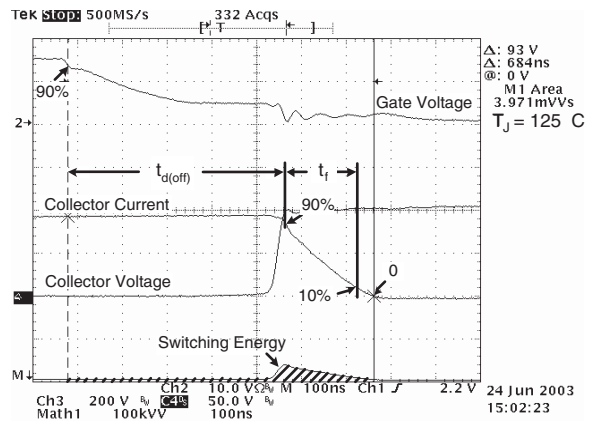

Figure 18, Turn-off Switching Waveforms and Definitions

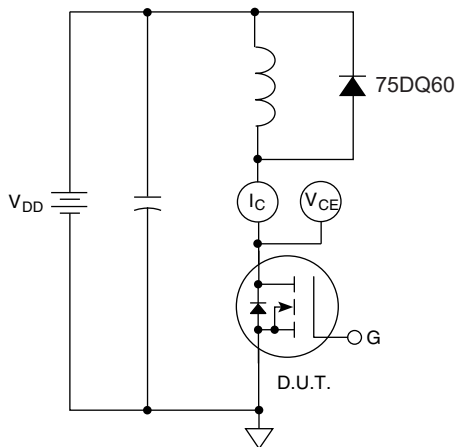
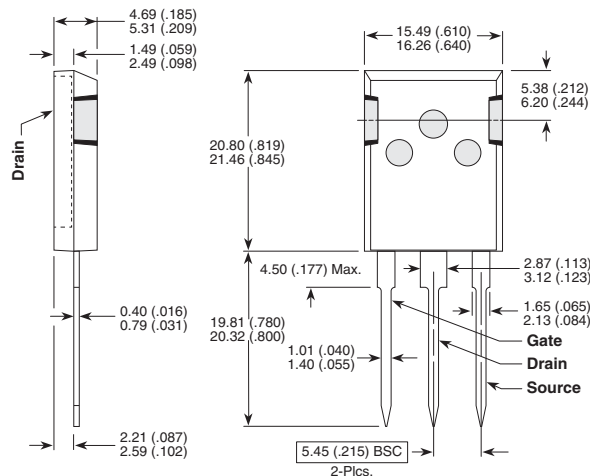

Figure 19, Inductive Switching Test Circuit

### T-MAX® (B2) Package Outline

Ⓢ SAC: Tin, Silver, Copper



These dimensions are equal to the TO-247 without the mounting hole.  
Dimensions in Millimeters and (Inches)

## Looking for pricing, stock, or lifecycle information?

Click below to explore more details on WIN SOURCE:

 [View APT94N65B2C3G on WIN SOURCE](#)

 [Microsemi Corporation](#) Information

## Optimize Your Supply Chain with WIN SOURCE Solutions

-  Global Sourcing Solution
-  Obsolete Management
-  Cost Control Management
-  Shortage Management
-  Alternative Solution
-  Excess Inventory Management