

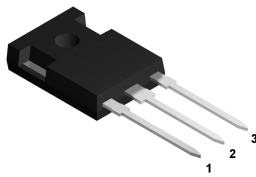

# THE DATASHEET OF STGW40H65DFB



## Trench gate field-stop 650 V, 40 A high speed HB series IGBT



TO-247 long leads

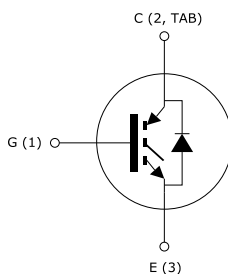

## Features

- Maximum junction temperature:  $T_J = 175\text{ }^\circ\text{C}$
- High speed switching series
- Minimized tail current
- Low saturation voltage:  $V_{CE(sat)} = 1.6\text{ V (typ.) @ } I_C = 40\text{ A}$
- Tight parameter distribution
- Safe paralleling
- Positive  $V_{CE(sat)}$  temperature coefficient
- Low thermal resistance
- Very fast soft recovery antiparallel diode

## Applications

- Photovoltaic inverters
- High frequency converters

## Description

This device is an IGBT developed using an advanced proprietary trench gate field-stop structure. The device is part of the new HB series of IGBTs, which represents an optimum compromise between conduction and switching loss to maximize the efficiency of any frequency converter. Furthermore, the slightly positive  $V_{CE(sat)}$  temperature coefficient and very tight parameter distribution result in safer paralleling operation.

## Product status link

[STGWA40H65DFB](#)

## Product summary

Order code	STGWA40H65DFB
Marking	G40H65DFB
Package	TO-247 long leads
Packing	Tube

# 1 Electrical ratings

**Table 1. Absolute maximum ratings**

Symbol	Parameter	Value	Unit
$V_{CES}$	Collector-emitter voltage ( $V_{GE} = 0$ V)	650	V
$I_C$	Continuous collector current at $T_C = 25$ °C	80	A
	Continuous collector current at $T_C = 100$ °C	40	
$I_{CP}^{(1)}$	Pulsed collector current	160	A
$V_{GE}$	Gate-emitter voltage	$\pm 20$	V
	Transient gate-emitter voltage	$\pm 30$	
$I_F$	Continuous forward current at $T_C = 25$ °C	80	A
	Continuous forward current at $T_C = 100$ °C	40	
$I_{FP}^{(1)}$	Pulsed forward current	160	A
$P_{TOT}$	Total power dissipation at $T_C = 25$ °C	283	W
$T_{STG}$	Storage temperature range	- 55 to 150	°C
$T_J$	Operating junction temperature range	- 55 to 175	

1. Pulse width limited by maximum junction temperature.

**Table 2. Thermal data**

Symbol	Parameter	Value	Unit
$R_{thJC}$	Thermal resistance junction-case IGBT	0.53	°C/W
$R_{thJC}$	Thermal resistance junction-case diode	1.14	
$R_{thJA}$	Thermal resistance junction-ambient	50	

## 2 Electrical characteristics

$T_C = 25\text{ °C}$  unless otherwise specified

**Table 3. Static characteristics**

Symbol	Parameter	Test conditions	Min.	Typ.	Max.	Unit
$V_{(BR)CES}$	Collector-emitter breakdown voltage	$V_{GE} = 0\text{ V}$ , $I_C = 2\text{ mA}$	650			V
$V_{CE(sat)}$	Collector-emitter saturation voltage	$V_{GE} = 15\text{ V}$ , $I_C = 40\text{ A}$		1.6	2	V
		$V_{GE} = 15\text{ V}$ , $I_C = 40\text{ A}$ , $T_J = 125\text{ °C}$		1.7		
		$V_{GE} = 15\text{ V}$ , $I_C = 40\text{ A}$ , $T_J = 175\text{ °C}$		1.8		
$V_F$	Forward on-voltage	$I_F = 40\text{ A}$		1.7	2.45	V
		$I_F = 40\text{ A}$ , $T_J = 125\text{ °C}$		1.4		
		$I_F = 40\text{ A}$ , $T_J = 175\text{ °C}$		1.3		
$V_{GE(th)}$	Gate threshold voltage	$V_{CE} = V_{GE}$ , $I_C = 1\text{ mA}$	5	6	7	V
$I_{CES}$	Collector cut-off current	$V_{GE} = 0\text{ V}$ , $V_{CE} = 650\text{ V}$			25	$\mu\text{A}$
$I_{GES}$	Gate-emitter leakage current	$V_{CE} = 0\text{ V}$ , $V_{GE} = \pm 20\text{ V}$			$\pm 250$	nA

**Table 4. Dynamic characteristics**

Symbol	Parameter	Test conditions	Min.	Typ.	Max.	Unit
$C_{ies}$	Input capacitance	$V_{CE} = 25\text{ V}$ , $f = 1\text{ MHz}$ , $V_{GE} = 0\text{ V}$	-	5412	-	pF
$C_{oes}$	Output capacitance		-	198	-	
$C_{res}$	Reverse transfer capacitance		-	107	-	
$Q_g$	Total gate charge	$V_{CC} = 520\text{ V}$ , $I_C = 40\text{ A}$ , $V_{GE} = 0\text{ to }15\text{ V}$ (see Figure 28. Gate charge test circuit)	-	210	-	nC
$Q_{ge}$	Gate-emitter charge		-	39	-	
$Q_{gc}$	Gate-collector charge		-	82	-	

**Table 5. IGBT switching characteristics (inductive load)**

Symbol	Parameter	Test conditions	Min.	Typ.	Max.	Unit	
$t_{d(on)}$	Turn-on delay time	$V_{CE} = 400\text{ V}$ , $I_C = 40\text{ A}$ , $V_{GE} = 15\text{ V}$ , $R_G = 5\ \Omega$ (see Figure 27. Test circuit for inductive load switching)		40	-	ns	
$t_r$	Current rise time			13	-		
$(di/dt)_{on}$	Turn-on current slope				2413	-	A/ $\mu$ s
$t_{d(off)}$	Turn-off-delay time				142	-	ns
$t_f$	Current fall time				27	-	
$E_{on}^{(1)}$	Turn-on switching energy				498	-	$\mu$ J
$E_{off}^{(2)}$	Turn-off switching energy				363	-	
$E_{ts}$	Total switching energy			861	-		
$t_{d(on)}$	Turn-on delay time	$V_{CE} = 400\text{ V}$ , $I_C = 40\text{ A}$ , $V_{GE} = 15\text{ V}$ , $R_G = 5\ \Omega$ , $T_J = 175\text{ }^\circ\text{C}$ (see Figure 27. Test circuit for inductive load switching)		38	-	ns	
$t_r$	Current rise time				14		-
$(di/dt)_{on}$	Turn-on current slope				2186	-	A/ $\mu$ s
$t_{d(off)}$	Turn-off-delay time				141	-	ns
$t_f$	Current fall time				61	-	
$E_{on}^{(1)}$	Turn-on switching energy				1417	-	$\mu$ J
$E_{off}^{(2)}$	Turn-off switching energy				764	-	
$E_{ts}$	Total switching energy			2181	-		

1. Including the reverse recovery of the diode.
2. Including the tail of the collector current.

**Table 6. Diode switching characteristics (inductive load)**

Symbol	Parameter	Test conditions	Min.	Typ.	Max.	Unit	
$t_{rr}$	Reverse recovery time	$I_F = 40\text{ A}$ , $V_R = 400\text{ V}$ , $V_{GE} = 15\text{ V}$ $di/dt = 100\text{ A}/\mu\text{s}$ (see Figure 27. Test circuit for inductive load switching)	-	62	-	ns	
$Q_{rr}$	Reverse recovery charge			-	99	-	nC
$I_{rrm}$	Reverse recovery current			-	3.3	-	A
$dI_{rr}/dt$	Peak rate of fall of reverse recovery current during $t_b$			-	187	-	A/ $\mu$ s
$E_{rr}$	Reverse recovery energy			-	68	-	$\mu$ J
$t_{rr}$	Reverse recovery time	$I_F = 40\text{ A}$ , $V_R = 400\text{ V}$ , $V_{GE} = 15\text{ V}$ , $T_J = 175\text{ }^\circ\text{C}$ di/ $dt = 100\text{ A}/\mu\text{s}$ (see Figure 27. Test circuit for inductive load switching)	-	310	-	ns	
$Q_{rr}$	Reverse recovery charge			-	1550	-	nC
$I_{rrm}$	Reverse recovery current			-	10	-	A
$dI_{rr}/dt$	Peak rate of fall of reverse recovery current during $t_b$			-	70	-	A/ $\mu$ s
$E_{rr}$	Reverse recovery energy			-	674	-	$\mu$ J

## 2.1 Electrical characteristics (curves)

**Figure 1. Power dissipation vs case temperature**

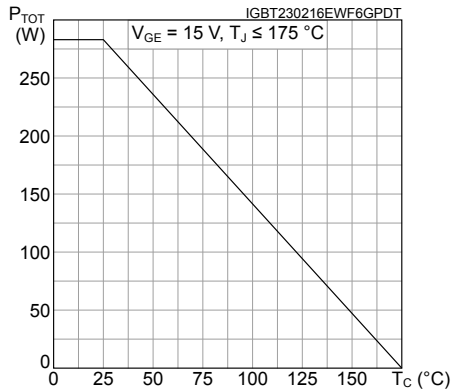

**Figure 2. Collector current vs case temperature**

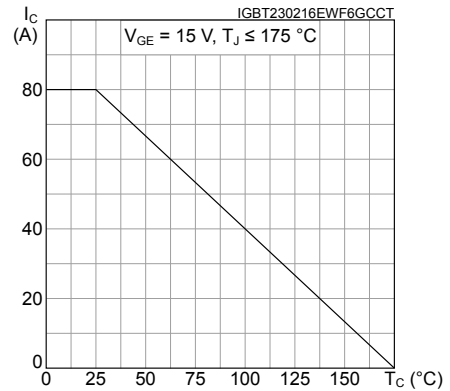

**Figure 3. Output characteristics (T<sub>J</sub> = 25 °C)**

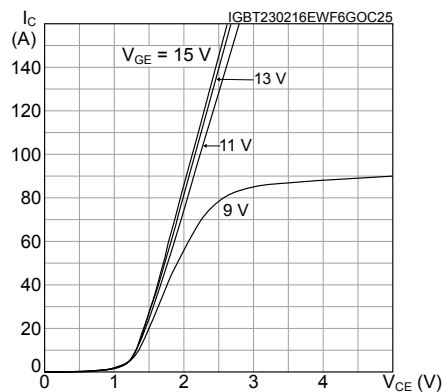

**Figure 4. Output characteristics (T<sub>J</sub> = 175 °C)**

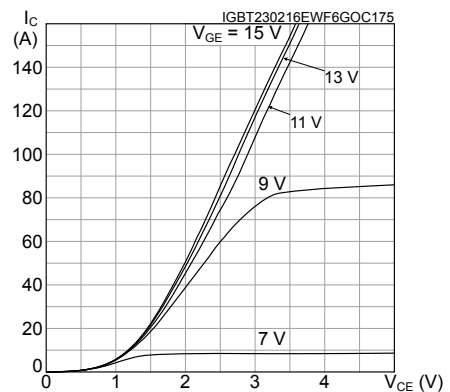

**Figure 5. V<sub>CE(sat)</sub> vs junction temperature**

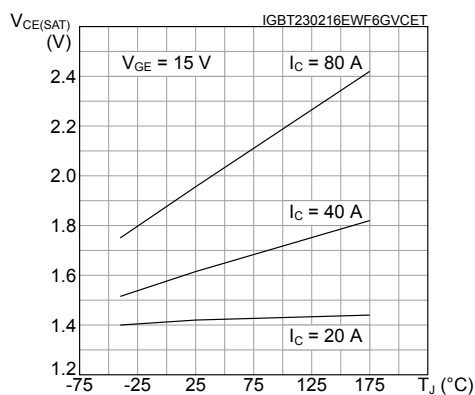

**Figure 6. V<sub>CE(sat)</sub> vs collector current**

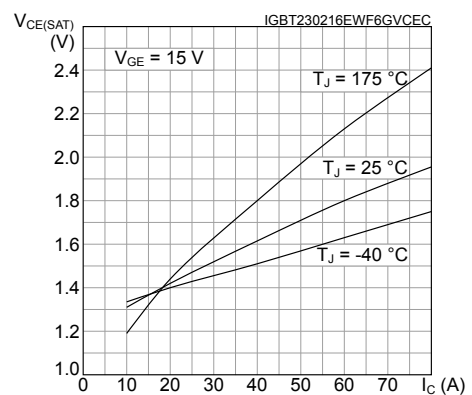

**Figure 7. Collector current vs switching frequency**

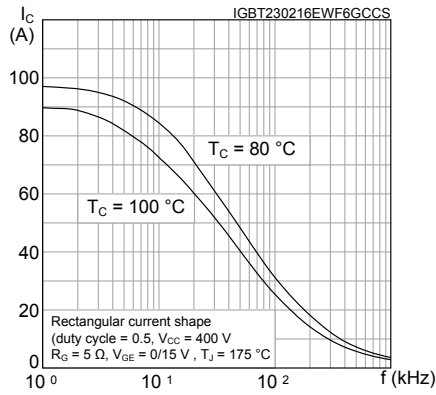

**Figure 8. Forward bias safe operating area**

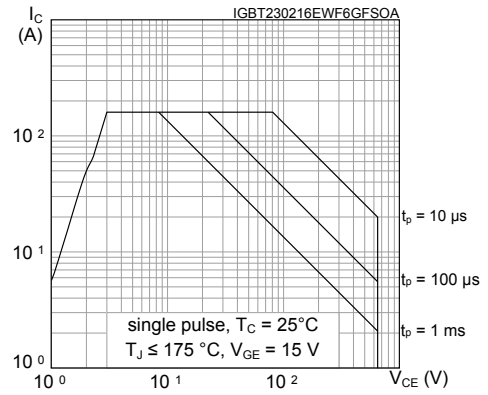

**Figure 9. Transfer characteristics**

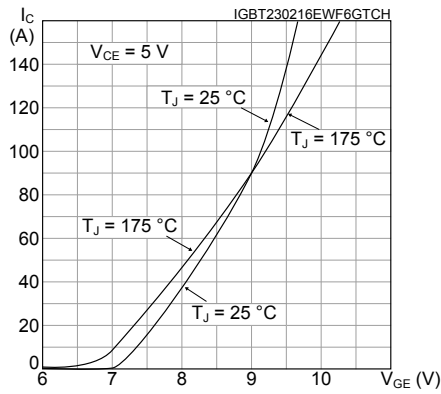

**Figure 10. Diode Vf vs forward current**

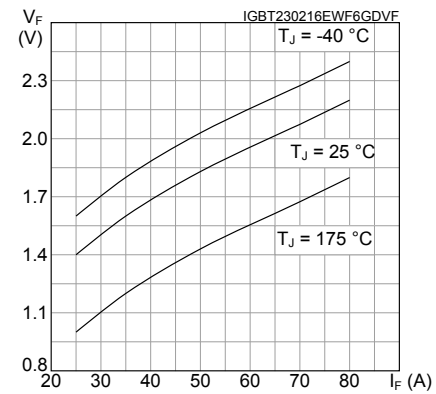

**Figure 11. Normalized VGE(th) vs junction temperature**

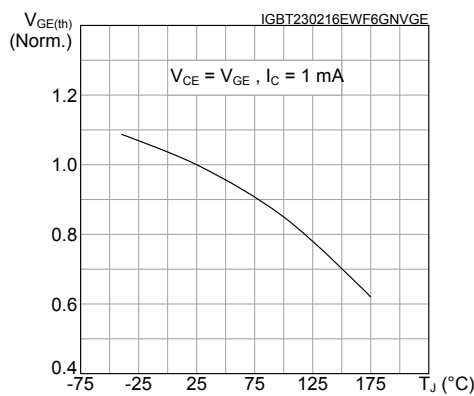

**Figure 12. Normalized V(BR)CES vs junction temperature**

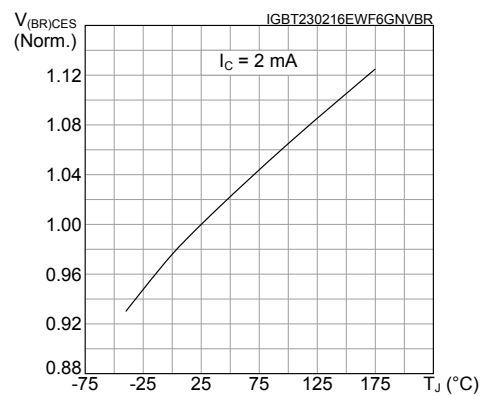

Figure 13. Capacitance variations

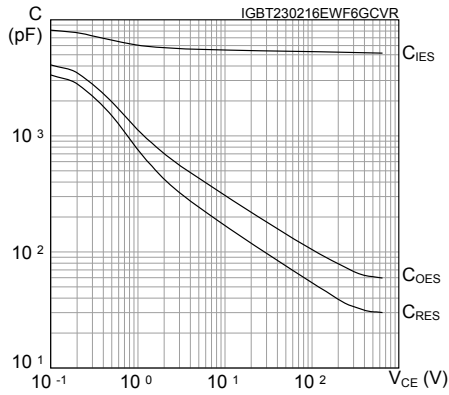

Figure 14. Gate charge vs gate-emitter voltage

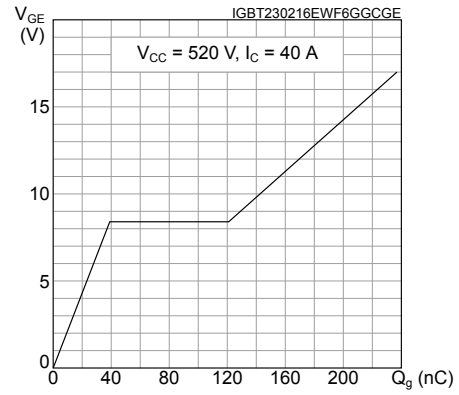

Figure 15. Switching energy vs collector current

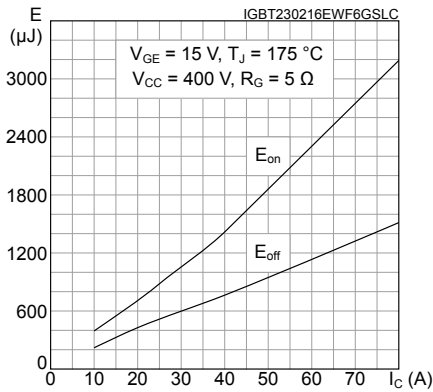

Figure 16. Switching energy vs gate resistance

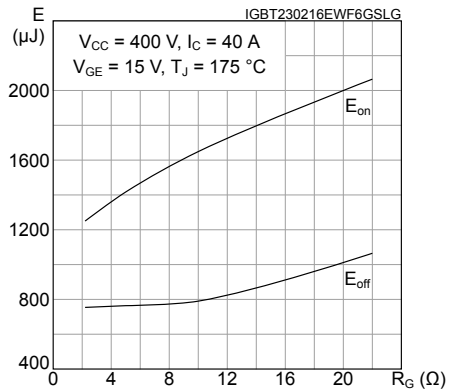

Figure 17. Switching energy vs temperature

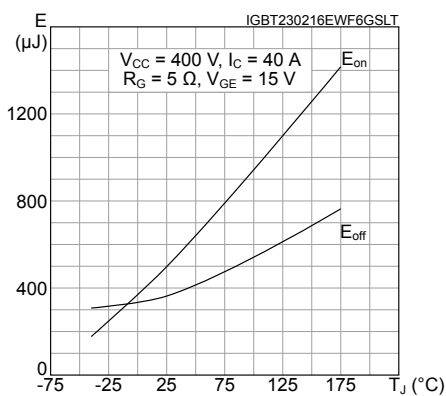

Figure 18. Switching energy vs collector emitter voltage

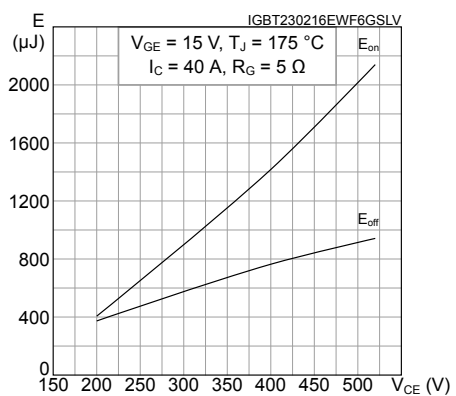

Figure 19. Switching times vs collector current

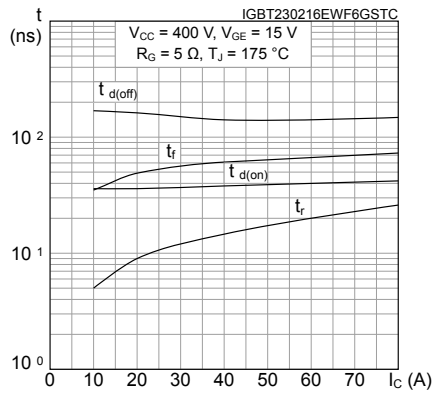

Figure 20. Switching times vs gate resistance

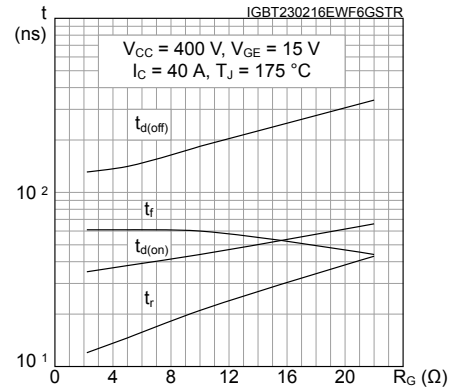

Figure 21. Reverse recovery current vs diode current slope

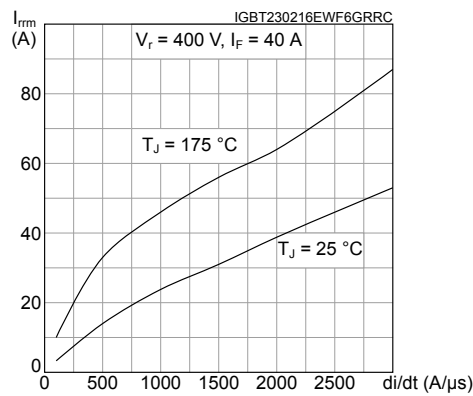

Figure 22. Reverse recovery time vs diode current slope

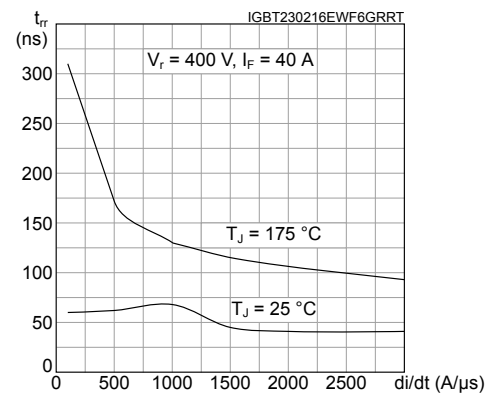

Figure 23. Reverse recovery charge vs diode current slope

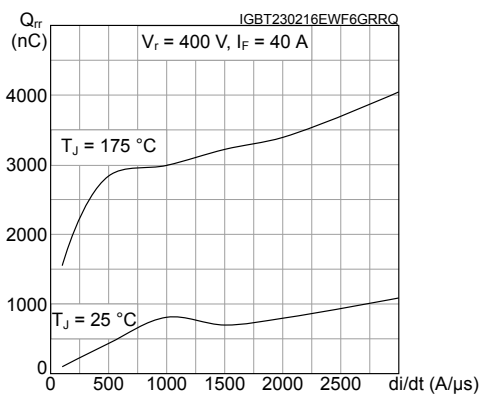

Figure 24. Reverse recovery energy vs diode current slope

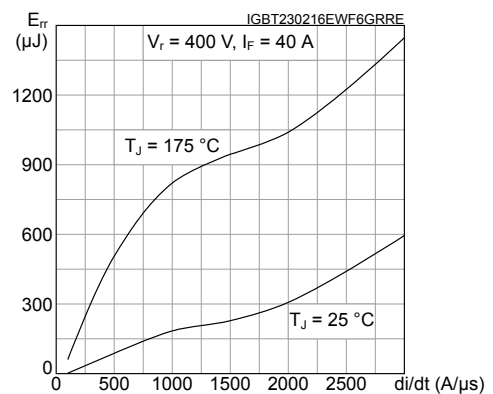

Figure 25. Thermal impedance for IGBT

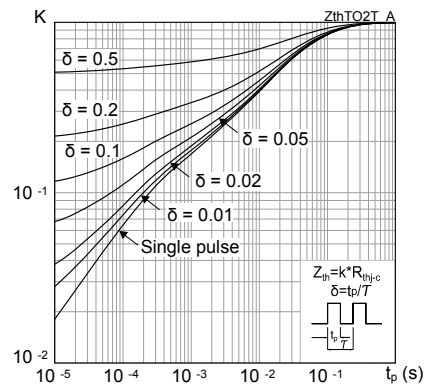
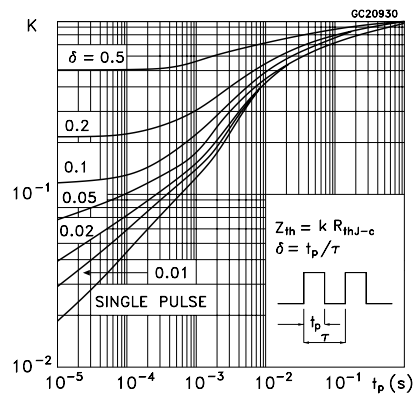
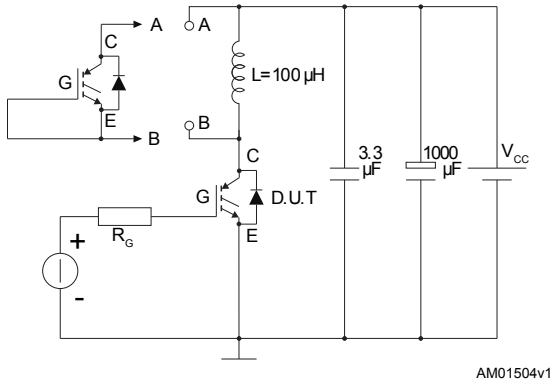
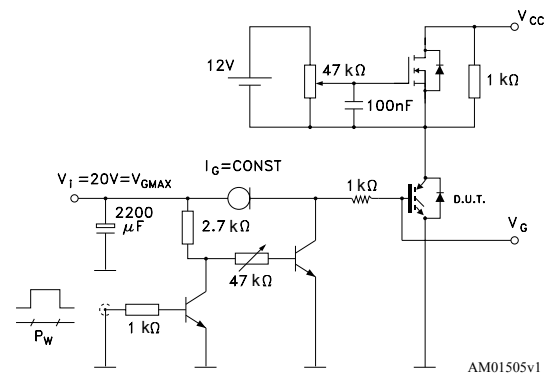
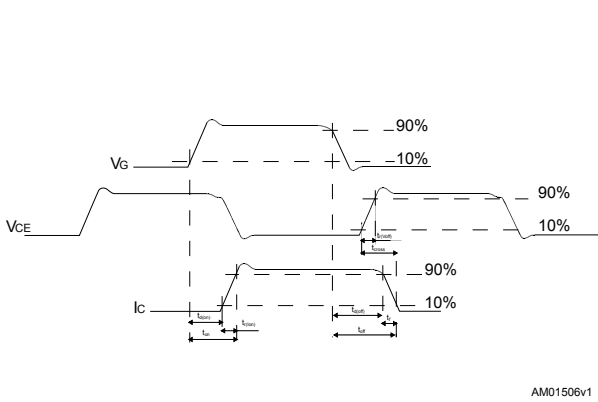
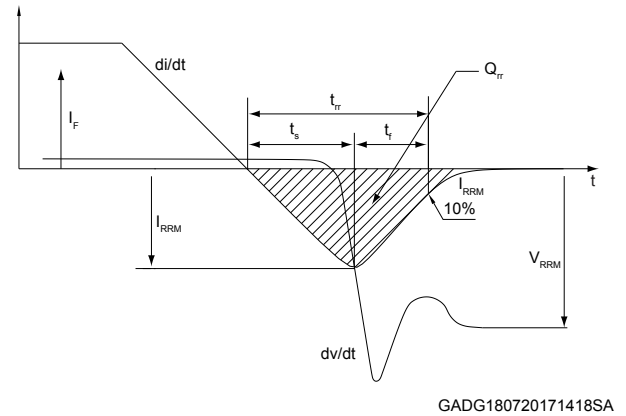

Figure 26. Thermal impedance for diode



### 3 Test circuits

**Figure 27. Test circuit for inductive load switching**

**Figure 28. Gate charge test circuit**

**Figure 29. Switching waveform**

**Figure 30. Diode reverse recovery waveform**

## **4** Package information

---

In order to meet environmental requirements, ST offers these devices in different grades of **ECOPACK** packages, depending on their level of environmental compliance. ECOPACK specifications, grade definitions and product status are available at: [www.st.com](http://www.st.com). ECOPACK is an ST trademark.

### 4.1 TO-247 long leads package information

Figure 31. TO-247 long leads package outline

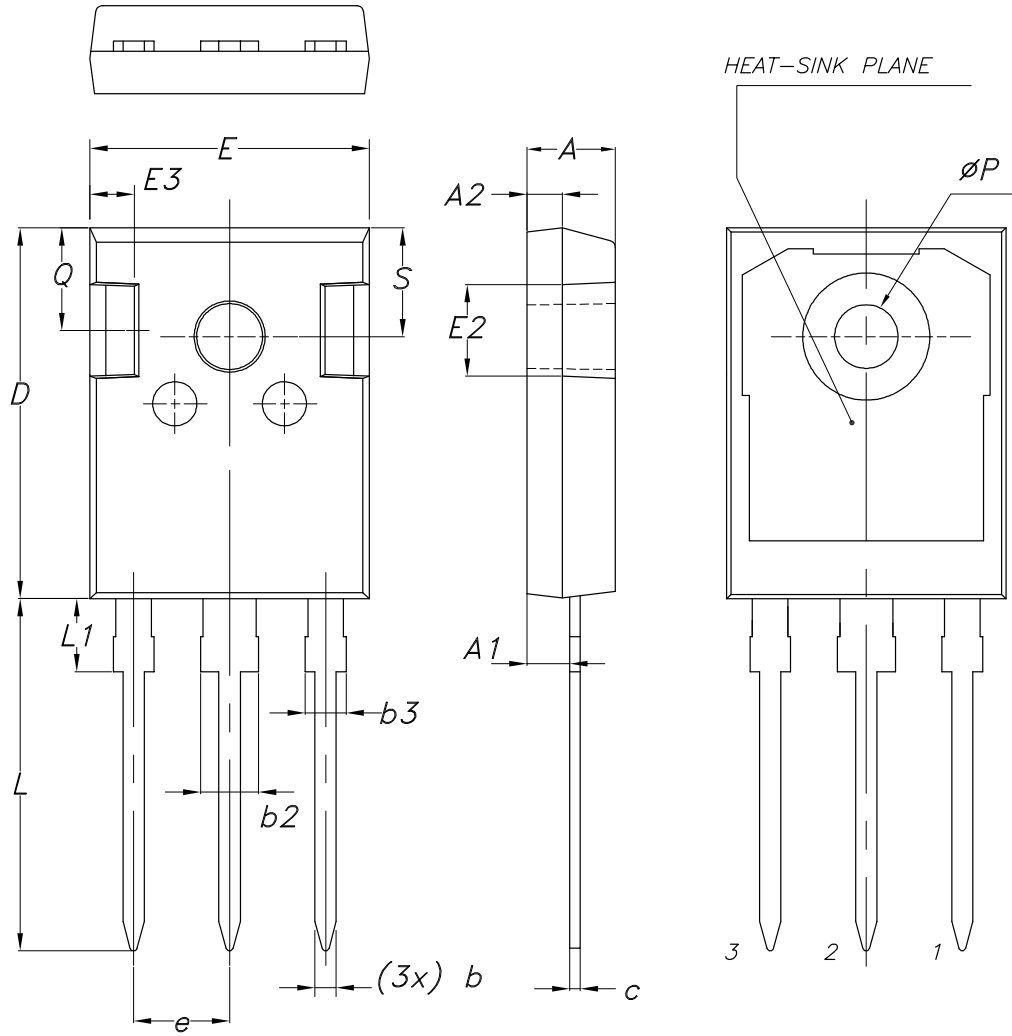

8463846\_2\_F

**Table 7. TO-247 long leads package mechanical data**

Dim.	mm		
	Min.	Typ.	Max.
A	4.90	5.00	5.10
A1	2.31	2.41	2.51
A2	1.90	2.00	2.10
b	1.16		1.26
b2			3.25
b3			2.25
c	0.59		0.66
D	20.90	21.00	21.10
E	15.70	15.80	15.90
E2	4.90	5.00	5.10
E3	2.40	2.50	2.60
e	5.34	5.44	5.54
L	19.80	19.92	20.10
L1			4.30
P	3.50	3.60	3.70
Q	5.60		6.00
S	6.05	6.15	6.25

## Revision history

**Table 8. Document revision history**

Date	Revision	Changes
06-Jun-2016	1	Initial version. Part number previously included in datasheet DocID024363.
24-Jun-2019	2	Modified <a href="#">Table 1. Absolute maximum ratings</a> . Minor text changes.

---

## Contents

<b>1</b>	<b>Electrical ratings</b> .....	<b>2</b>
<b>2</b>	<b>Electrical characteristics</b> .....	<b>3</b>
<b>2.1</b>	<b>Electrical characteristics (curves)</b> .....	<b>4</b>
<b>3</b>	<b>Test circuits</b> .....	<b>10</b>
<b>4</b>	<b>Package information</b> .....	<b>11</b>
<b>4.1</b>	<b>TO-247 long leads package information</b> .....	<b>11</b>
	<b>Revision history</b> .....	<b>14</b>

**IMPORTANT NOTICE – PLEASE READ CAREFULLY**

STMicroelectronics NV and its subsidiaries (“ST”) reserve the right to make changes, corrections, enhancements, modifications, and improvements to ST products and/or to this document at any time without notice. Purchasers should obtain the latest relevant information on ST products before placing orders. ST products are sold pursuant to ST’s terms and conditions of sale in place at the time of order acknowledgement.

Purchasers are solely responsible for the choice, selection, and use of ST products and ST assumes no liability for application assistance or the design of Purchasers’ products.

No license, express or implied, to any intellectual property right is granted by ST herein.

Resale of ST products with provisions different from the information set forth herein shall void any warranty granted by ST for such product.



ST and the ST logo are trademarks of ST. For additional information about ST trademarks, please refer to [www.st.com/trademarks](http://www.st.com/trademarks). All other product or service names are the property of their respective owners.

Information in this document supersedes and replaces information previously supplied in any prior versions of this document.

© 2019 STMicroelectronics – All rights reserved

## Looking for pricing, stock, or lifecycle information?

Click below to explore more details on WIN SOURCE:

-  [View STGW40H65DFB](#) on WIN SOURCE
-  [STMicroelectronics](#) Information

## Optimize Your Supply Chain with WIN SOURCE Solutions

-  Global Sourcing Solution
-  Obsolete Management
-  Cost Control Management
-  Shortage Management
-  Alternative Solution
-  Excess Inventory Management