



**THE DATASHEET OF  
SP6213EC5-L-3-3**



## Micropower, SC-70, 100mA CMOS LDO Regulator

### FEATURES

- Tiny 5-pin SC-70 Package
- Guaranteed 100 mA Output
- 2.5% Output Voltage Accuracy
- Low Dropout Voltage: 250 mV at 100mA
- Low Quiescent Current: 65  $\mu$ A
- Low Ground Current: 135  $\mu$ A @  $I_L = 100$ mA
- Low Shutdown Current: 1  $\mu$ A MAX
- Current Limit: 190mA
- Thermal Shutdown: 168°C
- Good Load and Line Regulation
- Fast Transient Response:  $T_{ON}/T_{OFF}=80\mu$ s
- Low Temperature Coefficient
- Unconditionally Stable with 1 $\mu$ F Ceramic
- Fixed Outputs: 1.8V, 2.5V, 2.7V, 2.85V, 3.0V, 3.3V, 5V
- 100mA Replacement for 80mA MIC5213 & TC1016 (SP6213)
- 100mA Replacement for 80mA NCP512 (SP6214)

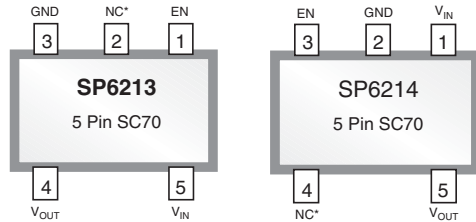

\*connect to GND for enhanced thermal performance

*Now Available in Lead Free Packaging*

### APPLICATIONS

- Digital Cordless Phones
- Cellular Phones
- PDAs
- Digital Still Cameras
- MP3 Players
- Battery-Powered Equipment
- Medical Devices
- Data Cable

### DESCRIPTION

The SP6213/4 is a 100mA CMOS linear voltage regulator offered in an SC-70 package that reduces board space requirements by 50% over a SOT-23 package. The SP6213/4 features low dropout voltage (250mV at 100mA), low ground current (135 $\mu$ A at full load) and low, 65 $\mu$ A quiescent current. Designed specifically for hand-held, battery powered devices, the device includes an enable/shutdown pin. Regulator ground current increases only slightly in dropout to extend battery life. The SP6213/4 is offered in an industry standard 5-pin SC-70 package. SP6213/4 is available in 1.8V, 2.5V, 2.7V, 2.85V, 3.0V, 3.3V and 5.0V fixed output voltages.

### FUNCTIONAL DIAGRAM

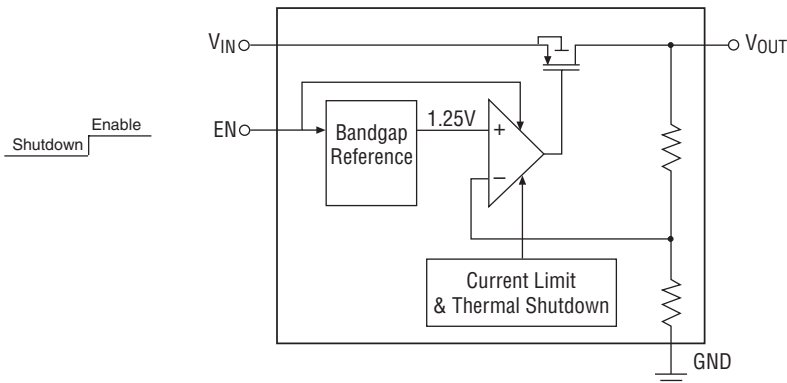

## ABSOLUTE MAXIMUM RATINGS (Note 1)

Supply Input Voltage ( $V_{IN}$ ).....	-2V to 7V
Output Voltage ( $V_{OUT}$ ).....	-0.6 to ( $V_{IN} + 1V$ )
Enable Input Voltage ( $V_{EN}$ ).....	-2V to 7V
Power Dissipation ( $P_D$ ).....	Internally Limited, Note 3
Lead Temperature (soldering 5s).....	260°C
Storage Temperature.....	-65°C to +150°C

(Note 1) These are stress ratings only and functional operation of the device at these ratings or any other above those indicated in the operation sections of the specifications below is not implied. Exposure to absolute maximum rating conditions for extended periods of time may affect reliability.

## OPERATING RATINGS (Note 2)

Input Voltage ( $V_{IN}$ ).....	+2.5V to +6V
Enable Input Voltage ( $V_{EN}$ ).....	ZeroV to +6V
Junction Temperature ( $T_J$ ).....	-40°C to +125°C

Thermal Resistance.....	(Note 3)
SC-70-5 ( $\theta_{JA}$ ).....	330°C/W

## ELECTRICAL CHARACTERISTICS

$V_{IN} = V_{OUT} + 0.5V$ ,  $I_L = 100\mu A$ ,  $C_{IN} = 1\mu F$ ,  $C_{OUT} = 1\mu F$ ,  $T_J = 25^\circ C$ , unless otherwise noted. The ♦ denotes the specifications which apply over the full operating temperature range, unless otherwise specified.

PARAMETER	MIN	TYP	MAX	UNITS	♦	CONDITIONS
Output Voltage Accuracy, ( $V_{OUT}$ )	-2.5 -4		2.5 4	%	♦	Variation from specified $V_{OUT}$
Output Voltage Temperature Coefficient, Note 4, ( $\Delta V_{OUT}/\Delta T$ )		60		ppm/ ° C		
Minimum Supply Voltage		2.50 2.55 2.75	2.70 2.85 3.00	V		$I_{OUT} = 100\mu A$ $I_{OUT} = 50mA$ $I_{OUT} = 100mA$
Line Regulation, ( $\Delta V_{OUT}/V_{IN}$ )		0.05	0.2	%/V	♦	$V_{IN} = (V_{OUT} + 0.5V)$ to 6V
SP6213-1.8V Line Regulation		0.05	0.2	%/V	♦	$V_{IN} = 2.8V$ to 6V
Load Regulation, Note 5, ( $\Delta V_{OUT}$ )		0.4	0.8	%	♦	$I_L = 0.1mA$ to 100mA, $V_{IN} = V_{OUT} + 1V$
SP6213-1.8V Load Regulation		0.4	0.8	%	♦	$I_L = 0.1mA$ to 100mA, $V_{IN} = 3.0V$
Dropout Voltage, Note 6, ( $V_{IN} - V_{OUT}$ )		0.25	4	mV	♦	$I_L = 100\mu A$
		130	250	mV	♦	$I_L = 50mA$
		250	500	mV	♦	$I_L = 100mA$
Quiescent Current, ( $I_{GND}$ )		0.01 65	1 125	$\mu A$	♦	$V_{EN} \leq 0.4V$ (Shutdown) $V_{EN} \geq 1.6V$ (Operating), $I_L = 0\mu A$
		65	125	$\mu A$	♦	$V_{EN} \geq 1.6V$ , $I_L = 100\mu A$
Ground Pin Current, Note 7, ( $I_{GND}$ )		100	175	$\mu A$	♦	$V_{EN} \geq 1.6V$ , $I_L = 50mA$
		135	250	$\mu A$	♦	$V_{EN} \geq 1.6V$ , $I_L = 100mA$
		74 40				Frequency = 100Hz, $I_L = 10mA$ Frequency = 400kHz, $I_L = 10mA$
Power Supply Rejection Ratio, (PSRR)				dB		
Current Limit, ( $I_{CL}$ )	120	190	350	mA	♦	
Thermal Limit		168 153		° C		Turns On Turns Off
Thermal Regulation, ( $\Delta V_{OUT}/\Delta P_D$ ), Note 8		0.05		%/W		
Output Noise ( $e_{NO}$ )		250		$\mu V_{rms}$		$I_L = 50mA$ , $C_L = 1\mu F$ , 10Hz to 100kHz

## ELECTRICAL CHARACTERISTICS

$V_{IN} = V_{OUT} + 0.5V$ ,  $I_L = 100\mu A$ ,  $C_{IN} = 1\mu F$ ,  $C_{OUT} = 1\mu F$ ,  $T_J = 25^\circ C$ , unless otherwise noted. The ♦ denotes the specifications which apply over the full operating temperature range, unless otherwise specified.

PARAMETER	MIN	TYP	MAX	UNITS	◆	CONDITIONS
<b>ENABLE INPUT</b>						
Enable Input Logic-Low Voltage, ( $V_{IL}$ )			0.4	V	◆	Regulator Shutdown
Enable Input Logic-High Voltage, ( $V_{IH}$ )	1.6			V	◆	Regulator Enabled
Enable Input Current, ( $I_{IL}$ ), ( $I_{IH}$ )		0.01	1	$\mu A$	◆	$V_{IL} \leq 0.4V$
		0.01	1	$\mu A$	◆	$V_{IH} \geq 1.6V$
Turn on Time ( $T_{ON}$ )		80	165	$\mu s$		$I_{OUT} = 50mA$
Turn off Time ( $T_{OFF}$ )		80	175	$\mu s$		$I_{OUT} = 100\mu A$ $I_{OUT} = 100mA$
		30	35			

**Note 1.** Exceeding the absolute maximum rating may damage the device.

**Note 2.** The device is not guaranteed to function outside its operating rating.

**Note 3.** The maximum allowable power dissipation at any  $T_A$  (ambient temperature) is  $P_{D(MAX)} = (T_{J(MAX)} - T_A) / \theta_{JA}$ . Exceeding the maximum allowable power dissipation will result in excessive die temperature, and the regulator will go into thermal shutdown. The  $\theta_{JA}$  of the SP6213/4 (SC-70-5) is  $330^\circ C/W$  mounted on a PC board with minimum copper area (see "Thermal Considerations" section for further details).

**Note 4.** Output voltage temperature coefficient is defined as the worst case voltage change divided by the total temperature range.

**Note 5.** Load Regulation is measured at constant junction temperature using low duty cycle pulse testing. Parts are tested for load regulation in the load range. Changes in output voltage due to heating effects are covered by the thermal regulation specification.

**Note 6.** Dropout Voltage is defined as the input to output differential at which the output voltage drops 2% below its nominal value measured at 0.5V differential. Not applicable to output voltages less than 2.7V.

**Note 7.** Ground pin current is the regulator quiescent current. The total current drawn from the supply is the sum of the load current plus the ground pin current.

**Note 8.** Thermal regulation is defined as the change in output voltage at a time "t" after a change in power dissipation is applied, excluding load or line regulation effects. Specifications are for a 100mA load pulse at  $V_{IN} = 6V$  for  $t = 10ms$ .

**Note 9.** Devices are ESD sensitive. Handling precautions are recommended.

## PIN DESCRIPTION

PIN NUMBER	PIN NAME	SP6214 DESCRIPTION (FUNCTION)
1	$V_{IN}$	Supply Input
2	GND	Ground Connection
3	EN	Enable / Shutdown (Logic high=enable; logic low = shutdown)
4	NC	No Connection
5	$V_{OUT}$	Regulator Output

PIN NUMBER	PIN NAME	SP6213 DESCRIPTION (FUNCTION)
1	EN	Enable / Shutdown (Logic high=enable; logic low = shutdown)
2	NC	No Connection
3	GND	Ground Connection
4	$V_{OUT}$	Regulator Output
5	$V_{IN}$	Supply Input

## General Overview

### Enable/Shutdown Operation

The SP6213/4 is turned off by pulling the EN pin low and turned on by pulling it high. If this enable/shutdown feature is not required, EN should be tied to  $V_{IN}$  to keep the regulator output on at all times.

### Input Capacitor

Any good quality ceramic or tantalum capacitor may be used at the input. A small capacitor of about  $1\mu\text{F}$  is required from  $V_{IN}$  to GND if, for instance, a battery is used as the input.

### Output Capacitor

An output capacitor is required between  $V_{OUT}$  and GND to prevent oscillation. The minimum size of the output capacitor is a  $0.47\mu\text{F}$  ceramic. The given datasheet values relate to an IC with a ceramic output capacitor of  $1\mu\text{F}$ . Larger values make the IC more stable which means an improvement of the regulator's transient response. For a lower output current, the output capacitance can be chosen smaller in order to have the same output stability.

### No Load Stability

The SP6213/4 will remain stable and in regulation with no external load (other than the internal voltage driver) unlike many other voltage regulators. This is especially important in CMOS RAM keep-alive applications.

### Thermal Considerations

The SP6213/4 is designed to provide 100 mA of continuous current in a very tiny package. Maximum power dissipation can be calculated based on the output current and the voltage drop across the part. To determine the maximum power dissipation of the pack-

age, use the junction-to-ambient thermal resistance of the device and the following basic equation:

$$P_D = (T_{J(\max)} - T_A) / \theta_{JA}$$

$T_{J(\max)}$  is the maximum junction temperature of the die and is  $125^\circ\text{C}$ .  $T_A$  is the ambient operating temperature.  $\theta_{JA}$  is the junction-to-ambient thermal resistance for the regulator and is layout dependent. The actual power dissipation of the regulator circuit can be determined using one simple equation:

$$P_D = (V_{IN} - V_{OUT}) * I_{OUT} + V_{IN} * I_{GND}$$

Substituting  $P_{D(\max)}$  for  $P_D$  and solving for the operating conditions that are critical to the application will give the maximum operating conditions for the regulator circuit. For example, if we are operating the SP6213/4 at 3.0V output at room temperature, with a minimum footprint layout, we can determine the maximum input voltage for a set output current:

$$\begin{aligned} P_{D(\max)} &= [(125^\circ\text{C} - 25^\circ\text{C}) / (330^\circ\text{C}/\text{W})] \\ &= 303 \text{ mW}. \end{aligned}$$

To prevent the device from entering thermal shutdown, maximum power dissipation can not be exceeded. Using the output voltage of 3.0V and an output current of 100 mA, the maximum input voltage can be determined. Ground pin current can be taken from the electrical specifications table (0.135 mA at 100 mA). The maximum input voltage is determined as follows:

$$303\text{mW} = (V_{IN} - 3.0\text{V}) * 100\text{mA} + V_{IN} * 0.135\text{mA}$$

After calculations, we find that the maximum input voltage of a 3.0V application at 100mA of output current in an SC-70-5 package is 6.02V.

# TYPICAL PERFORMANCE CHARACTERISTICS

27°C,  $V_{IN}=4V$ ,  $I_L = 0.1mA$ ,  $C_{IN} = C_{OUT} = 1\mu F$  unless otherwise specified.

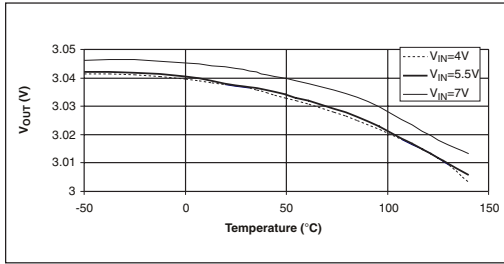

Output Voltage vs. Temperature ( $I_{OUT} = 0.1mA$ )

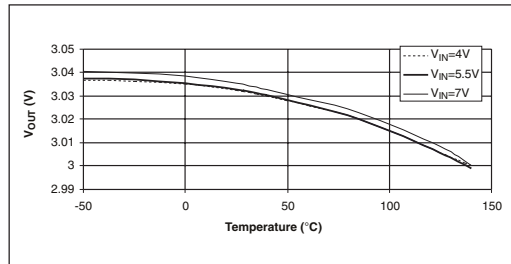

Output Voltage vs. Temperature ( $I_{OUT} = 10mA$ )

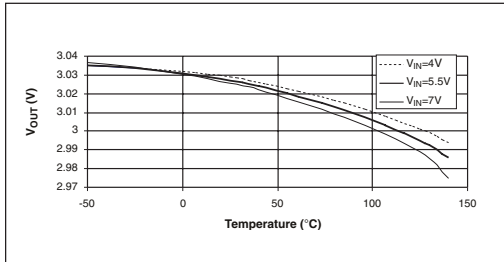

Output Voltage vs. Temperature ( $I_{OUT} = 50mA$ )

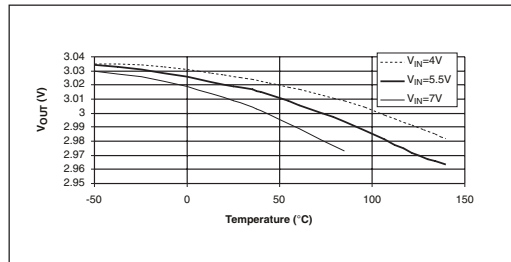

Output Voltage vs. Temperature ( $I_{OUT} = 100mA$ )

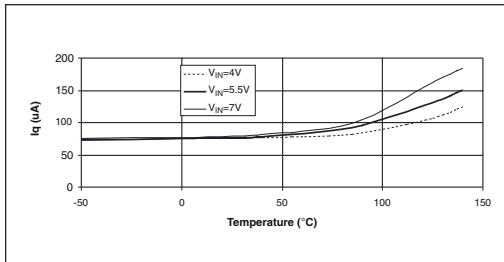

Quiescent Current vs. Temperature ( $I_{OUT} = 0A$ )

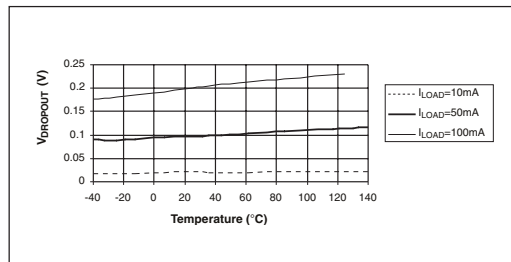

Dropout Voltage vs. Temperature

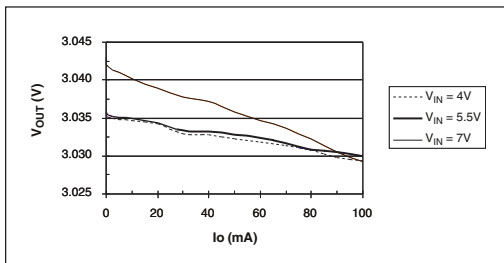

Output Voltage vs. Output Current

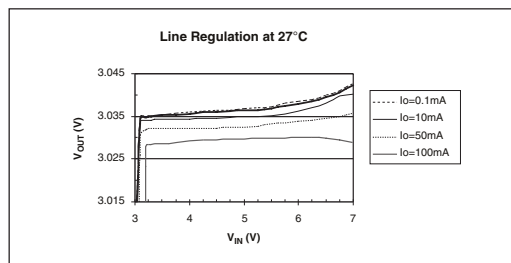

Output Voltage vs. Input Voltage

# TYPICAL PERFORMANCE CHARACTERISTICS

27°C,  $V_{IN}=4V$ ,  $I_L = 0.1mA$ ,  $C_{IN} = C_{OUT} = 1\mu F$  unless otherwise specified.

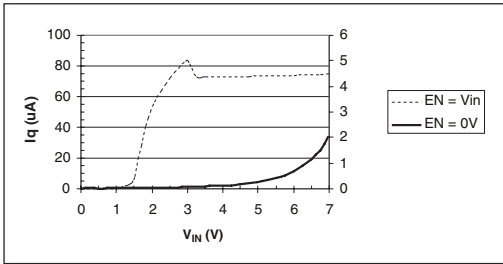

**Quiescent Current vs. Input Voltage**

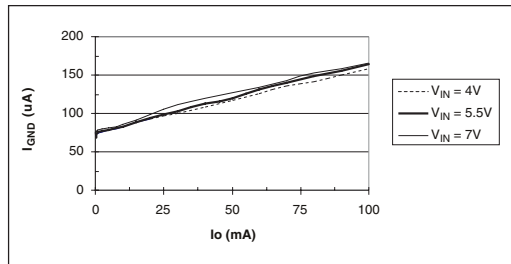

**Ground Current vs. Output Current**

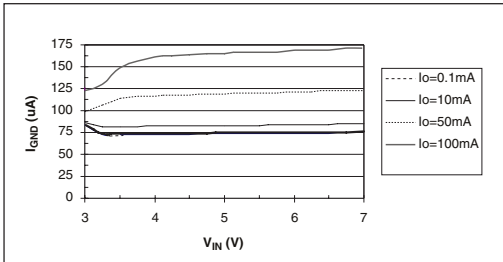

**Ground Current vs. Input Voltage**

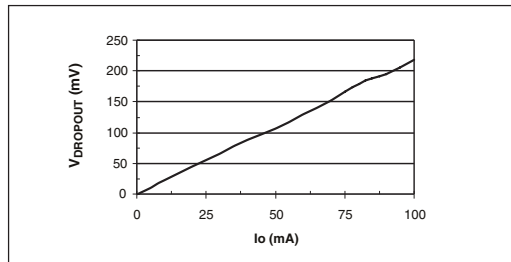

**Dropout Voltage vs. Output Current**

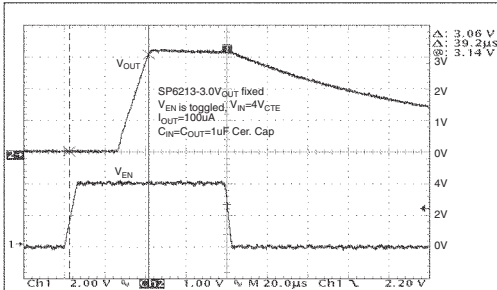

**Turn-on Characteristic ( $V_{IN} = 4V$ ,  $I_{OUT} = 100\mu A$ )**

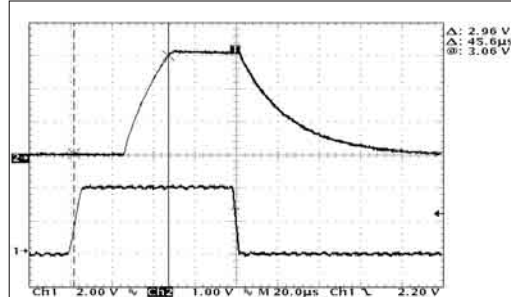

**Turn-on Characteristic ( $V_{IN} = 4V$ ,  $I_{OUT}=100mA$ )**

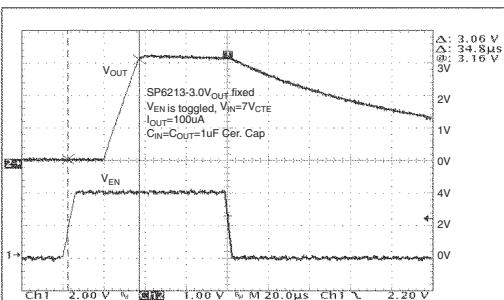

**Turn-on Characteristic ( $V_{IN} = 7V$ ,  $I_{OUT} = 100\mu A$ )**

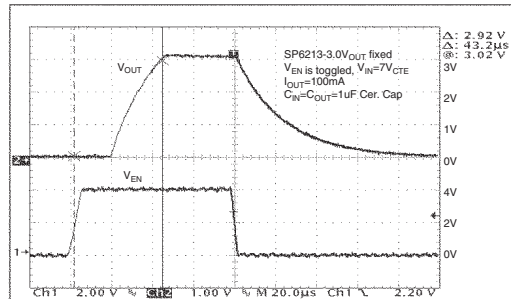

**Turn on Time ( $V_{IN} = 7V$ ,  $I_{OUT} = 100mA$ )**

# TYPICAL PERFORMANCE CHARACTERISTICS

27°C,  $V_{IN}=4V$ ,  $I_L = 0.1mA$ ,  $C_{IN} = C_{OUT} = 1\mu F$  unless otherwise specified.

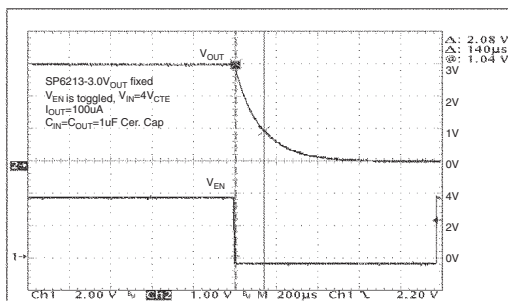

Turn off Time ( $V_{IN}=4V$ ,  $I_{OUT}=100\mu A$ )

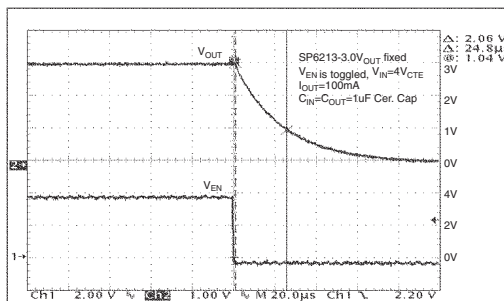

Turn off Time ( $V_{IN} = 4V$ ,  $I_{OUT} = 100mA$ )

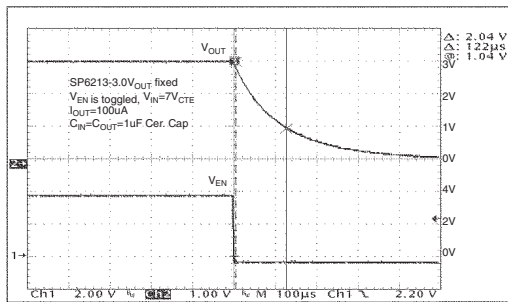

Turn off Time ( $V_{IN} = 7V$ ,  $I_{OUT} = 100\mu A$ )

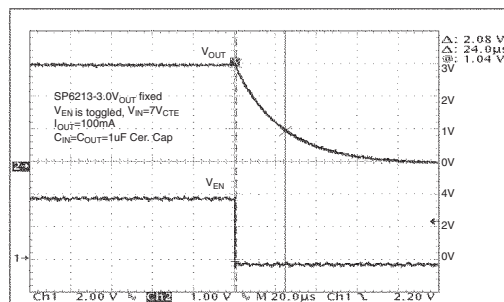

Turn off Time ( $V_{IN} = 7V$ ,  $I_{OUT} = 100mA$ )

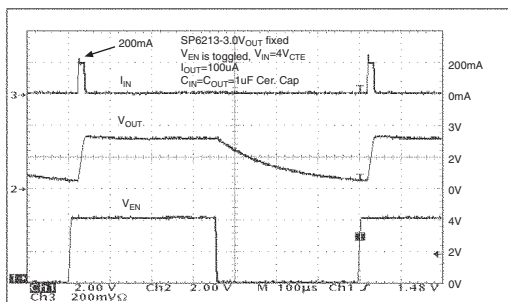

In-Rush Current ( $V_{IN} = 4V$ ,  $I_{OUT} = 100\mu A$ )

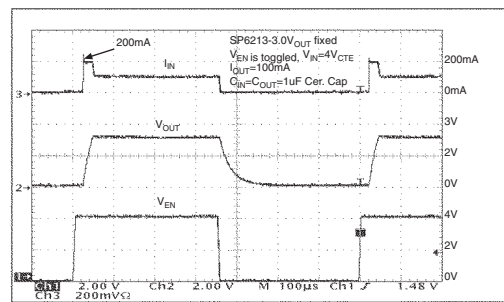

In-Rush Current ( $V_{IN} = 4V$ ,  $I_{OUT} = 100mA$ )

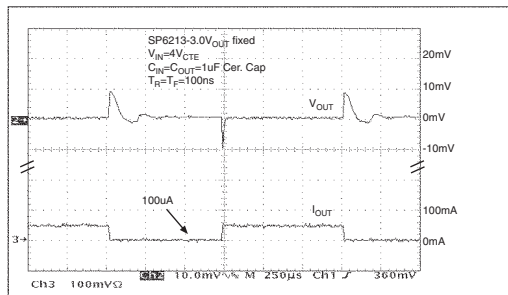

Load Transient Response ( $V_{IN} = 4V$ )

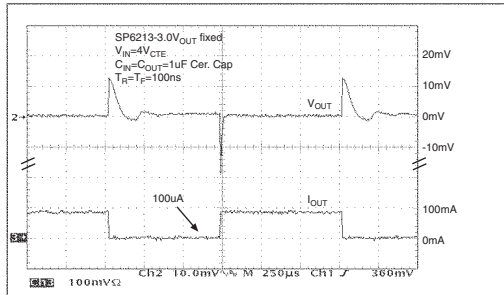

Load Transient Response ( $V_{IN} = 4V$ )

# TYPICAL PERFORMANCE CHARACTERISTICS

27°C,  $V_{IN}=4V$ ,  $I_L = 0.1mA$ ,  $C_{IN} = C_{OUT} = 1\mu F$  unless otherwise specified.

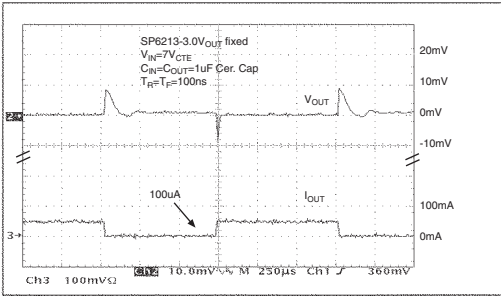

**Load Transient Response ( $V_{IN} = 7V$ )**

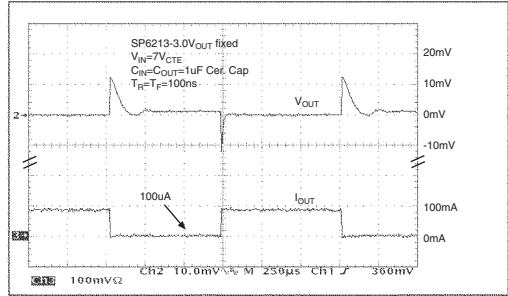

**Load Transient Response ( $V_{IN} = 7V$ )**

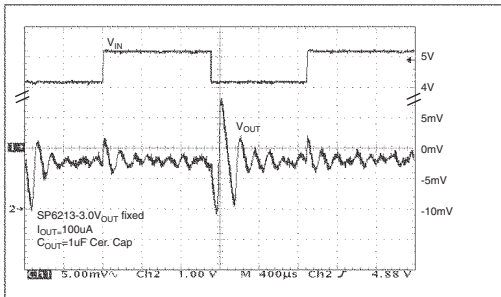

**Line Transient Response ( $V_{IN}=4V$ ,  $I_{OUT}=100\mu A$ )**

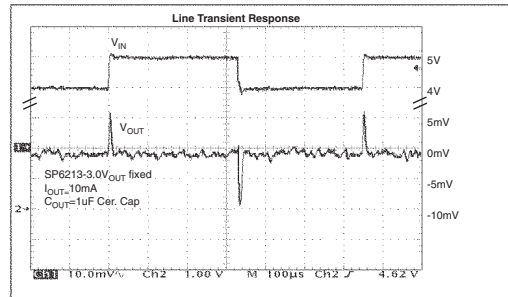

**Line Transient Response ( $V_{IN}=4V$ ,  $I_{OUT}=10mA$ )**

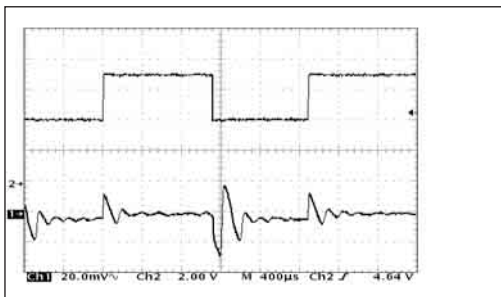

**Line Transient Response ( $V_{IN}=7V$ ,  $I_{OUT}=100\mu A$ )**

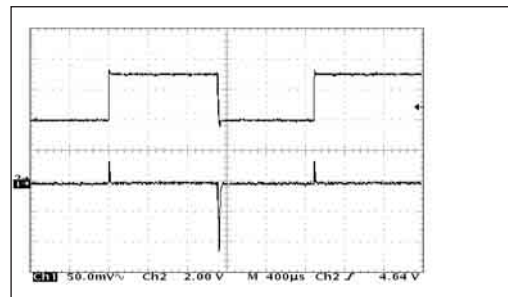

**Line Transient Response ( $V_{IN}=7V$ ,  $I_{OUT}=10\mu A$ )**

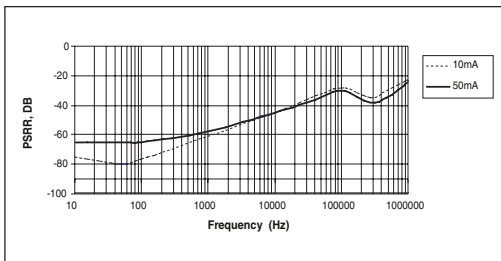

**Power Supply Rejection Ratio,  $V_o=3V$**



**ORDERING INFORMATION**

Part Number	Top Marking	Temperature Range	Voltage Option	Package Type
SP6213EC5-1-8	W00	-40°C to +125°C	1.8V	5 Pin SC-70
SP6213EC5-1-8/TR	W00	-40°C to +125°C	1.8V	5 Pin SC-70
SP6213EC5-2-5	F00	-40°C to +125°C	2.5V	5 Pin SC-70
SP6213EC5-2-5/TR	F00	-40°C to +125°C	2.5V	5 Pin SC-70
SP6213EC5-2-7	E00	-40°C to +125°C	2.7V	5 Pin SC-70
SP6213EC5-2-7/TR	E00	-40°C to +125°C	2.7V	5 Pin SC-70
SP6213EC5-2-85	D00	-40°C to +125°C	2.85V	5 Pin SC-70
SP6213EC5-2-85/TR	D00	-40°C to +125°C	2.85V	5 Pin SC-70
SP6213EC5-3-0	A00	-40°C to +125°C	3.0V	5 Pin SC-70
SP6213EC5-3-0/TR	A00	-40°C to +125°C	3.0V	5 Pin SC-70
SP6213EC5-3-3	C00	-40°C to +125°C	3.3V	5 Pin SC-70
SP6213EC5-3-3/TR	C00	-40°C to +125°C	3.3V	5 Pin SC-70
SP6213EC5-5-0	B00	-40°C to +125°C	5.0V	5 Pin SC-70
SP6213EC5-5-0/TR	B00	-40°C to +125°C	5.0V	5 Pin SC-70

SP6214EC5-1-8	D01	-40°C to +125°C	1.8V	5 Pin SC-70
SP6214EC5-1-8/TR	D01	-40°C to +125°C	1.8V	5 Pin SC-70
SP6214EC5-2-5	J01	-40°C to +125°C	2.5V	5 Pin SC-70
SP6214EC5-2-5/TR	J01	-40°C to +125°C	2.5V	5 Pin SC-70
SP6214EC5-2-7	K01	-40°C to +125°C	2.7V	5 Pin SC-70
SP6214EC5-2-7/TR	K01	-40°C to +125°C	2.7V	5 Pin SC-70
SP6214EC5-2-85	L01	-40°C to +125°C	2.85V	5 Pin SC-70
SP6214EC5-2-85/TR	L01	-40°C to +125°C	2.85V	5 Pin SC-70
SP6214EC5-3-0	M01	-40°C to +125°C	3.0V	5 Pin SC-70
SP6214EC5-3-0/TR	M01	-40°C to +125°C	3.0V	5 Pin SC-70
SP6214EC5-3-3	H01	-40°C to +125°C	3.3V	5 Pin SC-70
SP6214EC5-3-3/TR	H01	-40°C to +125°C	3.3V	5 Pin SC-70
SP6214EC5-5-0	N01	-40°C to +125°C	5.0V	5 Pin SC-70
SP6214EC5-5-0/TR	N01	-40°C to +125°C	5.0V	5 Pin SC-70

Available in lead free packaging. To order add "-L" suffix to part number.

Example: SP6214EC5-3-3/TR = standard; SP6214EC5-L-3-3/TR = lead free.

Pack quantity is 3000 for SC70-5.

Lead Free packaging can be identified by a Bar "l" to the left of the standard Top Marking.



**ANALOG EXCELLENCE**



**Sipex Corporation**

**Headquarters and  
Sales Office**  
233 South Hillview Drive  
Milpitas, CA 95035  
TEL: (408) 934-7500  
FAX: (408) 935-7600







Sipex Corporation reserves the right to make changes to any products described herein. Sipex does not assume any liability arising out of the application or use of any product or circuit described herein; neither does it convey any license under its patent rights nor the rights of others.

## Looking for pricing, stock, or lifecycle information?

Click below to explore more details on WIN SOURCE:

-  [View SP6213EC5-L-3-3 on WIN SOURCE](#)
-  [MaxLinear Inc Information](#)

## Optimize Your Supply Chain with WIN SOURCE Solutions

-  Global Sourcing Solution
-  Obsolete Management
-  Cost Control Management
-  Shortage Management
-  Alternative Solution
-  Excess Inventory Management