



**THE DATASHEET OF
SPX29151T5-L-1-8**



1.5A Low Dropout Voltage Regulator

FEATURES

- Adjustable Output Down to 1.25V
- 1% Output Accuracy
- Output Current of 1.5A
- Low Dropout Voltage of 390mV @ 1.5A
- Extremely Tight Load and Line Regulation
- Extremely Fast Transient Response
- Reverse-Battery Protection
- Zero Current Shutdown (5 pin version)
- Error Flag Signal Output for Out of Regulation State (5 pin version)
- Standard TO-220 and TO-263 Packages

APPLICATIONS

- Powering VGA and Sound Cards
- LCD Monitors
- USB Power Supplies
- PowerPC™ Supplies
- SMPS Post Regulators
- High-efficiency “Green” Computer Systems
- High-efficiency Linear Power Supplies
- Portable Instrumentation
- Constant Current Regulators
- Adjustable Power Supplies
- Battery Chargers

DESCRIPTION

The SPX29150/51/52/53 are 1.5A, highly accurate voltage regulators with a low dropout voltage of 390mV (typical) @ 1.5A. These regulators are specifically designed for low voltage applications that require a low dropout voltage and a fast transient response. They are fully fault protected against over-current, reverse battery, and positive and negative voltage transients. On-chip trimming adjusts the reference voltage to 1% initial accuracy. Other features in the 5 pin versions include Enable and Error Flag.

The SPX29150/51/52/53 is offered in 3-pin and 5-pin TO-220 & TO-263 packages. For a 3A version, refer to the SPX29300 data sheet.

TYPICAL APPLICATION CIRCUITS

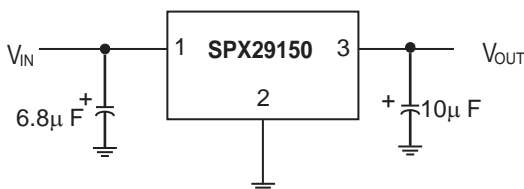

Figure 1. Fixed Output Linear Regulator

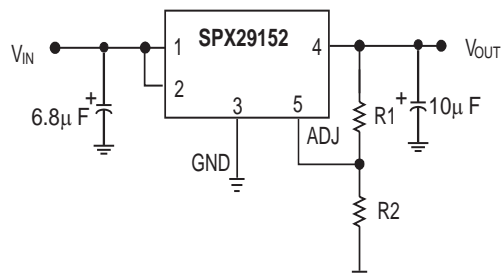

Figure 2. Adjustable Output Linear Regulator

ABSOLUTE MAXIMUM RATINGS

Storage Temperature Range.....-65°C to +150°C

Operating Junction Temperature Range.....-40°C to +125°C

Input Voltage (Note 7).....16V

ELECTRICAL CHARACTERISTICS

at $V_{IN}=V_{OUT} + 1V$ and $I_{OUT} = 10mA$, $C_{IN} = 6.8\mu F$, $C_{OUT} = 10\mu F$, $T_A = 25^\circ C$, unless otherwise specified. The **Boldface** applies over the junction temperature range. Adjustable versions are set to 5.0V.

| PARAMETER | CONDITIONS | Typ | SPX29150/51 | | Units |
|---|---|-------------------|-----------------------|-----------------------|---------------|
| | | | Min | Max | |
| 1.8V Version | | | | | |
| Output Voltage | $I_{OUT} = 10mA$ $10mA \leq I_{OUT} \leq 1.5A$, $2.5V \leq V_{IN} \leq 16V$ | 1.8 1.8 | 1.782 1.764 | 1.818 1.836 | V |
| 2.5V Version | | | | | |
| Output Voltage | $I_{OUT} = 10mA$ $10mA \leq I_{OUT} \leq 1.5A$, $3.5V \leq V_{IN} \leq 16V$ | 2.5 2.5 | 2.475 2.450 | 2.525 2.550 | V |
| 3.3V Version | | | | | |
| Output Voltage | $I_{OUT} = 10mA$ $10mA \leq I_{OUT} \leq 1.5A$, $4.3V \leq V_{IN} \leq 16V$ | 3.3 3.3 | 3.267 3.234 | 3.333 3.366 | V |
| 5.0V Version | | | | | |
| Output Voltage | $I_{OUT} = 10mA$ $10mA \leq I_{OUT} \leq 1.5A$, $6.0V \leq V_{IN} \leq 16V$ | 5.0 5.0 | 4.950 4.900 | 5.050 5.100 | V |
| All Voltage Options SPX29150/51/52/53 | | | | | |
| Line Regulation | $I_O = 10mA$, $(V_{OUT} + 1V) \leq V_{IN} \leq 16V$ | 0.1 | | 0.5 | % |
| Load Regulation | $V_{IN} = V_{OUT} + 1V$, $10mA \leq I_{OUT} \leq I_{FULL-LOAD}$ | 0.2 | | 1 | % |
| $\frac{\Delta V}{\Delta T}$ | Output Voltage Temperature Coefficient | 13 | | 100 | ppm/°C |
| Dropout Voltage (Note 1) (except 1.8V version) | $I_O = 100mA$ | 70 | | 200 | mV |
| | $I_O = 750mA$ | 230 | | | |
| | $I_O = 1.5A$ | 390 | | 600 | |
| Ground Current (Note 3) | $I_O = 750mA$, $V_{IN} = V_{OUT} + 1V$ | 12 | | 25 | mA |
| | $I_O = 1.5A$ | 45 | | | |
| IGNDDO Ground Pin Current at Dropout | $V_{IN} = 0.1V$ less than specified V_{OUT} $I_{OUT} = 10mA$ | 0.9 | | | mA |
| Current Limit | $V_{OUT} = 0.0V$ (Note 2) | 2.2 | 1.7 | | A |
| Output Noise Voltage (10Hz to 100kHz) $I_L = 100mA$ | $C_L = 10\mu F$ | 400 | | | μV_{RMS} |
| | $C_L = 33\mu F$ | 260 | | | |
| Reference Voltage | Adjustable version only | 1.240 | 1.228 1.215 | 1.252 1.265 | V |
| Reference Voltage | Adjustable version only (Note 8) | | 1.203 | 1.277 | |
| Adjust Pin Bias Current | | 40 | | 80 120 | nA |
| Reference Voltage Temperature Coefficient | (Note 4) | 13 | | | ppm/°C |
| Adjust Pin Bias Current Temperature Coefficient | | 0.1 | | | nA/°C |
| Flag Output (Error Comparator) SPX29151/53 | | | | | |
| Output Leakage Current | $V_{OH} = 16V$ | 0.1 | | 1.00 2.00 | UA |
| Output Low Voltage | Device set for 5V, $V_{IN} = 4.5V$, $I_{OL} = 250\mu A$ | 200 | | 300 400 | mV |

| PARAMETER | CONDITIONS | Typ | SPX29150/51 | | Units |
|---|---------------------------------|-----|-------------|------------|---------------|
| | | | Min | Max | |
| Upper Threshold Voltage | Device set for 5V (Note 5) | 60 | 40 25 | | mV |
| Lower Threshold Voltage | Device set for 5V (Note 5) | 75 | | 95 140 | mV |
| Hysteresis | Device set for 5V (Note 5) | 15 | | | mV |
| ENABLE input SPX29151/52 | | | | | |
| Input Logic Voltage Low (OFF) High (ON) | $V_{IN} < 10V$ | | 2.4V | 0.8 | V |
| Enable Input Pin Input Current | $V_{EN}=16V$ | 100 | | 600 750 | μA |
| | $V_{EN}=0.8V$ | | | 1 2 | μA |
| Regulator Output Current in Shutdown | (Note 6) | 10 | | 500 | μA |
| Thermal Resistance | TO-220 Junction to Case, at Tab | 3 | | | $^{\circ}C/W$ |
| | TO-220 Junction to Ambient | 30 | | | |
| | TO-263 Junction to Case, at Tab | 3 | | | |
| | TO-263 Junction to Ambient | 32 | | | |

NOTES:

- Note 1: Dropout voltage is defined as the input to output differential when the output voltage drops to 99% of its nominal value.
- Note 2: $V_{IN} = V_{OUT} (NOMINAL) + 1V$. For example, use $V_{IN} = 4.3V$ for a 3.3V regulator. Employ pulse-testing procedures to minimize temperature rise.
- Note 3: Ground pin current is the regulator quiescent current. The total current drawn from the source is the sum of the load current to the ground current.
- Note 4: Thermal regulation is defined as the change in the output voltage at a time T after a change in power dissipation is applied, excluding load or line regulation effects.
- Note 5: Comparator threshold is expressed in terms of a voltage differential at the Adjust terminal below the nominal reference voltage measured 6V input. To express these thresholds in terms of output voltage change, multiply the error amplifier gain = $V_{OUT}/V_{REF} = (R1 + R2)/R2$. For example, at a programmable output voltage of 5V, the Error output is guaranteed to go low when the output drops by $95mV \times 5V / 1.240V = 38mV$. Thresholds remain constant as a percent of V_{OUT} as V_{OUT} is varied, with the dropout warning occurring at typically 5% below nominal, 7.7% guaranteed.
- Note 6: $V_{EN} \leq 0.8V$ and $V_{IN} \leq 16V$, $V_{OUT} = 0$.
- Note 7: Maximum positive supply voltage of 20V must be of limited duration ($<100m_s$) $< 1\%$. The maximum continuous supply voltage is 16V.
- Note 8: $V_{REF} \leq V_{OUT} \leq (V_{IN}-1)$, $2.5V \leq V_{IN} \leq 16V$, $10mA \leq I_L \leq I_{FL}$, $T_J < T_{JMAX}$.

BLOCK DIAGRAM

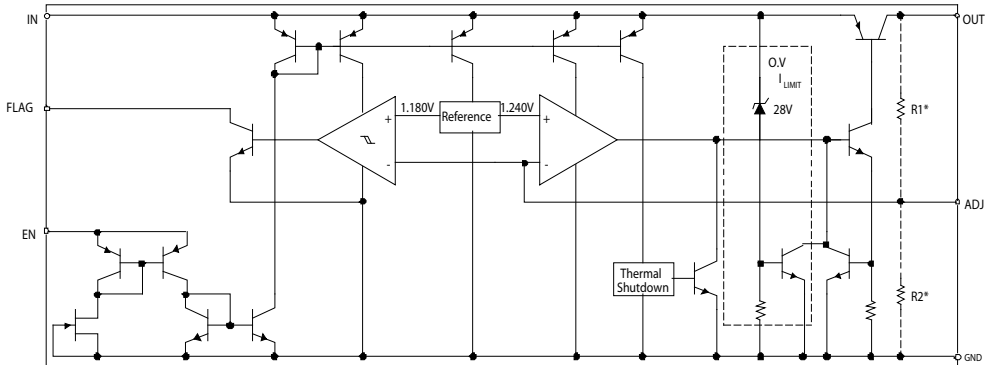

TYPICAL PERFORMANCE CHARACTERISTICS

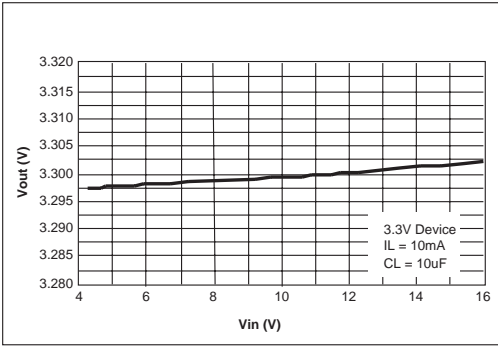

Figure 3. Line Regulation

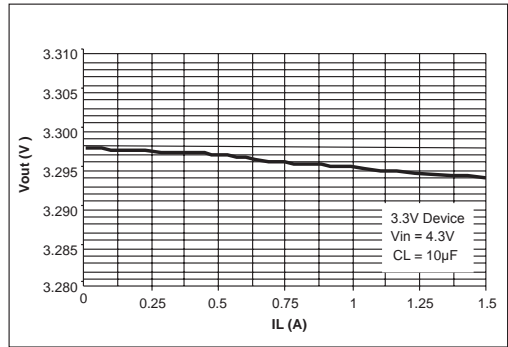

Figure 4. Load Regulation

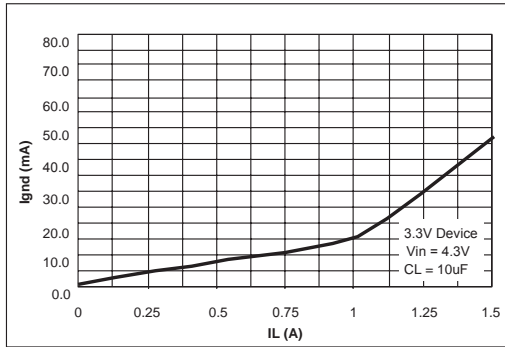

Figure 5. Ground Current vs Load Current

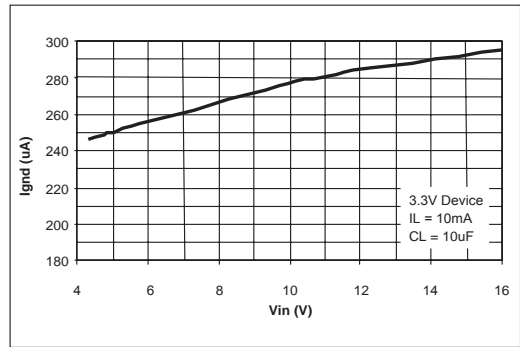

Figure 6. Ground Current vs Input Voltage

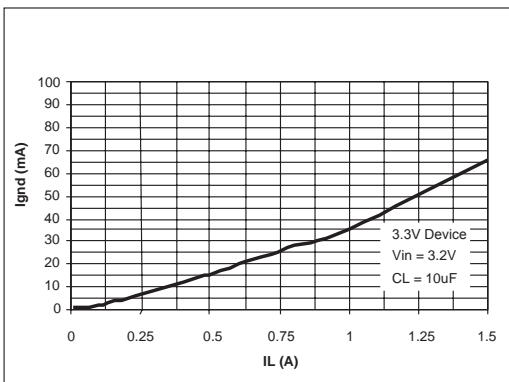

Figure 7. Ground Current vs Load Current in Dropout

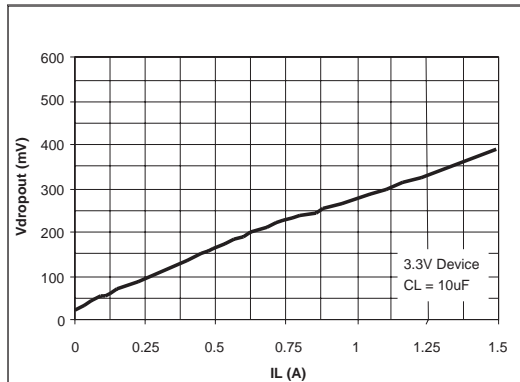

Figure 8. Dropout Voltage vs Load Current

TYPICAL PERFORMANCE CHARACTERISTICS

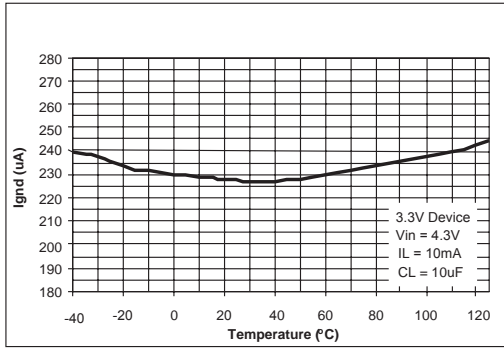

Figure 9. Ground Current vs Temperature at $I_{LOAD}=10mA$

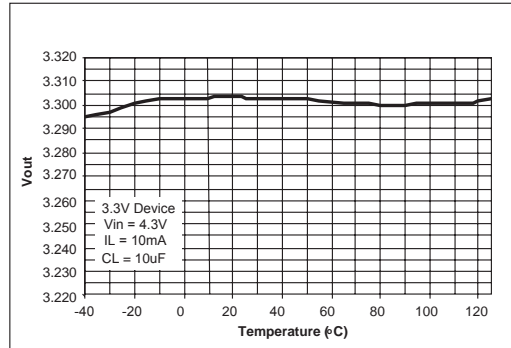

Figure 10. Output Voltage vs Temperature at $I_{LOAD}=10mA$

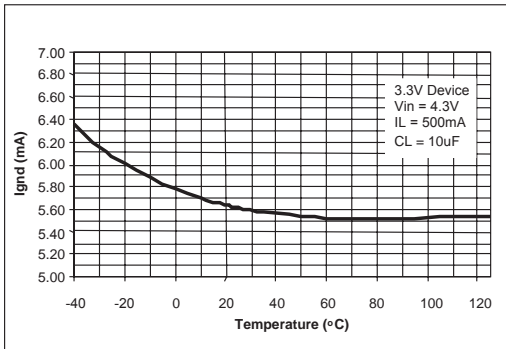

Figure 11. Ground Current vs Temperature at $I_{LOAD}=500mA$

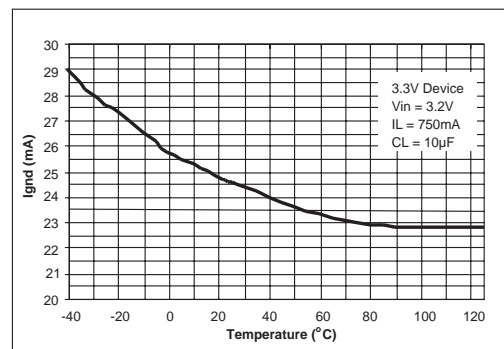

Figure 12. Ground Current vs Temperature in Dropout at $I_{LOAD}=750mA$

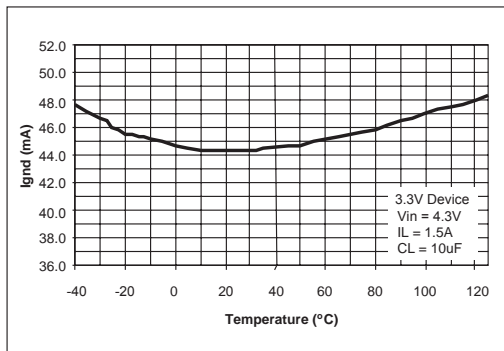

Figure 13. Ground Current vs Temperature at $I_{LOAD}=1.5A$

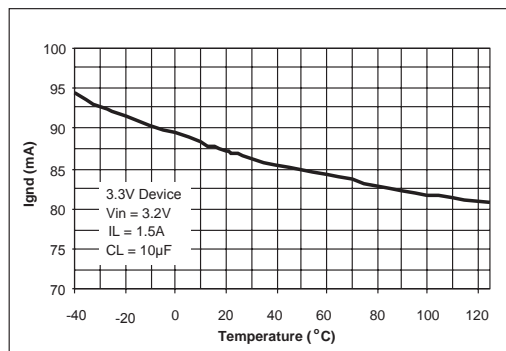

Figure 14. Ground Current vs Temperature in Dropout at $I_{LOAD}=1.5A$

TYPICAL PERFORMANCE CHARACTERISTICS

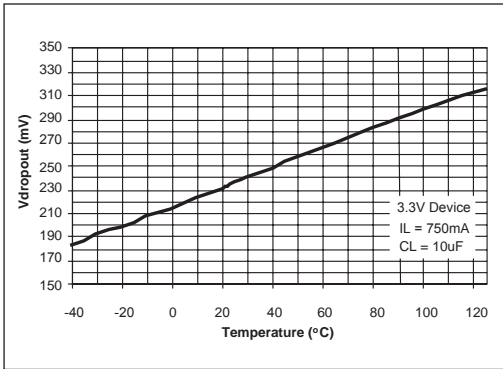

Figure 15. Dropout Voltage vs Temperature at $I_{LOAD}=750mA$

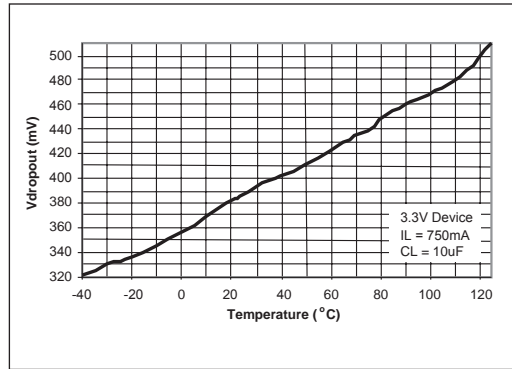

Figure 16. Dropout Voltage vs Temperature at $I_{LOAD}=1.5A$

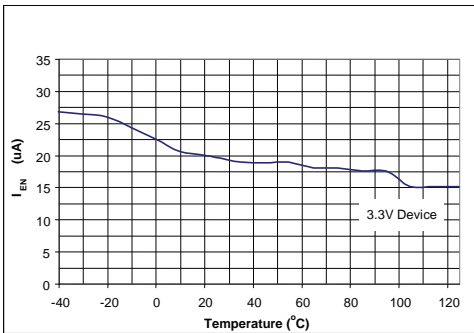

Figure 17. ENABLE Current vs Temperature at $V_{EN}=16V$

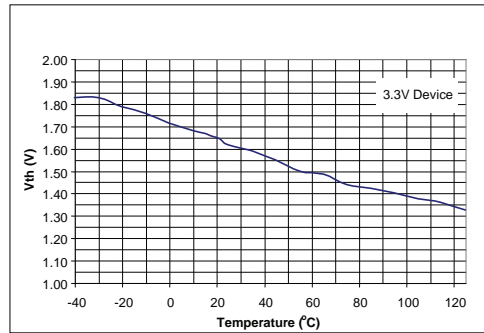

Figure 18. ENABLE Threshold vs Temperature

The SPX29150/51/52/53 incorporates protection against over-current faults, reversed load insertion, over temperature operation, and positive and negative transient voltages.

Thermal Considerations

Although the SPX29150/51/52/53 offers limiting circuitry for overload conditions, it is still necessary to insure that the maximum junction temperature is not exceeded in the application. Heat will flow through the lowest resistance path, the junction-to-case path. In order to insure the best thermal flow of the component, proper mounting is required. Consult the heatsink manufacturer for thermal resistance and heat sink design.

TO-220 Design Example:

Assume that $V_{IN} = 10V$, $V_{OUT} = 5V$, $I_{OUT} = 1.5A$, $T_A = 50^{\circ}C$, $\theta_{H} = 1^{\circ}C/W$, $\theta_{CH} = 2^{\circ}C/W$, and $\theta_{JC} = 3C^{\circ}/W$, where:

T_A = ambient temperature,

θ_{HA} = heatsink to ambient thermal resistance

θ_{CH} = case to heatsink thermal resistance

θ_{JC} = junction to case thermal resistance

The power calculated under these conditions is:

$$P_D = (V_{IN} - V_{OUT}) * I_{OUT} = 7.5W.$$

And the junction temperature is calculated as

$$T_J = T_A + P_D * (\theta_{HA} + \theta_{CH} + \theta_{JC}) \text{ or}$$

$$T_J = 50 + 7.5 * (1+2+3) = 95^{\circ}C$$

Reliable operation is insured.

Capacitor Requirements

The output capacitor is needed to insure stability and minimize the output noise. The value of the capacitor varies with the load. However, a minimum value of 10µF aluminum capacitor will guarantee stability over all load conditions. A tantalum capacitor is recommended if a faster load transient response is needed. If the power source has a high AC impedance, a 0.1µF ceramic capacitor between input & ground is recommended. The output capacitors maximum ESR value for stable operation is 0.33ohms.

Minimum Load Current

To ensure proper behavior of the regulator under light loads, a minimum load of 5mA for SPX29150/51/52/53 is required.

Typical Application Circuits

Figure 19 represents a typical fixed output regulator. Figure 20 represents an adjustable output regulator. The values of R1 and R2 set the output voltage value as follows: $V_{OUT} = V_{REF} * [1 + (R1/R2)]$. A minimum value of 10kΩ is recommended for R2 with a range between 10kΩ and 47kΩ.

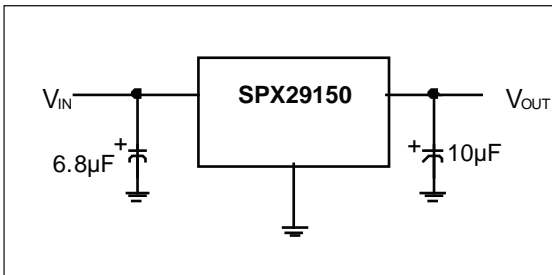

Figure 19. Fixed Output Linear Regulator

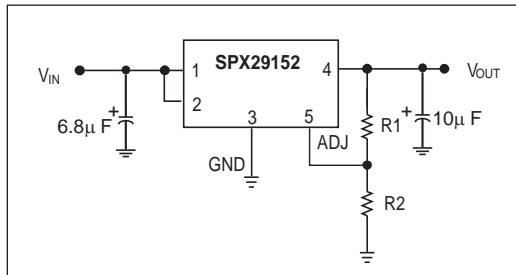
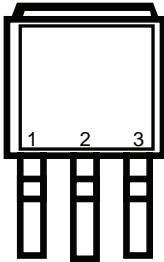

Figure 20. Adjustable Output Linear Regulator

TO-263-3 Package (T)



V_{IN} GND V_{OUT}

Front View

TO-263-5 Package (T5)

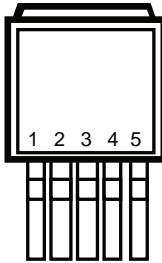

Top View

SPX29151

- 1) ENABLE
- 2) INPUT
- 3) GND
- 4) OUTPUT
- 5) FLAG

SPX29152

- 1) ENABLE
- 2) INPUT
- 3) GND
- 4) OUTPUT
- 5) ADJUST

SPX29153

- 1) FLAG
- 2) INPUT
- 3) GND
- 4) OUTPUT
- 5) ADJUST

*Tab is internally connected to GND

TO-220-3 Package (U)

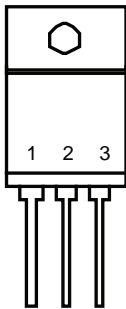

V_{IN} GND V_{OUT}

Front View

TO-220-5 Package (U5)

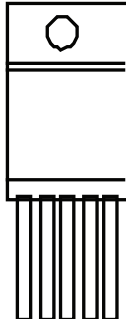

1 2 3 4 5

Top View

SPX29151

- 1) ENABLE
- 2) INPUT
- 3) GND
- 4) OUTPUT
- 5) FLAG

SPX29152

- 1) ENABLE
- 2) INPUT
- 3) GND
- 4) OUTPUT
- 5) ADJUST

SPX29153

- 1) FLAG
- 2) INPUT
- 3) GND
- 4) OUTPUT
- 5) ADJUST

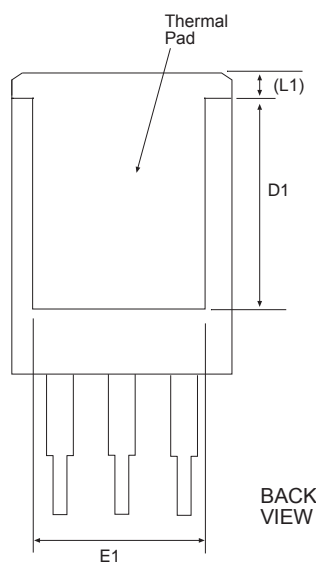
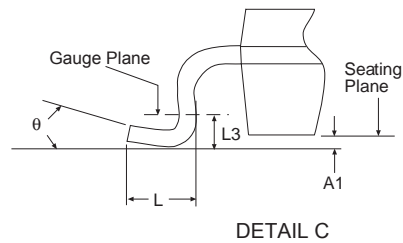
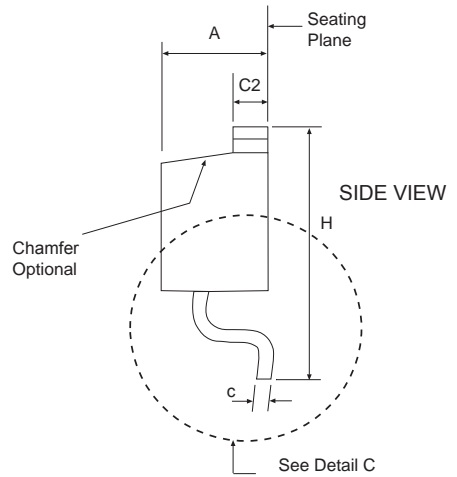
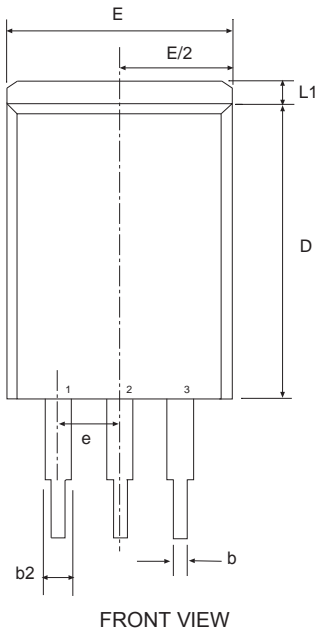

| 3 Pin TO-263 JEDEC TO-263 | | Variation AA | | | | |
|----------------------------|------------------------------|--------------|-------|--|-----|-------|
| SYMBOL | Inches Controlling Dimension | | | Millimeters Conversion Factor: 1 Inch = 25.40 mm | | |
| | MIN | NOM | MAX | MIN | NOM | MAX |
| A | 0.160 | - | 0.190 | 4.06 | - | 4.83 |
| A1 | 0.000 | - | 0.010 | 0.00 | - | 0.25 |
| b | 0.020 | - | 0.039 | 0.51 | - | 0.99 |
| b2 | 0.045 | - | 0.070 | 1.14 | - | 1.78 |
| c | 0.015 | - | 0.029 | 0.38 | - | 0.74 |
| c2 | 0.045 | - | 0.065 | 1.14 | - | 1.65 |
| D | 0.330 | - | 0.380 | 8.38 | - | 9.65 |
| D1 | 0.270 | - | - | 6.86 | - | - |
| E | 0.380 | - | 0.420 | 9.65 | - | 10.67 |
| E1 | 0.245 | - | - | 6.22 | - | - |
| e | .100 BSC | | | 2.54 BSC | | |
| H | 0.575 | - | 0.625 | 14.61 | - | 15.88 |
| L | 0.070 | - | 0.110 | 1.78 | - | 2.79 |
| L1 | - | - | 0.066 | - | - | 1.68 |
| L3 | .010 BSC | | | 0.25 BSC | | |
| Ø | 0" | - | 8" | 0" | - | 8" |
| EXAR Pkg Signoff Date/Rev: | | | | JL Aug5-05 / Rev A | | |

PACKAGE: 5 PIN TO-263

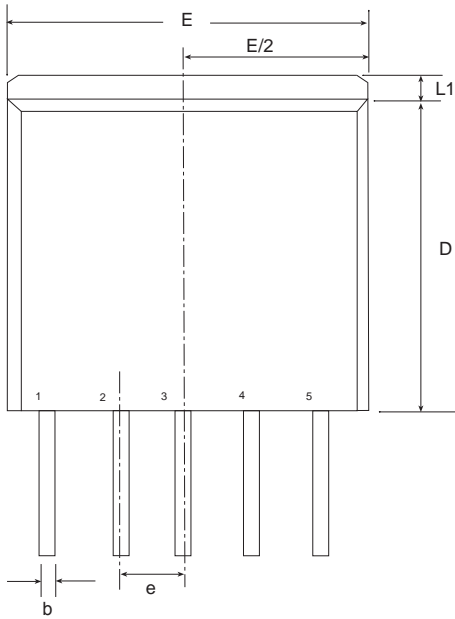

FRONT VIEW

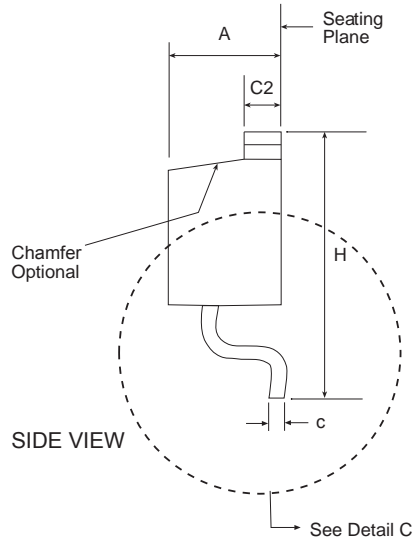

SIDE VIEW

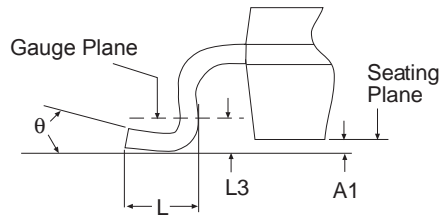

DETAIL C

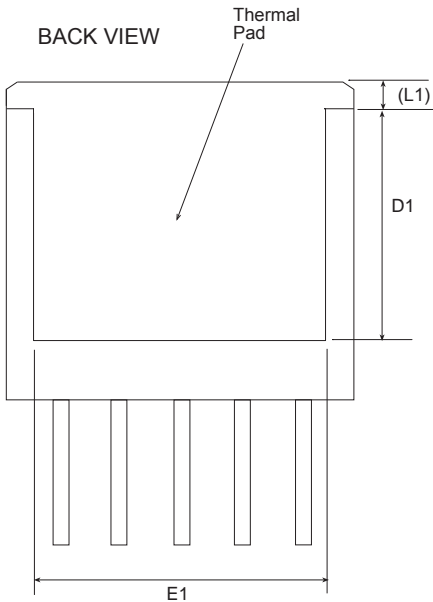

BACK VIEW

| 5 Pin TO-263 JEDEC TO-263 Variation BA | | | | | | |
|--|--|-----|-------|--|-----|-------|
| SYMBOL | Dimensions in Inches: Controlling Dimension | | | Dimensions in Millimeters Conversion Factor: 1 Inch = 25.40 mm | | |
| | MIN | NOM | MAX | MIN | NOM | MAX |
| A | 0.160 | - | 0.190 | 4.06 | - | 4.83 |
| A1 | 0.000 | - | 0.010 | 0.00 | - | 0.25 |
| b | 0.020 | - | 0.039 | 0.51 | - | 0.99 |
| c | 0.015 | - | 0.029 | 0.38 | - | 0.74 |
| c2 | 0.045 | - | 0.065 | 1.14 | - | 1.65 |
| D | 0.330 | - | 0.380 | 8.38 | - | 9.65 |
| D1 | 0.270 | - | - | 6.86 | - | - |
| E | 0.380 | - | 0.420 | 9.65 | - | 10.67 |
| E1 | 0.245 | - | - | 6.22 | - | - |
| e | .067 BSC | | | 1.702 BSC | | |
| H | 0.575 | - | 0.625 | 14.61 | - | 15.88 |
| L | 0.070 | - | 0.110 | 1.78 | - | 2.79 |
| L1 | - | - | 0.066 | - | - | 1.68 |
| L3 | .010 BSC | | | 0.254 BSC | | |
| θ | 0° | - | 8° | 0° | - | 8° |
| EXAR Pkg Signoff Date/Rev: | | | | JL Jun12-06 / Rev B | | |

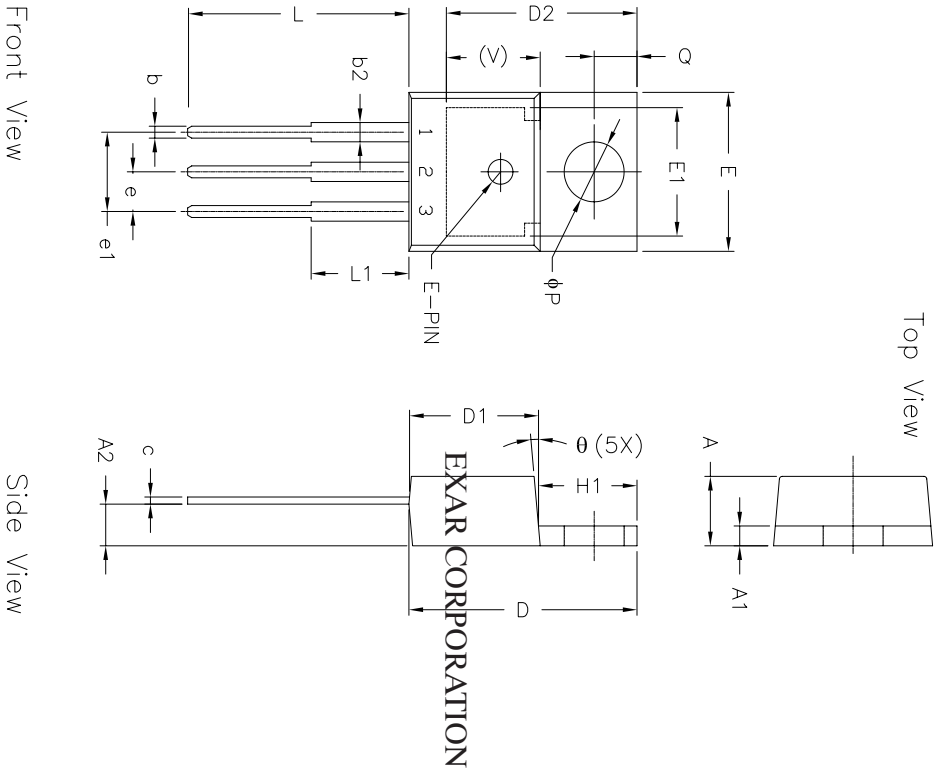

| REVISION HISTORY | | | |
|------------------|-----------------------------|----------|-------|
| REV | DESCRIPTION | DATE | APP'D |
| A | DRAWING ORIGINATION | 09/04/05 | JL |
| B | DRAWING FORMAT MODIFICATION | 05/25/06 | JL |

| SYMBOLS | DIMENSIONS IN INCH (Control Unit) | | DIMENSIONS IN MM (Reference Unit) | |
|---------|--------------------------------------|-------|--------------------------------------|-------|
| | MIN | MAX | MIN | MAX |
| A | 0.140 | 0.190 | 3.56 | 4.82 |
| A1 | 0.020 | 0.055 | 0.51 | 1.40 |
| A2 | 0.080 | 0.115 | 2.03 | 2.92 |
| b | 0.015 | 0.040 | 0.38 | 1.02 |
| c | 0.014 | 0.024 | 0.36 | 0.61 |
| D | 0.560 | 0.650 | 14.22 | 16.51 |
| D1 | 0.330 | 0.355 | 8.38 | 9.02 |
| D2 | 0.480 | 0.507 | 12.19 | 12.88 |
| E | 0.380 | 0.420 | 9.65 | 10.67 |
| E1 | 0.270 | 0.350 | 6.86 | 8.89 |
| e | 0.100 BSC | | 2.54 BSC | |
| e1 | 0.200 BSC | | 5.08 BSC | |
| H1 | 0.230 | 0.270 | 5.84 | 6.86 |
| L | 0.500 | 0.580 | 12.70 | 14.73 |
| L1 | — | 0.250 | — | 6.35 |
| P | 0.139 | 0.156 | 3.53 | 3.96 |
| Q | 0.103 | 0.113 | 2.62 | 2.87 |
| V | 0.240 REF | | 6.10 REF | |
| Ø | 3° | 7° | 3° | 7° |
| N | 3 | | 3 | |

* Refer to product datasheet for POD option being used

| | | | |
|---------------------|----------------|--------------|---------------|
| | | | |
| | | | |
| Packaging Approval: | | Drawing No: | |
| By: JL | Date: 05/25/06 | 3-PIN TO-220 | |
| | | Revision: B | Sheet: 1 OF 2 |

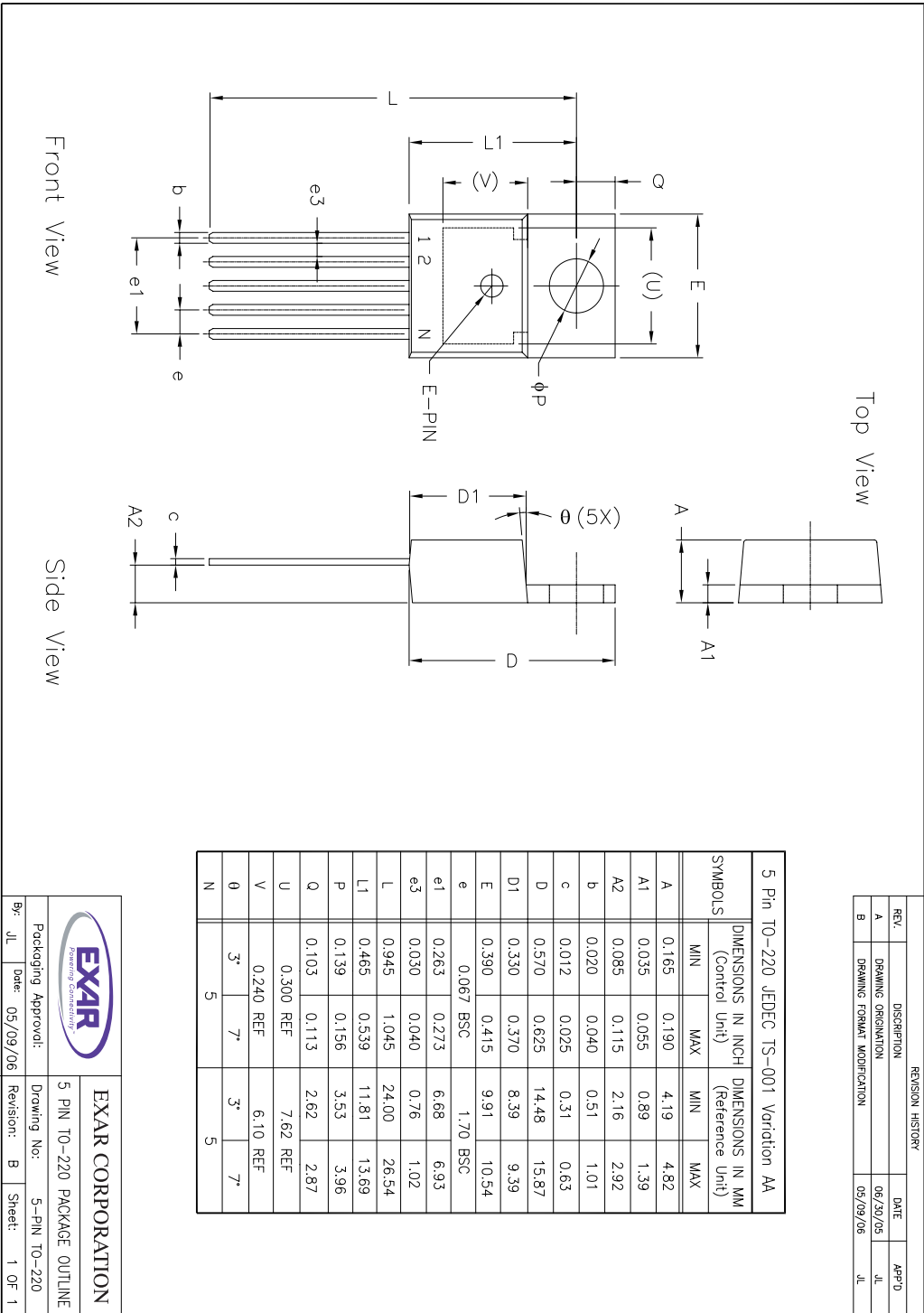

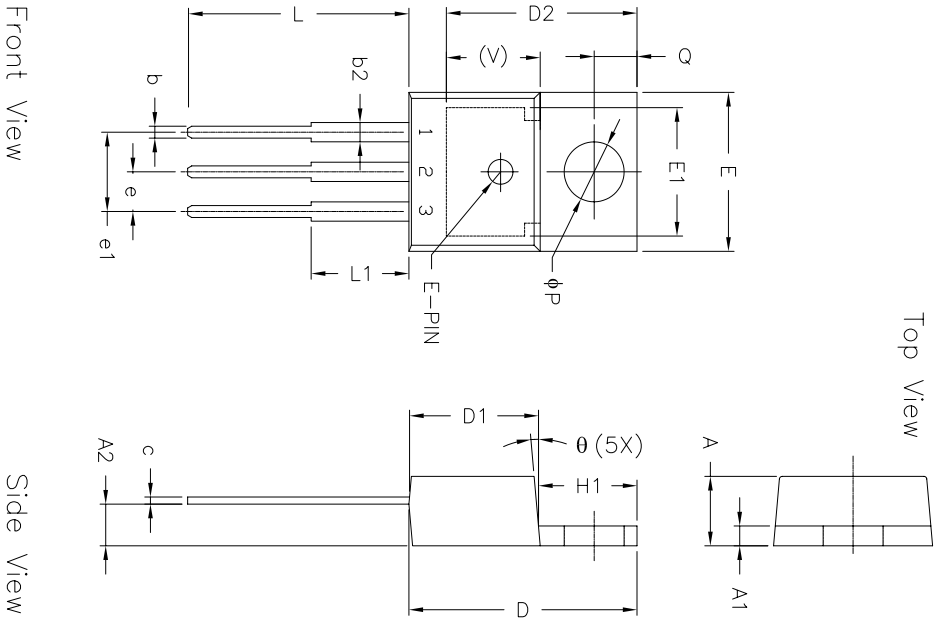

| REVISION HISTORY | | DATE | APP'D |
|------------------|-----------------------------|----------|-------|
| REV/ | DESCRIPTION | | |
| A | DRAWING ORIGINATOR | 09/04/05 | JL |
| B | DRAWING FORMAT MODIFICATION | 05/25/06 | JL |

| SYMBOLS | DIMENSIONS IN INCH (Control Unit) | | DIMENSIONS IN MM (Reference Unit) | |
|----------|--------------------------------------|-------|--------------------------------------|-------|
| | MIN | MAX | MIN | MAX |
| A | 0.140 | 0.190 | 3.56 | 4.82 |
| A1 | 0.020 | 0.055 | 0.51 | 1.40 |
| A2 | 0.080 | 0.115 | 2.03 | 2.92 |
| b | 0.015 | 0.040 | 0.38 | 1.02 |
| c | 0.014 | 0.024 | 0.36 | 0.61 |
| D | 0.560 | 0.650 | 14.22 | 16.51 |
| D1 | 0.330 | 0.355 | 8.38 | 9.02 |
| D2 | 0.480 | 0.507 | 12.19 | 12.88 |
| E | 0.380 | 0.420 | 9.65 | 10.67 |
| E1 | 0.270 | 0.350 | 6.86 | 8.89 |
| e | 0.100 BSC | | 2.54 BSC | |
| e1 | 0.200 BSC | | 5.08 BSC | |
| H1 | 0.230 | 0.270 | 5.84 | 6.86 |
| L | 0.500 | 0.580 | 12.70 | 14.73 |
| L1 | — | 0.250 | — | 6.35 |
| P | 0.139 | 0.156 | 3.53 | 3.96 |
| Q | 0.103 | 0.113 | 2.62 | 2.87 |
| V | 0.240 REF | | 6.10 REF | |
| θ | 3° | 7° | 3° | 7° |
| N | 3 | | 3 | |

* Refer to product datasheet for POD option being used

Front View



Side View

Top View







| | | | |
|---|----------------|--|---------------|
|  | | SIPLEX CORPORATION <small>Powering Connectivity™</small> | |
| | | | |
| Packaging Approval: | | Drawing No: | |
| By: JL | Date: 05/25/06 | Revision: B | Sheet: 1 OF 2 |

Looking for pricing, stock, or lifecycle information?

Click below to explore more details on WIN SOURCE:

-  [View SPX29151T5-L-1-8 on WIN SOURCE](#)
-  [MaxLinear Inc Information](#)

Optimize Your Supply Chain with WIN SOURCE Solutions

-  Global Sourcing Solution
-  Obsolete Management
-  Cost Control Management
-  Shortage Management
-  Alternative Solution
-  Excess Inventory Management