



**THE DATASHEET OF  
ADUM5000WARWZ-RL**



### FEATURES

*isoPower* integrated, isolated dc-to-dc converter

Regulated 3.3 V or 5 V output

Up to 400 mW output power

16-lead SOIC package with 7.6 mm creepage

High temperature operation: 105°C maximum

Thermal overload protection

[Safety and regulatory approvals](#)

UL recognition

2500 V rms for 1 minute per UL 1577

CSA Component Acceptance Notice #5A

VDE certificate of conformity (pending)

IEC 60747-5-2 (VDE 0884, Part 2)

$V_{IORM} = 560$  V peak

Qualified for automotive applications

### APPLICATIONS

Automotive battery monitor

RS-232/RS-422/RS-485 transceivers

Power supply startups and gate drives

Isolated sensor interfaces

### GENERAL DESCRIPTION

The ADuM5000W<sup>1</sup> is an isolated dc-to-dc converter based on the Analog Devices, Inc., *iCoupler*<sup>®</sup> technology. The dc-to-dc converter in this device provides regulated, isolated power in several combinations of input and output voltages as listed in Table 1.

The Analog Devices chip scale transformer, *iCoupler* technology, transfers isolated power in this dc-to-dc converter with up to 33% efficiency. The result is a small form factor, total isolation solution.

Higher output power levels are obtained by using the ADuM5000W to augment the power output of ADuM5401, ADuM5402, ADuM5403, ADuM5404, ADuM520x, and other ADuM5000W *iCouplers* with *isoPower*<sup>®</sup>.

### FUNCTIONAL BLOCK DIAGRAM

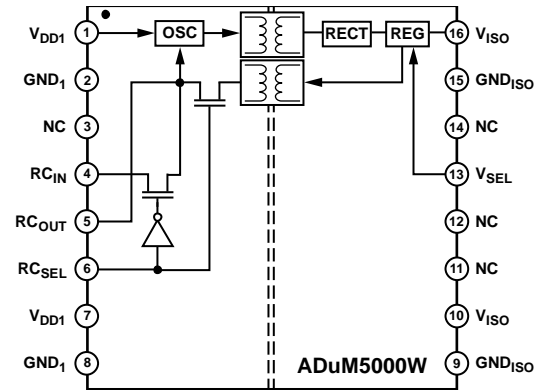

Figure 1.

*isoPower* uses high frequency switching elements to transfer power through its transformer. Special care must be taken during printed circuit board (PCB) layout to meet emissions standards. See the [AN-0971 Application Note](#) for board layout recommendations.

Table 1.

Input Voltage (V)	Output Voltage (V)	Output Power (mW)
5	5	400
5	3.3	330
3.3	3.3	132

<sup>1</sup> Protected by U.S. Patents 5,952,849; 6,873,065; 6,903,578; and 7,075,329.

## TABLE OF CONTENTS

Features .....	1	Absolute Maximum Ratings .....	7
Applications.....	1	ESD Caution.....	7
Functional Block Diagram .....	1	Pin Configuration and Function Descriptions.....	8
General Description .....	1	Typical Performance Characteristics .....	9
Revision History .....	2	Applications Information .....	11
Specifications.....	3	PCB Layout .....	11
Electrical Characteristics—5 V Primary Input Supply/5 V		Start-Up Behavior.....	11
Secondary Isolated Supply.....	3	EMI Considerations .....	12
Electrical Characteristics—3.3 V Primary Input Supply/3.3 V		Thermal Analysis .....	12
Secondary Isolated Supply.....	3	Current Limit and Thermal Overload Protection .....	12
Electrical Characteristics—5 V Primary Input Supply/3.3 V		Power Considerations .....	12
Secondary Isolated Supply.....	4	Increasing Available Power .....	13
Package Characteristics .....	5	Insulation Lifetime .....	14
Regulatory Information.....	5	Outline Dimensions .....	15
Insulation and Safety-Related Specifications.....	5	Ordering Guide .....	15
IEC 60747-5-2 (VDE 0884, Part 2):2003-01 Insulation		Automotive Products.....	15
Characteristics .....	6		
Recommended Operating Conditions .....	6		

## REVISION HISTORY

### 8/2016—Rev. 0 to Rev. A

Changes to Ordering Guide ..... 15

### 9/2012—Revision 0: Initial Version

## SPECIFICATIONS

### ELECTRICAL CHARACTERISTICS—5 V PRIMARY INPUT SUPPLY/5 V SECONDARY ISOLATED SUPPLY

$4.5\text{ V} \leq V_{DD1} \leq 5.5\text{ V}$ ,  $V_{SEL} = V_{ISO}$ ; each voltage is relative to its respective ground. All minimum/maximum specifications apply over the entire recommended operating range, unless otherwise noted. All typical specifications are at  $T_A = 25^\circ\text{C}$ ,  $V_{DD1} = 5.0\text{ V}$ ,  $V_{ISO} = 5.0\text{ V}$ , and  $V_{SEL} = V_{ISO}$ .

Table 2.

Parameter	Symbol	Min	Typ	Max	Unit	Test Conditions
DC-TO-DC CONVERTER POWER SUPPLY						
Setpoint	$V_{ISO}$	4.7	5.0	5.4	V	$I_{ISO} = 0\text{ mA}$
Line Regulation	$V_{ISO(LINE)}$		1		mV/V	$I_{ISO} = 40\text{ mA}$ , $V_{DD1} = 4.5\text{ V to }5.5\text{ V}$
Load Regulation	$V_{ISO(LOAD)}$		1	5	%	$I_{ISO} = 8\text{ mA to }72\text{ mA}$
Output Ripple	$V_{ISO(RIP)}$		75		mV p-p	20 MHz bandwidth, $C_{BO} = 0.1\text{ }\mu\text{F}  10\text{ }\mu\text{F}$ , $I_{ISO} = 72\text{ mA}$
Output Noise	$V_{ISO(N)}$		200		mV p-p	$C_{BO} = 0.1\text{ }\mu\text{F}  10\text{ }\mu\text{F}$ , $I_{ISO} = 72\text{ mA}$
Switching Frequency	$f_{OSC}$		180		MHz	
PWM Frequency	$f_{PWM}$		625		kHz	
$I_{DD1}$ Supply Current, Full $V_{ISO}$ Load	$I_{DD1(MAX)}$		290		mA	$I_{ISO} = 80\text{ mA}$
Maximum Output Supply Current	$I_{ISO(MAX)}$	80			mA	$V_{ISO} > 4.5\text{ V}$
Efficiency at Maximum Output Supply Current			34		%	$I_{ISO} = 80\text{ mA}$
$I_{DD1}$ Supply Current, No $V_{ISO}$ Load	$I_{DD1(Q)}$		4	15	mA	$I_{ISO} = 0\text{ mA}$
Undervoltage Lockout, $V_{DD1}$ and $V_{ISO}$ Supply						
Positive Going Threshold	$V_{UV+}$		2.7		V	
Negative Going Threshold	$V_{UV-}$		2.4		V	
Hysteresis	$V_{UVH}$		0.3		V	

### ELECTRICAL CHARACTERISTICS—3.3 V PRIMARY INPUT SUPPLY/3.3 V SECONDARY ISOLATED SUPPLY

$3.0\text{ V} \leq V_{DD1} \leq 3.6\text{ V}$ ,  $V_{SEL} = \text{GND}_{ISO}$ ; each voltage is relative to its respective ground. All minimum/maximum specifications apply over the entire recommended operating range, unless otherwise noted. All typical specifications are at  $T_A = 25^\circ\text{C}$ ,  $V_{DD1} = 3.3\text{ V}$ ,  $V_{ISO} = 3.3\text{ V}$ , and  $V_{SEL} = \text{GND}_{ISO}$ .

Table 3.

Parameter	Symbol	Min	Typ	Max	Unit	Test Conditions
DC-TO-DC CONVERTER POWER SUPPLY						
Setpoint	$V_{ISO}$	3.0	3.3	3.6	V	$I_{ISO} = 0\text{ mA}$
Line Regulation	$V_{ISO(LINE)}$		1		mV/V	$I_{ISO} = 20\text{ mA}$ , $V_{DD1} = 3.0\text{ V to }3.6\text{ V}$
Load Regulation	$V_{ISO(LOAD)}$		1	5	%	$I_{ISO} = 4\text{ mA to }36\text{ mA}$
Output Ripple	$V_{ISO(RIP)}$		50		mV p-p	20 MHz bandwidth, $C_{BO} = 0.1\text{ }\mu\text{F}  10\text{ }\mu\text{F}$ , $I_{ISO} = 36\text{ mA}$
Output Noise	$V_{ISO(N)}$		130		mV p-p	$C_{BO} = 0.1\text{ }\mu\text{F}  10\text{ }\mu\text{F}$ , $I_{ISO} = 36\text{ mA}$
Switching Frequency	$f_{OSC}$		180		MHz	
PWM Frequency	$f_{PWM}$		625		kHz	
$I_{DD1}$ Supply Current, Full $V_{ISO}$ Load	$I_{DD1(MAX)}$		175		mA	$I_{ISO} = 40\text{ mA}$
Maximum Output Supply Current	$I_{ISO(MAX)}$	40			mA	$V_{ISO} > 3.0\text{ V}$
Efficiency at Maximum Output Supply Current			35		%	$I_{ISO} = 40\text{ mA}$
$I_{DD1}$ Supply Current, No $V_{ISO}$ Load	$I_{DD1(Q)}$		3	12	mA	$I_{ISO} = 0\text{ mA}$
Undervoltage Lockout, $V_{DD1}$ and $V_{ISO}$ Supply						
Positive Going Threshold	$V_{UV+}$		2.7		V	
Negative Going Threshold	$V_{UV-}$		2.4		V	
Hysteresis	$V_{UVH}$		0.3		V	

**ELECTRICAL CHARACTERISTICS—5 V PRIMARY INPUT SUPPLY/3.3 V SECONDARY ISOLATED SUPPLY**

$4.5\text{ V} \leq V_{DD1} \leq 5.5\text{ V}$ ,  $V_{SEL} = \text{GND}_{ISO}$ , each voltage is relative to its respective ground. All minimum/maximum specifications apply over the entire recommended operating range, unless otherwise noted. All typical specifications are at  $T_A = 25^\circ\text{C}$ ,  $V_{DD1} = 5.0\text{ V}$ ,  $V_{ISO} = 3.3\text{ V}$ , and  $V_{SEL} = \text{GND}_{ISO}$ .

**Table 4.**

Parameter	Symbol	Min	Typ	Max	Unit	Test Conditions
<b>DC-TO-DC CONVERTER POWER SUPPLY</b>						
Setpoint	$V_{ISO}$	3.0	3.3	3.6	V	$I_{ISO} = 0\text{ mA}$
Line Regulation	$V_{ISO(LINE)}$		1		mV/V	$I_{ISO} = 50\text{ mA}$ , $V_{DD1} = 4.5\text{ V to }5.5\text{ V}$
Load Regulation	$V_{ISO(LOAD)}$		1	5	%	$I_{ISO} = 10\text{ mA to }100\text{ mA}$
Output Ripple	$V_{ISO(RIP)}$		50		mV p-p	20 MHz bandwidth, $C_{BO} = 0.1\ \mu\text{F}  10\ \mu\text{F}$ , $I_{ISO} = 90\text{ mA}$
Output Noise	$V_{ISO(N)}$		130		mV p-p	$C_{BO} = 0.1\ \mu\text{F}  10\ \mu\text{F}$ , $I_{ISO} = 90\text{ mA}$
Switching Frequency	$f_{OSC}$		180		MHz	
PWM Frequency	$f_{PWM}$		625		kHz	
$I_{DD1}$ Supply Current, Full $V_{ISO}$ Load	$I_{DD1(MAX)}$		250		mA	$I_{ISO} = 100\text{ mA}$
Maximum Output Supply Current	$I_{ISO(MAX)}$	100			mA	$V_{ISO} > 3.0\text{ V}$
Efficiency at Maximum Output Supply Current			28		%	$I_{ISO} = 100\text{ mA}$
$I_{DD1}$ Supply Current, No $V_{ISO}$ Load	$I_{DD1(Q)}$		3	12	mA	$I_{ISO} = 0\text{ mA}$
<b>Undervoltage Lockout, <math>V_{DD1}</math> and <math>V_{ISO}</math> Supply</b>						
Positive Going Threshold	$V_{UV+}$		2.7		V	
Negative Going Threshold	$V_{UV-}$		2.4		V	
Hysteresis	$V_{UVH}$		0.3		V	

**PACKAGE CHARACTERISTICS**

Table 5.

Parameter	Symbol	Min	Typ	Max	Unit	Test Conditions
<b>RESISTANCE AND CAPACITANCE</b>						
Resistance (Input-to-Output) <sup>1</sup>	R <sub>I-O</sub>		10 <sup>12</sup>		Ω	f = 1 MHz
Capacitance (Input-to-Output) <sup>1</sup>	C <sub>I-O</sub>		2.2		pF	
Input Capacitance <sup>2</sup>	C <sub>I</sub>		4.0		pF	
IC Junction-to-Ambient Thermal Resistance	θ <sub>JA</sub>		45		°C/W	Thermocouple is located at the center of the package underside; test conducted on a 4-layer board with thin traces <sup>3</sup>
<b>THERMAL SHUTDOWN</b>						
Thermal Shutdown Threshold	T <sub>SD</sub>		150		°C	T <sub>J</sub> rising
Thermal Shutdown Hysteresis	T <sub>SD-HYS</sub>		20		°C	

<sup>1</sup> This device is considered a 2-terminal device; Pin 1 through Pin 8 are shorted together, and Pin 9 through Pin 16 are shorted together.

<sup>2</sup> Input capacitance is from any input data pin to ground.

<sup>3</sup> Refer to the Power Considerations section for thermal model definitions.

**REGULATORY INFORMATION**

The ADuM5000W is approved by the organizations listed in Table 6. Refer to Table 11 and the Insulation Lifetime section for more information about recommended maximum working voltages for specific cross isolation waveforms and insulation levels.

Table 6.

UL	CSA	VDE (Pending)
Recognized under 1577 component recognition program <sup>1</sup>	Approved under CSA Component Acceptance Notice #5A	Certified according to IEC 60747-5-2 (VDE 0884, Part 2):2003-01 <sup>2</sup>
Single protection, 2500 V rms isolation voltage	Testing was conducted per CSA 60950-1-07 and IEC 60950-1, 2nd Edition at 2.5 kV rated voltage Basic insulation at 400 V rms (566 V peak) working voltage Reinforced insulation at 250 V rms (353 V peak) working voltage	Basic insulation, 560 V peak
File E214100	File 205078	File 2471900-4880-0001

<sup>1</sup> In accordance with UL 1577, each ADuM5000W is proof tested by applying an insulation test voltage ≥ 3000 V rms for 1 sec (current leakage detection limit = 5 μA).

<sup>2</sup> In accordance with IEC 60747-5-2 (VDE 0884, Part 2):2003-01, each ADuM5000W is proof tested by applying an insulation test voltage ≥ 1050 V peak for 1 sec (partial discharge detection limit = 5 pC). The asterisk (\*) marking branded on the component designates IEC 60747-5-2 (VDE 0884, Part 2):2003-01.

**INSULATION AND SAFETY-RELATED SPECIFICATIONS**

Table 7.

Parameter	Symbol	Value	Unit	Conditions
Rated Dielectric Insulation Voltage		2500	V rms	1-minute duration
Minimum External Air Gap (Clearance)	L(I01)	8.0	mm	Measured from input terminals to output terminals, shortest distance through air
Minimum External Tracking (Creepage)	L(I02)	7.6	mm	Measured from input terminals to output terminals, shortest distance path along body
Minimum Internal Distance (Internal Clearance)		0.017 min	mm	Distance through the insulation
Tracking Resistance (Comparative Tracking Index) Isolation Group	CTI	>175 IIIa	V	DIN IEC 112/VDE 0303 Part 1 Material Group (DIN VDE 0110, 1/89, Table 1)

**IEC 60747-5-2 (VDE 0884, PART 2):2003-01 INSULATION CHARACTERISTICS**

This power module is suitable for reinforced electrical isolation only within the safety limit data. Maintenance of the safety data is ensured by protective circuits. The asterisk (\*) marking branded on the component designates IEC 60747-5-2 (VDE 0884, Part 2):2003-01 approval.

**Table 8.**

Description	Conditions	Symbol	Characteristic	Unit
Installation Classification per DIN VDE 0110 For Rated Mains Voltage ≤ 150 V rms For Rated Mains Voltage ≤ 300 V rms For Rated Mains Voltage ≤ 400 V rms Climatic Classification Pollution Degree per DIN VDE 0110, Table 1			I to IV I to III I to II 40/105/21 2	
Maximum Working Insulation Voltage	$V_{IORM} \times 1.875 = V_{pd(m)}$ , 100% production test, $t_{ini} = t_m = 1$ sec, partial discharge < 5 pC	$V_{IORM}$	560	V peak
Input-to-Output Test Voltage, Method b1		$V_{pd(m)}$	1050	V peak
Input-to-Output Test Voltage, Method a	$V_{IORM} \times 1.5 = V_{pd(m)}$ , $t_{ini} = 60$ sec, $t_m = 10$ sec, partial discharge < 5 pC	$V_{pd(m)}$		
After Environmental Tests Subgroup 1			896	V peak
After Input and/or Safety Test Subgroup 2 and Subgroup 3	$V_{IORM} \times 1.2 = V_{pd(m)}$ , $t_{ini} = 60$ sec, $t_m = 10$ sec, partial discharge < 5 pC	$V_{pd(m)}$	672	V peak
Highest Allowable Overvoltage		$V_{IOTM}$	4000	V peak
Surge Isolation Voltage	$V_{PEAK} = 10$ kV, 1.2 μs rise time, 50 μs, 50% fall time	$V_{IOSM}$	4000	V peak
Safety-Limiting Values	Maximum value allowed in the event of a failure (see Figure 2)			
Maximum Junction Temperature		$T_s$	150	°C
Total Power Dissipation @ 25°C		$P_s$	2.78	W
Insulation Resistance at $T_s$	$V_{IO} = 500$ V	$R_s$	>10 <sup>9</sup>	Ω

**Thermal Derating Curve**

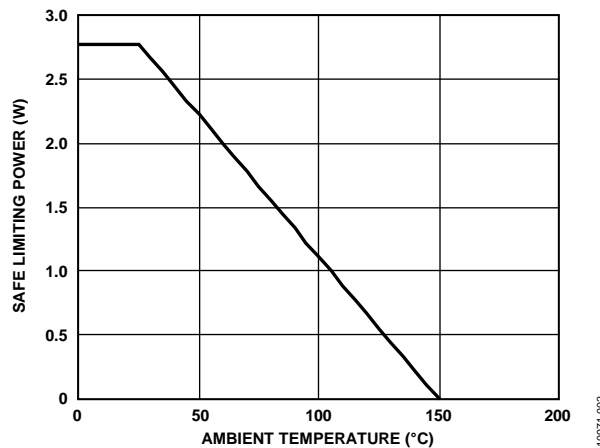

Figure 2. Thermal Derating Curve, Dependence of Safety-Limiting Values on Case Temperature, per DIN EN 60747-5-2

**RECOMMENDED OPERATING CONDITIONS**

**Table 9.**

Parameter	Symbol	Min	Max	Unit	Comments
TEMPERATURE <sup>1</sup>					
Operating Temperature	$T_A$	-40	+105	°C	
SUPPLY VOLTAGES <sup>2</sup>					Each voltage is relative to its respective ground
$V_{DD1}$ at $V_{SEL} = 0$ V	$V_{DD1}$	2.7	5.5	V	
$V_{DD1}$ at $V_{SEL} = 5$ V	$V_{DD1}$	4.5	5.5	V	

<sup>1</sup> Operation at 105°C requires reduction of the maximum load current as specified in Table 10.

<sup>2</sup> Each voltage is relative to its respective ground.

## ABSOLUTE MAXIMUM RATINGS

Ambient temperature = 25°C, unless otherwise noted.

Table 10.

Parameter	Rating
Storage Temperature ( $T_{ST}$ )	-55°C to +150°C
Ambient Operating Temperature ( $T_A$ )	-40°C to +105°C
Supply Voltages ( $V_{DDX}$ , $V_{ISO}$ ) <sup>1</sup>	-0.5 V to +7.0 V
Input Voltage ( $RC_{SEL}$ , $RC_{IN}$ , $V_{SEL}$ ) <sup>1,2</sup>	-0.5 V to $V_{DDI} + 0.5$ V
Output Voltage ( $RC_{OUT}$ ) <sup>1,2</sup>	-0.5 V to $V_{DDO} + 0.5$ V
Average Total Output Current <sup>3</sup> $I_{ISO}$	100 mA
Common-Mode Transients <sup>4</sup>	-100 kV/ $\mu$ s to +100 kV/ $\mu$ s

<sup>1</sup> Each voltage is relative to its respective ground.

<sup>2</sup>  $V_{DDI}$  and  $V_{DDO}$  refer to the supply voltages on the input and output sides of a given channel, respectively. See the PCB Layout section.

<sup>3</sup> See Figure 2 for maximum rated current values for various temperatures.

<sup>4</sup> Refers to common-mode transients across the isolation barrier. Common-mode transients exceeding the absolute maximum ratings may cause latch-up or permanent damage.

Stresses at or above those listed under Absolute Maximum Ratings may cause permanent damage to the product. This is a stress rating only; functional operation of the product at these or any other conditions above those indicated in the operational section of this specification is not implied. Operation beyond the maximum operating conditions for extended periods may affect product reliability.

Table 11. Maximum Continuous Working Voltage<sup>1</sup>

Parameter	Max	Unit	Reference Standard
AC Voltage			
Bipolar Waveform	424	V peak	50-year minimum lifetime
Unipolar Waveform			
Basic Insulation	600	V peak	Maximum approved working voltage per IEC 60950-1
Reinforced Insulation	353	V peak	Maximum approved working voltage per IEC 60950-1
DC Voltage			
Basic Insulation	600	V peak	Maximum approved working voltage per IEC 60950-1
Reinforced Insulation	353	V peak	Maximum approved working voltage per IEC 60950-1

<sup>1</sup> Refers to continuous voltage magnitude imposed across the isolation barrier. See the Insulation Lifetime section for more details.

### ESD CAUTION



**ESD (electrostatic discharge) sensitive device.** Charged devices and circuit boards can discharge without detection. Although this product features patented or proprietary protection circuitry, damage may occur on devices subjected to high energy ESD. Therefore, proper ESD precautions should be taken to avoid performance degradation or loss of functionality.

## PIN CONFIGURATION AND FUNCTION DESCRIPTIONS

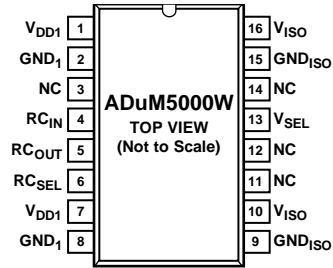

NOTES  
1. NC = NO INTERNAL CONNECTION.

Figure 3. Pin Configuration

10971-003

Table 12. Pin Function Descriptions

Pin No.	Mnemonic	Description
1, 7	V <sub>DD1</sub>	Primary Supply Voltage 3.0 V to 5.5 V. Pin 1 and Pin 7 are internally connected to each other, and it is recommended that both pins be externally connected to a common power source.
2, 8	GND <sub>1</sub>	Ground 1. Ground reference for the primary side of the converter. Pin 2 and Pin 8 are internally connected to each other, and it is recommended that both pins be connected to a common ground.
3, 11, 12, 14	NC	No Internal Connection.
4	RC <sub>IN</sub>	Regulation Control Input. In slave power configuration (RC <sub>SEL</sub> = low), this pin is connected to the RC <sub>OUT</sub> pin of a master <i>isoPower</i> device, or tied low to disable the converter. In master/standalone mode (RC <sub>SEL</sub> = high), this pin has no function. This pin is weakly pulled to low. In noisy environments, it should be tied to low or to a PWM control source. Note that this pin must not be tied high if RC <sub>SEL</sub> is low; this combination causes excessive voltage on the secondary side of the converter, damaging the ADuM5000W and possibly the devices that it powers.
5	RC <sub>OUT</sub>	Regulation Control Output. In master power configuration, this pin is connected to the RC <sub>IN</sub> pin of a slave <i>isoPower</i> device to allow the ADuM5000W to regulate additional devices.
6	RC <sub>SEL</sub>	Control Input. Sets either self-regulation/master mode (RC <sub>SEL</sub> high) or slave mode (RC <sub>SEL</sub> low). This pin is weakly pulled to the high state. In noisy environments, tie this pin either high or low.
9, 15	GND <sub>ISO</sub>	Ground Reference for the Secondary Side of the Converter. Pin 9 and Pin 15 are internally connected to each other, and it is recommended that both pins be connected to a common ground.
10, 16	V <sub>ISO</sub>	Secondary Supply Voltage Output for External Loads, 3.3 V (V <sub>SEL</sub> low) or 5.0 V (V <sub>SEL</sub> high). 5.0 V output functionality is not guaranteed for a 3.3 V primary supply input. Pin 10 and Pin 16 are internally connected to each other and connecting both externally is recommended.
13	V <sub>SEL</sub>	Output Voltage Selection. When V <sub>SEL</sub> = V <sub>ISO</sub> , the V <sub>ISO</sub> setpoint is 5.0 V. When V <sub>SEL</sub> = GND <sub>ISO</sub> , the V <sub>ISO</sub> setpoint is 3.3 V. This pin is weakly pulled to high. In noisy environments, tie this pin either high or low. In slave regulation mode, this pin has no function.

Table 13. Truth Table (Positive Logic)<sup>1</sup>

RC <sub>SEL</sub> Input	RC <sub>IN</sub> Input	RC <sub>OUT</sub> Output	V <sub>SEL</sub> Input	V <sub>DD1</sub> Input	V <sub>ISO</sub> Output	Operation
H	X	PWM <sup>2</sup>	H	5.0 V	5.0 V	Master mode operation, self regulating.
H	X	PWM <sup>2</sup>	L	5.0 V	3.3 V	Master mode operation, self regulating.
H	X	PWM <sup>2</sup>	H	3.3 V	5.0 V	This configuration is not recommended due to poor efficiency.
H	X	PWM <sup>2</sup>	L	3.3 V	3.3 V	Master mode operation, self regulating.
L	RC <sub>OUT(EXT)</sub>	RC <sub>IN</sub>	X	X <sup>3</sup>	X	Slave mode, RC <sub>OUT(EXT)</sub> supplied by a master <i>isoPower</i> device.
L	L	L	X	X	0 V	Low power mode, converter disabled.
L	H	H	X	X	X	Note that this combination of RC <sub>IN</sub> and RC <sub>SEL</sub> is prohibited. Damage occurs on the secondary side of the converter due to excess output voltage at V <sub>ISO</sub> . RC <sub>IN</sub> must be low, or it must be connected to a PWM signal from a master <i>isoPower</i> part.

<sup>1</sup> X = don't care.<sup>2</sup> PWM refers to the regulation control signal. This signal is derived from the secondary side regulator or from the RC<sub>IN</sub> input, depending on the value of RC<sub>SEL</sub>.<sup>3</sup> V<sub>DD1</sub> must be common between all *isoPower* devices being regulated by a master *isoPower* part.

### TYPICAL PERFORMANCE CHARACTERISTICS

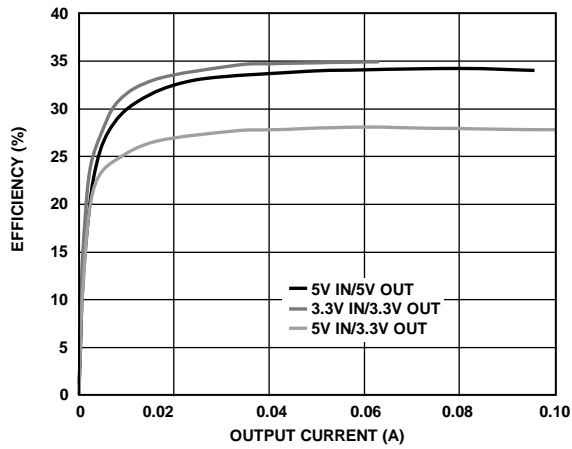

Figure 4. Typical Power Supply Efficiency in All Supported Power Configurations

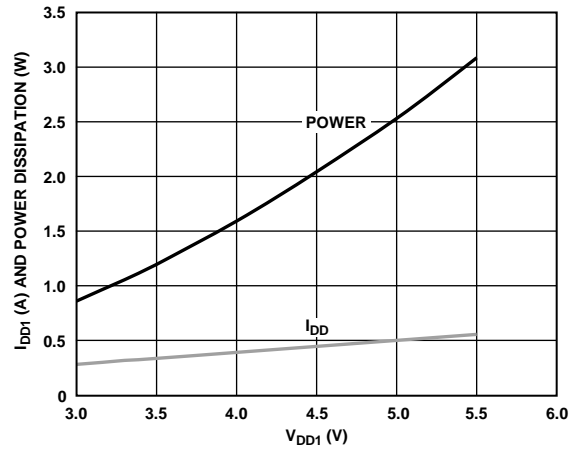

Figure 7. Typical Short-Circuit Input Current and Power vs.  $V_{DD1}$  Supply Voltage

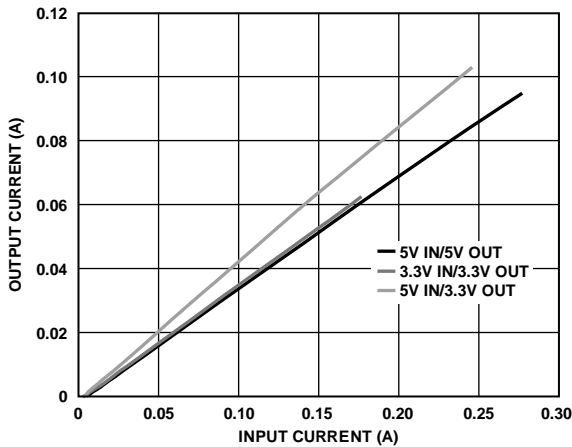

Figure 5. Typical Isolated Output Supply Current vs. External Load in All Supported Power Configurations

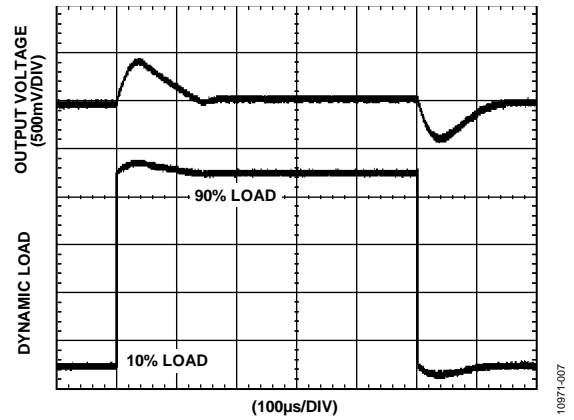

Figure 8. Typical  $V_{ISO}$  Transient Load Response, 5 V Output, 10% to 90% Load Step

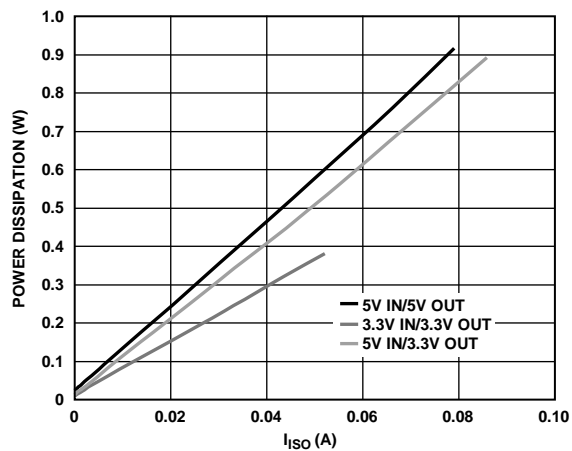

Figure 6. Typical Total Power Dissipation vs. Isolated Output Supply Current in All Supported Power Configurations

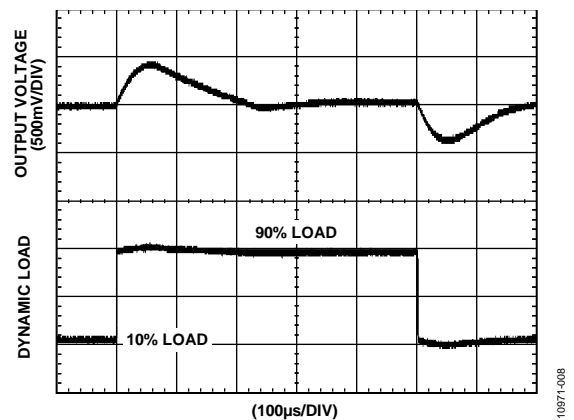

Figure 9. Typical  $V_{ISO}$  Transient Load Response, 3 V Output, 10% to 90% Load Step

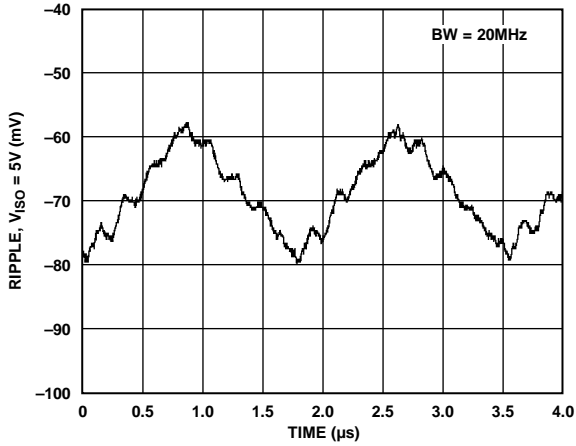

Figure 10. Typical Output Voltage Ripple at 90% Load,  $V_{ISO} = 5\text{ V}$

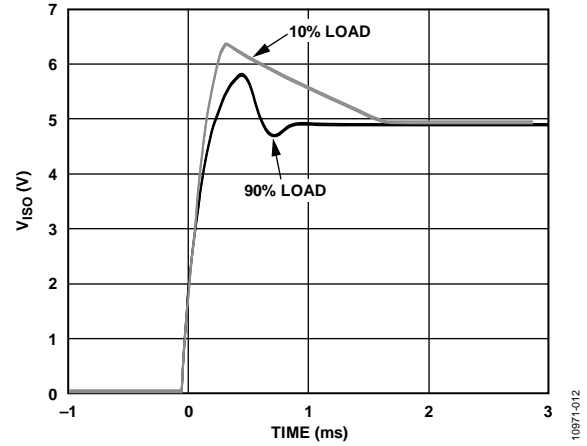

Figure 12. Typical Output Voltage Start-Up Transient at 10% and 90% Load,  $V_{ISO} = 5\text{ V}$

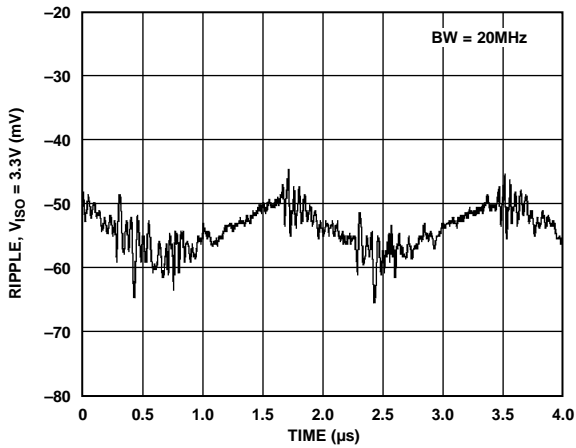

Figure 11. Typical Output Voltage Ripple at 90% Load,  $V_{ISO} = 3.3\text{ V}$

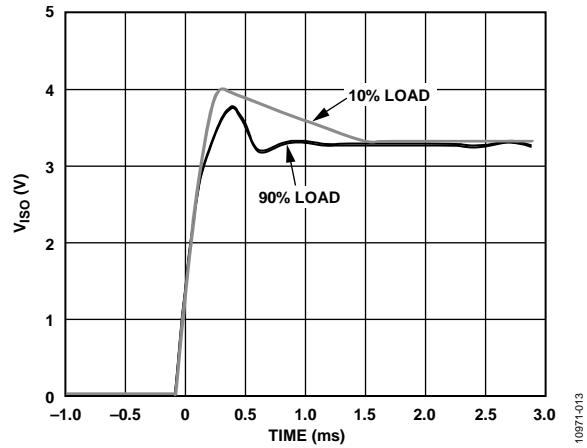

Figure 13. Typical Output Voltage Start-Up Transient at 10% and 90% Load,  $V_{ISO} = 3.3\text{ V}$

## APPLICATIONS INFORMATION

The dc-to-dc converter section of the [ADuM5000W](#) works on principles that are common to most switching power supplies. It has a secondary side controller architecture with isolated pulse-width modulation (PWM) feedback.  $V_{DD1}$  power is supplied to an oscillating circuit that switches current into a chip scale air core transformer. Power transferred to the secondary side is rectified and regulated to either 3.3 V or 5 V. The secondary ( $V_{ISO}$ ) side controller regulates the output by creating a PWM control signal that is sent to the primary ( $V_{DD1}$ ) side by a dedicated *iCoupler* data channel. The PWM modulates the oscillator circuit to control the power being sent to the secondary side. Feedback allows for significantly higher power and efficiency.

The [ADuM5000W](#) provides a regulation control output ( $RC_{OUT}$ ) signal that can be connected to other *isoPower* devices. This feature allows a single regulator to control multiple power modules without contention. When auxiliary power modules are present, the  $V_{ISO}$  pins can be connected together to work as a single supply. Because there is only one feedback control path, the supplies work together seamlessly. The [ADuM5000W](#) can be a source of regulation control, as well as being controlled by another *isoPower* device.

There is an undervoltage lockout (UVLO) with hysteresis in the  $V_{DD1}$  input protection circuit. When the input voltage rises above the UVLO threshold, the dc-to-dc converter becomes active. The input voltage must be decreased below the turn-on threshold by the hysteresis value to disable the converter. This feature has many benefits in the power-up sequence of the converter, such as ensuring that the system supply rises to a minimum level before the [ADuM5000W](#) demands current. It also prevents any voltage drop due to converter current from turning the supply off and possibly oscillating.

### PCB LAYOUT

The [ADuM5000W](#) digital isolator is a 0.5 W *isoPower* integrated dc-to-dc converter that requires no external interface circuitry for the logic interfaces. Power supply bypassing is required at the input and output supply pins (see Figure 14).

The power supply section of the [ADuM5000W](#) uses a 180 MHz oscillator frequency to pass power efficiently through its chip scale transformers. In addition, the normal operation of the data section of the *iCoupler* introduces switching transients on the power supply pins. Bypass capacitors are required for several operating frequencies. Noise suppression requires a low inductance, high frequency capacitor, whereas ripple suppression and proper regulation require a large value capacitor. These capacitors are most conveniently connected between Pin 1 and Pin 2 for  $V_{DD1}$ , and between Pin 15 and Pin 16 for  $V_{ISO}$ .

To suppress noise and reduce ripple, a parallel combination of at least two capacitors is required. The recommended capacitor values are 0.1  $\mu\text{F}$  and 10  $\mu\text{F}$ . Best practice recommends using a very low inductance ceramic capacitor, or its equivalent, for the smaller value. The total lead length between both ends of the capacitor and the input power supply pin should not exceed 10 mm. Consider bypassing between Pin 1 and Pin 8 and between Pin 9 and Pin 16 unless both common ground pins are connected together close to the package.

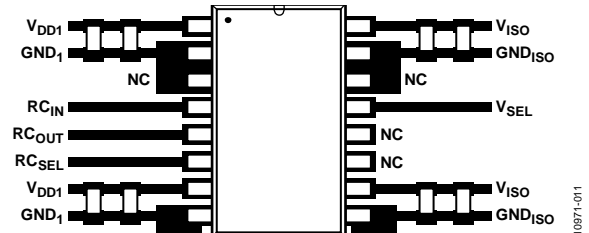

Figure 14. Recommended PCB Layout

In applications involving high common-mode transients, ensure that board coupling across the isolation barrier is minimized. Furthermore, design the board layout such that any coupling that does occur affects all pins equally on a given component side. Failure to ensure this can cause voltage differentials between pins exceeding the absolute maximum ratings for the device as specified in Table 10, thereby leading to latch-up and/or permanent damage.

The [ADuM5000W](#) is a power device that dissipates approximately 1 W of power when fully loaded. Because it is not possible to apply a heat sink to an isolation device, the device primarily depends on heat dissipation into the PCB through the GND pins. If the device is used at high ambient temperatures, provide a thermal path from the GND pins to the PCB ground plane. The board layout in Figure 14 shows enlarged pads for Pin 2 and Pin 8 ( $GND_1$ ) and for Pin 9 and Pin 15 ( $GND_{ISO}$ ). Implement multiple vias from the pad to the ground plane to significantly reduce the temperature inside the chip. The dimensions of the expanded pads are at the discretion of the designer and depend on the available board space.

### START-UP BEHAVIOR

The [ADuM5000W](#) does not contain a soft start circuit. Take the start-up current and voltage behavior into account when designing with this device.

When power is applied to  $V_{DD1}$ , the input switching circuit begins to operate and draw current when the UVLO minimum voltage is reached. The switching circuit drives the maximum available power to the output until it reaches the regulation voltage where PWM control begins. The amount of current and time this takes depends on the load and the  $V_{DD1}$  slew rate.

With a fast  $V_{DD1}$  slew rate (200  $\mu$ s or less), the peak current draws up to 100 mA/V of  $V_{DD1}$ . The input voltage goes high faster than the output can turn on; therefore, the peak current is proportional to the maximum input voltage.

With a slow  $V_{DD1}$  slew rate (in the millisecond range), the input voltage does not change quickly when  $V_{DD1}$  reaches UVLO. The current surge is about 300 mA because  $V_{DD1}$  is nearly constant at the 2.7 V UVLO point. The behavior during start-up is similar to when the device load is a short circuit; these values are consistent with the short-circuit current shown in Figure 7.

When starting the device for  $V_{ISO} = 5$  V operation, do not limit the current available to the  $V_{DD1}$  power pin to less than 300 mA. The ADuM5000W may not be able to drive the output to the regulation point if a current-limiting device clamps the  $V_{DD1}$  voltage during startup. As a result, the ADuM5000W can draw large amounts of current at low voltage for extended periods.

The output voltage of the ADuM5000W device exhibits  $V_{ISO}$  over-shoot during startup. If this could potentially damage components attached to  $V_{ISO}$ , then a voltage-limiting device, such as a Zener diode, can be used to clamp the voltage. Typical behavior is shown in Figure 12 and Figure 13.

## EMI CONSIDERATIONS

It is necessary for the dc-to-dc converter section of the ADuM5000W to operate at 180 MHz to allow efficient power transfer through the small transformers. This creates high frequency currents that can propagate in circuit board ground and power planes, causing edge emissions and dipole radiation between the input and output ground planes. Grounded enclosures are recommended for applications that use these devices. If grounded enclosures are not possible, follow good RF design practices in the layout of the PCB. See the AN-0971 Application Note for board layout recommendations.

## THERMAL ANALYSIS

The ADuM5000W consists of four internal silicon die, attached to a split lead frame with two die attach paddles. For the purposes of thermal analysis, it is treated as a thermal unit with the highest junction temperature reflected in the  $\theta_{JA}$  from Table 5. The value of  $\theta_{JA}$  is based on measurements taken with the part mounted on a JEDEC standard 4-layer board with fine width traces and still air. Under normal operating conditions, the ADuM5000W operates at full load across the full temperature range without derating the output current. However, following the recommendations in the PCB Layout section decreases the thermal resistance to the PCB, allowing increased thermal margin at high ambient temperatures.

## CURRENT LIMIT AND THERMAL OVERLOAD PROTECTION

The ADuM5000W is protected against damage due to excessive power dissipation by thermal overload protection circuits. Thermal overload protection limits the junction temperature to a maximum of 150°C (typical). Under extreme conditions (that is, high ambient temperature and power dissipation), when the junction temperature starts to rise above 150°C, the PWM is turned off, which turns off the output current. When the junction temperature falls below 130°C (typical), the PWM turns on again, restoring the output current to its nominal value.

Consider the case where a hard short from  $V_{ISO}$  to ground occurs. At first, the ADuM5000W reaches its maximum current, which is proportional to the voltage applied at  $V_{DD1}$ . Power dissipates on the primary side of the converter (see Figure 7). If self-heating of the junction becomes great enough to cause its temperature to rise above 150°C, thermal shutdown activates, turning off the PWM and turning off the output current. As the junction temperature cools and falls below 130°C, the PWM turns on and power dissipates again on the primary side of the converter, causing the junction temperature to rise to 150°C again. This thermal oscillation between 130°C and 150°C causes the part to cycle on and off as long as the short remains at the output.

Thermal limit protections are intended to protect the device against accidental overload conditions. For reliable operation, externally limit device power dissipation to prevent junction temperatures from exceeding 130°C.

## POWER CONSIDERATIONS

The ADuM5000W converter primary side is protected from pre-mature operation by undervoltage lockout (UVLO) circuitry. Below the minimum operating voltage, the power converter holds its oscillator inactive.

When the primary side oscillator begins to operate, it transfers power to the secondary power circuits. The secondary  $V_{ISO}$  voltage starts below its UVLO limit making it inactive and unable to generate a regulation control signal. The primary side power oscillator is allowed to free run under this condition, supplying the maximum amount of power to the secondary side.

As the secondary side voltage rises to its regulation setpoint, a large inrush current transient is present at  $V_{DD1}$ . When the regulation point is reached, the regulation control circuit produces the regulation control signal that modulates the oscillator on the primary side. The  $V_{DD1}$  current is then reduced and is proportional to the load current. The inrush current is less than the short-circuit current shown in Figure 7. The duration of the inrush depends on the  $V_{ISO}$  loading conditions and on the current and voltage available at the  $V_{DD1}$  pin.

## INCREASING AVAILABLE POWER

The ADuM5000W device is designed to work in combination with other compatible *isoPower* devices. The RC<sub>OUT</sub>, RC<sub>IN</sub>, and RC<sub>SEL</sub> pins allow the ADuM5000W to provide its PWM signal to another device through the RC<sub>OUT</sub> pin acting as a master. It can also receive a PWM signal from another device through its RC<sub>IN</sub> pin and act as a slave to that control signal. The RC<sub>SEL</sub> pin chooses whether the part acts as a master or slave device.

When the ADuM5000W is acting as a slave, its power is regulated by the master device, allowing multiple *isoPower* parts to be combined in parallel while sharing the load equally. When the ADuM5000W is configured as a master or stand-alone unit, it generates its own PWM feedback signal to regulate itself and slave devices.

The ADuM5000W can function as a master, slave, or stand-alone device. All devices in the ADuM5xxx and ADuM6xxx family can function as standalone devices. Some of these devices also function as master devices or slave devices, but not both (see Table 14).

Table 15 shows how *isoPower* devices can provide many combinations of data channel count and multiples of the single unit power.

Table 14. Allowed Combinations of *isoPower* Parts

Part No.	Function		
	Master	Slave	Standalone
ADuM6000	Yes	Yes	Yes
ADuM620x	No	Yes	Yes
ADuM640x	No	No	Yes
ADuM5000	Yes	Yes	Yes
ADuM520x	No	Yes	Yes
ADuM5400	No	No	Yes
ADuM5401 to ADuM5404	Yes	No	Yes

Another feature allowed by the RC<sub>SEL</sub> and RC<sub>IN</sub> control architecture is the ability to completely shut down the oscillator in the dc-to-dc converter. This places the part in a low power standby mode and reduces the current draw to a fraction of a milliamp.

When the ADuM5000W is placed in slave mode by driving RC<sub>SEL</sub> low, the oscillator is controlled by RC<sub>IN</sub>. If RC<sub>IN</sub> is held low, the oscillator is shut down and the part is in low power standby mode. With no oscillator driving power to the secondary side, V<sub>ISO</sub> turns off. This mode is useful for applications where an isolated subsystem may be shut down to conserve power. To reactivate the power module, drive RC<sub>SEL</sub> high; the power supply resumes operation.

Table 15. Configurations for Power and Data Channels

Power Units	Number of Data Channels		
	0 Channels	2 Channels	4 Channels
<b>1-Unit Power</b>	ADuM6000 or ADuM5000W (standalone)	ADuM620x or ADuM520x (standalone)	ADuM5401, ADuM5402, ADuM5403, ADuM5404, or ADuM640x (standalone)
<b>2-Unit Power</b>	ADuM6000 or ADuM5000W (master) ADuM6000 or ADuM5000W (slave)	ADuM6000 or ADuM5000W (master) ADuM620x or ADuM520x (slave)	ADuM5401, ADuM5402, ADuM5403, ADuM5404 (master) ADuM6000 or ADuM5000W (slave)
<b>3-Unit Power</b>	ADuM6000 or ADuM5000W (master) ADuM6000 or ADuM5000W (slave) ADuM6000 or ADuM5000W (slave)	ADuM6000 or ADuM5000W (master) ADuM6000 or ADuM5000W (slave) ADuM620x or ADuM520x (slave)	ADuM6000 or ADuM5000W (master) ADuM620x or ADuM520x (slave) ADuM620x or ADuM520x (slave)

## INSULATION LIFETIME

All insulation structures eventually break down when subjected to voltage stress over a sufficiently long period. The rate of insulation degradation is dependent on the characteristics of the voltage waveform applied across the insulation. In addition to the testing performed by the regulatory agencies, Analog Devices carries out an extensive set of evaluations to determine the lifetime of the insulation structure within the [ADuM5000W](#).

Analog Devices performs accelerated life testing using voltage levels higher than the rated continuous working voltage. Acceleration factors for several operating conditions are determined. These factors allow calculation of the time to failure at the actual working voltage. The values shown in Table 11 summarize the peak voltage for 50 years of service life for a bipolar ac operating condition, and the maximum CSA/VDE approved working voltages. In many cases, the approved working voltage is higher than 50-year service life voltage. Operation at these high working voltages can lead to shortened insulation life in some cases.

The insulation lifetime of the [ADuM5000W](#) depends on the voltage waveform imposed across the isolation barrier. The *iCoupler* insulation structure degrades at different rates depending on whether the waveform is bipolar ac, unipolar ac, or dc. Figure 15, Figure 16, and Figure 17 illustrate these different isolation voltage waveforms.

Bipolar ac voltage is the most stringent environment. The goal of a 50-year operating lifetime under the ac bipolar condition determines the maximum working voltage that Analog Devices recommends.

In the case of unipolar ac or dc voltage, the stress on the insulation is significantly lower. This allows operation at higher working voltages while still achieving a 50-year service life. The working voltages listed in Table 11 can be applied while maintaining the 50-year minimum lifetime, provided the voltage conforms to either the unipolar ac or dc voltage cases. Treat any cross insulation voltage waveform that does not conform to Figure 16 or Figure 17 as a bipolar ac waveform and limit its peak voltage to the 50-year lifetime voltage value listed in Table 11. The voltage presented in Figure 16 is shown as sinusoidal for illustration purposes only. It is meant to represent any voltage waveform varying between 0 V and some limiting value. The limiting value can be positive or negative, but the voltage cannot cross 0 V.

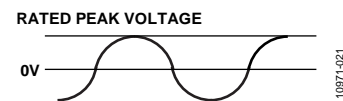

Figure 15. Bipolar AC Waveform

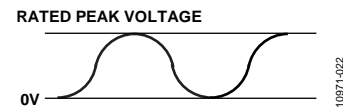

Figure 16. Unipolar AC Waveform

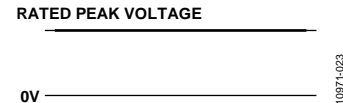
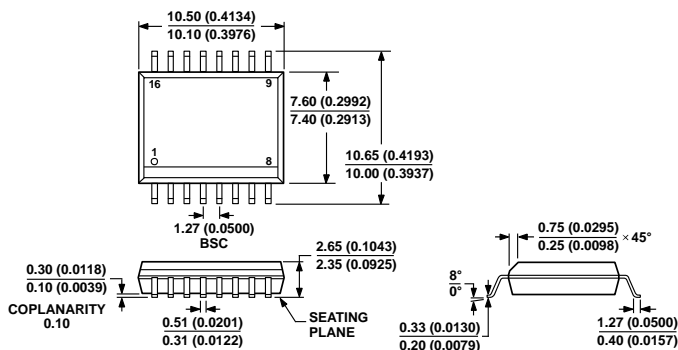

Figure 17. DC Waveform

# OUTLINE DIMENSIONS



COMPLIANT TO JEDEC STANDARDS MS-013-AA  
 CONTROLLING DIMENSIONS ARE IN MILLIMETERS; INCH DIMENSIONS  
 (IN PARENTHESES) ARE ROUNDED-OFF MILLIMETER EQUIVALENTS FOR  
 REFERENCE ONLY AND ARE NOT APPROPRIATE FOR USE IN DESIGN.

03-27-2007-8

Figure 18. 16-Lead Standard Small Outline Package [SOIC\_W]  
 Wide Body  
 (RW-16)

Dimensions shown in millimeters and (inches)

## ORDERING GUIDE

Model <sup>1, 2</sup>	Temperature Range	Package Description	Package Option
ADuM5000WARWZ	-40°C to +105°C	16-Lead SOIC_W	RW-16
ADUM5000WARWZ-RL	-40°C to +105°C	16-Lead SOIC_W, 13" Tape and Reel	RW-16

<sup>1</sup> Z = RoHS Compliant Part.

<sup>2</sup> W = Qualified for Automotive Applications.

## AUTOMOTIVE PRODUCTS

The **ADuM5000W** model is available with controlled manufacturing to support the quality and reliability requirements of automotive applications. Note that these automotive model may have specifications that differ from the commercial model; therefore, designers should review the Specifications section of this data sheet carefully. Only the automotive grade products shown are available for use in automotive applications. Contact your local Analog Devices account representative for specific product ordering information and to obtain the specific Automotive Reliability reports for these models.

## Looking for pricing, stock, or lifecycle information?

Click below to explore more details on WIN SOURCE:

- ⊖ [View ADUM5000WARWZ-RL on WIN SOURCE](#)
- ⊖ [Analog Devices Inc. Information](#)

## Optimize Your Supply Chain with WIN SOURCE Solutions

- ✓ Global Sourcing Solution
- ✓ Obsolete Management
- ✓ Cost Control Management
- ✓ Shortage Management
- ✓ Alternative Solution
- ✓ Excess Inventory Management