



**THE DATASHEET OF
MA4P7433-287T**



Features

- Industry Standard Surface Mount Packages
- Lead-Free (RoHS* Compliant)
- Available with 260°C Reflow Compatibility
- Low Loss, High Isolation Switching Diodes
- Low Distortion Attenuator Diodes
- Single and Dual Diode Configurations
- Tape and Reel Packaging

Description and Applications

MACOM offers silicon PIN diodes in five standard, low cost, surface mount plastic packages for use as switches and attenuators. These diodes are offered with 100% matte Sn plating. These PIN diodes feature a variety of I-region lengths resulting in lower resistance, and lower capacitance devices for various microwave control circuit applications.

The MA4P7436, and MADP-007436 series offer the lowest series resistance for best performance as low loss series switches and high isolation shunt switches.

The MA4P7433, and MADP-007433 series have the lowest capacitance and offers the highest isolation in series and series-shunt switches through 3 GHz.

The MA4P7447, MADP-007155 series, MA4P7455, MADP-007455 series and the MADP-007448 series are general purpose PIN diodes useful as either switches or attenuators.

The MA4P7437, MADP-007437 series and MA4P7438, MADP-007438 series device have thicker intrinsic regions to provide lower distortion in attenuator circuits.

The MADP-007167 series devices have the thickest I-Region, offering the lowest distortion and highest IP3 for current controlled attenuator circuits. These devices are ideal for AGC functions for infrastructure and CATV applications.

These parts are available as single diodes, series tees (ST), series tee reverse (STR), common cathode pairs (CK), and common anode pairs (CA). MACOM's PIN diodes are available in the SOT-23 (case style 287), the SOT-323/SC-70(3L) (case style 1146), the SOD-323 (case style 1141), and the SC-79 (case style 1279) packages. These packages are supplied on tape and reel for automatic pick and place assembly. The tape and reel suffix designation is a "T" at the end of the part number.

Package Outlines

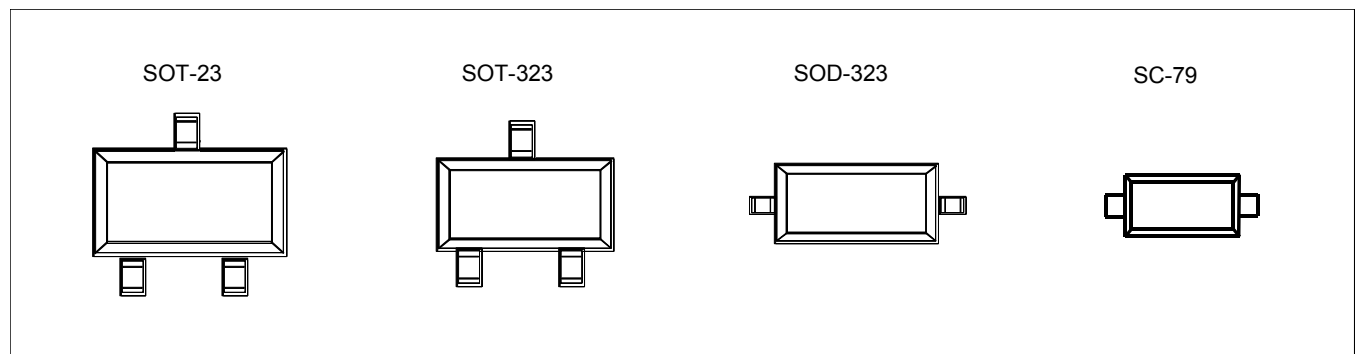

* Restrictions on Hazardous Substances, European Union Directive 2011/65/EU.

Surface Mount Plastic PIN Diodes

Rev. V25

Electrical Specifications @ +25°C

Part #	Reverse Voltage ¹ (V)	Total Capacitance ² Maximum (pF)	RS @ 10 mA ³ Maximum (Ohms)	Nominal Characteristics	
				Carrier Lifetime ⁴ (µs)	I-Region Thickness (mils)
MA4P7436 MADP-007436 Series	75	1.00 @ 20 V	0.5	0.2	0.4
MA4P7433 MADP-007433 Series	75	0.35 @ 20 V	1.5	0.2	0.4
MA4P7447 MADP-007155 Series	100	1.20 @ 20 V	0.6	1.0	0.8
MADP-007448 Series	100	0.25 @ 50 V	2.0	0.4	0.6
MA4P7455 MADP-007455 Series	100	0.35 @ 50 V	3.0	1.0	2.0
MA4P7437 MADP-007437 Series	200	0.35 @ 50 V	6.0	2.0	4.0
MA4P7438 MADP-007438 Series	200	0.35 @ 50 V	10.0	3.0	5.0
MADP-007167	200	0.30 @ 50 V	16.0	3.0	7.0

1. The reverse current will not exceed 10 µA at the reverse voltage rating.
2. Total capacitance is measured at 1 MHz at the indicated voltage.
3. Series resistance is measured at the specified current and a frequency of 100 MHz.
4. Nominal minority carrier lifetime is measured at $I_F = 10$ mA, $I_R = 6$ mA, 90% recovery.

Absolute Maximum Ratings @ +25°C⁵ (Unless Otherwise Noted)

Parameter	Rating
Operating Temperature	-65°C to +150°C
Storage Temperature	-65°C to +125°C
Junction Temperature	+175°C
RF CW Incident Power: MA4P7447, MADP-007155 Series (θ die = 15°C/W), RF & DC Incident De-rating Coefficient = -21.3 mW/°C MA4P7436, MADP-007436 Series (θ die = 25°C/W), RF & DC Incident De-rating Coefficient = -16.8 mW/°C MA4P7438, MADP-007438 Series (θ die = 30°C/W), RF & DC Incident De-rating Coefficient = -13.3 mW/°C MA4P7455, MADP-007455 Series (θ die = 35°C/W), RF & DC Incident De-rating Coefficient = -13.3 mW/°C MA4P7437, MADP-007437 Series (θ die = 45°C/W), RF & DC Incident De-rating Coefficient = -13.3 mW/°C MADP-007167 Series (θ die = 55°C/W), RF & DC Incident De-rating Coefficient = -13.3 mW/°C MA4P7433, MADP-007433 Series (θ die = 80°C/W), RF & DC Incident De-rating Coefficient = -10.7 mW/°C MADP-007448 Series (θ die = 80°C/W), RF & DC Incident De-rating Coefficient = -10.7 mW/°C	+32 dBm +31 dBm +30 dBm +30 dBm +30 dBm +30 dBm +30 dBm +29 dBm +32 dBm
Total (RF + DC) Power Dissipation: (SOT-23): RF & DC Dissipated De-rating Coefficient = -33.3 mW/°C (SOT-323, SOD-323, SC-79): RF & DC Dissipated De-rating Coefficient = -26.7 mW/°C	250 mW 200 mW
Reverse Voltage	Voltage Rating
Forward Current	150 mA DC

5. Operation of these devices above any one of these parameters may cause permanent damage.

2

MACOM Technology Solutions Inc. (MACOM) and its affiliates reserve the right to make changes to the product(s) or information contained herein without notice. Visit www.macom.com for additional data sheets and product information.

For further information and support please visit:
<https://www.macom.com/support>

DC-0007054

Packaging and Configurations

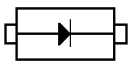
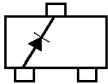
			
Single		Single	
SC-79 Part #	SOD-323 Part #	SOT-23 Part #	SC70 (3L) Part #
$L_s = 0.6 \text{ nH}, C_p = 0.10 \text{ pF}$	$L_s = 1.3 \text{ nH}, C_p = 0.11 \text{ pF}$	$L_s = 1.4 \text{ nH}, C_p = 0.12 \text{ pF}$	$L_s = 1.3 \text{ nH}, C_p = 0.12 \text{ pF}$
MADP-007436-12790T	MA4P7436-1141T	MA4P7436-287T	MA4P7436-1146T
MADP-007433-12790T	MA4P7433-1141T	MA4P7433-287T	—
—	MA4P7447-1141T	MA4P7447-287T	—
MADP-007448-12790T	MADP-007448-11410T	MADP-007448-0287AT	—
MADP-007455-12790T	MA4P7455-1141T	MA4P7455-287T	—
—	MA4P7437-1141T	MA4P7437-287T	—
—	MA4P7438-1141T	MA4P7438-287T	—
—	MADP-007167-11410T	MADP-007167-0287AT	—

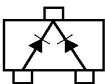
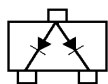
			
Common Cathode		Common Anode	
SOT-23 Part #	SC70 (3L) Part #	SOT-23 Part #	SC70 (3L) Part #
$L_s = 1.4 \text{ nH}, C_p = 0.12 \text{ pF}$	$L_s = 1.3 \text{ nH}, C_p = 0.12 \text{ pF}$	$L_s = 1.4 \text{ nH}, C_p = 0.12 \text{ pF}$	$L_s = 1.3 \text{ nH}, C_p = 0.12 \text{ pF}$
MA4P7436CK-287T	MA4P7436CK-1146T	MA4P7436CA-287T	MA4P7436CA-1146T
MA4P7433CK-287T	MA4P7433CK-1146T	MA4P7433CA-287T	MA4P7433CA-1146T
MA4P7447CK-287T	—	MA4P7447CA-287T	—
MADP-007448-0287FT	—	MADP-007448-0287GT	MADP-007448-1146GT
MA4P7455CK-287T	MA4P7455CK-1146T	MA4P7455CA-287T	MA4P7455CA-1146T
MADP-007437-0287FT	—	MA4P7437CA-287T	—
MADP-007438-0287FT	—	MA4P7438CA-287T	—
MADP-007167-0287FT	—	MADP-007167-0287GT	—

Packaging and Configurations

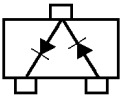
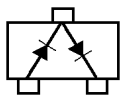
			
Series Tee		Series Tee Reverse	
SOT-23 Part #	SC70 (3L) Part #	SOT-23 Part #	SC70 (3L) Part #
$L_S = 1.4 \text{ nH}, C_P = 0.12 \text{ pF}$	$L_S = 1.3 \text{ nH}, C_P = 0.12 \text{ pF}$	$L_S = 1.4 \text{ nH}, C_P = 0.12 \text{ pF}$	$L_S = 1.3 \text{ nH}, C_P = 0.12 \text{ pF}$
MA4P7436ST-287T	MA4P7436ST-1146T	MADP-007436-0287DT	MADP-007436-1146DT
MA4P7433ST-287T	MA4P7433ST-1146T	MADP-007433-0287DT	MADP-007433-1146DT
MA4P7447ST-287T	—	MADP-007155-0287DT	—
MADP-007448-0287BT	MADP-007448-1146BT	MADP-007448-0287DT	MADP-007448-1146DT
MA4P7455ST-287T	MA4P7455ST-1146T	MADP-007455-0287DT	MADP-007455-1146DT
MADP-007437-0287BT	—	MADP-007437-0287DT	—
MADP-007438-0287BT	—	MADP-007438-0287DT	—
MADP-007167-0287BT	—	MADP-007167-0287DT	—

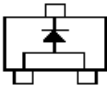

Low Inductance
SOT-23 Part #
$L_S = 0.4 \text{ nH}, C_P = 0.12 \text{ pF}$
MADP-007167-0287HT
MADP-007433-0287HT

Typical Forward Resistance vs. DC Bias Current Curves @ 100 MHz

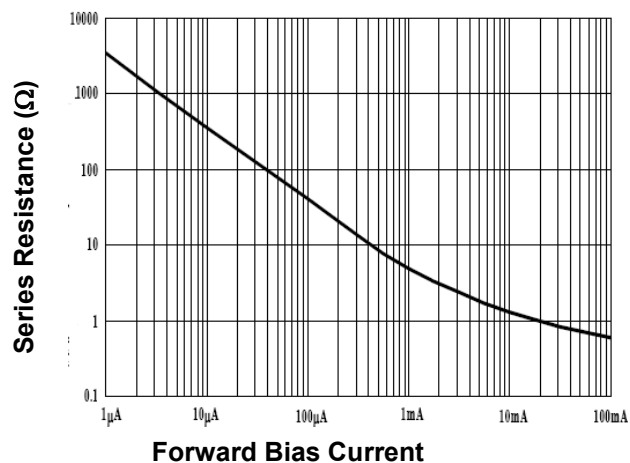
*Resistance vs. Forward Current
(MA4P7455 /MADP-007155 Series)*

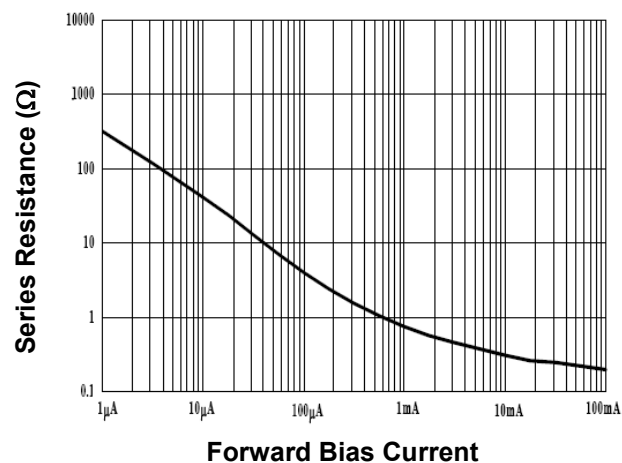

*Resistance vs. Forward Current
(MA4P7436 /MADP-007436 Series)*



*Resistance vs. Forward Current
(MA4P7437 /MADP-007437 Series)*

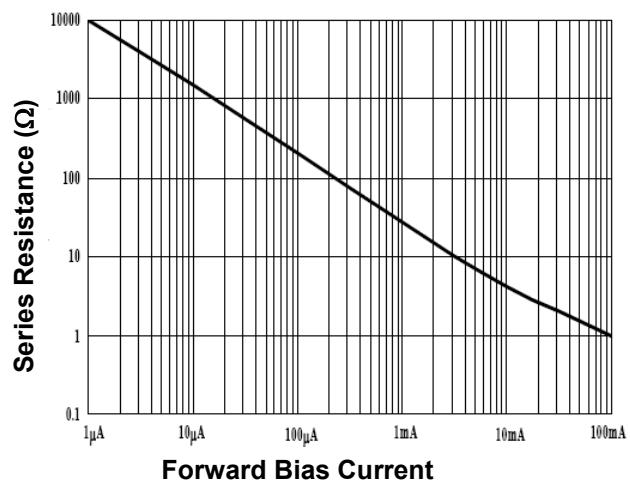

*Resistance vs. Forward Current
(MA4P7438 /MADP-007438 Series)*

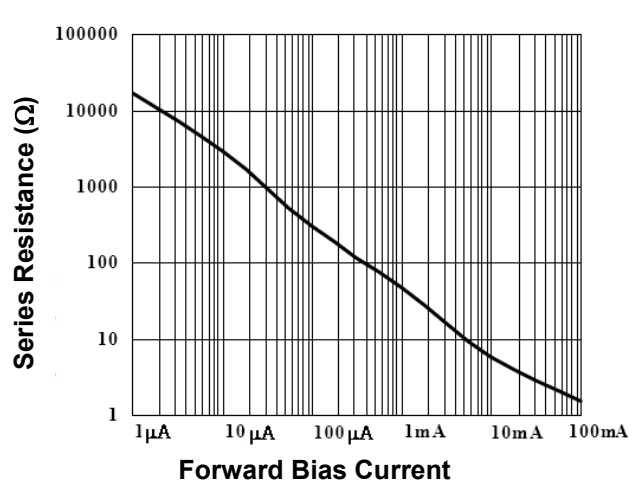

Typical Forward Resistance vs. DC Bias Current Curves @ 100 MHz

Resistance vs. Forward Current
(MA4P7447 / MADP-007155 Series)

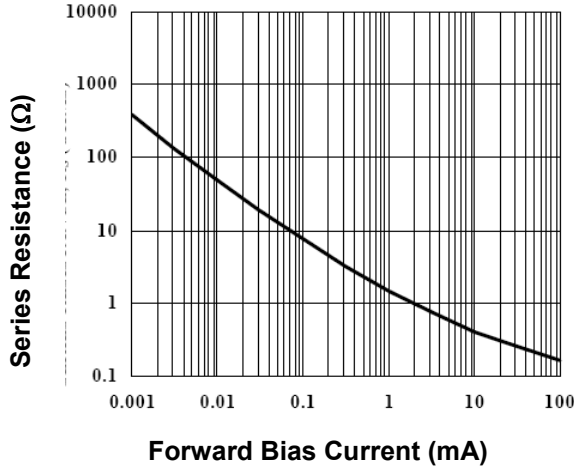

Resistance vs. Forward Current
(MA4P7433/ MADP-007433 Series)

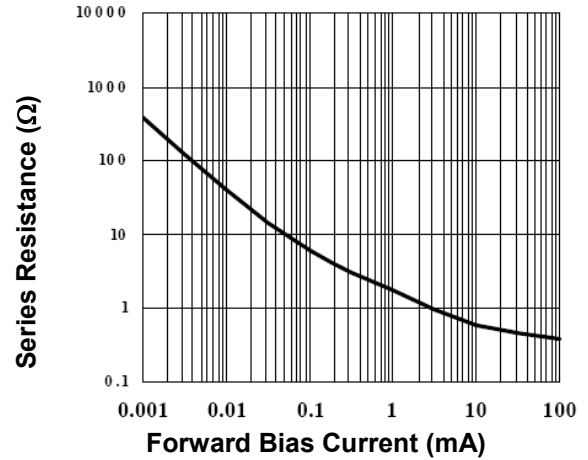

Resistance vs. Forward Current
(MADP-007167 Series)

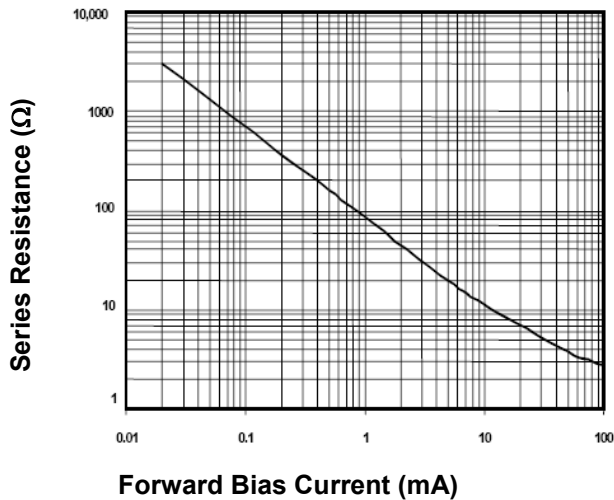

Resistance vs. Forward Current
(MADP-007448 Series)

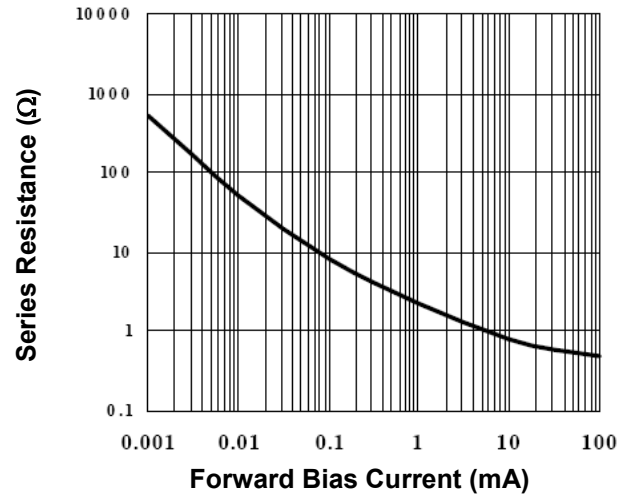

Case Styles

SOT-23 (Case Style 287)

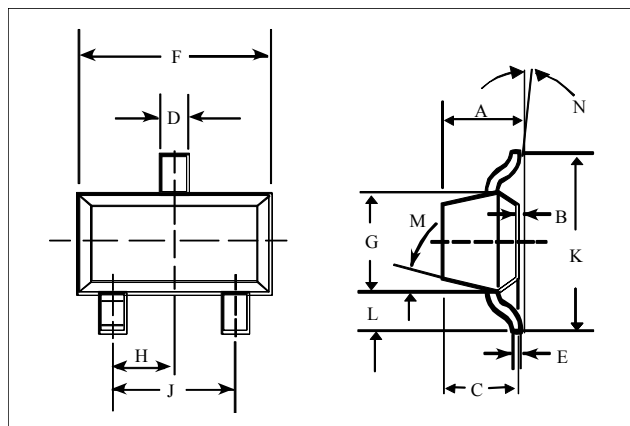

DIM.	INCHES		MILLIMETERS	
	MIN.	MAX.	MIN.	MAX.
A	—	0.048	—	1.22
B	—	0.008	—	0.20
C	—	0.040	—	1.00
D	0.013	0.020	0.35	0.50
E	0.003	0.006	0.08	0.15
F	0.110	0.119	2.80	3.00
G	0.047	0.056	1.20	1.40
H	0.037 typical		0.95 typical	
J	0.075 typical		1.90 typical	
K	—	0.103	—	2.60
L	—	0.024	—	0.60
DIM.	GRADIENT			
M	10° max. ⁶			
N	2° . . . 30°			

6. Applicable on all sides

SC-70, 3 Lead (Case Style 1146)

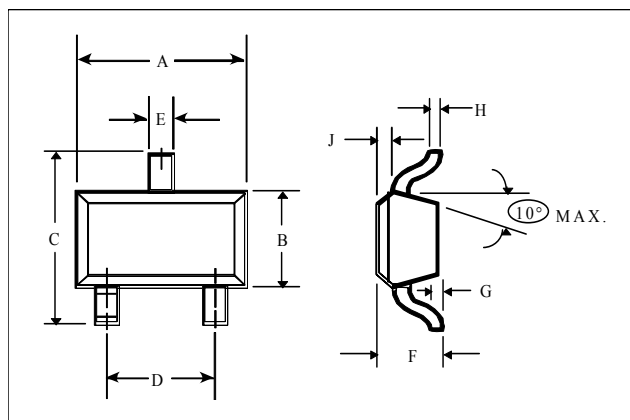

DIM.	INCHES		MILLIMETERS	
	MIN.	MAX.	MIN.	MAX.
A	0.071	0.087	1.80	2.21
B	0.045	0.053	1.14	1.35
C	0.071	0.094	1.80	2.39
D	0.047	0.057	1.19	1.45
E	0.010	0.016	0.25	0.41
F	0.031	0.039	0.79	1.00
G	0.000	0.004	0.00	0.10
H	0.004	0.007	0.10	0.18
J	0.004	0.010	0.10	0.25

Case Styles (Cont'd)

SC-79 (Case Style 1279)

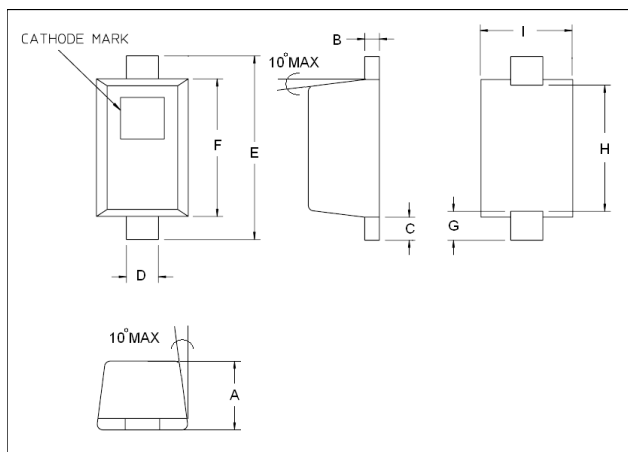

DIM.	INCHES		MILLIMETERS	
	MIN.	MAX.	MIN.	MAX.
A	0.0197	0.0276	0.50	0.70
B	0.003	0.008	0.07	0.20
C	0.006	0.010	0.15	0.25
D	0.010	0.014	0.25	0.35
E	0.059	0.067	1.50	1.70
F	0.043	0.051	1.09	1.30
G	0.0098 nominal		0.250 nominal	
H	0.0433 nominal		1.10 nominal	
I	0.027	0.035	0.68	0.89

SOD-323 (Case Style 1141)

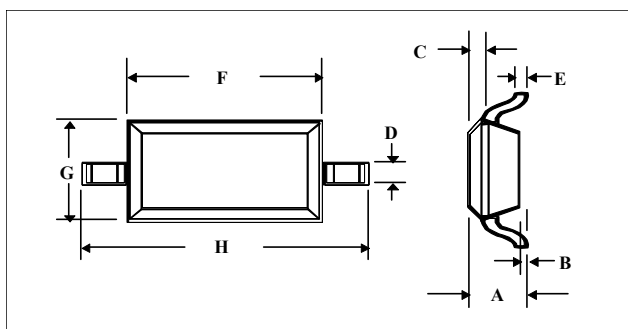

DIM.	INCHES		MILLIMETERS	
	MIN.	MAX.	MIN.	MAX.
A	—	0.043	—	1.1
B	—	0.004	—	0.1
C	—	0.008	—	0.2
D	0.010	0.016	0.25	0.41
E	0.003	0.006	0.07	0.15
F	0.063	0.075	1.6	1.9
G	0.045	0.057	1.14	1.45
H	0.091	0.106	2.3	2.7

Mounting Information

The illustration indicates the recommended mounting pad configuration for the SOT-23, SOT-323, SOD-323, and SC-79 packages. Solder paste containing flux should be screened onto the pads to a thickness of 0.005- 0.007 inches. The plastic package is placed in position, firmly adhering to the solder paste.

Permanent attachment is performed by a reflow soldering procedure during which the tab temperature does not exceed +275°C and the body temperature does not exceed +250°C, for standard models and +260°C for the RoHS compliant devices.

Please refer to Application Note M538 for surface mounting instructions.

SOT-323

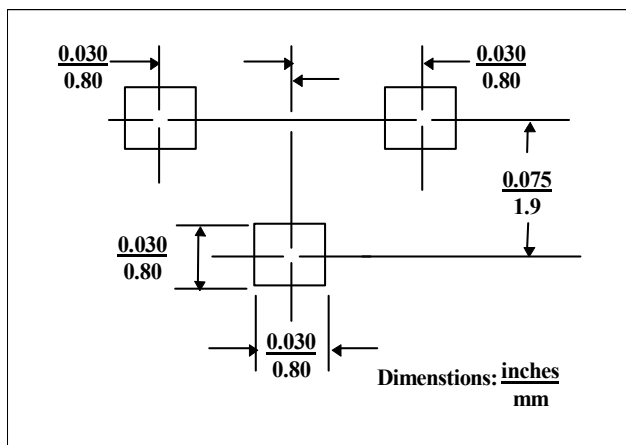

SOT-23

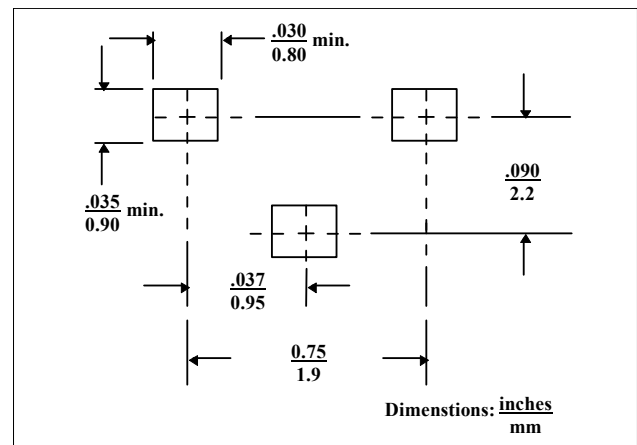

SC-79

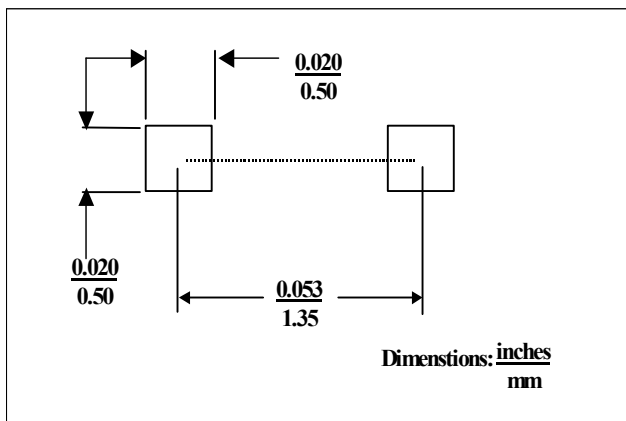

SOD-323

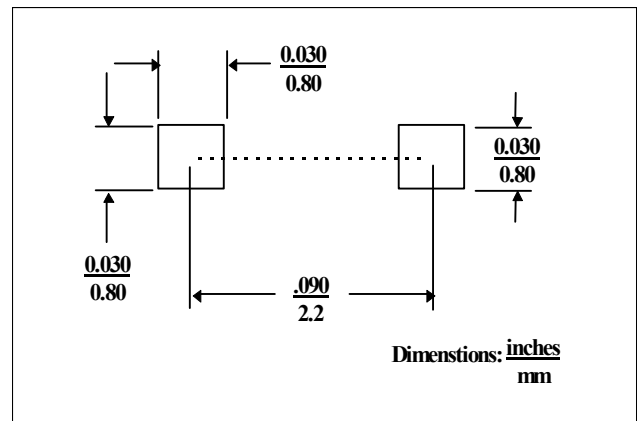

MACOM Technology Solutions Inc. All rights reserved.

Information in this document is provided in connection with MACOM Technology Solutions Inc ("MACOM") products. These materials are provided by MACOM as a service to its customers and may be used for informational purposes only. Except as provided in MACOM's Terms and Conditions of Sale for such products or in any separate agreement related to this document, MACOM assumes no liability whatsoever. MACOM assumes no responsibility for errors or omissions in these materials. MACOM may make changes to specifications and product descriptions at any time, without notice. MACOM makes no commitment to update the information and shall have no responsibility whatsoever for conflicts or incompatibilities arising from future changes to its specifications and product descriptions. No license, express or implied, by estoppel or otherwise, to any intellectual property rights is granted by this document.

THESE MATERIALS ARE PROVIDED "AS IS" WITHOUT WARRANTY OF ANY KIND, EITHER EXPRESS OR IMPLIED, RELATING TO SALE AND/OR USE OF MACOM PRODUCTS INCLUDING LIABILITY OR WARRANTIES RELATING TO FITNESS FOR A PARTICULAR PURPOSE, CONSEQUENTIAL OR INCIDENTAL DAMAGES, MERCHANTABILITY, OR INFRINGEMENT OF ANY PATENT, COPYRIGHT OR OTHER INTELLECTUAL PROPERTY RIGHT. MACOM FURTHER DOES NOT WARRANT THE ACCURACY OR COMPLETENESS OF THE INFORMATION, TEXT, GRAPHICS OR OTHER ITEMS CONTAINED WITHIN THESE MATERIALS. MACOM SHALL NOT BE LIABLE FOR ANY SPECIAL, INDIRECT, INCIDENTAL, OR CONSEQUENTIAL DAMAGES, INCLUDING WITHOUT LIMITATION, LOST REVENUES OR LOST PROFITS, WHICH MAY RESULT FROM THE USE OF THESE MATERIALS.

MACOM products are not intended for use in medical, lifesaving or life sustaining applications. MACOM customers using or selling MACOM products for use in such applications do so at their own risk and agree to fully indemnify MACOM for any damages resulting from such improper use or sale.

Looking for pricing, stock, or lifecycle information?

Click below to explore more details on WIN SOURCE:

- ⊖ [View MA4P7433-287T on WIN SOURCE](#)
- ⊖ [M/A-Com Technology Solutions Information](#)

Optimize Your Supply Chain with WIN SOURCE Solutions

- ✓ Global Sourcing Solution
- ✓ Obsolete Management
- ✓ Cost Control Management
- ✓ Shortage Management
- ✓ Alternative Solution
- ✓ Excess Inventory Management