



**THE DATASHEET OF
AS7805ADTR-E1**



Description

The AS78XXA series are three terminal positive voltage regulators designed for a wide variety of applications including local, on-card regulation.

The AS78XXA are complete with internal current limiting, thermal shutdown protection, and safe-area compensation which make them virtually immune from output overload. If adequate heat sinking is provided, these regulators can deliver output currents up to 1A.

The AS78XXA are available in TO-252-2 (3), TO-252-2 (4), TO-252-2 (5), TO-220-3, TO-220-3 (2) and TO-220F-3 packages.

Applications

- High Efficiency Linear Regulator
- Post Regulation for Switching Supply
- Microprocessor Power Supply
- Mother Board

Features

- Output Current up to 1A
- Fixed Output Voltages of 5V, 6V, 8V, 9V, 12V, 15V and 18V
- Output Voltage Accuracy of $\pm 4\%$ over the Full Temperature Range
- Internal Short Circuit Current Limiting
- Internal Thermal Overload Protection
- Output Transistor Safe-area Protection
- Low Load Regulation
- Stable Performance in High Temperature
- TO-220-3, TO-220-3 (2) and TO-220F-3
 - **Lead-Free Finish; RoHS Compliant (Notes 1 & 2)**
- Lead-Free Packages: TO-252-2 (3), TO-252-2 (4), TO-252-2 (5)
 - **Totally Lead-Free; RoHS Compliant (Notes 4 & 2)**
- Available in "Green" Packages: TO-220-3, TO-220-3 (2) and TO-220F-3
 - **Lead-Free Finish; RoHS Compliant (Notes 1 & 2)**
 - **Halogen and Antimony Free. "Green" Device (Note 3)**
- Lead-Free Packages, Available in "Green" Molding Compound: TO-252-2 (3), TO-252-2 (4), TO-252-2 (5)
 - **Totally Lead-Free & Fully RoHS Compliant (Notes 4 & 2)**
 - **Halogen and Antimony Free. "Green" Device (Note 3)**

- Notes:
1. EU Directive 2002/95/EC (RoHS), 2011/65/EU (RoHS 2) & 2015/863/EU (RoHS 3) compliant. All applicable RoHS exemptions applied.
 2. See <https://www.diodes.com/quality/lead-free/> for more information about Diodes Incorporated's definitions of Halogen- and Antimony-free, "Green" and Lead-free.
 3. Halogen- and Antimony-free "Green" products are defined as those which contain <900ppm bromine, <900ppm chlorine (<1500ppm total Br + Cl) and <1000ppm antimony compounds.
 4. No purposely added lead. Fully EU Directive 2002/95/EC (RoHS), 2011/65/EU (RoHS 2) & 2015/863/EU (RoHS 3) compliant.

Pin Assignments

(Front View)



TO-220-3 (Option 1)

(Front View)



TO-220-3 (Option 2)

Pin Assignments (Cont.)

(Front View)



TO-220-3 (Option 3)

(Front View)

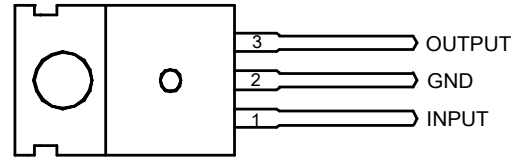

TO-220-3 (2)

(Front View)

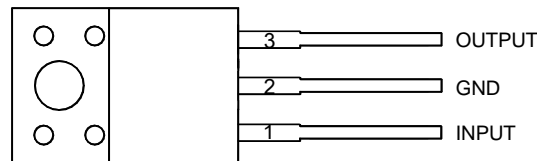

TO-220F-3

(Top View)

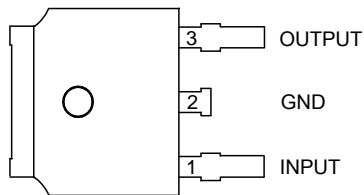

TO-252-2 (3) (Option 1)

(Top View)



TO-252-2 (3) (Option 2)

(Top View)

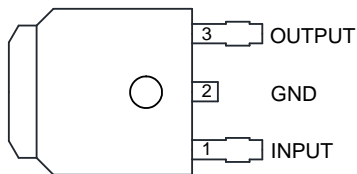

TO-252-2 (4)

(Top View)

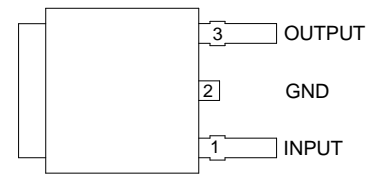

TO-252-2 (5)

Typical Applications Circuit



Pin Descriptions

Pin Number	Pin Name	Function
1	INPUT	Voltage Input
2	GND	Ground
3	OUTPUT	Voltage Output

Functional Block Diagram



Absolute Maximum Ratings (Note 5)

Symbol	Parameter	Rating		Unit
V_{IN}	Input Voltage	36		V
T_{LEAD}	Lead Temperature (Soldering, 10sec)	+260		°C
P_D	Power Dissipation	Internally Limited		W
T_J	Operating Junction Temperature	+150		°C
T_{STG}	Storage Temperature Range	-65 to +150		°C
θ_{JA}	Thermal Resistance	TO-220-3/TO-220-3 (2)	60	°C/W
		TO-252-2 (3)/TO-252-2 (4)/TO-252-2 (5)	100	
		TO-220F-3	60	
ESD	ESD (Human Body Model)	6000		V
ESD	ESD (Machine Model)	500		V

Note 5: Stresses greater than those listed under “Absolute Maximum Ratings” may cause permanent damage to the device. These are stress ratings only, and functional operation of the device at these or any other conditions beyond those indicated under “Recommended Operating Conditions” is not implied. Exposure to “Absolute Maximum Ratings” for extended periods may affect device reliability.

Recommended Operating Conditions

Symbol	Parameter	Min	Max	Unit	
V_{IN}	Input Voltage	AS7805A	—	25	V
		AS7806A	—	26	
		AS7808A	—	28	
		AS7809A	—	29	
		AS7812A	—	32	
		AS7815A	—	32	
		AS7818A	—	32	
T_J	Operating Junction Temperature Range	-40	+125	°C	

Electrical Characteristics

AS7805A (@ $V_{IN} = 10V$, $I_{OUT} = 1A$, $T_J = -40$ to $+125^\circ C$, unless otherwise specified.)

Symbol	Parameter	Conditions	Min	Typ	Max	Unit
V_{OUT}	Output Voltage	$T_J = +25^\circ C$	4.9	5	5.1	V
		$I_{OUT} = 5mA$ to $1A$, $V_{IN} = 7.5V$ to $20V$, $P_D \leq 15W$	4.8	—	5.2	
V_{RLINE}	Line Regulation	$V_{IN} = 7.5V$ to $20V$, $I_{OUT} = 500mA$, $T_J = +25^\circ C$	—	25	50	mV
V_{RLOAD}	Load Regulation	$V_{IN} = 10V$, $I_{OUT} = 5mA$ to $1A$, $T_J = +25^\circ C$	—	20	50	mV
I_Q	Quiescent Current	$V_{IN} = 10V$, $I_{OUT} = 0$	—	3.2	6	mA
ΔI_Q	Quiescent Current Change	$V_{IN} = 8V$ to $25V$, $I_{OUT} = 500mA$, $T_J = +25^\circ C$	—	0.3	0.8	mA
		$I_{OUT} = 5mA$ to $1A$, $T_J = +25^\circ C$	—	0.08	0.5	
PSRR	Ripple Rejection	$V_{IN} = 8V$ to $18V$, $f = 120Hz$, $I_{OUT} = 500mA$	—	70	—	dB
V_{DROP}	Dropout Voltage	$\Delta V_{OUT} = 1\%$, $I_{OUT} = 1A$, $T_J = +25^\circ C$	—	2	—	V
N_O	Output Noise Voltage	$f = 10Hz$ to $100kHz$, $T_A = +25^\circ C$	—	10	—	$\mu V/V_O$
R_O	Output Resistance	$f = 1kHz$	—	10	—	m Ω
I_{SC}	Short Circuit Current	$V_{IN} = 35V$, $T_A = +25^\circ C$	—	0.05	—	A
I_{PK}	Peak Output Current	$V_{IN} = 10V$, $T_J = +25^\circ C$	—	2.2	—	A
$\Delta V_{OUT}/\Delta T$	Output Voltage Temperature Coefficient	—	—	0.4	—	mV/ $^\circ C$
$(\Delta V_{OUT}/V_{OUT})/\Delta T$		—	—	80	—	ppm/ $^\circ C$
θ_{JC}	Thermal Resistance	TO-220-3/TO-220-3 (2)	—	9	—	$^\circ C/W$
		TO-252-2 (3)/ TO-252-2 (4)/ TO-252-2 (5)	—	16	—	
		TO-220F-3	—	9	—	
			—			

Electrical Characteristics (Cont.)

AS7806A (@ $V_{IN} = 11V$, $I_{OUT} = 1A$, $T_J = -40$ to $+125^\circ C$, unless otherwise specified.)

Symbol	Parameter	Conditions	Min	Typ	Max	Unit
V_{OUT}	Output Voltage	$T_J = +25^\circ C$	5.88	6	6.12	V
		$I_{OUT} = 5mA$ to $1A$, $V_{IN} = 8.6V$ to $21V$, $P_D \leq 15W$	5.76	—	6.24	
V_{RLINE}	Line Regulation	$V_{IN} = 8.6V$ to $21V$, $I_{OUT} = 500mA$, $T_J = +25^\circ C$	—	25	60	mV
V_{RLOAD}	Load Regulation	$V_{IN} = 11V$, $I_{OUT} = 5mA$ to $1A$, $T_J = +25^\circ C$	—	20	60	mV
I_Q	Quiescent Current	$V_{IN} = 11V$, $I_{OUT} = 0$	—	3.2	6	mA
ΔI_Q	Quiescent Current Change	$V_{IN} = 8.6V$ to $21V$, $I_{OUT} = 500mA$, $T_J = +25^\circ C$	—	0.3	0.8	mA
		$I_{OUT} = 5mA$ to $1A$, $T_J = +25^\circ C$	—	0.08	0.5	
PSRR	Ripple Rejection	$V_{IN} = 9.5V$ to $19.5V$, $f = 120Hz$, $I_{OUT} = 500mA$	—	65	—	dB
V_{DROP}	Dropout Voltage	$\Delta V_{OUT} = 1\%$, $I_{OUT} = 1A$, $T_J = +25^\circ C$	—	2	—	V
N_O	Output Noise Voltage	$f = 10Hz$ to $100kHz$, $T_A = 25^\circ C$	—	10	—	$\mu V/V_O$
R_O	Output Resistance	$f = 1kHz$	—	10	—	m Ω
I_{SC}	Short Circuit Current	$V_{IN} = 35V$, $T_A = +25^\circ C$	—	0.2	—	A
I_{PK}	Peak Output Current	$V_{IN} = 11V$, $T_J = +25^\circ C$	—	2.2	—	A
$\Delta V_{OUT}/\Delta T$	Output Voltage Temperature Coefficient	—	—	0.5	—	mV/ $^\circ C$
$(\Delta V_{OUT}/V_{OUT})/\Delta T$		—	—	80	—	ppm/ $^\circ C$
θ_{JC}	Thermal Resistance	TO-220-3/TO-220-3 (2)	—	9	—	$^\circ C/W$
		TO-252-2 (3)/ TO-252-2 (4)/ TO-252-2 (5)	—	16	—	
		TO-220F-3	—	9	—	
			—	9	—	

Electrical Characteristics (Cont.)

AS7808A (@ $V_{IN} = 14V$, $I_{OUT} = 1A$, $T_J = -40$ to $+125^{\circ}C$, unless otherwise specified.)

Symbol	Parameter	Conditions	Min	Typ	Max	Unit
V_{OUT}	Output Voltage	$T_J = +25^{\circ}C$	7.84	8	8.16	V
		$I_{OUT} = 5mA$ to $1A$, $V_{IN} = 10.6V$ to $23V$, $P_D \leq 15W$	7.7	—	8.3	
V_{RLINE}	Line Regulation	$V_{IN} = 10.6V$ to $23V$, $I_{OUT} = 500mA$, $T_J = +25^{\circ}C$	—	25	75	mV
V_{RLOAD}	Load Regulation	$V_{IN} = 14V$, $I_{OUT} = 5mA$ to $1A$, $T_J = +25^{\circ}C$	—	25	75	mV
I_Q	Quiescent Current	$V_{IN} = 14V$, $I_{OUT} = 0$	—	3.2	6	mA
ΔI_Q	Quiescent Current Change	$V_{IN} = 10.6V$ to $23V$, $I_{OUT} = 500mA$, $T_J = +25^{\circ}C$	—	0.3	0.8	mA
		$I_{OUT} = 5mA$ to $1A$, $T_J = +25^{\circ}C$	—	0.08	0.5	
PSRR	Ripple Rejection	$V_{IN} = 11.5V$ to $21.5V$, $f = 120Hz$, $I_{OUT} = 500mA$	—	62	—	dB
V_{DROP}	Dropout Voltage	$\Delta V_{OUT} = 1\%$, $I_{OUT} = 1A$, $T_J = +25^{\circ}C$	—	2	—	V
N_O	Output Noise Voltage	$f = 10Hz$ to $100kHz$, $T_A = +25^{\circ}C$	—	10	—	$\mu V/V_O$
R_O	Output Resistance	$f = 1kHz$	—	10	—	m Ω
I_{SC}	Short Circuit Current	$V_{IN} = 35V$, $T_A = +25^{\circ}C$	—	0.2	—	A
I_{PK}	Peak Output Current	$V_{IN} = 14V$, $T_J = +25^{\circ}C$	—	2.2	—	A
$\Delta V_{OUT}/\Delta T$	Output Voltage Temperature Coefficient	—	—	0.64	—	mV/ $^{\circ}C$
$(\Delta V_{OUT}/V_{OUT})/\Delta T$		—	—	80	—	ppm/ $^{\circ}C$
θ_{JC}	Thermal Resistance	TO-220-3/TO-220-3 (2)	—	9	—	$^{\circ}C/W$
		TO-252-2 (3)/ TO-252-2 (4)/ TO-252-2 (5)	—	16	—	
		TO-220F-3	—	9	—	

Electrical Characteristics (Cont.)

AS7809A (@ $V_{IN} = 15V$, $I_{OUT} = 1A$, $T_J = -40$ to $+125^{\circ}C$, unless otherwise specified.)

Symbol	Parameter	Conditions	Min	Typ	Max	Unit
V_{OUT}	Output Voltage	$T_J = +25^{\circ}C$	8.82	9	9.18	V
		$I_{OUT} = 5mA$ to $1A$, $V_{IN} = 11.5V$ to $23V$, $P_D \leq 15W$	8.65	—	9.35	
V_{RLINE}	Line Regulation	$V_{IN} = 11.5V$ to $23V$, $I_{OUT} = 500mA$, $T_J = +25^{\circ}C$	—	25	90	mV
V_{RLOAD}	Load Regulation	$V_{IN} = 14V$, $I_{OUT} = 5mA$ to $1A$, $T_J = +25^{\circ}C$	—	25	100	mV
I_Q	Quiescent Current	$V_{IN} = 15V$, $I_{OUT} = 0$	—	3.2	6	mA
ΔI_Q	Quiescent Current Change	$V_{IN} = 11.5V$ to $23V$, $I_{OUT} = 500mA$, $T_J = +25^{\circ}C$	—	0.3	0.8	mA
		$I_{OUT} = 5mA$ to $1A$, $T_J = +25^{\circ}C$	—	0.08	0.5	
PSRR	Ripple Rejection	$V_{IN} = 11.5V$ to $21.5V$, $f = 120Hz$, $I_{OUT} = 500mA$	—	61	—	dB
V_{DROP}	Dropout Voltage	$\Delta V_{OUT} = 1\%$, $I_{OUT} = 1A$, $T_J = +25^{\circ}C$	—	2	—	V
N_O	Output Noise Voltage	$f = 10Hz$ to $100kHz$, $T_A = +25^{\circ}C$	—	10	—	$\mu V/V_O$
R_O	Output Resistance	$f = 1kHz$	—	10	—	m Ω
I_{SC}	Short Circuit Current	$V_{IN} = 35V$, $T_A = +25^{\circ}C$	—	0.2	—	A
I_{PK}	Peak Output Current	$V_{IN} = 15V$, $T_J = +25^{\circ}C$	—	2.2	—	A
$\Delta V_{OUT}/\Delta T$	Output Voltage Temperature Coefficient	—	—	0.72	—	mV/ $^{\circ}C$
$(\Delta V_{OUT}/V_{OUT})/\Delta T$		—	—	80	—	ppm/ $^{\circ}C$
θ_{JC}	Thermal Resistance	TO-220-3/TO-220-3 (2)	—	9	—	$^{\circ}C/W$
		TO-252-2 (3)/ TO-252-2 (4)/ TO-252-2 (5)	—	16	—	
		TO-220F-3	—	9	—	
			—	9	—	

Electrical Characteristics (Cont.)

AS7812A (@ $V_{IN} = 19V$, $I_{OUT} = 1A$, $T_J = -40$ to $+125^\circ C$, unless otherwise specified.)

Symbol	Parameter	Conditions	Min	Typ	Max	Unit
V_{OUT}	Output Voltage	$T_J = +25^\circ C$	11.75	12	12.25	V
		$I_{OUT} = 5mA$ to $1A$, $V_{IN} = 14.8V$ to $27V$, $P_D \leq 15W$	11.5	—	12.5	
V_{RLINE}	Line Regulation	$V_{IN} = 14.8V$ to $27V$, $I_{OUT} = 500mA$, $T_J = +25^\circ C$	—	25	120	mV
V_{RLOAD}	Load Regulation	$V_{IN} = 19V$, $I_{OUT} = 5mA$ to $1A$, $T_J = +25^\circ C$	—	40	120	mV
I_Q	Quiescent Current	$V_{IN} = 19V$, $I_{OUT} = 0$	—	3.4	6	mA
ΔI_Q	Quiescent Current Change	$V_{IN} = 14.8V$ to $30V$, $I_{OUT} = 500mA$, $T_J = +25^\circ C$	—	0.3	0.8	mA
		$I_{OUT} = 5mA$ to $1A$, $T_J = +25^\circ C$	—	0.08	0.5	
PSRR	Ripple Rejection	$V_{IN} = 15V$ to $25V$, $f = 120Hz$, $I_{OUT} = 500mA$	—	60	—	dB
V_{DROP}	Dropout Voltage	$\Delta V_{OUT} = 1\%$, $I_{OUT} = 1A$, $T_J = +25^\circ C$	—	2	—	V
N_O	Output Noise Voltage	$f = 10Hz$ to $100kHz$, $T_A = +25^\circ C$	—	10	—	$\mu V/V_O$
R_O	Output Resistance	$f = 1kHz$	—	11	—	m Ω
I_{SC}	Short Circuit Current	$V_{IN} = 35V$, $T_A = +25^\circ C$	—	0.2	—	A
I_{PK}	Peak Output Current	$V_{IN} = 18V$, $T_J = +25^\circ C$	—	2.2	—	A
$\Delta V_{OUT}/\Delta T$	Output Voltage Temperature Coefficient	—	—	0.96	—	mV/ $^\circ C$
$(\Delta V_{OUT}/V_{OUT})/\Delta T$		—	—	80	—	ppm/ $^\circ C$
θ_{JC}	Thermal Resistance	TO-220-3/TO-220-3 (2)	—	9	—	$^\circ C/W$
		TO-252-2 (3)/ TO-252-2 (4)/ TO-252-2 (5)	—	16	—	
		TO-220F-3	—	9	—	
			—			

Electrical Characteristics (Cont.)

AS7815A (@ $V_{IN} = 23V$, $I_{OUT} = 1A$, $T_J = -40$ to $+125^{\circ}C$, unless otherwise specified.)

Symbol	Parameter	Conditions	Min	Typ	Max	Unit
V_{OUT}	Output Voltage	$T_J = +25^{\circ}C$	14.7	15	15.3	V
		$I_{OUT} = 5mA$ to $1A$, $V_{IN} = 17.9V$ to $30V$, $P_D \leq 15W$	14.4	—	15.6	
V_{RLINE}	Line Regulation	$V_{IN} = 17.9V$ to $30V$, $I_{OUT} = 500mA$, $T_J = +25^{\circ}C$	—	35	150	mV
V_{RLOAD}	Load Regulation	$V_{IN} = 23V$, $I_{OUT} = 5mA$ to $1A$, $T_J = +25^{\circ}C$	—	70	150	mV
I_Q	Quiescent Current	$V_{IN} = 23V$, $I_{OUT} = 0$	—	3.4	6	mA
ΔI_Q	Quiescent Current Change	$V_{IN} = 17.9V$ to $30V$, $I_{OUT} = 500mA$, $T_J = +25^{\circ}C$	—	0.3	0.8	mA
		$I_{OUT} = 5mA$ to $1A$, $T_J = +25^{\circ}C$	—	0.08	0.5	
PSRR	Ripple Rejection	$V_{IN} = 18.5V$ to $28.5V$, $f = 120Hz$, $I_{OUT} = 500mA$	—	58	—	dB
V_{DROP}	Dropout Voltage	$\Delta V_{OUT} = 1\%$, $I_{OUT} = 1A$, $T_J = +25^{\circ}C$	—	2	—	V
N_O	Output Noise Voltage	$f = 10Hz$ to $100kHz$, $T_A = +25^{\circ}C$	—	10	—	$\mu V/V_O$
R_O	Output Resistance	$f = 1kHz$	—	11	—	m Ω
I_{SC}	Short Circuit Current	$V_{IN} = 35V$, $T_A = +25^{\circ}C$	—	0.2	—	A
I_{PK}	Peak Output Current	$V_{IN} = 21V$, $T_J = +25^{\circ}C$	—	2.2	—	A
$\Delta V_{OUT}/\Delta T$	Output Voltage Temperature Coefficient	—	—	1.2	—	mV/ $^{\circ}C$
$(\Delta V_{OUT}/V_{OUT})/\Delta T$		—	—	80	—	ppm/ $^{\circ}C$
θ_{JC}	Thermal Resistance	TO-220-3/TO-220-3 (2)	—	9	—	$^{\circ}C/W$
		TO-252-2 (3)/ TO-252-2 (4)/ TO-252-2 (5)	—	16	—	
		TO-220F-3	—	9	—	
			—	9	—	

Electrical Characteristics (Cont.)

AS7818A (@ $V_{IN} = 27V$, $I_{OUT} = 1A$, $T_J = -40$ to $+125^{\circ}C$, unless otherwise specified.)

Symbol	Parameter	Conditions	Min	Typ	Max	Unit
V_{OUT}	Output Voltage	$T_J = +25^{\circ}C$	17.64	18	18.36	V
		$I_{OUT} = 5mA$ to $1A$, $V_{IN} = 21V$ to $33V$, $P_D \leq 15W$	17.3	—	18.7	
V_{RLINE}	Line Regulation	$V_{IN} = 21V$ to $33V$, $I_{OUT} = 500mA$, $T_J = +25^{\circ}C$	—	45	180	mV
V_{RLOAD}	Load Regulation	$V_{IN} = 27V$, $I_{OUT} = 5mA$ to $1A$, $T_J = +25^{\circ}C$	—	85	180	mV
I_Q	Quiescent Current	$V_{IN} = 27V$, $I_{OUT} = 0$	—	3.6	6	mA
ΔI_Q	Quiescent Current Change	$V_{IN} = 21V$ to $33V$, $I_{OUT} = 500mA$, $T_J = +25^{\circ}C$	—	0.3	0.8	mA
		$I_{OUT} = 5mA$ to $1A$, $T_J = +25^{\circ}C$	—	0.08	0.5	
PSRR	Ripple Rejection	$V_{IN} = 22V$ to $32V$, $f = 120Hz$, $I_{OUT} = 500mA$	—	57	—	dB
V_{DROP}	Dropout Voltage	$\Delta V_{OUT} = 1\%$, $I_{OUT} = 1A$, $T_J = +25^{\circ}C$	—	2	—	V
N_O	Output Noise Voltage	$f = 10Hz$ to $100kHz$, $T_A = +25^{\circ}C$	—	10	—	$\mu V/V_O$
R_O	Output Resistance	$f = 1kHz$	—	11	—	m Ω
I_{SC}	Short Circuit Current	$V_{IN} = 35V$, $T_A = +25^{\circ}C$	—	0.2	—	A
I_{PK}	Peak Output Current	$V_{IN} = 24V$, $T_J = +25^{\circ}C$	—	2.2	—	A
$\Delta V_{OUT}/\Delta T$	Output Voltage Temperature Coefficient	—	—	1.44	—	mV/ $^{\circ}C$
$(\Delta V_{OUT}/V_{OUT})/\Delta T$		—	—	80	—	ppm/ $^{\circ}C$
θ_{JC}	Thermal Resistance	TO-220-3/TO-220-3 (2)	—	9	—	$^{\circ}C/W$
		TO-252-2 (3)/ TO-252-2 (4)/ TO-252-2 (5)	—	16	—	
		TO-220F-3	—	9	—	
			—			

Performance Characteristics

Peak Output Current vs. Input/Output Differential Voltage

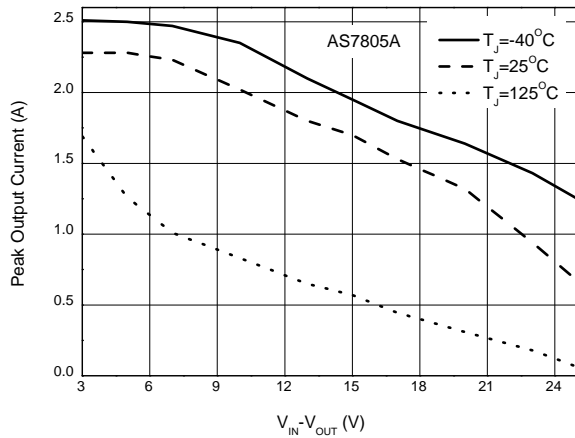

Output Voltage vs. Junction Temperature

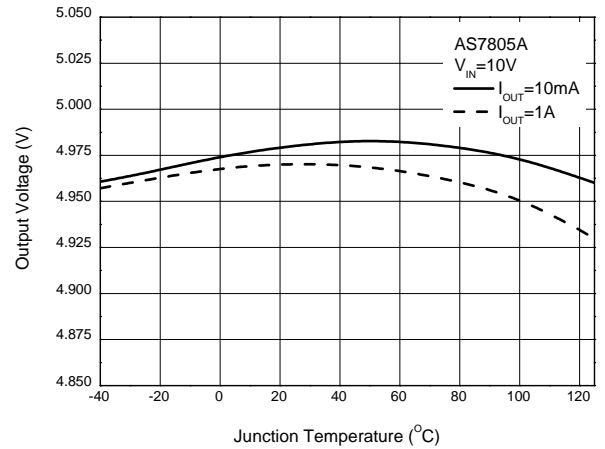

Output Voltage vs. Output Current

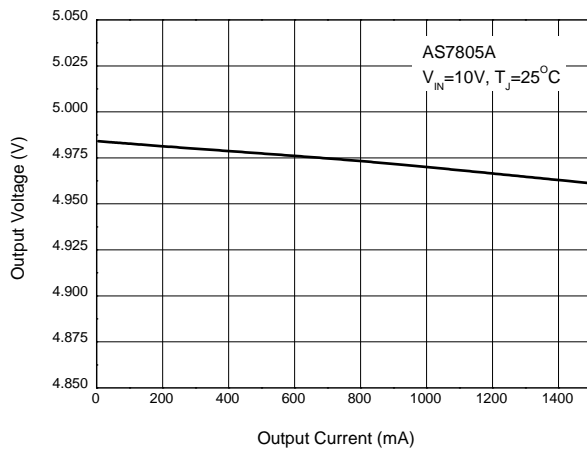

Output Voltage vs. Input Voltage

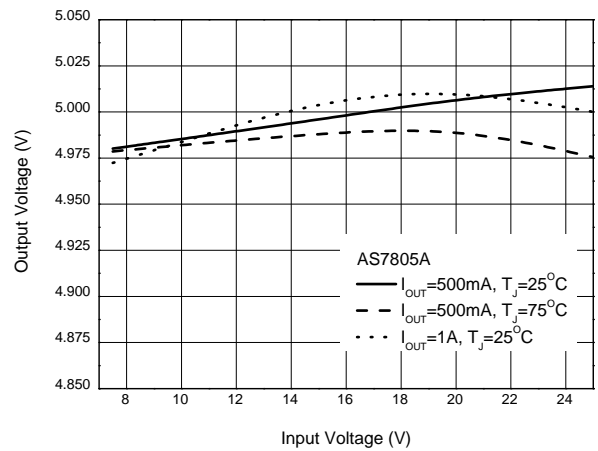

Quiescent Current vs. Junction Temperature

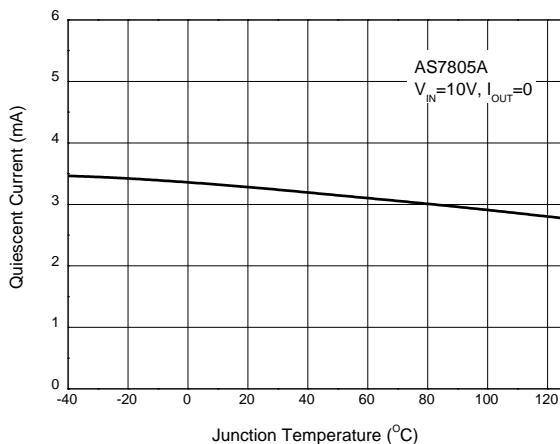

Ripple Rejection vs. Frequency

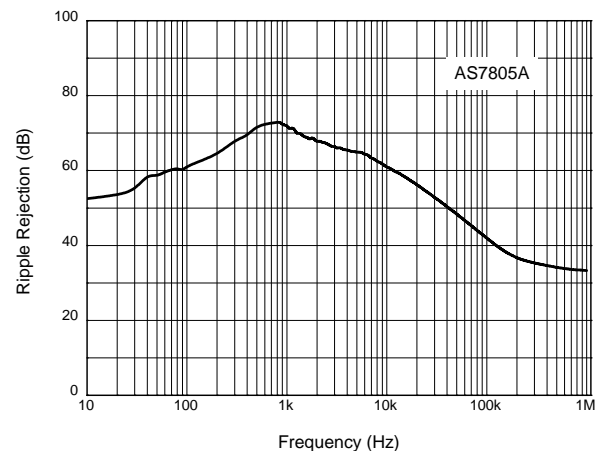

Performance Characteristics (Cont.)

Dropout Voltage vs. Junction Temperature

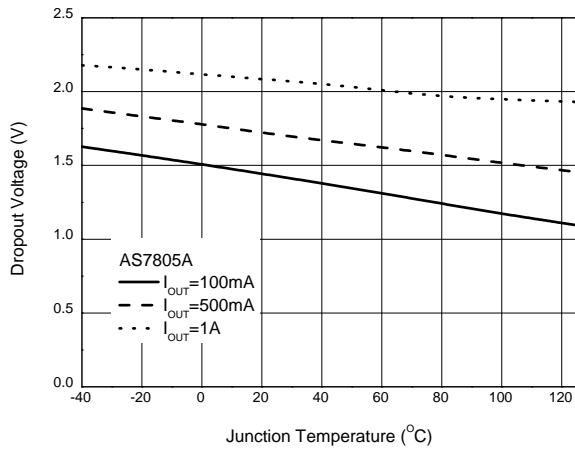

Power Dissipation vs. Junction Temperature

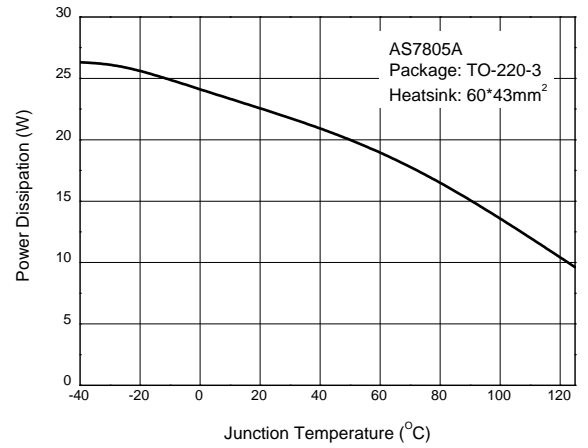

Line Transient
 (Conditions: $I_{OUT} = 500\text{mA}$, $C_{OUT} = 0.1\mu\text{F}$)

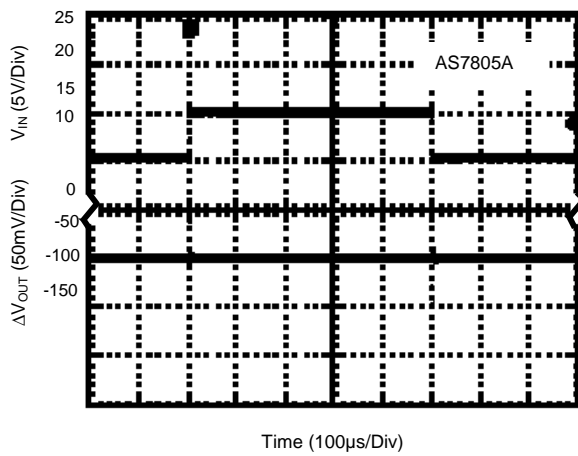

Load Transient
 (Conditions: $V_{IN} = 10\text{V}$, $C_{IN} = 0.33\mu\text{F}$, $C_{OUT} = 0.1\mu\text{F}$)

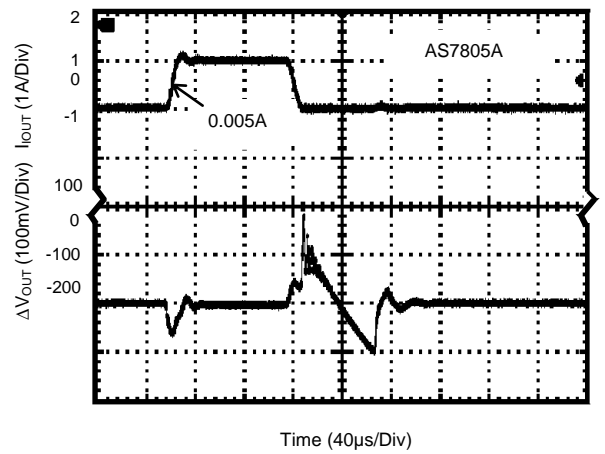

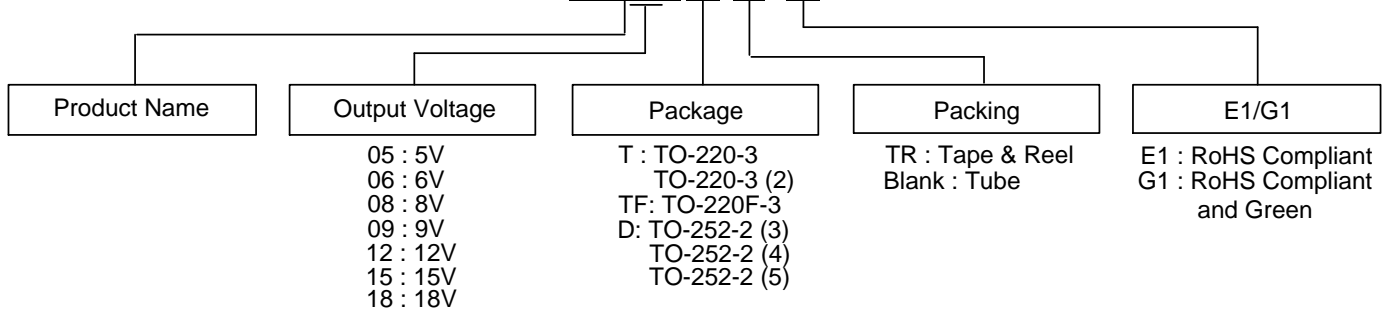
Ordering Information
AS78XXA XX XX - XX

Part Number	Package (Note 7)	Output Voltage (V)	RoHS Compliant Lead Free/ Green	Marking ID	Packing	Quantity	Status (Note 6)	Alternative
AS7805ADTR-E1	TO-252-2 (3)/(4)/(5)	5	Lead Free	AS7805AD-E1	Tape & Reel	2500	NRND	AS7805ADTR-G1
AS7805ADTR-G1		5	Green	AS7805AD-G1	Tape & Reel	2500	In Production	—
AS7805AT-E1	TO-220-3/ (2)	5	Lead Free	AS7805AT-E1	Tube	1000	In Production	—
AS7805AT-G1		5	Green	AS7805AT-G1	Tube	1000	In Production	—
AS7805ATF-E1	TO-220F-3	5	Lead Free	AS7805ATF-E1	Tube	1000	In Production	—
AS7805ATF-G1		5	Green	AS7805ATF-G1	Tube	1000	End of Life	AS7805ATF-E1
AS7806ADTR-E1	TO-252-2 (3)/(4)/(5)	6	Lead Free	AS7806AD-E1	Tape & Reel	2500	NRND	AS7806ADTR-G1
AS7806ADTR-G1		6	Green	AS7806AD-G1	Tape & Reel	2500	In Production	—
AS7806AT-E1	TO-220-3/ (2)	6	Lead Free	AS7806AT-E1	Tube	1000	In Production	—
AS7806AT-G1		6	Green	AS7806AT-G1	Tube	1000	End of Life	AS7806AT-E1
AS7806ATF-E1	TO-220F-3	6	Lead Free	AS7806ATF-E1	Tube	1000	End of Life	None
AS7806ATF-G1		6	Green	AS7806ATF-G1	Tube	1000	End of Life	None
AS7808ADTR-E1	TO-252-2 (3)/(4)/(5)	8	Lead Free	AS7808AD-E1	Tape & Reel	2500	End of Life	None
AS7808ADTR-G1		8	Green	AS7808AD-G1	Tape & Reel	2500	In Production	—
AS7808AT-E1	TO-220-3/ (2)	8	Lead Free	AS7808AT-E1	Tube	1000	In Production	—
AS7808AT-G1		8	Green	AS7808AT-G1	Tube	1000	End of Life	AS7808AT-E1
AS7808ATF-E1	TO-220F-3	8	Lead Free	AS7808ATF-E1	Tube	1000	In Production	—
AS7808ATF-G1		8	Green	AS7808ATF-G1	Tube	1000	End of Life	None
AS7809ADTR-E1	TO-252-2 (3)/(4)/(5)	9	Lead Free	AS7809AD-E1	Tape & Reel	2500	NRND	AS78L05ZTR-G1
AS7809ADTR-G1		9	Green	AS7809AD-G1	Tape & Reel	2500	In Production	—
AS7809AT-E1	TO-220-3/ (2)	9	Lead Free	AS7809AT-E1	Tube	1000	In Production	—
AS7809AT-G1		9	Green	AS7809AT-G1	Tube	1000	End of Life	AS7809AT-E1
AS7809ATF-E1	TO-220F-3	9	Lead Free	AS7809ATF-E1	Tube	1000	In Production	—
AS7809ATF-G1		9	Green	AS7809ATF-G1	Tube	1000	End of Life	AS7809ATF-E1

Ordering Information (Cont.)

Part Number	Package (Note 7)	Output Voltage (V)	RoHS Compliant Lead Free/Green	Marking ID	Packing	Quantity	Status (Note 6)	Alternative
AS7812ADTR-E1	TO-252-2 (3)/(4)/(5)	12	Lead Free	AS7812AD-E1	Tape & Reel	2500	NRND	AS7812ADTR-G1
AS7812ADTR-G1		12	Green	AS7812AD-G1	Tape & Reel	2500	In Production	—
AS7812AT-E1	TO-220-3/ (2)	12	Lead Free	AS7812AT-E1	Tube	1000	In Production	—
AS7812AT-G1		12	Green	AS7812AT-G1	Tube	1000	End of Life	AS7812AT-E1
AS7812ATF-E1	TO-220F-3	12	Lead Free	AS7812ATF-E1	Tube	1000	End of Life	None
AS7812ATF-G1		12	Green	AS7812ATF-G1	Tube	1000	End of Life	None
AS7815ADTR-E1	TO-252-2 (3)/(4)/(5)	15	Lead Free	AS7815AD-E1	Tape & Reel	2500	End of Life	AS7815ADTR-G1
AS7815ADTR-G1		15	Green	AS7815AD-G1	Tape & Reel	2500	In Production	—
AS7815AT-E1	TO-220-3/ (2)	15	Lead Free	AS7815AT-E1	Tube	1000	In Production	—
AS7815AT-G1		15	Green	AS7815AT-G1	Tube	1000	In Production	—
AS7815ATF-E1	TO-220F-3	15	Lead Free	AS7815ATF-E1	Tube	1000	In Production	—
AS7815ATF-G1		15	Green	AS7815ATF-G1	Tube	1000	End of Life	AS7815ATF-E1
AS7818ADTR-E1	TO-252-2 (3)/(4)/(5)	18	Lead Free	AS7818AD-E1	Tape & Reel	2500	NRND	AS7818ADTR-G1
AS7818ADTR-G1		18	Green	AS7818AD-G1	Tape & Reel	2500	In Production	—
AS7818AT-E1	TO-220-3/ (2)	18	Lead Free	AS7818AT-E1	Tube	1000	End of Life	None
AS7818AT-G1		18	Green	AS7818AT-G1	Tube	1000	End of Life	None
AS7818ATF-E1	TO-220F-3	18	Lead Free	AS7818ATF-E1	Tube	1000	In Production	—
AS7818ATF-G1		18	Green	AS7818ATF-G1	Tube	1000	End of Life	AS7818ATF-E1



Notes: 6. NRND: Not Recommended for New Design.
 7. For packaging details, go to our website at: <https://www.diodes.com/design/support/packaging/diodes-packaging/>.

Marking Information

(1) TO-220-3/TO-220-3 (2)

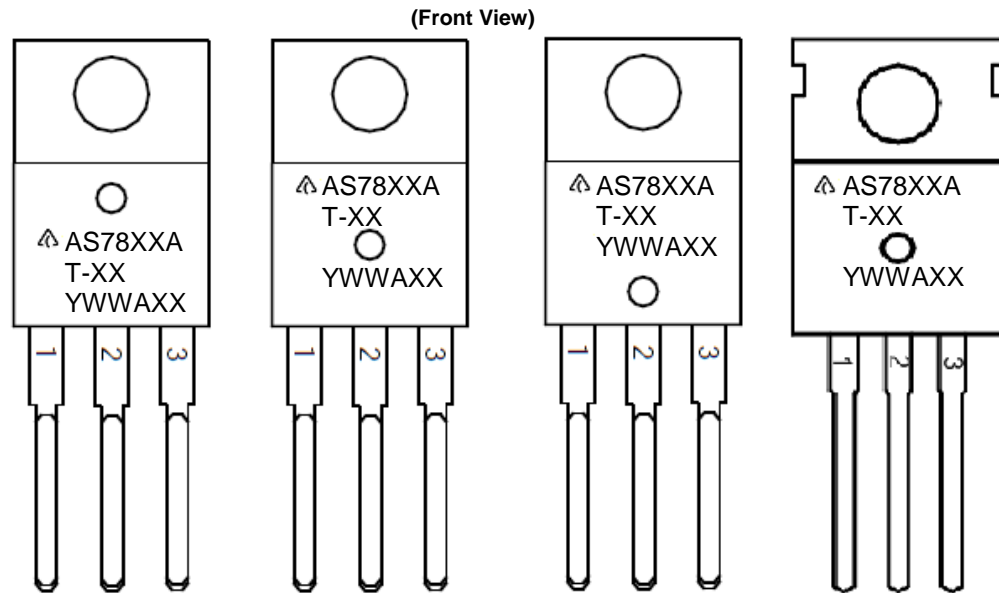

First and Second Lines: Logo and Marking ID
(See Ordering Information)
Third Line: Date Code
Y: Year
WW: Work Week of Molding
A: Assembly House Code
XX: Internal Code

(2) TO-220F-3

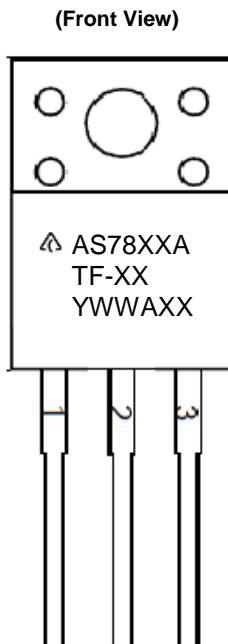

First and Second Lines: Logo and Marking ID
(See Ordering Information)
Third Line: Date Code
Y: Year
WW: Work Week of Molding
A: Assembly House Code
XX: Internal Code

Marking Information (Cont.)

(3) TO-252-2 (3)/(4)/(5)

(Top View)

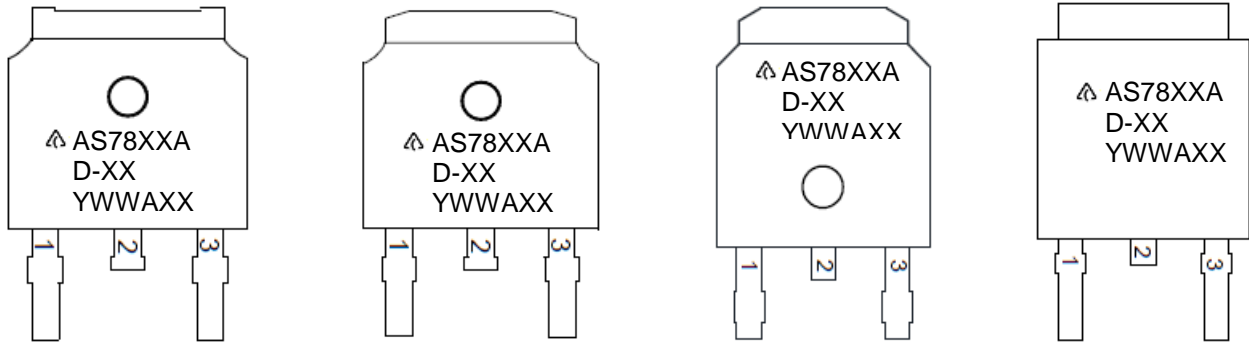

First and Second Lines: Logo and Marking ID
(See Ordering Information)
Third Line: Date Code
Y: Year
WW: Work Week of Molding
A: Assembly House Code
XX: Internal Code

Package Outline Dimensions (All dimensions in mm(inch).)

(1) Package Type: TO-220-3

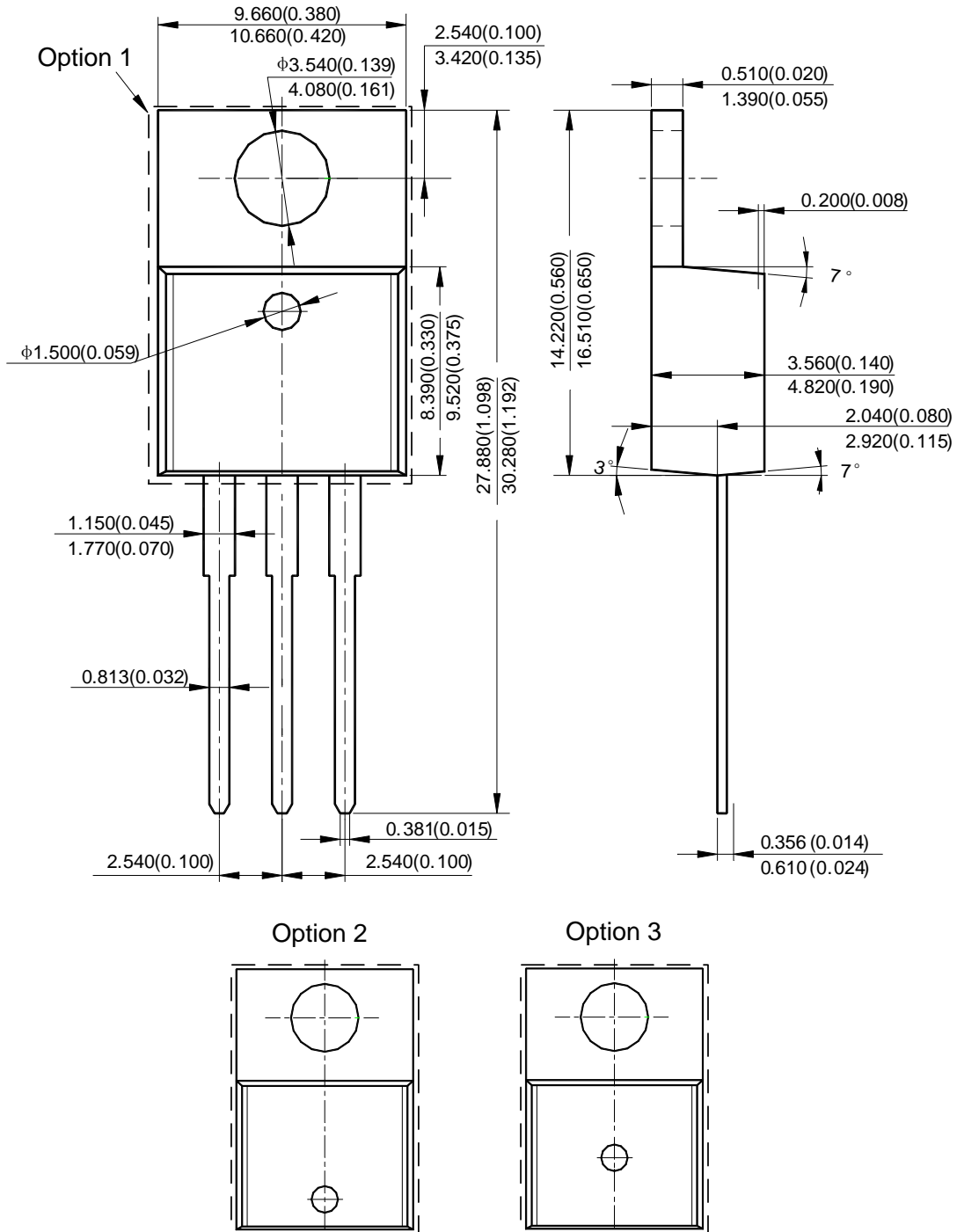

Package Outline Dimensions (Cont. All dimensions in mm(inch).)

(2) Package Type: TO-220-3 (2)



Package Outline Dimensions (Cont. All dimensions in mm(inch).)

(3) Package Type: TO-220F-3

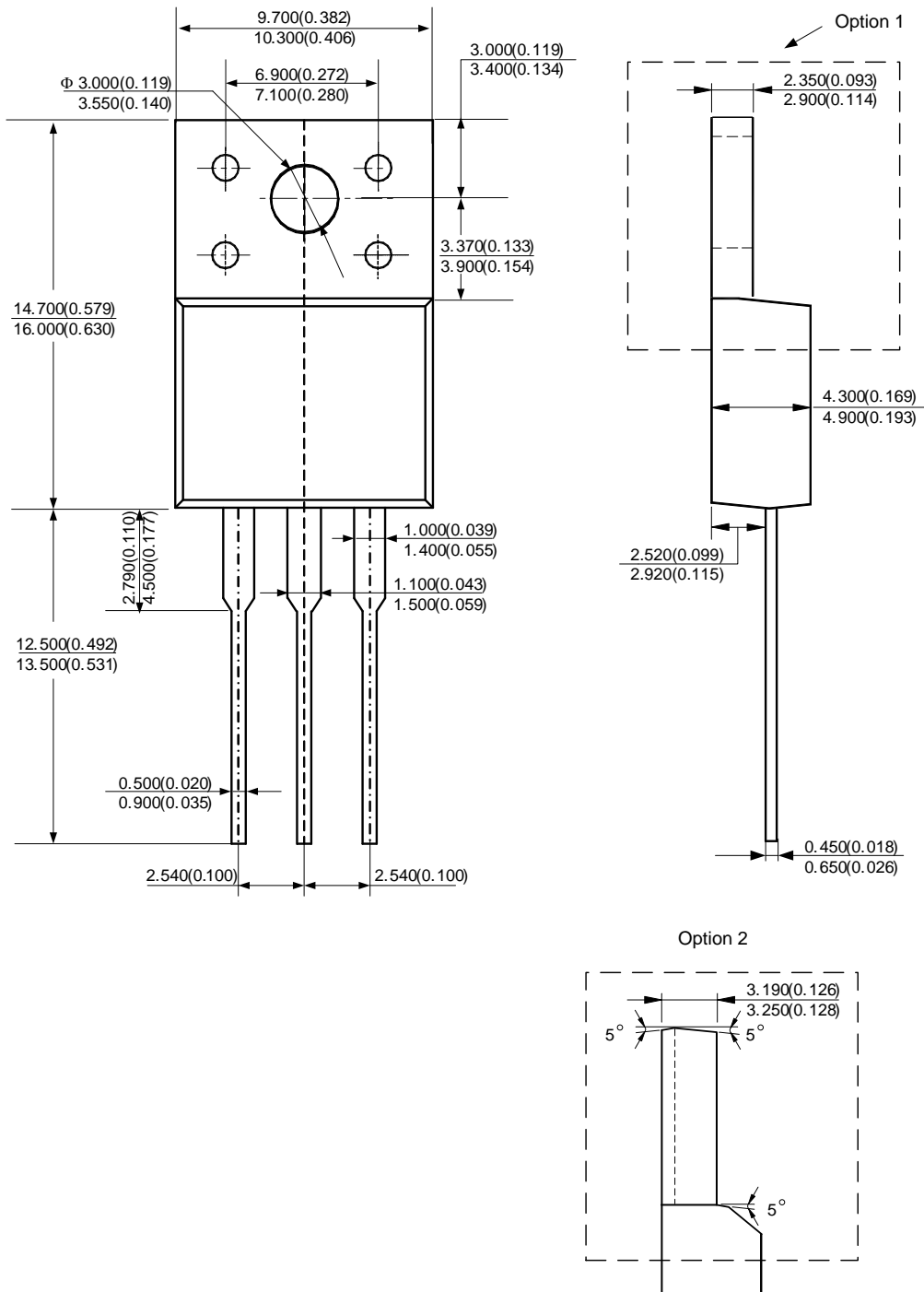

Package Outline Dimensions (Cont. All dimensions in mm(inch).)

(4) Package Type: TO-252-2 (3)

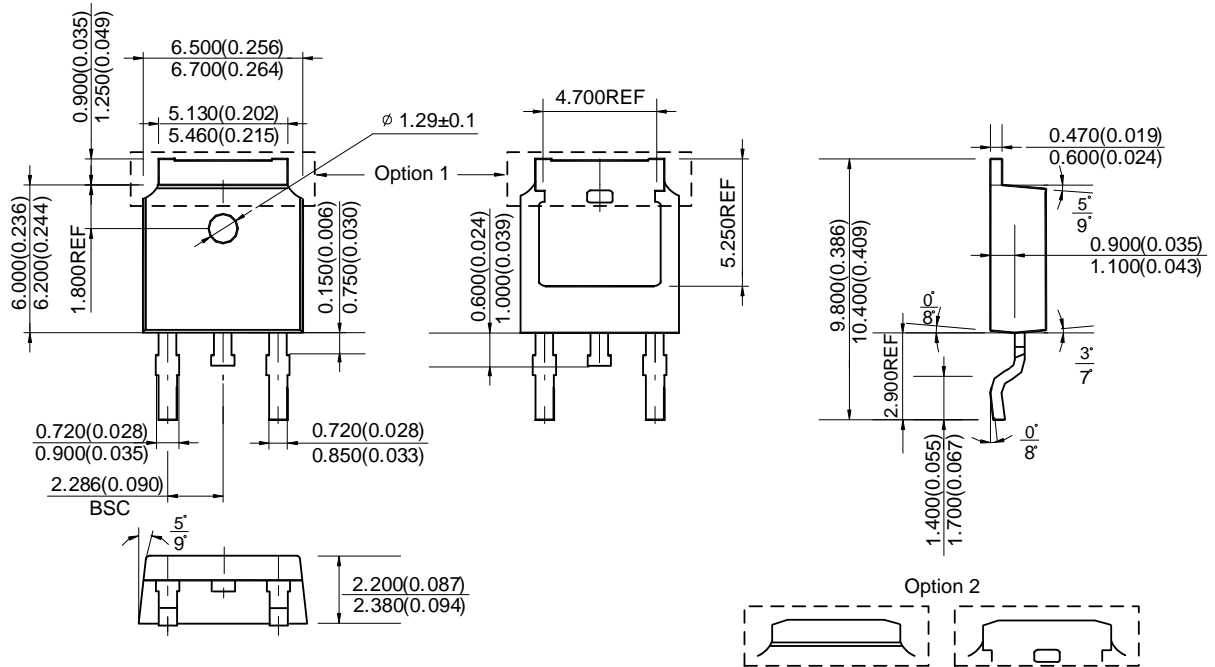

Package Outline Dimensions (Cont. All dimensions in mm(inch).)

(5) Package Type: TO-252-2 (4)

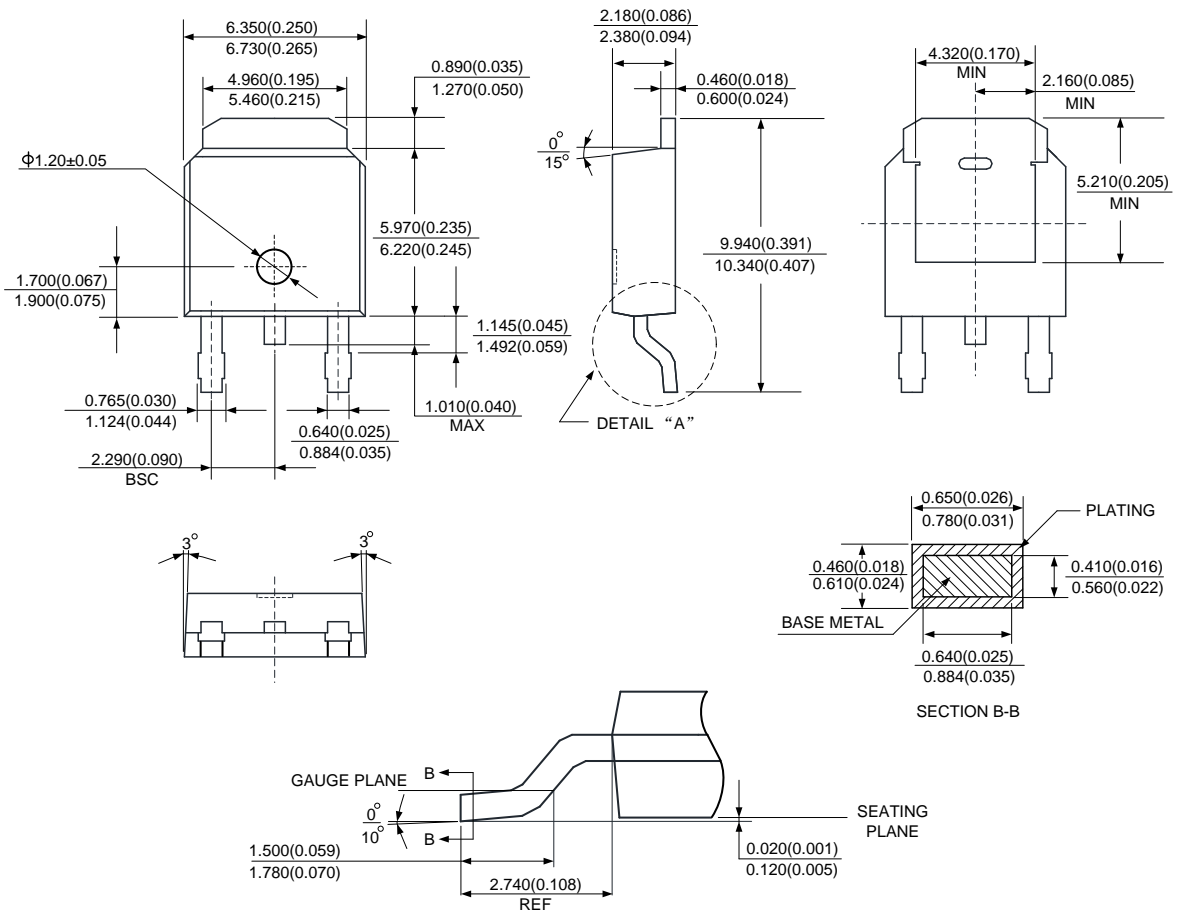

Package Outline Dimensions (Cont. All dimensions in mm(inch).)

(6) Package Type: TO-252-2 (5)

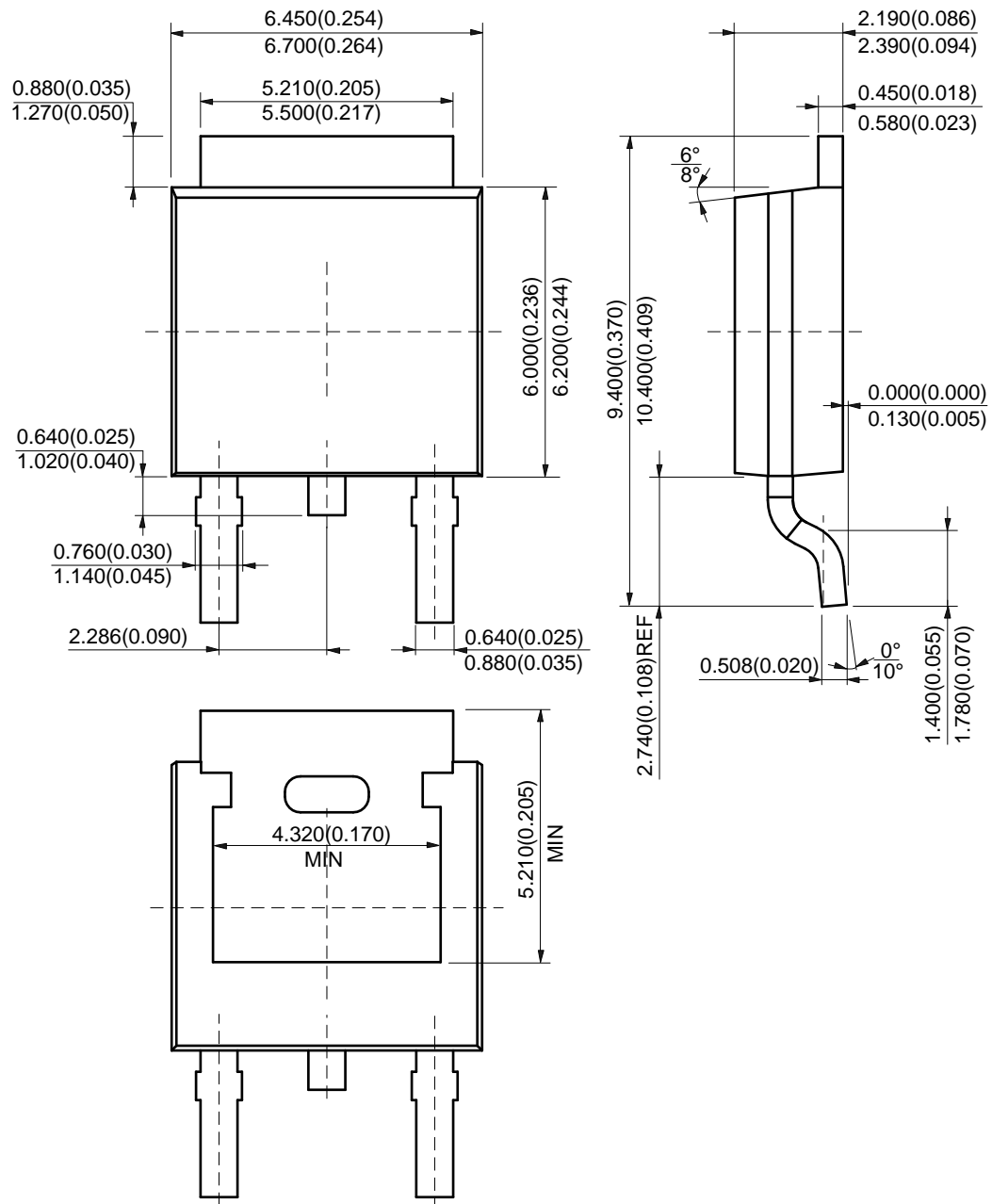

Suggested Pad Layout

(1) Package Type: TO-252-2 (3)

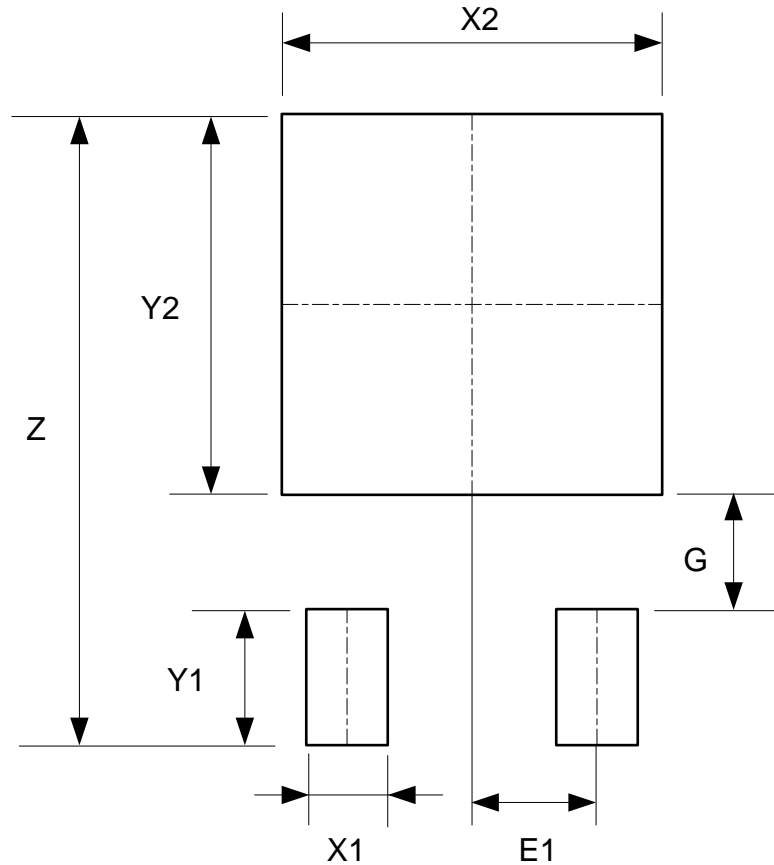

Dimensions	Z (mm)/(inch)	X1 (mm)/(inch)	X2 = Y2 (mm)/(inch)	Y1 (mm)/(inch)	G (mm)/(inch)	E1 (mm)/(inch)
Value	11.600/0.457	1.500/0.059	7.000/0.276	2.500/0.098	2.100/0.083	2.300/0.091

Suggested Pad Layout (Cont.)

(2) Package Type: TO-252-2 (4)

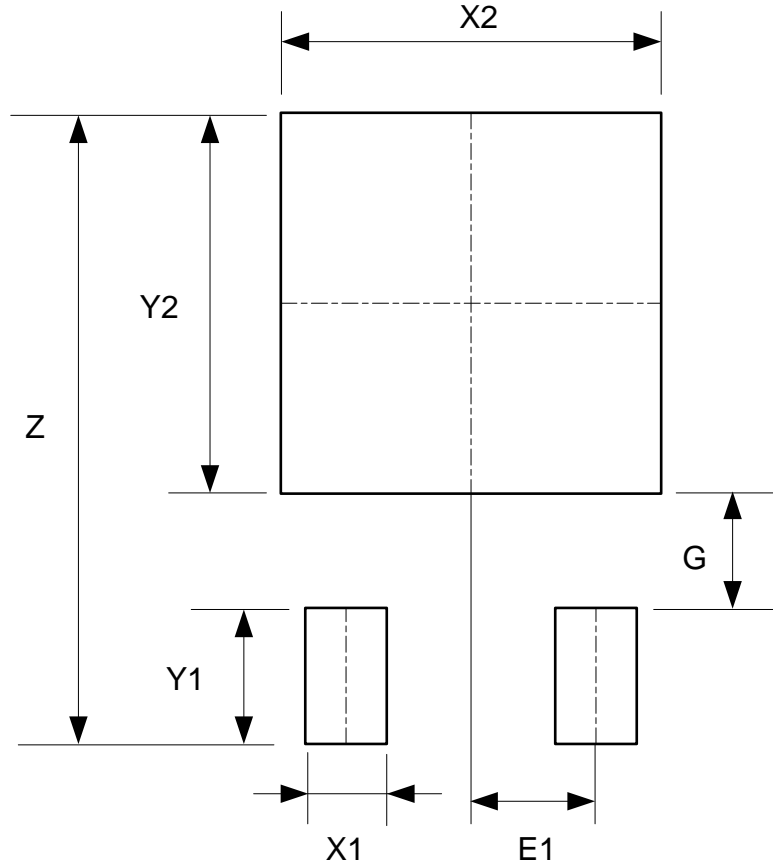

Dimensions	Z (mm)/(inch)	X1 (mm)/(inch)	X2 = Y2 (mm)/(inch)	Y1 (mm)/(inch)	G (mm)/(inch)	E1 (mm)/(inch)
Value	11.600/0.457	1.500/0.059	7.000/0.276	2.500/0.098	2.100/0.083	2.300/0.091

Suggested Pad Layout (Cont.)

(3) Package Type: TO-252-2 (5)

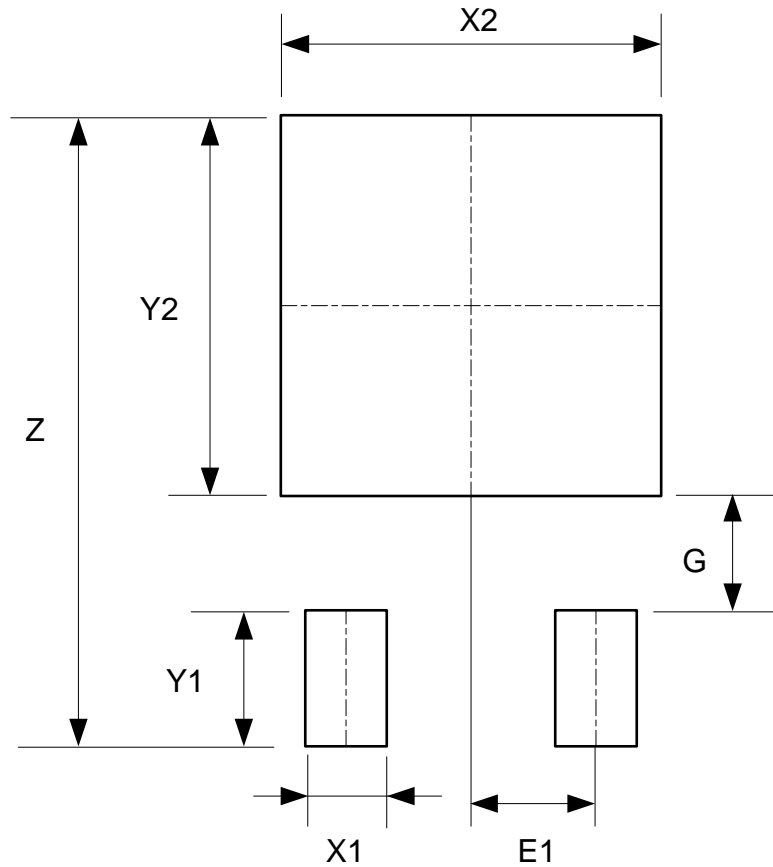

Dimensions	Z (mm)/(inch)	X1 (mm)/(inch)	X2 = Y2 (mm)/(inch)	Y1 (mm)/(inch)	G (mm)/(inch)	E1 (mm)/(inch)
Value	11.600/0.457	1.500/0.059	7.000/0.276	2.500/0.098	2.100/0.083	2.300/0.091

IMPORTANT NOTICE

DIODES INCORPORATED MAKES NO WARRANTY OF ANY KIND, EXPRESS OR IMPLIED, WITH REGARDS TO THIS DOCUMENT, INCLUDING, BUT NOT LIMITED TO, THE IMPLIED WARRANTIES OF MERCHANTABILITY AND FITNESS FOR A PARTICULAR PURPOSE (AND THEIR EQUIVALENTS UNDER THE LAWS OF ANY JURISDICTION).

Diodes Incorporated and its subsidiaries reserve the right to make modifications, enhancements, improvements, corrections or other changes without further notice to this document and any product described herein. Diodes Incorporated does not assume any liability arising out of the application or use of this document or any product described herein; neither does Diodes Incorporated convey any license under its patent or trademark rights, nor the rights of others. Any Customer or user of this document or products described herein in such applications shall assume all risks of such use and will agree to hold Diodes Incorporated and all the companies whose products are represented on Diodes Incorporated website, harmless against all damages.

Diodes Incorporated does not warrant or accept any liability whatsoever in respect of any products purchased through unauthorized sales channel. Should Customers purchase or use Diodes Incorporated products for any unintended or unauthorized application, Customers shall indemnify and hold Diodes Incorporated and its representatives harmless against all claims, damages, expenses, and attorney fees arising out of, directly or indirectly, any claim of personal injury or death associated with such unintended or unauthorized application.

Products described herein may be covered by one or more United States, international or foreign patents pending. Product names and markings noted herein may also be covered by one or more United States, international or foreign trademarks.

This document is written in English but may be translated into multiple languages for reference. Only the English version of this document is the final and determinative format released by Diodes Incorporated.

LIFE SUPPORT

Diodes Incorporated products are specifically not authorized for use as critical components in life support devices or systems without the express written approval of the Chief Executive Officer of Diodes Incorporated. As used herein:

A. Life support devices or systems are devices or systems which:

1. are intended to implant into the body, or
2. support or sustain life and whose failure to perform when properly used in accordance with instructions for use provided in the labeling can be reasonably expected to result in significant injury to the user.

B. A critical component is any component in a life support device or system whose failure to perform can be reasonably expected to cause the failure of the life support device or to affect its safety or effectiveness.

Customers represent that they have all necessary expertise in the safety and regulatory ramifications of their life support devices or systems, and acknowledge and agree that they are solely responsible for all legal, regulatory and safety-related requirements concerning their products and any use of Diodes Incorporated products in such safety-critical, life support devices or systems, notwithstanding any devices- or systems-related information or support that may be provided by Diodes Incorporated. Further, Customers must fully indemnify Diodes Incorporated and its representatives against any damages arising out of the use of Diodes Incorporated products in such safety-critical, life support devices or systems.

Copyright © 2018, Diodes Incorporated

www.diodes.com

Looking for pricing, stock, or lifecycle information?

Click below to explore more details on WIN SOURCE:

 [View AS7805ADTR-E1 on WIN SOURCE](#)

 [Diodes Incorporated](#) Information

Optimize Your Supply Chain with WIN SOURCE Solutions

-  Global Sourcing Solution
-  Obsolete Management
-  Cost Control Management
-  Shortage Management
-  Alternative Solution
-  Excess Inventory Management