



THE DATASHEET OF L78L05A



Three-terminal positive voltage regulator
 OUTPUT CURRENT TO 1.2A
 OUTPUT VOLTAGES OF 5; 6; 8; 9; 12V
 THERMAL OVERLOAD PROTECTION
 SHORT CIRCUIT PROTECTION
 OUTPUT TRANSITION SOA PROTECTION

1、 Absolute Maximum Ratings $T_c=25^{\circ}\text{C}$

Symbol	Parameter	Value	UNIT
VI	Input Voltage	35	V
TOPR	Operating Temperature Range	0 ~ +125	$^{\circ}\text{C}$
TSTG	Storage Temperature Range	-65 ~ +150	$^{\circ}\text{C}$

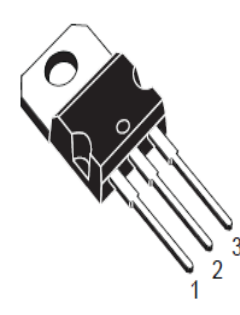

TO-220

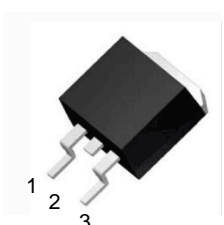

TO-263-3

1 Input 2 Gnd 3 Out

2、 Electrical Characteristics ($T_c=25^{\circ}\text{C}$) Of 7805 (refer to the test circuits, $T_J = -55$ to 150°C $V_I = 10\text{V}$, $I_O = 500\text{ mA}$, $C_I = 0.33\ \mu\text{F}$, $C_O = 0.1\ \mu\text{F}$ unless otherwise specified).

Parameter	Symbol	Test Condition	MIN	TYP	MAX	UNIT
Output Voltage	VO	$T_J = +25^{\circ}\text{C}$	4.8	5	5.2	V
		$I_O = 5\text{mA to } 1\text{A}$, $P_O \leq 15\text{W}$ $V_I = 8\text{V to } 20\text{V}$	4.75	5	5.25	
Line Regulation (Notel)	ΔV_O	$T_J = +25^{\circ}\text{C}$	$V_I = 7\text{V to } 25\text{V}$		100	mV
			$V_I = 8\text{V to } 12\text{V}$		50	
Load Regulation (Notel)	ΔV_O	$T_J = +25^{\circ}\text{C}$ $I_O = 5\text{mA to } 1.2\text{A}$			100	mV
		$T_J = +25^{\circ}\text{C}$ $I_O = 250\text{mA to } 750\text{mA}$			50	
Quiescent Current	IQ	$T_J = +25^{\circ}\text{C}$			6	mA
Quiescent Current Change	ΔI_Q	$I_O = 5\text{mA to } 1\text{A}$			0.5	mA
		$V_I = 8\text{V to } 25\text{V}$			0.8	
Quiescent Current Change	$\Delta V_O/\Delta T$	$I_O = 5\text{mA}$		0.6		mV/ $^{\circ}\text{C}$
Short Circuit Current	ISC	$T_J = +25^{\circ}\text{C}$, $V_I = 35\text{V}$		0.75	1.2	A

3、Electrical Characteristics (Tc=25°C) Of 7806(refer to the test circuits,TJ = -55 to 150°C VI = 11V ,
IO = 500 mA , CI = 0.33 μ F , CO = 0.1 μ F unless otherwise specified)。

Parameter	Symbol	Test Condition	MIN	TYP	MAX	UNIT	
Output Voltage	VO	TJ = +25°C	5.75	6	6.25	V	
		IO = 5mA to 1A, PO ≤ 15W VI = 9V to 21V	5.7	6	6.3		
Line Regulation (Note1)	Δ VO	TJ = +25°C	VI = 8V to 25V			100	mV
			VI = 9V to 13V			50	
Load Regulation (Note1)	Δ VO	TJ = +25°C IO = 5mA to 1.2A			100	mV	
		TJ = +25°C IO = 250mA to 750mA			50		
Quiescent Current	IQ	TJ = +25°C			6	mA	
Quiescent Current Change	Δ IQ	IO = 5mA to 1A			0.5	mA	
		VI = 9V to 25V			0.8		
Quiescent Current Change	Δ VO/Δ T	IO = 5mA		0.7		mV/°C	
Short Circuit Current	ISC	TJ = +25° C, VI = 35V		0.75	1.2	A	

4、Electrical Characteristics (Tc=25°C) Of 7808(refer to the test circuits, Tj = -55 to 150°C VI = 14V, IO = 500 mA, CI = 0.33 μ F, CO = 0.1 μ F unless otherwise specified)。

Parameter	Symbol	Test Condition	MIN	TYP	MAX	UNIT	
Output Voltage	VO	TJ = +25°C	7.7	8	8.3	V	
		IO = 5mA to 1A, PO ≤ 15W VI = 11.5V to 23V	7.6	8	8.4		
Line Regulation (Notel)	Δ VO	TJ = +25°C	VI = 10.5V to 25V			100	mV
			VI = 11V to 17V			50	
Load Regulation (Notel)	Δ VO	TJ = +25°C IO = 5mA to 1.2A			100	mV	
		TJ = +25°C IO = 250mA to 750mA			50		
Quiescent Current	IQ	TJ = +25°C			6	mA	
Quiescent Current Change	Δ IQ	IO = 5mA to 1A			0.5	mA	
		VI = 11.5V to 25V			1		
Quiescent Current Change	Δ Vo/Δ T	IO = 5mA		1		mV/°C	
Short Circuit Current	ISC	TJ = +25° C, VI = 35V		0.75	1.2	A	

5、Electrical Characteristics ($T_c=25^{\circ}\text{C}$) Of 7809(refer to the test circuits, $T_J = -55$ to 150°C $V_I = 15\text{V}$, $I_O = 500\text{ mA}$, $C_I = 0.33\ \mu\text{F}$, $C_O = 0.1\ \mu\text{F}$ unless otherwise specified)。

Parameter	Symbol	Test Condition	MIN	TYP	MAX	UNIT
Output Voltage	V _O	T _J = +25°C	8.64	9	9.36	V
		I _O = 5mA to 1A, P _O ≤ 15W V _I = 11.5V to 26V	8.55	9	9.45	
Line Regulation (Note1)	Δ V _O	T _J = +25°C	V _I = 11.5V to 26V		100	mV
			V _I = 12V to 18V		50	
Load Regulation (Note1)	Δ V _O	T _J = +25°C I _O = 5mA to 1.2A			100	mV
		T _J = +25°C I _O = 250mA to 750mA			50	
Quiescent Current	I _Q	T _J = +25°C			6	mA
Quiescent Current Change	Δ I _Q	I _O = 5mA to 1A			0.5	mA
		V _I = 11.5V to 26V			1	
Quiescent Current Change	Δ V _O /Δ T	I _O = 5mA		1		mV/°C
Short Circuit Current	I _{SC}	T _J = +25° C, V _I = 35V		0.75	1.2	A

6、Electrical Characteristics ($T_c=25^{\circ}\text{C}$) Of 7812 (refer to the test circuits, $T_J = -55$ to 150°C $V_I = 19\text{V}$, $I_O = 500\text{ mA}$, $C_I = 0.33\ \mu\text{F}$, $C_O = 0.1\ \mu\text{F}$ unless otherwise specified)。

Parameter	Symbol	Test Condition	MIN	TYP	MAX	UNIT
Output Voltage	V _O	T _J = +25°C	11.5	12	12.5	V
		I _O = 5mA to 1A, P _O ≤ 15W V _I =15.5V to 27V	11.4	12	12.6	
Line Regulation (Note1)	Δ V _O	T _J = +25°C	V _I = 14.5V to 30V		100	mV
			V _I = 16V to 22V		50	
Load Regulation (Note1)	Δ V _O	T _J = +25°C I _O = 5mA to 1.2A			100	mV
		T _J = +25°C I _O = 250mA to 750mA			50	
Quiescent Current	I _Q	T _J = +25°C			6	mA
Quiescent Current Change	Δ I _Q	I _O = 5mA to 1A			0.5	mA
		V _I = 15V to 30V			1	
Quiescent Current Change	Δ V _O /Δ T	I _O = 5mA		1.5		mV/°C
Short Circuit Current	I _{SC}	T _J = +25° C, V _I = 35V		0.75	1.2	A

7、Typical Characteristics

Figure 1: Dropout Voltage vs Junction Temperature

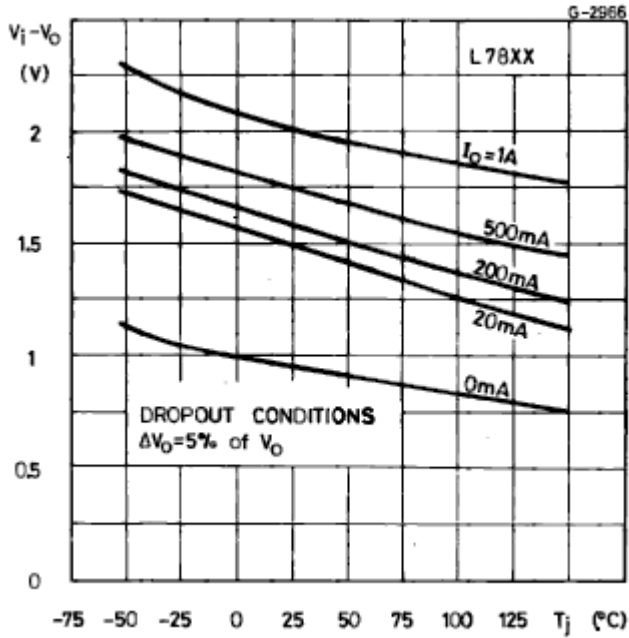

Figure 2: Peak Output Current vs Input/output Differential Voltage

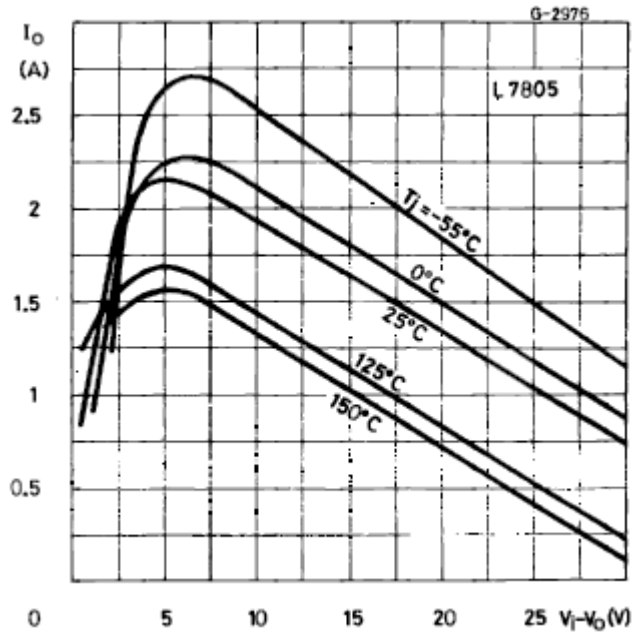

Figure3: Supply Voltage Rejection vs Frequency

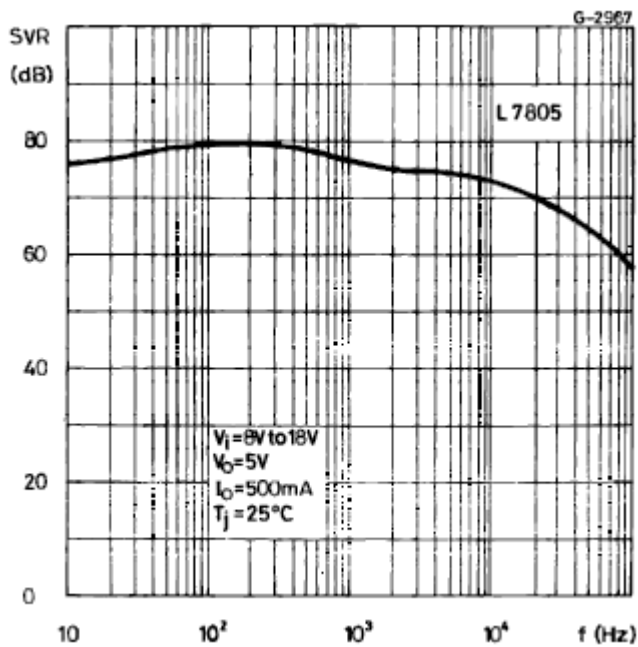

Figure 4: Quiescent Current vs Junction

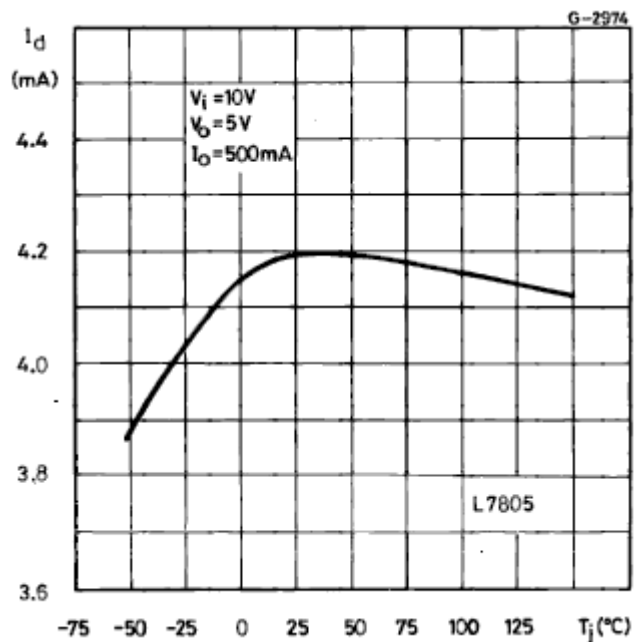

Figure 5: Output Voltage vs Junction Temperature

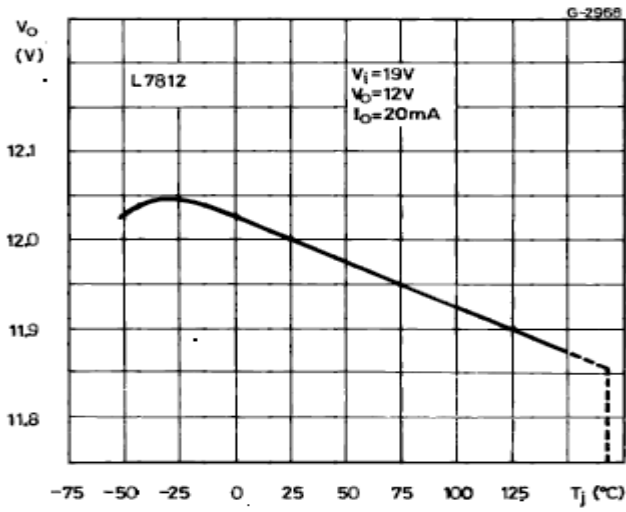

Figure 6: Load Transient Response

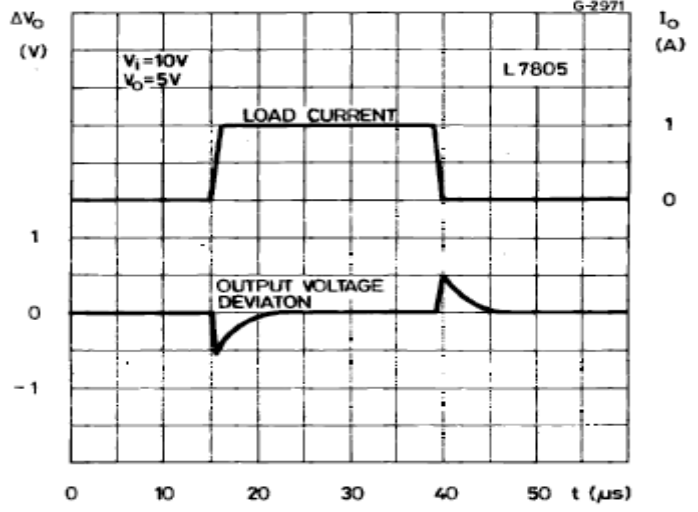

Figure 7: Output Impedance vs Frequency

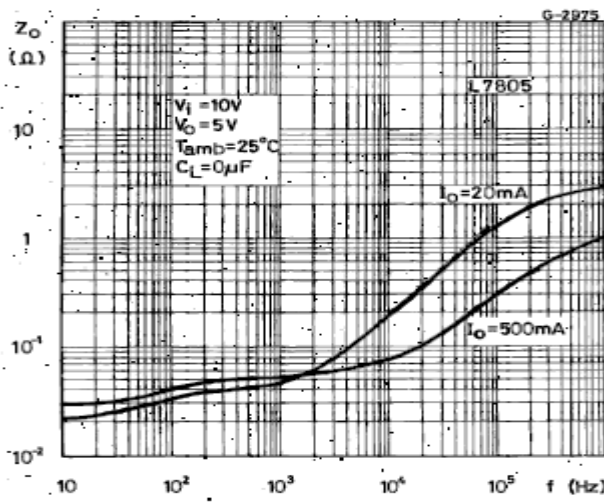

Figure 8: Line Transient Response

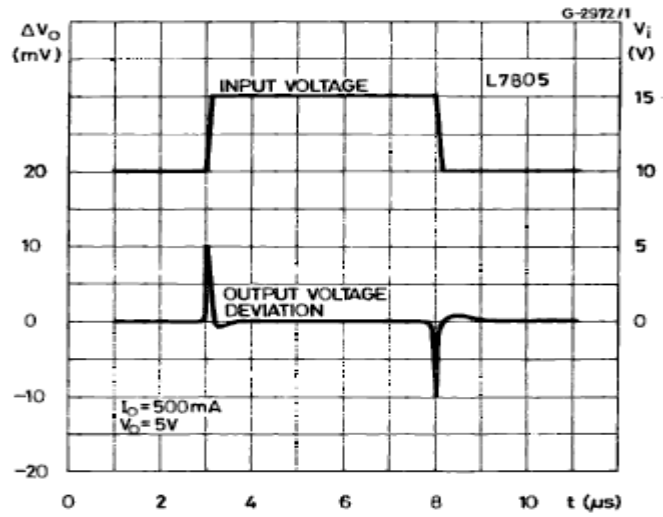
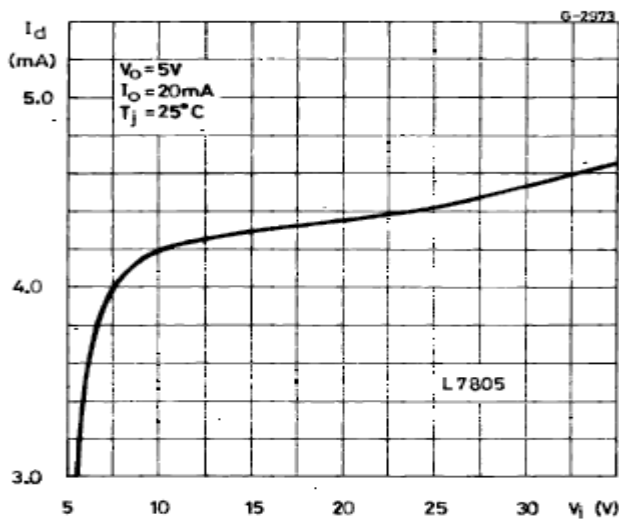

Figure 9: Quiescent Current vs Input Voltage



8、Package Demensions

T0-263-3

T0-263封装尺寸:

UNIT: mm

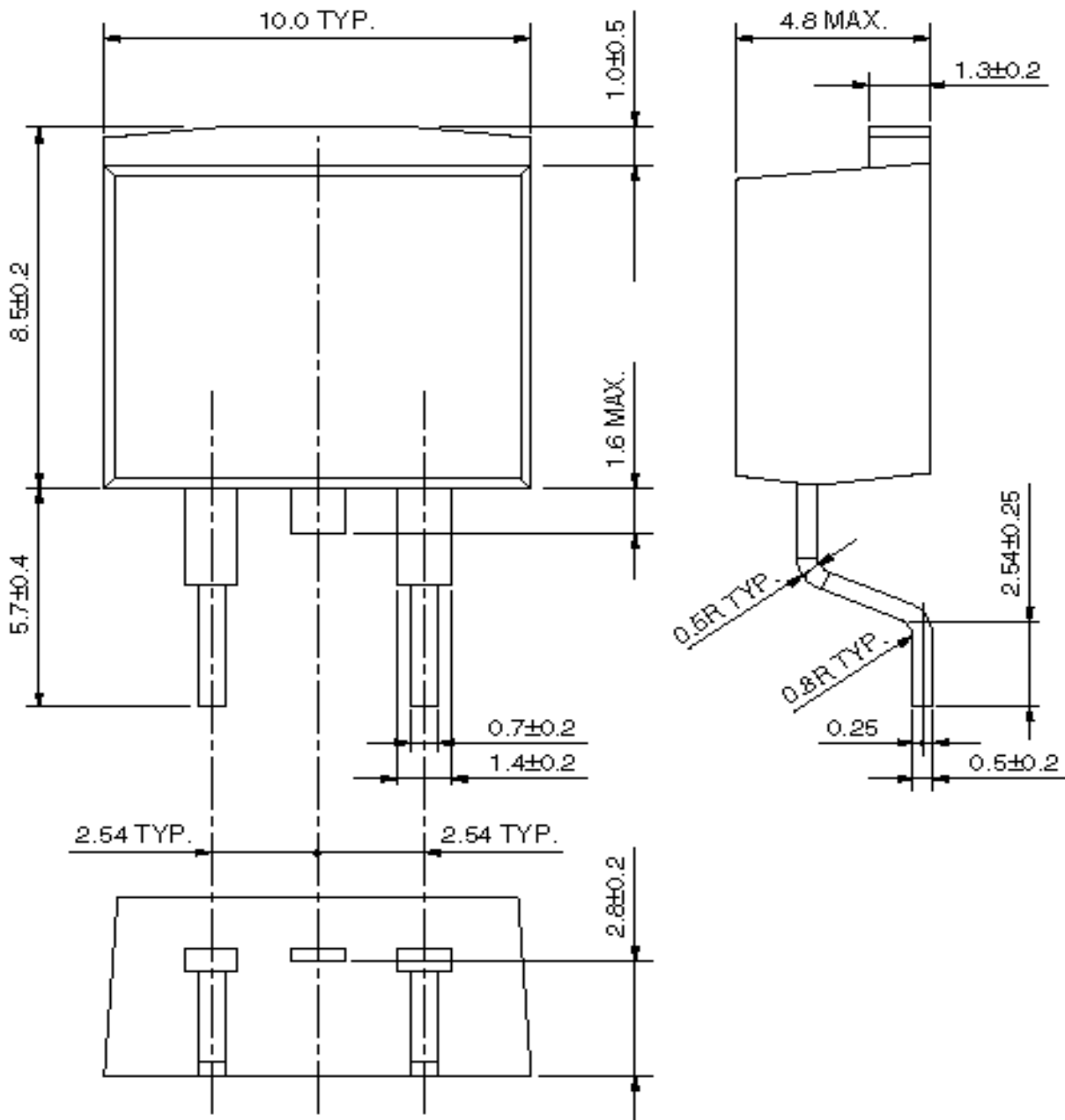

: The area without solder plated

9、Package Demensions

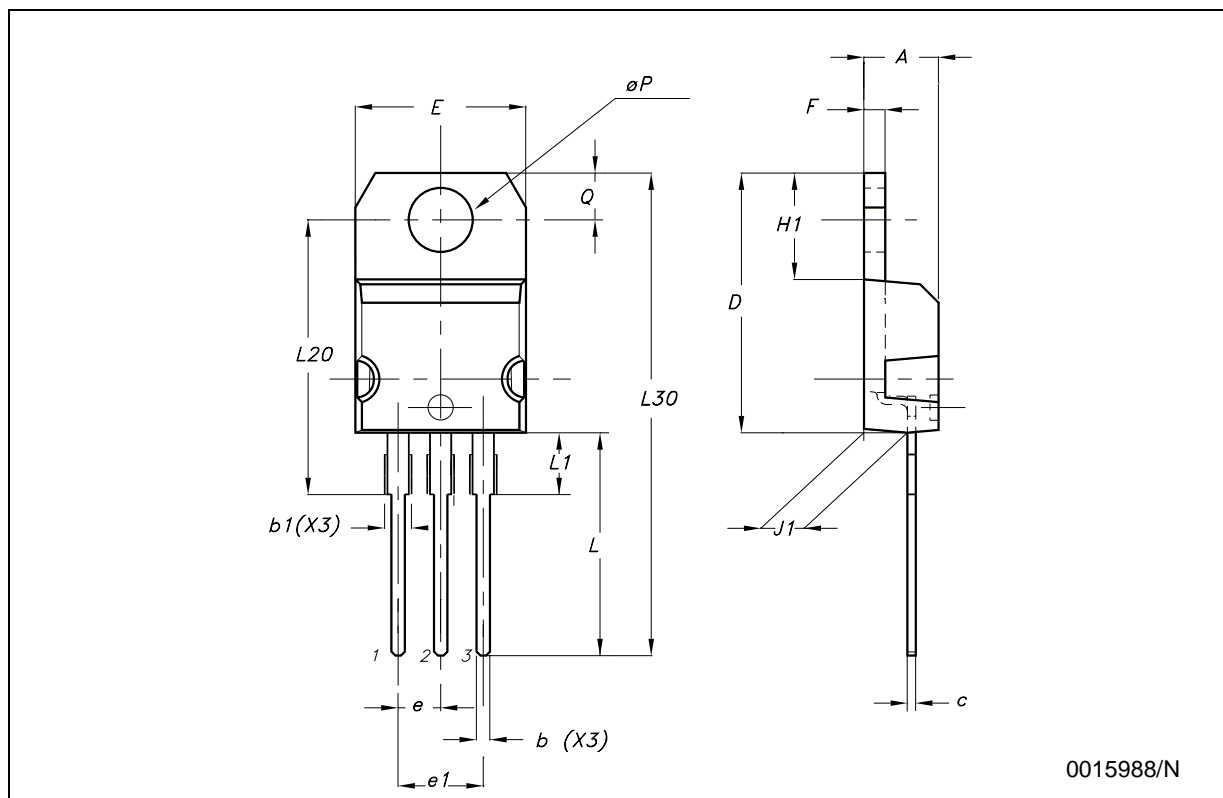

T0-220

DIM.	mm.			inch		
	MIN.	TYP.	MAX.	MIN.	TYP.	MAX.
A	4.40		4.60	0.173		0.181
b	0.61		0.88	0.024		0.034
b1	1.15		1.70	0.045		0.067
c	0.49		0.70	0.019		0.027
D	15.25		15.75	0.600		0.620
E	10.0		10.40	0.393		0.409
e	2.4		2.7	0.094		0.106
e1	4.95		5.15	0.194		0.203
F	1.23		1.32	0.048		0.051
H1	6.2		6.6	0.244		0.260
J1	2.40		2.72	0.094		0.107
L	13.0		14.0	0.511		0.551
L1	3.5		3.93	0.137		0.154
L20		16.4			0.645	
L30		28.9			1.138	
φP	3.75		3.85	0.147		0.151
Q	2.65		2.95	0.104		0.116









Looking for pricing, stock, or lifecycle information?

Click below to explore more details on WIN SOURCE:

-  [View L78L05A on WIN SOURCE](#)
-  [NXP / Nexperia Information](#)

Optimize Your Supply Chain with WIN SOURCE Solutions

-  Global Sourcing Solution
-  Obsolete Management
-  Cost Control Management
-  Shortage Management
-  Alternative Solution
-  Excess Inventory Management