



**THE DATASHEET OF
LT1521CS8#PBF**



300mA Low Dropout Regulators with Micropower Quiescent Current and Shutdown

FEATURES

- Dropout Voltage: 0.5V
- Output Current: 300mA
- Quiescent Current: 12 μ A
- No Protection Diodes Needed
- Adjustable Output from 3.8V to 20V
- Fixed Output Voltages: 3V, 3.3V, 5V
- Controlled Quiescent Current in Dropout
- Shutdown $I_Q = 6\mu$ A
- Reverse Battery Protection
- No Reverse Current
- Thermal Limiting

APPLICATIONS

- Low Current Regulator
- Regulator for Battery-Powered Systems
- Post Regulator for Switching Supplies

DESCRIPTION

The LT[®]1521/LT1521-3/LT1521-3.3/LT1521-5 are low dropout regulators with micropower quiescent current and shutdown. These devices are capable of supplying 300mA of output current with a dropout voltage of 0.5V. Designed for use in battery-powered systems, the low quiescent current, 12 μ A operating and 6 μ A in shutdown, makes them an ideal choice. The quiescent current is well controlled; it does not rise in dropout as it does with many other low dropout PNP regulators.

Other features of the LT1521/LT1521-3/LT1521-3.3/LT1521-5 include the ability to operate with very small output capacitors. They are stable with only 1.5 μ F on the output while most older devices require between 10 μ F and 100 μ F for stability. Small ceramic capacitors can be used, enhancing manufacturability. Also, the input may be connected to voltages lower than the output voltage, including negative voltages, without reverse current flow from output to input. This makes the LT1521 series ideal for backup power situations where the output is held high and the input is low or reversed. Under these conditions only 5 μ A will flow from the output pin to ground.

 LTC and LT are registered trademarks of Linear Technology Corporation.

TYPICAL APPLICATION

5V Battery-Powered Supply with Shutdown



Dropout Voltage



LT1521/LT1521-3 LT1521-3.3/LT1521-5

ABSOLUTE MAXIMUM RATINGS (Note 1)

Input Voltage $\pm 20V^*$
 Output Pin Reverse Current 10mA
 Adjust Pin Current 10mA
 Shutdown Pin Input Voltage (Note 1) 6.5V, -0.6V
 Shutdown Pin Input Current (Note 1) 5mA
 Output Short-Circuit Duration Indefinite

Storage Temperature Range -65°C to 150°C
 Operating Junction Temperature Range (Note 2)
 Commercial 0°C to 125°C
 Industrial -40°C to 125°C
 Lead Temperature (Soldering, 10 sec) 300°C

*For applications requiring input voltage ratings greater than 20V, contact the factory.

PACKAGE/ORDER INFORMATION

 <p>MS8 PACKAGE 8-LEAD PLASTIC MSOP</p> <p>*PIN 2 = SENSE FOR LT1521-3/ LT1521-3.3/LT1521-5 PIN 2 = ADJ FOR LT1521</p> <p>$T_{JMAX} = 125^{\circ}\text{C}$, $\theta_{JA} = 125^{\circ}\text{C}/\text{W}$</p>	 <p>S8 PACKAGE 8-LEAD PLASTIC SO</p> <p>*PIN 2 = SENSE FOR LT1521-3/LT1521-3.3/LT1521-5 = ADJ FOR LT1521</p> <p>$T_{JMAX} = 125^{\circ}\text{C}$, $\theta_{JA} = 70^{\circ}\text{C}/\text{W}$ SEE THE APPLICATIONS INFORMATION SECTION</p>	 <p>ST PACKAGE 3-LEAD PLASTIC SOT-223</p> <p>$T_{JMAX} = 125^{\circ}\text{C}$, $\theta_{JA} = 50^{\circ}\text{C}/\text{W}$ SEE THE APPLICATIONS INFORMATION SECTION</p>
ORDER PART NUMBER	ORDER PART NUMBER	ORDER PART NUMBER
LT1521CMS8 LT1521CMS8-3 LT1521CMS8-3.3 LT1521CMS8-5	LT1521CS8 LT1521CS8-3 LT1521CS8-3.3 LT1521CS8-5 LT1521IS8 LT1521IS8-3 LT1521IS8-3.3 LT1521IS8-5	LT1521CST-3 LT1521CST-3.3 LT1521CST-5 LT1521IST-3 LT1521IST-3.3 LT1521IST-5
MS8 PART MARKING	S8 PART MARKING	ST PART MARKING
LTEZ LTFB LTDU LTFA	1521 15211 15213 152113 152133 1521133 15215 152115	15213 152113 152133 1521133 15215 152115

Consult LTC Marketing for parts specified with wider operating temperature ranges.

ELECTRICAL CHARACTERISTICS The ● denotes the specifications which apply over the full operating temperature range, otherwise specifications are at $T_A = 25^\circ\text{C}$.

PARAMETER	CONDITIONS	MIN	TYP	MAX	UNITS
Regulated Output Voltage (Note 4)	LT1521-3 $V_{IN} = 3.5\text{V}$, $I_{OUT} = 1\text{mA}$, $T_J = 25^\circ\text{C}$ $4\text{V} < V_{IN} < 20\text{V}$, $1\text{mA} < I_{OUT} < 300\text{mA}$ ●	2.950 2.900	3.000 3.000	3.050 3.100	V V
	LT1521-3.3 $V_{IN} = 3.8\text{V}$, $I_{OUT} = 1\text{mA}$, $T_J = 25^\circ\text{C}$ $4.3\text{V} < V_{IN} < 20\text{V}$, $1\text{mA} < I_{OUT} < 300\text{mA}$ ●	3.250 3.200	3.300 3.300	3.350 3.400	V V
	LT1521-5 $V_{IN} = 5.5\text{V}$, $I_{OUT} = 1\text{mA}$, $T_J = 25^\circ\text{C}$ $6\text{V} < V_{IN} < 20\text{V}$, $1\text{mA} < I_{OUT} < 300\text{mA}$ ●	4.925 4.850	5.000 5.000	5.075 5.150	V V
	LT1521 (Note 5) $V_{IN} = 4.3\text{V}$, $I_{OUT} = 1\text{mA}$, $T_J = 25^\circ\text{C}$ $4.8\text{V} < V_{IN} < 20\text{V}$, $1\text{mA} < I_{OUT} < 300\text{mA}$ ●	3.695 3.640	3.750 3.750	3.805 3.860	V V
Line Regulation	LT1521-3 $\Delta V_{IN} = 4.5$ to 20V , $I_{OUT} = 1\text{mA}$ ●		1.5	20	mV
	LT1521-3.3 $\Delta V_{IN} = 4.8$ to 20V , $I_{OUT} = 1\text{mA}$ ●		1.5	20	mV
	LT1521-5 $\Delta V_{IN} = 5.5$ to 20V , $I_{OUT} = 1\text{mA}$ ●		1.5	20	mV
	LT1521 (Note 5) $\Delta V_{IN} = 4.3$ to 20V , $I_{OUT} = 1\text{mA}$ ●		1.5	20	mV
Load Regulation	LT1521-3 $\Delta I_{LOAD} = 1\text{mA}$ to 300mA , $T_J \leq 25^\circ\text{C}$		-20	-30	mV
	LT1521-3.3 $\Delta I_{LOAD} = 1\text{mA}$ to 300mA , $T_J \leq 25^\circ\text{C}$		-20	-30	mV
	LT1521-5 $\Delta I_{LOAD} = 1\text{mA}$ to 300mA , $T_J \leq 25^\circ\text{C}$		-25	-45	mV
	LT1521 (Note 5) $\Delta I_{LOAD} = 1\text{mA}$ to 300mA , $T_J \leq 25^\circ\text{C}$		-20	-30	mV
	LT1521-3 $\Delta I_{LOAD} = 1\text{mA}$ to 300mA , $T_J > 25^\circ\text{C}$		-20	-55	mV
	LT1521-3.3 $\Delta I_{LOAD} = 1\text{mA}$ to 300mA , $T_J > 25^\circ\text{C}$		-20	-55	mV
	LT1521-5 $\Delta I_{LOAD} = 1\text{mA}$ to 300mA , $T_J > 25^\circ\text{C}$		-25	-75	mV
	LT1521 (Note 5) $\Delta I_{LOAD} = 1\text{mA}$ to 300mA , $T_J > 25^\circ\text{C}$		-20	-55	mV
Dropout Voltage (Note 6)	$I_{LOAD} = 1\text{mA}$, $T_J = 25^\circ\text{C}$ $I_{LOAD} = 1\text{mA}$ ●		130	170 250	mV mV
	$I_{LOAD} = 50\text{mA}$, $T_J = 25^\circ\text{C}$ $I_{LOAD} = 50\text{mA}$ ●		290	350 450	mV mV
	$I_{LOAD} = 100\text{mA}$, $T_J = 25^\circ\text{C}$ $I_{LOAD} = 100\text{mA}$ ●		350	420 550	mV mV
	$I_{LOAD} = 150\text{mA}$, $T_J = 25^\circ\text{C}$ $I_{LOAD} = 150\text{mA}$ ●		400	470 600	mV mV
	$I_{LOAD} = 300\text{mA}$, $T_J = 25^\circ\text{C}$ $I_{LOAD} = 300\text{mA}$ ●		500	600 750	mV mV
	Ground Pin Current (Note 7)	$I_{LOAD} = 0\text{mA}$ ●		12	25
$I_{LOAD} = 1\text{mA}$ ●			65	100	μA
$I_{LOAD} = 10\text{mA}$ ●			300	450	μA
$I_{LOAD} = 50\text{mA}$ ●			0.8	1.5	mA
$I_{LOAD} = 100\text{mA}$ ●			1.4	2.5	mA
$I_{LOAD} = 150\text{mA}$ ●			2.2	4.0	mA
$I_{LOAD} = 300\text{mA}$ ●			6.5	12.0	mA
Adjust Pin Bias Current (Notes 5, 8)	$T_J = 25^\circ\text{C}$		50	100	nA
Shutdown Threshold	$V_{OUT} = \text{Off to On}$ ●		1.20	2.80	V
	$V_{OUT} = \text{On to Off}$ ●	0.25	0.75		V
Shutdown Pin Current (Note 9)	$V_{SHDN} = 0\text{V}$ ●		2.0	5.0	μA
Quiescent Current in Shutdown (Note 10)	$V_{IN} = V_{OUT} (\text{NOMINAL}) + 1\text{V}$, $V_{SHDN} = 0\text{V}$ ●		6	12	μA
Ripple Rejection	$V_{IN} - V_{OUT} = 1\text{V}(\text{Avg})$, $V_{RIPPLE} = 0.5\text{V}_{P-P}$, $f_{RIPPLE} = 120\text{Hz}$, $I_{LOAD} = 150\text{mA}$	50	58		dB
Current Limit	$V_{IN} - V_{OUT} = 7\text{V}$, $T_J = 25^\circ\text{C}$		400	800	mA
	$V_{IN} = V_{OUT} (\text{NOMINAL}) + 1.5\text{V}$, $\Delta V_{OUT} = -0.1\text{V}$ ●	320	400		mA

LT1521/LT1521-3 LT1521-3.3/LT1521-5

ELECTRICAL CHARACTERISTICS

The ● denotes the specifications which apply over the full operating temperature range, otherwise specifications are at $T_A = 25^\circ\text{C}$.

PARAMETER	CONDITIONS	MIN	TYP	MAX	UNITS
Input Reverse Leakage Current	$V_{IN} = -20\text{V}$, $V_{OUT} = 0\text{V}$	●		1.0	mA
Reverse Output Current (Note 11)	LT1521-3 $V_{OUT} = 3\text{V}$, $V_{IN} < 3\text{V}$, $T_J = 25^\circ\text{C}$		5	10	μA
	LT1521-3.3 $V_{OUT} = 3.3\text{V}$, $V_{IN} < 3.3\text{V}$, $T_J = 25^\circ\text{C}$		5	10	μA
	LT1521-5 $V_{OUT} = 5\text{V}$, $V_{IN} < 5\text{V}$, $T_J = 25^\circ\text{C}$		5	10	μA
	LT1521 (Note 5) $V_{OUT} = 3.8\text{V}$, $V_{IN} < 3.75\text{V}$, $T_J = 25^\circ\text{C}$		5	10	μA

Note 1: Absolute Maximum Ratings are those values beyond which the life of a device may be impaired.

Note 2: The shutdown pin input voltage rating is required for a low impedance source. Internal protection devices connected to the shutdown pin will turn on and clamp the pin to approximately 7V or -0.6V. This range allows the use of 5V logic devices to drive the pin directly. For high impedance sources or logic running on supply voltages greater than 5.5V, the maximum current driven into the shutdown pin must be limited to less than 5mA.

Note 3: For junction temperatures greater than 110°C , a minimum load of 1mA is recommended. For $T_J > 110^\circ\text{C}$ and $I_{OUT} < 1\text{mA}$, output voltage may increase by 1%.

Note 4: Operating conditions are limited by maximum junction temperature. The regulated output voltage specification will not apply for all possible combinations of input voltage and output current. When operating at maximum input voltage, the output current range must be limited. When operating at maximum output current, the input voltage range must be limited.

Note 5: The LT1521 (adjustable version) is tested and specified with the adjust pin connected to the output pin.

Note 6: Dropout voltage is the minimum input/output voltage required to maintain regulation at the specified output current. In dropout the output voltage will be equal to: $(V_{IN} - V_{DROPOUT})$

Note 7: Ground pin current is tested with $V_{IN} = V_{OUT}$ (nominal) and a current source load. This means the device is tested while operating in its dropout region. This is the worst-case ground pin current. The ground pin current will decrease slightly at higher input voltages.

Note 8: Adjust pin bias current flows into the adjust pin.

Note 9: Shutdown pin current at $V_{SHDN} = 0\text{V}$ flows out of the shutdown pin.

Note 10: Quiescent current in shutdown is equal to the total sum of the shutdown pin current ($2\mu\text{A}$) and the ground pin current ($4\mu\text{A}$).

Note 11: Reverse output current is tested with the input pin grounded and the output pin forced to the rated output voltage. This current flows into the output pin and out of the ground pin.

TYPICAL PERFORMANCE CHARACTERISTICS

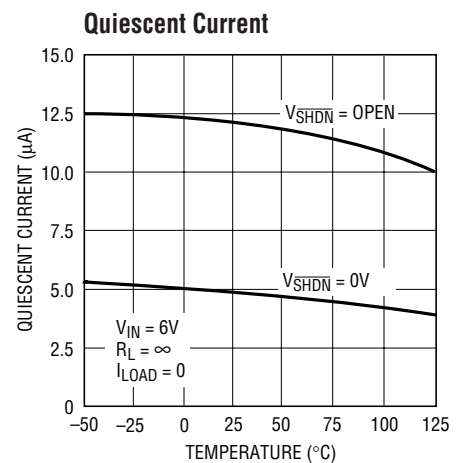
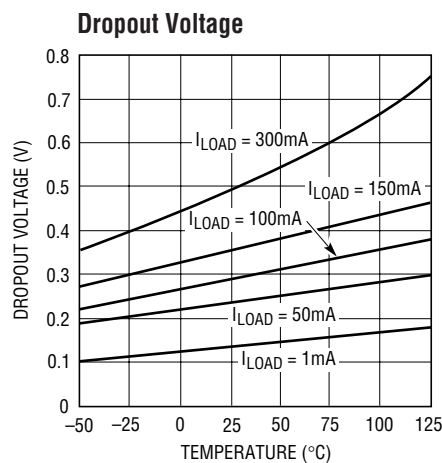
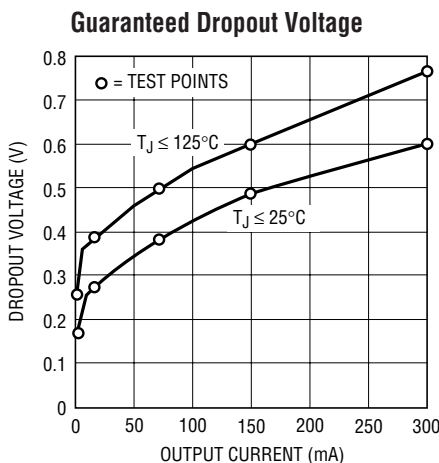

TYPICAL PERFORMANCE CHARACTERISTICS

**LT1521-3
Output Voltage**



LT1521 • TPC04

**LT1521-3.3
Output Voltage**

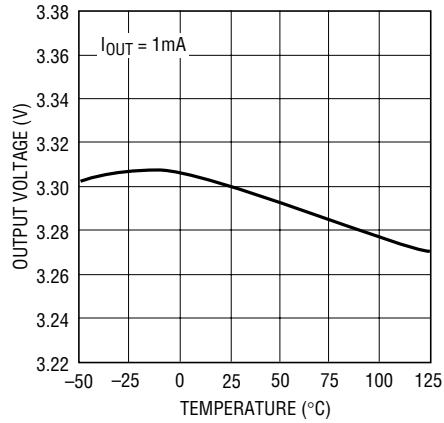

LT1521 • TPC05

**LT1521-5
Output Voltage**



LT1521 • TPC06

**LT1521
Adjust Pin Voltage**

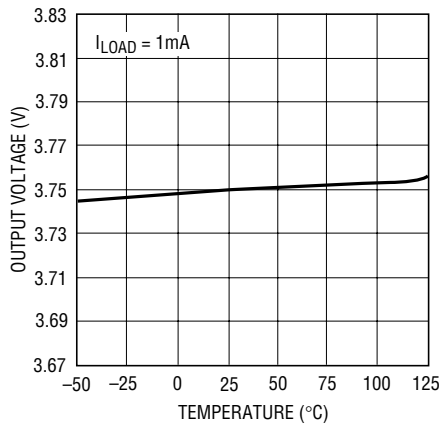

LT1521 • TPC07

**LT1521-3
Quiescent Current**

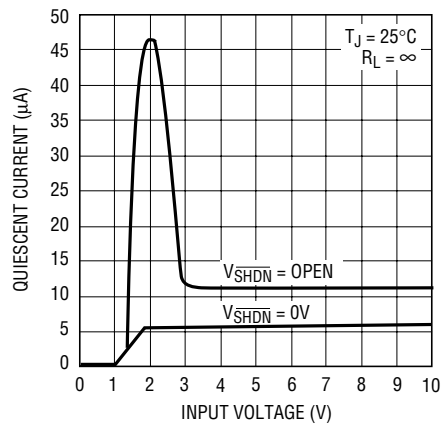

LT1521 • TPC08

**LT1521-3.3
Quiescent Current**



LT1521 • TPC09

**LT1521-5
Quiescent Current**

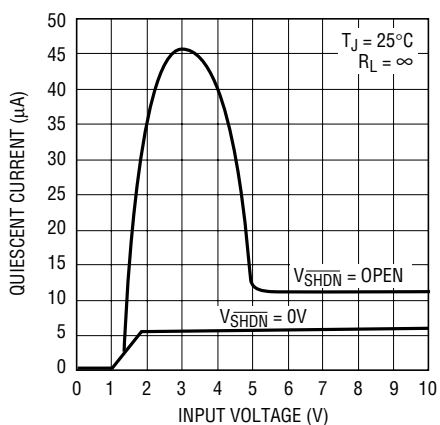

LT1521 • TPC10

**LT1521
Quiescent Current**

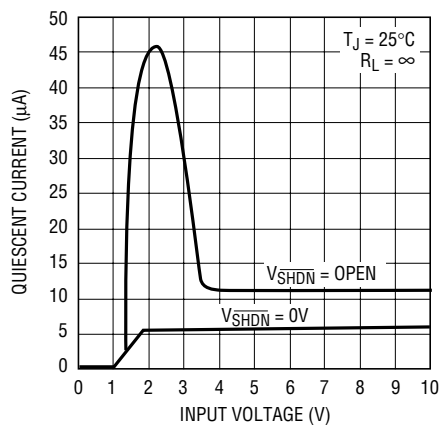

LT1521 • TPC11

**LT1521-3
Ground Pin Current**

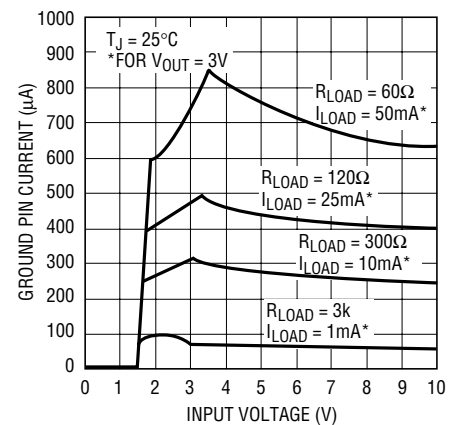

LT1521 • TPC12

TYPICAL PERFORMANCE CHARACTERISTICS

**LT1521-3
 Ground Pin Current**



LT1521 • TPC13

**LT1521-3.3
 Ground Pin Current**



LT1521 • TPC14

**LT1521-3.3
 Ground Pin Current**



LT1521 • TPC15

**LT1521-5
 Ground Pin Current**



LT1521 • TPC16

**LT1521-5
 Ground Pin Current**



LT1521 • TPC17

**LT1521
 Ground Pin Current**



LT1521 • TPC18

**LT1521
 Ground Pin Current**

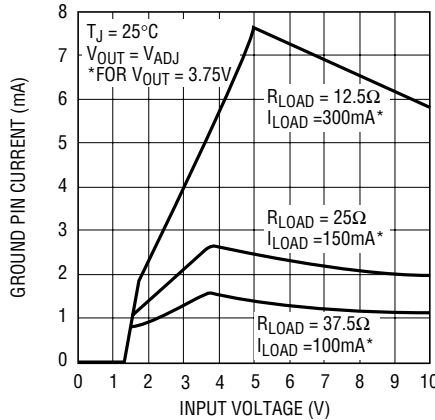

LT1521 • TPC19

Ground Pin Current

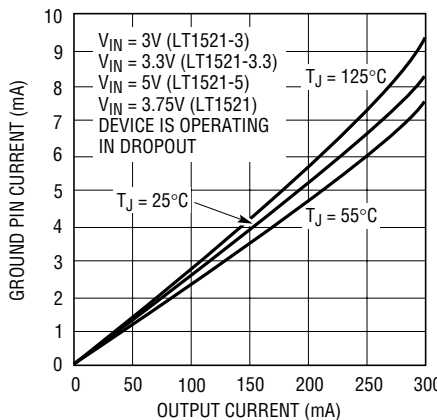

LT1521 • TPC20

**Shutdown Pin Threshold
 (On-to-Off)**

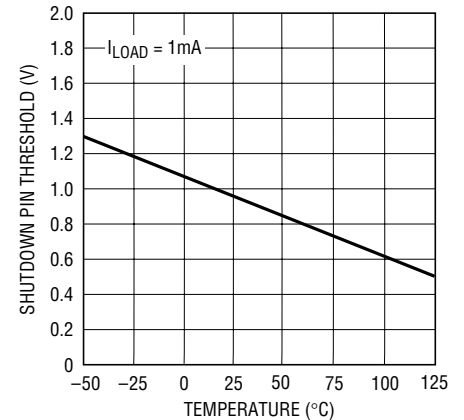

LT1521 • TPC21

TYPICAL PERFORMANCE CHARACTERISTICS

Shutdown Pin Threshold (Off-to-On)



LT1521 • TPC22

Shutdown Pin Current



LT1521 • TPC23

Shutdown Pin Input Current



LT1521 • TPC24

Adjust Pin Bias Current



LT1521 • TPC25

Reverse Output Current

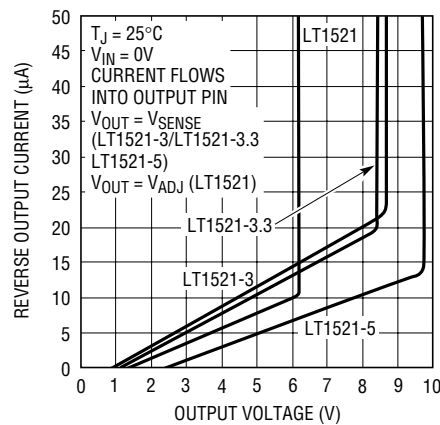

LT1521 • TPC26

Current Limit

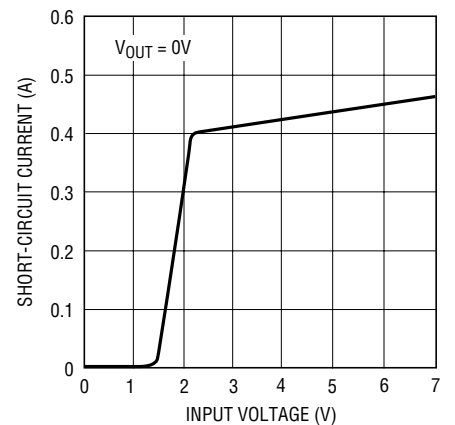

LT1521 • TPC27

Current Limit



LT1521 • TPC28

Reverse Output Current

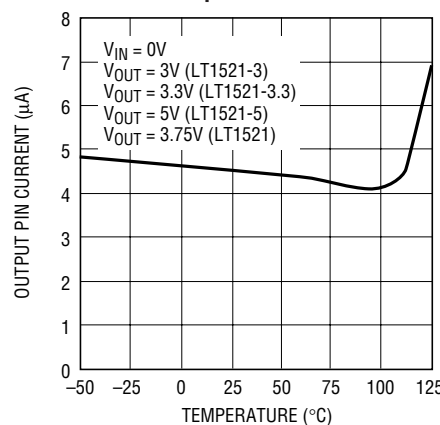

LT1521 • TPC29

Ripple Rejection

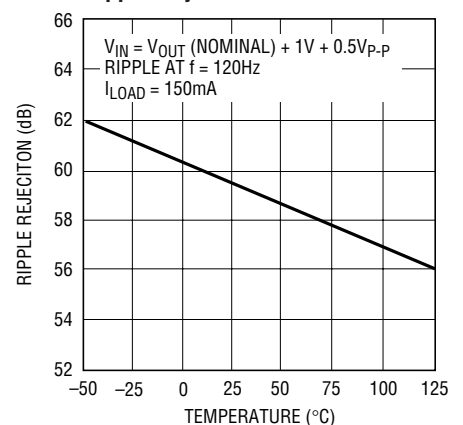

LT1521 • TPC30

TYPICAL PERFORMANCE CHARACTERISTICS

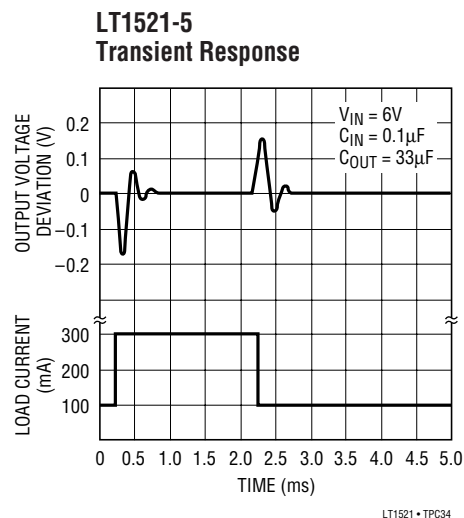

PIN FUNCTIONS

OUT (Pin 1): The output pin supplies power to the load. A minimum output capacitor of $1.5\mu\text{F}$ is required to prevent oscillations, but larger values of output capacitor will be necessary to deal with larger load transients. See the Applications Information section for more on output capacitance and reverse output characteristics.

SENSE (Pin 2): For fixed voltage versions of the LT1521 (LT1521-3, LT1521-3.3, LT1521-5), the sense pin is the input to the error amplifier. Optimum regulation will be obtained at the point where the sense pin is connected to

the output pin of the regulator. In critical applications small voltage drops caused by the resistance (R_P) of PC traces between the regulator and the load, which would normally degrade regulation, may be eliminated by connecting the sense pin to the output at the load as shown in Figure 1 (Kelvin Sense Connection). Note that the voltage drop across the external PC traces will add to the dropout voltage of the regulator. The sense pin bias current is $5\mu\text{A}$ at the nominal regulated output voltage. This pin is internally clamped to -0.6V (one V_{BE}).

PIN FUNCTIONS

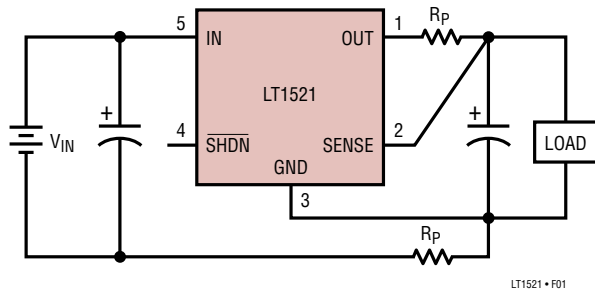

Figure 1. Kelvin Sense Connection

ADJ (Pin 2): For adjustable LT1521, the adjust pin is the input to the error amplifier. This pin is internally clamped to 6V and $-0.6V$ (one V_{BE}). It has a bias current of 50nA which flows into the pin. See Adjust Pin Bias Current vs Temperature in the Typical Performance Characteristics section. The adjust pin reference voltage is 3.75V referenced to ground. The output voltage range that can be produced by this device is 3.75V to 20V.

SHDN (Pin 5): The shutdown pin is used to put the device into shutdown. In shutdown the output of the device is turned off. This pin is active low. The device will be shut down if the shutdown pin is pulled low. The shutdown pin current with the pin pulled to ground will be 1.7 μ A. The shutdown pin is internally clamped to 7V and $-0.6V$ (one

V_{BE}). This allows the shutdown pin to be driven directly by 5V logic or by open collector logic with a pull-up resistor. The pull-up resistor is only required to supply the leakage current of the open collector gate, normally several microamperes. Pull-up current must be limited to a maximum of 5mA. A curve of the shutdown pin input current as a function of voltage appears in the Typical Performance Characteristics. If the shutdown pin is not used it can be left open circuit. The device will be active (output on) if the shutdown pin is not connected.

IN (Pin 8): Power is supplied to the device through the input pin. The input pin should be bypassed to ground if the device is more than six inches away from the main input filter capacitor. In general, the output impedance of battery rises with frequency, so it is advisable to include a bypass capacitor in battery-powered circuits. A bypass capacitor in the range of 1 μ F to 10 μ F is sufficient. The LT1521 is designed to withstand reverse voltages on the input pin with respect to ground and the output pin. In the case of reversed input, which can happen if a battery is plugged in backwards, the LT1521 will act as if there is a diode in series with its input. There will be no reverse current flow into the LT1521 and no reverse voltage will appear at the load. The device will protect both itself and the load.

APPLICATIONS INFORMATION

The LT1521 is a 300mA low dropout regulator with micropower quiescent current and shutdown. The device is capable of supplying 300mA at a dropout of 0.5V and operates with very low quiescent current (12 μ A). In shutdown, the quiescent current drops to only 6 μ A. In addition to the low quiescent current, the LT1521 incorporates several protection features which make it ideal for use in battery-powered systems. The device is protected against both reverse input voltages and reverse output voltages. In battery backup applications where the output can be held up by a backup battery when the input is pulled to ground, the LT1521 acts like it has a diode in series with its output and prevents reverse current flow.

Adjustable Operation

The adjustable version of the LT1521 has an output voltage range of 3.75V to 20V. The output voltage is set by the ratio of two external resistors as shown in Figure 2. The device servos the output voltage to maintain the voltage at the adjust pin at 3.75V. The current in R1 is then equal to 3.75V/R1. The current in R2 is equal to the sum of the current in R1 and the adjust pin bias current. The adjust pin bias current, 50nA at 25°C, flows through R2 into the adjust pin. The output voltage can be calculated using the formula in Figure 2. The value of R1 should be less than 400k to minimize errors in the output voltage caused by the adjust pin bias current. Note that in shutdown the

APPLICATIONS INFORMATION

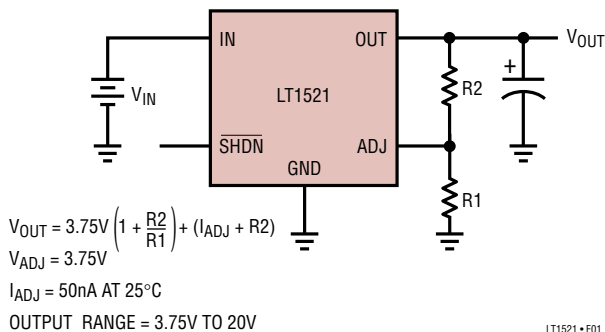

Figure 2. Adjustable Operation

output is turned off and the divider current will be zero. Curves of Adjust Pin Voltage vs Temperature and Adjust Pin Bias Current vs Temperature appear in the Typical Performance Characteristics. The reference voltage at the adjust pin has a positive temperature coefficient of approximately 15ppm/°C. The adjust pin bias current has a negative temperature coefficient. These effects will tend to cancel each other.

The adjustable device is specified with the adjust pin tied to the output pin. This sets the output voltage to 3.75V. Specifications for output voltages greater than 3.75V will be proportional to the ratio of the desired output voltage to 3.75V; ($V_{OUT}/3.75V$). For example: load regulation for an output current change of 1mA to 300mA is -20mV typical at $V_{OUT} = 3.75V$. At $V_{OUT} = 12V$, load regulation would be:

$$(12V/3.75V)(-20mV) = -64mV$$

Thermal Considerations

The power handling capability of the device will be limited by the maximum rated junction temperature (125°C). The power dissipated by the device will be made up of two components:

1. Output current multiplied by the input/output voltage differential: $I_{OUT}(V_{IN} - V_{OUT})$, and
2. Ground pin current multiplied by the input voltage: $(I_{GND})(V_{IN})$

The ground pin current can be found by examining the Ground Pin Current curves in the Typical Performance Characteristics. Power dissipation will be equal to the sum of the two components listed above.

The LT1521 series regulators have internal thermal limiting designed to protect the device during overload conditions. For continuous normal load conditions the maximum junction temperature rating of 125°C must not be exceeded. It is important to give careful consideration to all sources of thermal resistance from junction to ambient. Additional heat sources mounted nearby must also be considered.

For surface mount devices, heat sinking is accomplished by using the heat spreading capabilities of the PC board and its copper traces. Copper board stiffeners and plated through-holes can also be used to spread the heat generated by power devices.

The following tables list thermal resistance for each package. Measured values of thermal resistance for several different board sizes and copper areas are listed for each package. All measurements were taken in still air on 3/32" FR-4 board with one ounce copper. All NC leads were connected to the ground plane.

Table 1. MS8 Package

COPPER AREA		BOARD AREA	THERMAL RESISTANCE (JUNCTION-TO-AMBIENT)
TOPSIDE**	BACKSIDE		
2500mm ²	2500mm ²	2500mm ²	110°C/W
1000mm ²	2500mm ²	2500mm ²	115°C/W
225mm ²	2500mm ²	2500mm ²	120°C/W
100mm ²	2500mm ²	2500mm ²	130°C/W

* Pin 4 is ground. ** Device is mounted on topside.

Table 2. S8 Package*

COPPER AREA		BOARD AREA	THERMAL RESISTANCE (JUNCTION-TO-AMBIENT)
TOPSIDE**	BACKSIDE		
2500mm ²	2500mm ²	2500mm ²	60°C/W
1000mm ²	2500mm ²	2500mm ²	60°C/W
225mm ²	2500mm ²	2500mm ²	68°C/W
100mm ²	2500mm ²	2500mm ²	74°C/W

* Pins 3, 6, 7 are ground. ** Device is mounted on topside.

APPLICATIONS INFORMATION

Table 3. SOT-223 Package
(Thermal Resistance Junction-to-Tab 20°C/W)

COPPER AREA		BOARD AREA	THERMAL RESISTANCE (JUNCTION-TO-AMBIENT)
TOPSIDE*	BACKSIDE		
2500mm ²	2500mm ²	2500mm ²	50°C/W
1000mm ²	2500mm ²	2500mm ²	50°C/W
225mm ²	2500mm ²	2500mm ²	58°C/W
100mm ²	2500mm ²	2500mm ²	64°C/W
1000mm ²	1000mm ²	1000mm ²	57°C/W
1000mm ²	0	1000mm ²	60°C/W

* Tab of device attached to topside copper.

Calculating Junction Temperature

Example: Given an output voltage of 3.3V, an input voltage range of 4.5V to 7V, an output current range of 0mA to 150mA and a maximum ambient temperature of 50°C, what will the maximum junction temperature be?

The power dissipated by the device will be equal to:

$$I_{OUT(MAX)}(V_{IN(MAX)} - V_{OUT}) + I_{GND}(V_{IN(MAX)})$$

Where,

$$I_{OUT(MAX)} = 150\text{mA}$$

$$V_{IN(MAX)} = 7\text{V}$$

$$I_{GND} \text{ at } (I_{OUT} = 150\text{mA}, V_{IN} = 7\text{V}) = 2.1\text{mA}$$

So,

$$P = 150\text{mA}(7\text{V} - 3.3\text{V}) + (2.1\text{mA})(7\text{V}) = 0.57\text{W}$$

If we use a SOT-223 package, then the thermal resistance will be in the range of 50°C/W to 65°C/W depending on the copper area. So the junction temperature rise above ambient will be approximately equal to:

$$0.57\text{W}(60^\circ\text{C/W}) = 34.2^\circ\text{C}$$

The maximum junction temperature will then be equal to the maximum junction temperature rise above ambient plus the maximum ambient temperature or:

$$T_{JMAX} = 50^\circ\text{C} + 34.2^\circ\text{C} = 84.2^\circ\text{C}$$

Output Capacitance and Transient Performance

The LT1521 is designed to be stable with a wide range of output capacitors. A minimum output capacitor of 1.5μF

is required to prevent oscillations. The LT1521 is a micropower device and output transient response will be a function of output capacitance. See the Transient Response curves in the Typical Performance Characteristics. Larger values of output capacitance will decrease the peak deviations and provide improved output transient response for larger load current deltas. Bypass capacitors, used to decouple individual components powered by the LT1521, will increase the effective value of the output capacitor.

Protection Features

The LT1521 incorporates several protection features which make it ideal for use in battery-powered circuits. In addition to the normal protection features associated with monolithic regulators, such as current limiting and thermal limiting, the device is protected against reverse input voltages, reverse output voltages and reverse voltages from output to input.

Current limit protection and thermal overload protection are intended to protect the device against current overload conditions at the output of the device. For normal operation, the junction temperatures should not exceed 125°C.

The input of the device will withstand reverse voltages of 20V. Current flow into the device will be limited to less than 1mA (typically less than 100μA) and no negative voltage will appear at the output. The device will protect both itself and the load. This provides protection against batteries that can be plugged in backward.

For fixed voltage versions of the device, the output can be pulled below ground without damaging the device. If the input is left open circuit or grounded, the output can be pulled below ground by 20V. The output will act like an open circuit, no current will flow out of the pin. If the input is powered by voltage source, the output will source the short-circuit current of the device and will protect itself by thermal limiting. For the adjustable version of the device, the output pin is internally clamped at one diode drop below ground. Reverse current for the adjustable device must be limited to 5mA.

APPLICATIONS INFORMATION

In circuits where a backup battery is required, several different input/output conditions can occur. The output voltage may be held up while the input is either pulled to ground, pulled to some intermediate voltage or is left open circuit. Current flow back into the output will vary depending on the conditions. Many battery-powered circuits incorporate some form of power management. The following information will help optimize battery life. Table 4 summarizes the following information.

The reverse output current will follow the curve in Figure 3 when the input is pulled to ground. This current flows through the output pin to ground. The state of the shutdown pin will have no effect on output current when the input pin is pulled to ground.

In some applications it may be necessary to leave the input on the LT1521 unconnected when the output is held high. This can happen when the LT1521 is powered from a

rectified AC source. If the AC source is removed, then the input of the LT1521 is effectively left floating. The reverse output current also follows the curve in Figure 3 if the input pin is left open. The state of the shutdown pin will have no effect on the reverse output current when the input pin is floating.

When the input of the LT1521 is forced to a voltage below its nominal output voltage and its output is held high, the output current will follow the curve shown in Figure 3. This can happen if the input of the LT1521 is connected to a discharged (low voltage) battery and the output is held up by either a backup battery or by second regulator circuit. When the input pin is forced below the output pin or the output pin is pulled above the input pin, the input current will typically drop to less than $2\mu\text{A}$ (see Figure 4). The state of the shutdown pin will have no effect on the reverse output current when the output is pulled above the input.



Figure 3. Reverse Output Current



Figure 4. Input Current

APPLICATIONS INFORMATION

Table 4. Fault Conditions

INPUT PIN	SHDN PIN	OUTPUT/SENSE PINS	RESULTING CONDITIONS
$< V_{OUT}$ (Nominal)	Open (High)	Forced to V_{OUT} (Nominal)	Reverse Output Current $\approx 5\mu\text{A}$ (See Figure 3) Input Current $\approx 1\mu\text{A}$ (See Figure 4)
$< V_{OUT}$ (Nominal)	Grounded	Forced to V_{OUT} (Nominal)	Reverse Output Current $\approx 5\mu\text{A}$ (See Figure 3) Input Current $\approx 1\mu\text{A}$ (See Figure 4)
Open	Open (High)	$> 1\text{V}$	Reverse Output Current $\approx 5\mu\text{A}$ (See Figure 3)
Open	Grounded	$> 1\text{V}$	Reverse Output Current $\approx 5\mu\text{A}$ (See Figure 3)
$\leq 0.8\text{V}$	Open (High)	$\leq 0\text{V}$	Output Current = 0
$\leq 0.8\text{V}$	Grounded	$\leq 0\text{V}$	Output Current = 0
$> 1.5\text{V}$	Open (High)	$\leq 0\text{V}$	Output Current = Short-Circuit Current
$-20\text{V} < V_{IN} < 20\text{V}$	Grounded	$\leq 0\text{V}$	Output Current = 0

PACKAGE DESCRIPTION

MS8 Package 8-Lead Plastic MSOP

(Reference LTC DWG # 05-08-1660)

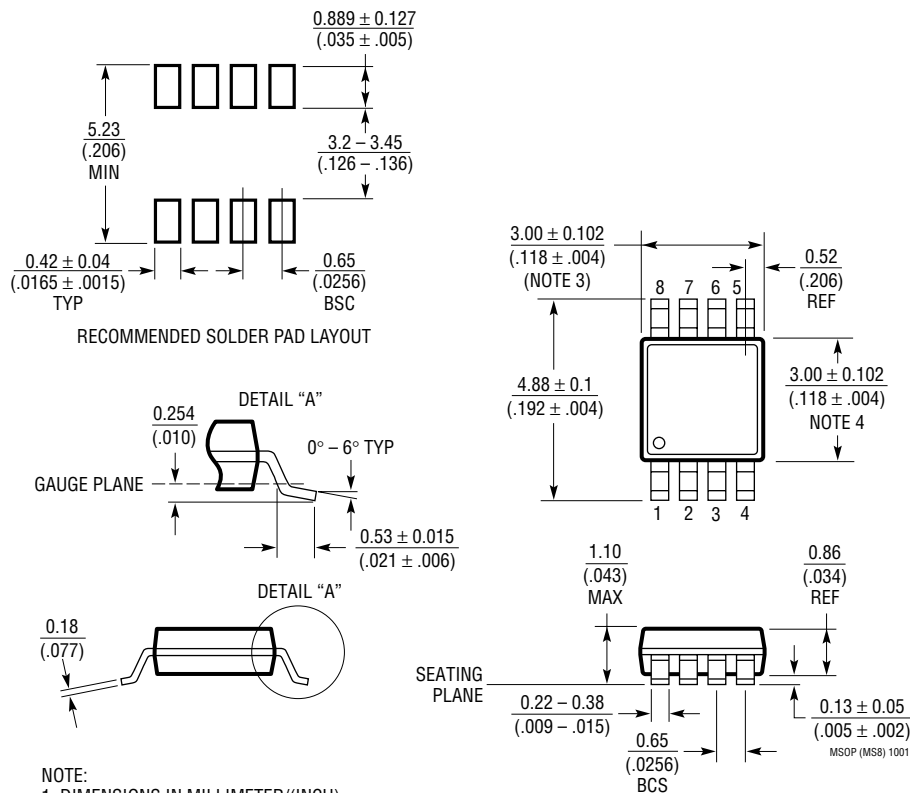

NOTE:

1. DIMENSIONS IN MILLIMETER/(INCH)
2. DRAWING NOT TO SCALE
3. DIMENSION DOES NOT INCLUDE MOLD FLASH, PROTRUSIONS OR GATE BURRS.
MOLD FLASH, PROTRUSIONS OR GATE BURRS SHALL NOT EXCEED 0.152mm ($.006$) PER SIDE
4. DIMENSION DOES NOT INCLUDE INTERLEAD FLASH OR PROTRUSIONS.
INTERLEAD FLASH OR PROTRUSIONS SHALL NOT EXCEED 0.152mm ($.006$) PER SIDE
5. LEAD COPLANARITY (BOTTOM OF LEADS AFTER FORMING) SHALL BE 0.102mm ($.004$) MAX

PACKAGE DESCRIPTION

S8 Package
8-Lead Plastic Small Outline (Narrow .150 Inch)
 (Reference LTC DWG # 05-08-1610)

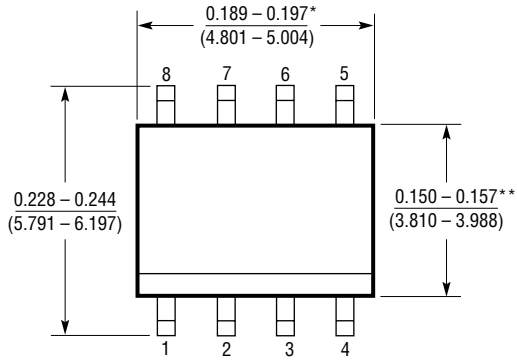

*DIMENSION DOES NOT INCLUDE MOLD FLASH. MOLD FLASH SHALL NOT EXCEED 0.006" (0.152mm) PER SIDE
 **DIMENSION DOES NOT INCLUDE INTERLEAD FLASH. INTERLEAD FLASH SHALL NOT EXCEED 0.010" (0.254mm) PER SIDE

S08 1298

PACKAGE DESCRIPTION

ST Package
3-Lead Plastic SOT-223
 (Reference LTC DWG # 05-08-1630)

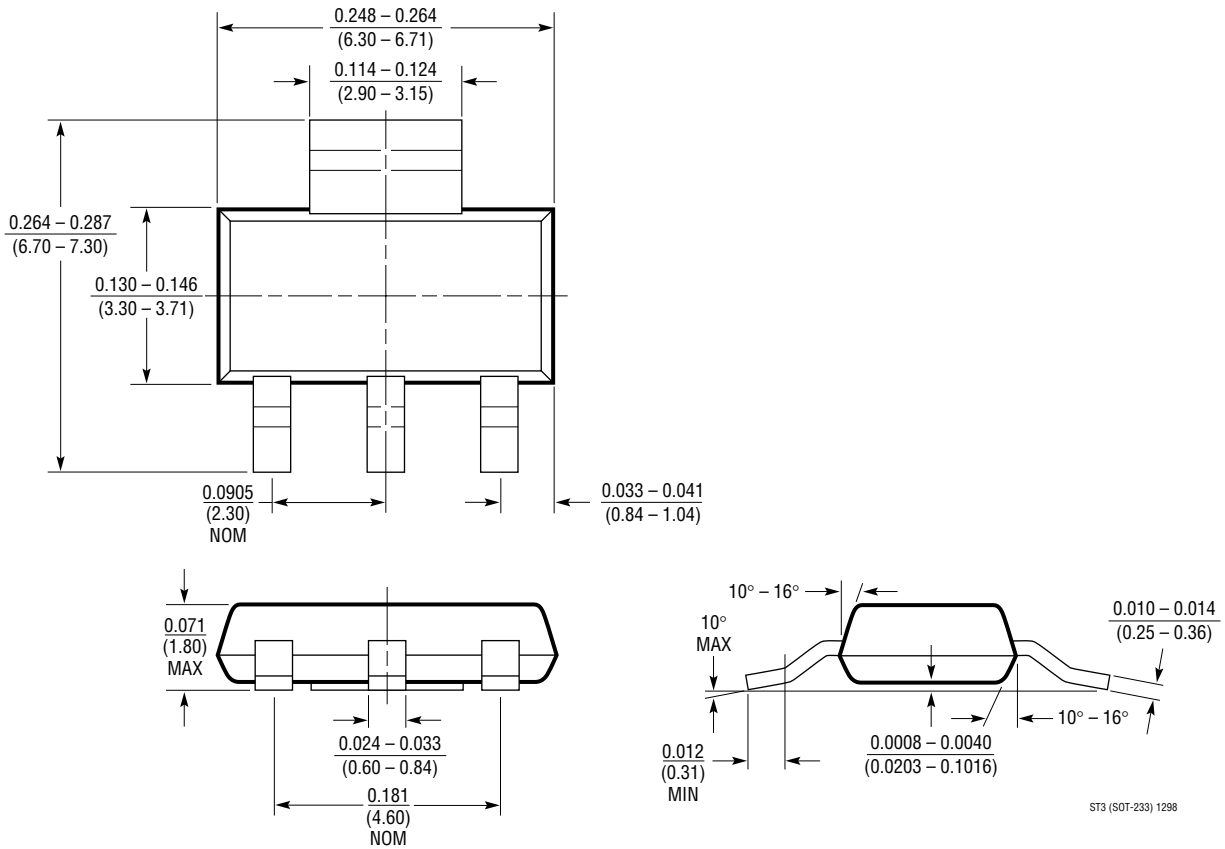

ST3 (SOT-223) 1298

RELATED PARTS

PART NUMBER	DESCRIPTION	COMMENTS
LTC®1174	425mA High Efficiency Step-Down Switching Regulator	>90% Efficiency, SO-8 Package
LT1175	500mA Micropower Low Dropout Negative Linear Regulator	Selectable Current Limit
LT1120A	125mA Micropower Low Dropout Linear Regulator	20µA Quiescent Current, Includes Comparator
LT1304	Micropower Step-Up DC/DC Converter	15µA Quiescent Current, 1.5 Minimum Input
LT1529	3A Micropower Low Dropout Regulator	50µA Quiescent Current
LT1761	100mA Low Noise Micropower Low Dropout Regulator	$I_Q = 30\mu\text{A}$, Low Noise $20\mu\text{V}_{\text{RMS}}$, $V_{\text{IN}} = 1.8\text{V to } 20\text{V}$, ThinSOT®
LT1762	150mA Low Noise Micropower Low Dropout Regulator	$I_Q = 30\mu\text{A}$, Low Noise $20\mu\text{V}_{\text{RMS}}$, $V_{\text{IN}} = 1.8\text{V to } 20\text{V}$, MSOP-8
LT1763	500mA Low Noise Micropower Low Dropout Regulator	$I_Q = 30\mu\text{A}$, Low Noise $20\mu\text{V}_{\text{RMS}}$, $V_{\text{IN}} = 1.8\text{V to } 20\text{V}$, SO-8
LT1962	300mA Low Noise Micropower Low Dropout Regulator	$I_Q = 30\mu\text{A}$, Low Noise $20\mu\text{V}_{\text{RMS}}$, $V_{\text{IN}} = 1.8\text{V to } 20\text{V}$, MSOP-8

ThinSOT is a registered trademark of Linear Technology Corporation.

Looking for pricing, stock, or lifecycle information?

Click below to explore more details on WIN SOURCE:

 [View LT1521CS8#PBF on WIN SOURCE](#)

 [Linear Technology](#) Information

Optimize Your Supply Chain with WIN SOURCE Solutions

-  Global Sourcing Solution
-  Obsolete Management
-  Cost Control Management
-  Shortage Management
-  Alternative Solution
-  Excess Inventory Management