



THE DATASHEET OF CER0645A



Features

- Low Insertion loss
- High rejection

Description

Surface mount, silver (Ag) coated ceramic duplexer.

Weight: Approximately TBD grams typical

Material: Filter is composed of a ceramic block plated with Ag and a shield made of tin plated steel.

Filter complies with RoHS standards.



Electrical Specifications

Parameter	Frequency MHz	Typical @ 25°C	Specification @ 25°C	Spec over -40°C to +85°C
Low Band Response				
Passband loss	1525 - 1559	-1.60	-1.85	-2.00
Passband Ripple	1525 - 1559	0.60	0.90	1.00
Passband Return Loss @ Port 1	1525 - 1559	-17.00	-15.00	-15.00
Passband Return Loss @ Port 2	1525 - 1559	-17.00	-15.00	-15.00
Attenuation	1626.5 - 1660.6	-62.00	-55.00	-55.00
High Band Response				
Passband loss	1626.5 - 1660.6	-1.70	-2.05	-2.20
Passband Ripple	1626.5 - 1660.6	0.60	0.90	1.00
Passband Return Loss @ Port 1	1626.5 - 1660.6	-17.00	-15.00	-15.00
Passband Return Loss @ Port 2	1626.5 - 1660.6	-17.00	-15.00	-15.00
Attenuation	1525 - 1559	-62.00	-60.00	-60.00
	2761 - 2890	-21.50	-20.00	-20.00
Isolation				
Rejection @ Low Band	1626.5 - 1660.6	-62.00	-60.00	-60.00
Rejection @ High Band	1525 - 1559	-62.00	-55.00	-55.00
Power Into any Port		3 Watt max		

Note: Supplier shall test each filter to the critical electrical specifications of the above table. Any subsequent audits may deviate from in value due to measurement repeatability among different test systems. Such deviations shall not exceed the following limits:

Specification Allowance	
Insertion Loss	0.1 dB
Return Loss	1.0 dB
Stopbands	1.0 dB

*This product is covered by one or more of the following U.S. and foreign patents including: US 4,692,726;US 4,742,562; US 4,800,348;US 4,829,274;US 5,146,193;EP 0573597;DE 0573597;FR 0573597;JP 508149/92;KR 142171;US 5,162,760;US 5,218,329;US 5,250,916;US 5,327,109;US 5,488,335;CA 2114029;FR 9306297;GB 2273393;JP 3205337;KR 115113;CN 93106228.4;US 5,512,866;EP 0706719;DE 0706719;FR 0706719;GB 0706719;CN 95190359.4;US 5,602,518;US 5,721,520;US 5,745,018;EP 0910875;DE 0910875;DK 0910875;FR 0910875;GB 0910875;IE 0910875;JP 505182/98;KR 10-323013;US 5,994,978;US 6,462,629;CN 00810420.4;US 6,559,735;US 6,650,202;US 6,834,429.Other US and foreign patents pending.

CTS Corporation 2006 reserves all copyrights in the layout, design and configuration of the patterns on this product.

Mechanical Drawing

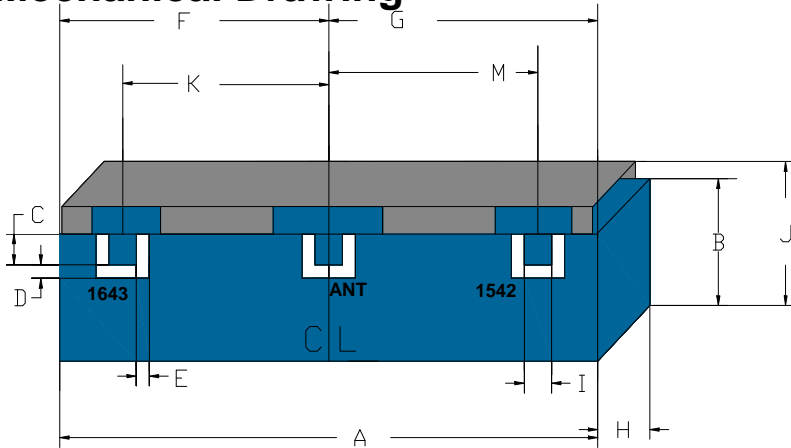

Dim	Nominal (mm)	Tolerance (mm) +/- or max
A	24.00	max
B	7.00	max
C	1.02	0.13
D	1.02	0.25
E	1.02	0.13
F	11.87	0.13
G	11.87	0.13
H	4.60	max
I	1.02	0.13
J	8.00	max
K	9.90	0.13
M	9.90	0.13

PCB Layout

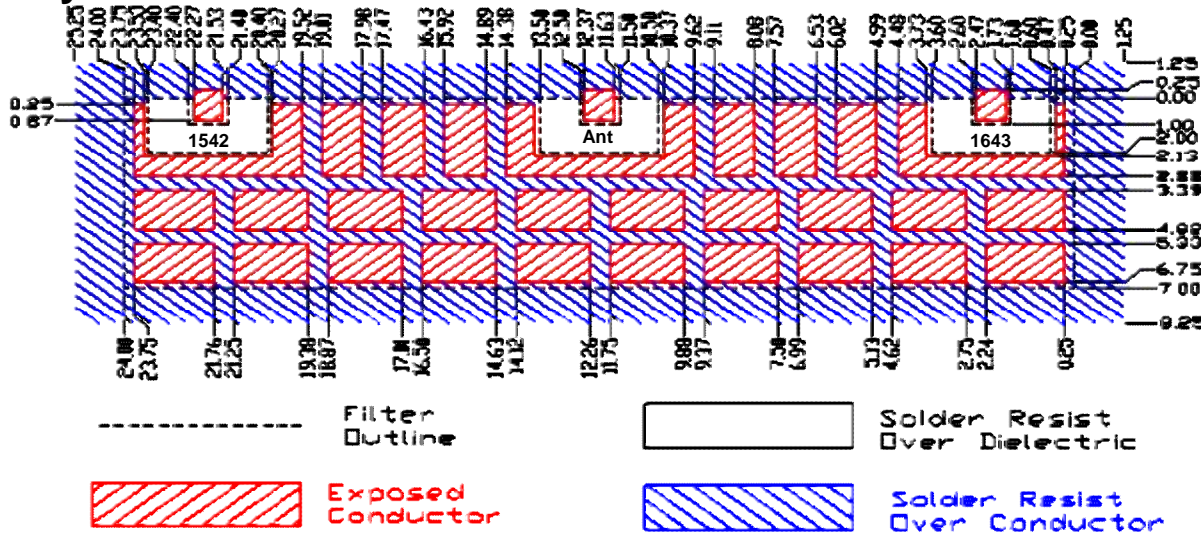

Packaging and Marking

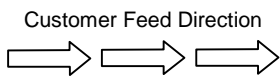

DIMENSION	UNITS	SPECIFICATION
REEL DIAMETER	mm	330
REEL WEIGHT	kg	2.3
REEL QUANTITY	ea.	500

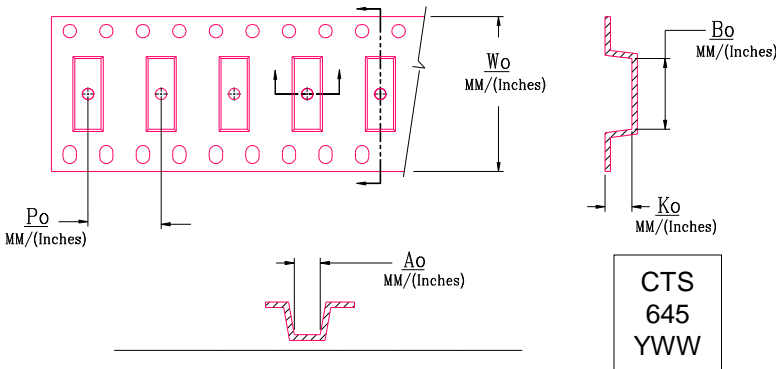

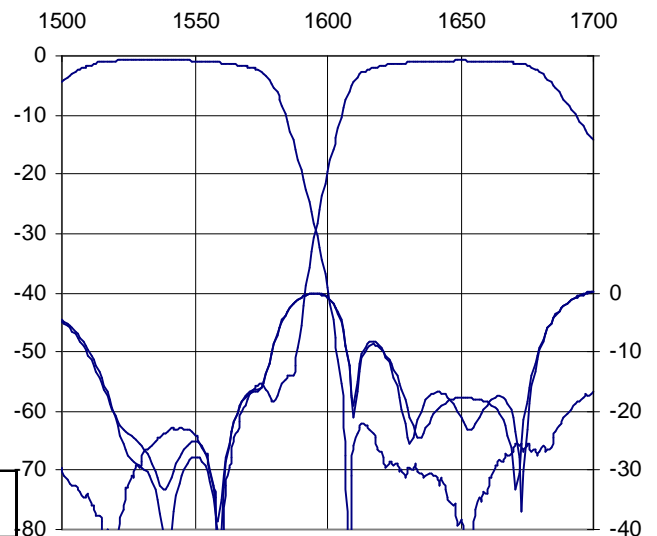

Wo	Ao	Bo	Ko	Po
Inches/mm	Inches/mm	Inches/mm	Inches/mm	Inches/mm
1.732" / 44.0	0.329" / 8.53	0.960" / 24.35	0.195" / 4.95	0.472" / 12.0

Electrical response



Looking for pricing, stock, or lifecycle information?

Click below to explore more details on WIN SOURCE:

-  [View CER0645A on WIN SOURCE](#)
-  [Tusonix a Subsidiary of CTS Electronic Components Information](#)

Optimize Your Supply Chain with WIN SOURCE Solutions

-  Global Sourcing Solution
-  Obsolete Management
-  Cost Control Management
-  Shortage Management
-  Alternative Solution
-  Excess Inventory Management